

Contents

Updates.....	3
Introduction	4
Product overview	5
Program WM60.3.....	7
Program WM60.2.....	9
Program WM60.1	10
Program selection, options and making settings WM60.3.....	13
Select program 60.3.....	14
Select Option WM60.3	15
Making settings WM60.3	17
Selecting program WM60.2.....	20
Selecting options WM60.2.....	20
Making settings WM60.2	21
Selecting program WM60.1	22
Selecting options WM60.1	23
Making settings WM60.1	24
Service menu WM60.3.....	25
Service menu WM60.2.....	29
Service menu WM60.1	30
Shop program WM60.3.....	31
Shop program WM60.2 och WM60.1	31
Fault indications WM60.3.....	32
Fault indications WM60.2.....	33
Fault indications WM60.1	34
Components and measurement values WM60.....	35
Measurement values thermistor	35
Technical data WM60.....	36
Tools.....	36
Wiring diagram WM60.3.....	37
Wiring diagram WM60.2.....	38
Wiring diagram WM60.1	39
Rehanging the door.....	40
Replacing panels and detergent compartment.....	43
Replacing front panel, door, cover plate and the hinges.....	45
Emergency opener for door lock.....	46
Timer diagram WM60.3	47
Notes.....	49

This service manual describes washing machine type WM60 and is a supplement to the general service manual for the 600 series.



Updates

Revision	Date	Description	Signature
03	2007-11-21	Updated the "Show room program" /In-store demonstration program with a description for machines manufactured week 737 and later. page 17	BPA
04	2007-10-16	Updated with WM60.2. WM60.3 added Stain program	MW
05	2007-04-30	Updated with WM60.1	MAS

Introduction

You are holding the service manual for WM60 type washing machines. It should be easy to service a washing machine. It is important that you, as a service technician, are given the conditions to be able to carry out work in an efficient and satisfactory way. Our hope is that this service manual is a useful tool for your daily work. The type designation is located by the inside of the glass door (see image below).

Asko Appliances AB
SE-534 82 Vara
Sweden

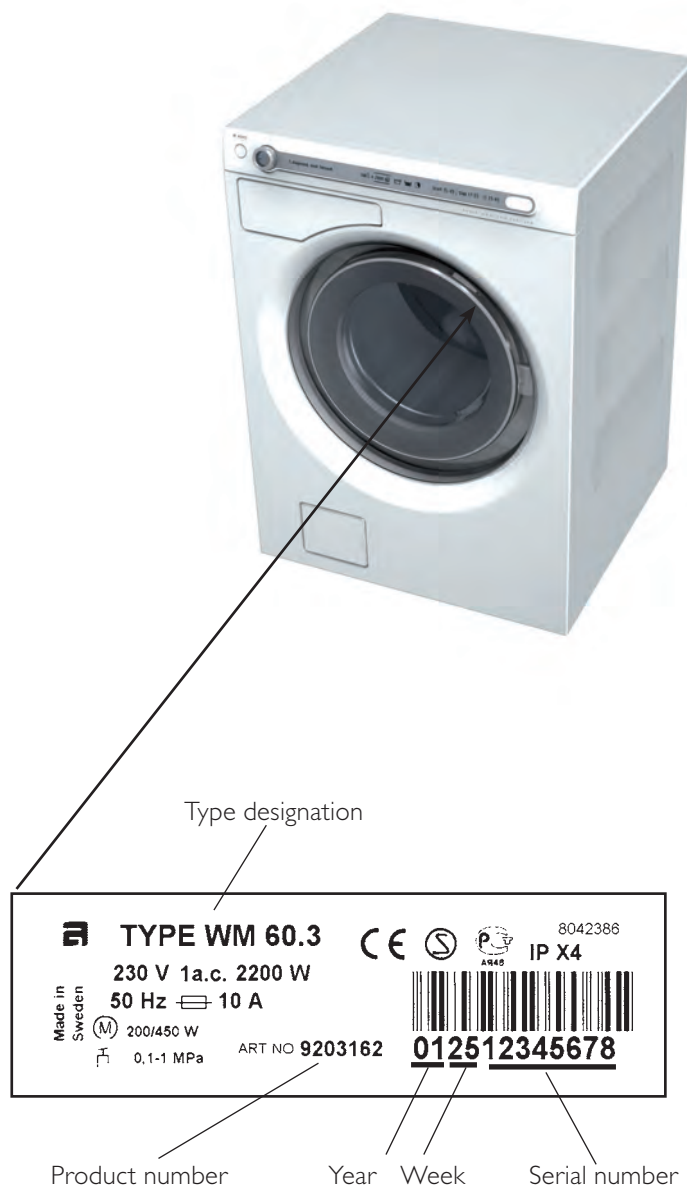

Product overview WM60.3

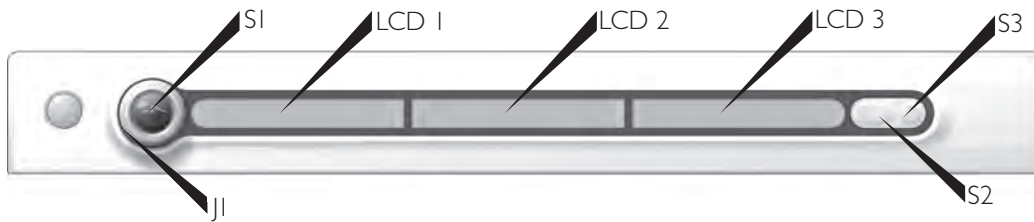

Programs: 14, where one consists of the menu for settings (Program 14)
for V826, it is possible to add a program(stain program)

Options: 6

Settings: 8

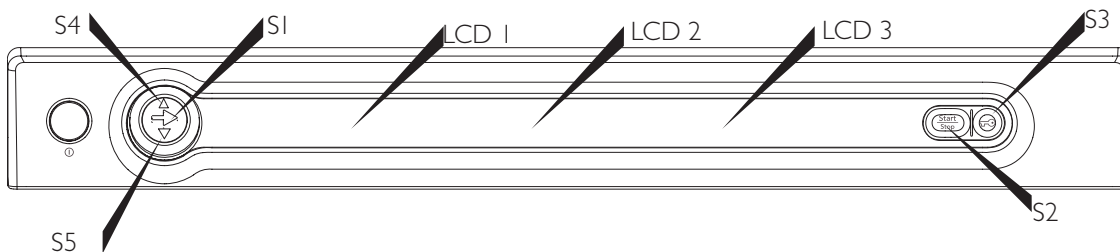

Programs: 14, where one consists of the menu for settings (Program 14)
for V826, it is possible to add a program(stain program)

Options: 6

Settings: 8

WM60.2

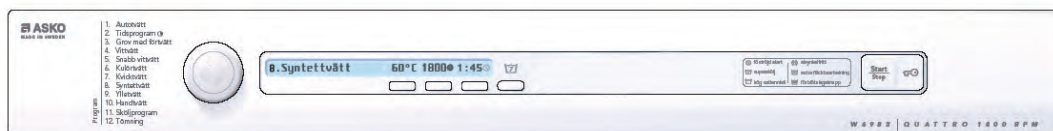

Programs: 12

Options: 1 or 5

Settings: 3

WM60.I



Programs: 10
Options: 4 or 6
Settings: 1

Program WM60.3

The tables present a few examples of the energy, water and time consumption of a few different programme settings. Consumption can vary according to water pressure, water hardness, water supply temperature, room temperature, load weight and content, variations in the power supply and selected options. In the examples presented here the rinse setting was set to "Normal" and no options were selected.

Program 5 rinses(with stain program)									
	Pre-wash	Main wash	Temp. °C	Max. rpm	Max. load, kg	Rinses, number	Water consumption, litres	Energy, kWh	Time, min
Program 1					7				
Program 2					7				
Program 3					7				
Program 4	X	long long	95 60	1600 1600	7 7	5 5	85 77	2,1 1,19	166 160
Program 5*		long long	60 40	1600 1600	7 7	5 5	72 72	1,19 0,66	166 149
Program 6**		short	60	1600	7	5	72	1,15	105
Program 7		short	40	1600	3,5	5	56	0,53	80
Program 8		short	40	1600	3,5	3	33	0,45	48
Program 9***		short	40	800	3,5	4	38	0,39	82
Program 10		short	30	800	2,2	3	68	0,49	46
Program 11		short	30	800	2,2	3	68	0,49	46
Program 12				1600	3,5	1	13	0,07	18
Program 13				1600	3,5			0,06	13
Program 14									1

Program 3 rinses (with stain program)									
	Pre-wash	Main-wash	Temp. °C	Max rpm	Max load kg	Rinses, number	Water consumption, litres	Energy kWh	Time min
Program 1					7				
Program 2					7				
Program 3					7				
Program 4	X	long long	95 60	1600 1600	7 7	5 5	85 77	2,10 1,19	166 160
Program 5*		long long	60 40	1600 1600	7 7	3 3	59 59	1,19 0,66	159 142
Program 6		short	60	1600	7	3	59	1,14	98
Program 8		short	40	1600	3,5	3	33	0,45	48
Program 9		short	40	800	3,5	4	38	0,39	82
Program 10		short	30	800	2,2	3	68	0,49	46
Program 11		short	30	800	2,2	3	68	0,49	46
Program 12				1600	3,5	1	13	0,07	18
Program 13				1600	3,5			0,06	13
Program 14									1

Program WM60.3 continuation

5 with (stain program)									
Program	Pre-wash	Main-Wash	Temp. °C	Max rpm	Max load kg	Rinses number	Water con-sump., litres	Energy kWh	Time min
Program 1					5				
Program 2					5				
Program 3					5				
Program 4	×	long long	95 60	1600 1600	5 5	5 5	80 72	1,6 0,96	151 153
Program 5*		long	60 40	1600 1600	5 5	5 5	67 67	0,95 0,53	141 128
Program 6**		short	60	1600	5	5	67	0,92	158
Program 7		short	40	1600	2,5	5	54	0,45	78
Program 8		short	40	1600	2,5	3	31	0,37	48
Program 9***		short	40	800	2,5	4	28	0,31	79
Program 10		short	30	800	1,6	3	68	0,49	46
Program 11		short	30	800	1,6	3	68	0,49	46
Program 12				1600	2,5	1	13	0,07	18
Program 13				1600	2,5			0,06	13
Program 14									1

* This programme has been tested in accordance with EN 60456. 40°C programme for test institutes. 40°C option must be selected.

** Short programme for test institutes. 40°C or 60°C option must be selected.

*** Synthetics programme for test institutes. The "Super rinse" option must be selected.

Program WM60.2

The tables present a few examples of the energy, water and time consumption of a few different programme settings. Consumption can vary according to water pressure, water hardness, water supply temperature, room temperature, load weight and content, variations in the power supply and selected options. In the examples presented here the rinse setting was set to "Normal" and no options were selected.

Program									
5 rinses									
	Pre-wash	Main-wash	Temp. °C	Max rpm	Max load kg	Rinses number	Water consumption, litres	Energy kWh	Time min
Program 1					7				
Program 2					7				
Program 3	×	long long	95 60	1600 1600	7 7	5 5	85 77	2,10 1,19	166 160
Program 4		long	60 40	1600 1600	7 7	5 5	72 72	1,19 0,66	166 149
Program 5*		short	60	1600	7	5	72	1,15	105
Program 6**		short	40	1600	3,5	5	56	0,53	80
Program 7		short	40	1600	3,5	2	26	0,45	43
Program 8		short	40	800	3,5	3	31	0,39	76
Program 9***		short	30	800	2,2	3	68	0,49	46
Program 10				1600	3,5	1	13	0,07	18
Program 11				1600	3,5			0,06	13
Program 12									1

Program									
3 rinses									
	Pre-wash	Main-wash	Temp. °C	Max. rpm	Max load kg	Rinses number	Water consumption, litres	Energy kWh	Time min
Program 1					7				
Program 2					7				
Program 3	×	long long	95 60	1600 1600	7 7	5 5	85 77	2,10 1,19	166 160
Program 4		long	60 40	1600 1600	7 7	3 3	59 59	1,19 0,66	159 142
Program 5*		short	60	1600	7	3	59	1,14	98
Program 6**		short	40	1600	3,5	3	45	0,52	73
Program 7		short	40	1600	3,5	2	26	0,45	43
Program 8		short	40	800	3,5	3	31	0,39	76
Program 9***		short	30	800	2,2	3	68	0,49	46
Program 10				1600	3,5	1	13	0,07	18
Program 11				1600	3,5			0,06	13
Program 12									1

Program WM60.2 continuation

Program		5 rinses							
	Pre-wash	Main-wash	Temp. °C	Max rpm	Max load kg	Rinses number	Water consumption, litres	Energy kWh	Time min
Program 1					5				
Program 2					5				
Program 3	×	long long	95 60	1600 1600	5 5	5 5	80 72	1,6 0,96	166 160
Program 4		long long	60 40	1600 1600	5 5	5 5	67 67	0,95 0,53	141 128
Program 5*		short	60	1600	5	5	67	0,92	98
Program 6**		short	40	1600	2,5	5	54	0,45	78
Program 7		short	40	1600	2,5	2	24	0,37	43
Program 8		short	40	800	2,5	3	23	0,31	74
Program 9***		short	30	800	1,6	3	68	0,49	46
Program 10				1600	2,5	1	13	0,07	18
Program 11				1600	2,5			0,06	13
Program 12									1

* This programme has been tested in accordance with EN 60456. 40°C programme for test institutes. 40°C option must be selected.

** Short programme for test institutes. 40°C or 60°C option must be selected.

*** Synthetics programme for test institutes. The "Super rinse" option must be selected.

Program WM60.1

The above table presents a few examples of the energy, water and time consumption of a few different programme settings. Consumption can vary according to water pressure, water hardness, water supply temperature, room temperature, load weight and content, variations in the power supply and selected options. In the examples provided here the rinse setting is set to Normal and no options are selected.

Program		5 rinses							
	Pre-wash	Main-wash	Temp. °C	Max rpm	Max load kg	Rinses number	Water consumption, litres	Energy kWh	Time min
Program 1*					7				
Program 2	Yes	long	95	1600	7	5	85	2,10	166
	Tes	long	60	1600	7	5	77	1,19	160
Program 3**	No	long	60	1600	7	5	72	1,19	166
	No	long	40	1600	7	5	72	0,66	149
Program 4	No	short	60	1600	7	5	72	1,15	165
Program 5	No	short	40	1600	3,5	2	26	0,45	43
Program 6	No	short	40	1200	3,5	2	52	0,52	80
Program 7	No	short	40	800	3,5	3	31	0,39	76
Program 8	No	short	30	800	2,2	3	68	0,49	46
Program 9	No			1600	3,5	1	13	0,07	18
Program 10				1600	3,5			0,06	13

Program WM60.I continuation

Program									
3 rinses									
	Pre-wash	Main-wash	Temp. °C	Max rpm	Max load kg	Rinses number	Water consumption, litres	Energy kWh	Time min
Program 1*					7				
Program 2	Yes	long	95	1600	7	5	85	2,10	166
	Yes	long	60	1600	7	5	77	1,19	160
Program 3**	No	long	60	1600	7	3	59	1,19	159
	No	long	40	1600	7	3	59	0,66	142
Program 4	No	short	60	1600	7	3	59	1,14	88
Program 5	No	short	40	1600	3,5	2	26	0,45	43
Program 6	No	short	40	1200	3,5	2	52	0,52	80
Program 7	No	short	40	800	3,5	3	31	0,39	76
Program 8	No	short	30	800	2,2	3	68	0,49	46
Program 9	No			1600	3,5	1	13	0,07	18
Program 10				1600	3,5			0,06	13

Program									
5 rinses									
	Pre-wash	Main-wash	Temp. °C	Max rpm	Max load kg	Rinses number	Water consumption, litres	Energy kWh	Time min
Program 1*					7				
Program 2	Yes	long	95	1600	7	5	80	1,60	151
	Yes	long	60	1600	7	5	72	0,96	153
Program 3**	No	long	60	1600	7	5	67	0,95	141
	No	long	40	1600	7	5	67	0,53	128
Program 4	No	short	60	1600	7	5	67	0,92	98
Program 5	No	short	40	1600	3,5	2	26	0,45	43
Program 6	No	short	40	1200	3,5	2	52	0,52	80
Program 7	No	short	40	800	3,5	3	31	0,39	76
Program 8	No	short	30	800	2,2	3	68	0,49	46
Program 9	No			1600	3,5	1	13	0,07	18
Program 10				1600	3,5			0,06	13

* Short programme for test institutes, max. half load.

** Test programme in accordance with EN60456. 40°C for test institutes. 40°C option must be selected.

Program	Machine type			
	WM60.3	WM60.3 fr o m 826	WM60.2	WM60.1
Auto	X	X	X	X
Stain program		X selectable		
Time program	X	X	X	
Heavy	X	X	X	X
Normal white/colour	X	X	X	X
Quick white/colour				X
White quick	X	X	X	
Colour quick	X	X	X	
Superquick	X	X	X	X
Easy care/Sportswear				X
Synthetics	X	X	X	X
Wool	X	X		
Hand	X	X		
Wool/Handwash			X	X
Rinse	X	X	X	X
Spin/Drain				X
Spin	X	X	X	
Drain	X	X	X	

Program selection, options and making settings WM60.3

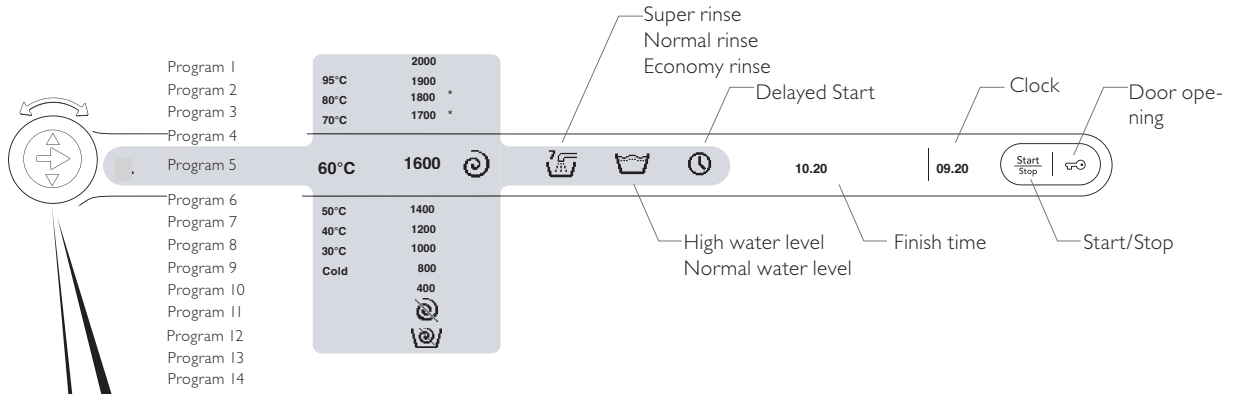

Program selector





1. Press the program selector button to navigate between the different menus (e.g. to go from temperature menu to spin menu).
2. Press the small arrows to make a selection in the menus (e.g. select 1400 rpm). Confirm the selection and go to the next menu by pressing the program selector button.
3. Press Start/Stop to start. Hold Start/Stop in for 3 seconds to exit the current program.

Program selector for integrated machines

1. Press the program selector button to navigate between the different menus (e.g. to go from temperature menu to spin menu).
2. Turn the program selector button to make a selection in the menus (e.g. select 1400 rpm). Confirm the selection and go to the next menu by pressing the program selector button.
3. Press Start/Stop to start. Hold Start/Stop in for 3 seconds to exit the current program.



























Selecting program 60.3

The options are displayed in the order they occur in LCD2. All display text language versions are displayed.

Press/ turn	Pos.	LCD 1	Comments/instruction
			Turn on the main power
 	1	Auto, Auto, Auto, Automatprogram, Auto- vask, Autovask, Automaattipesu, Automati- que, Automatikprogramm, Automatico, Auto, Автоматическая , Automatisch programma	This program automatically adjusts the length of the main wash and the number of rinses depending on the amount of washing and how heavily soiled it is.
	2	Stain Care, Stain prog, Fläckprogram, Plet program, Flekkprogram, Tahraohjelma, Tache, Flecken-Progr., Prog Antimacchia, Manchas, Пятна, Vlekkenprog.	A special program for stains. Stain removal requires attention as soon as possible.
	3	Time program, Time Choice, Time program, Tidsprogram, Tidsprogram, Tidsprogram, Ai- kaohjelma, Programme minute, Zeitprogramm, Prog. del tempo , Prog. de secado,Время окончани, Tijdprogramma	Choose a temperature up to 60°C/ 140 °F, set the spin speed to a maximum of 1600 rpm and set the time when you want the program to finish. The machine will automatically choose a program of the right length with the settings you have selected.
	4	Heavy, Sani, Heavy, Grov- med förtvätt, Kogevask+forvask, Intensiv m/forvask, Esipesu + Tehopesu, Super intensif, Vor-/Kochwäsche, Intensivo, Sani, Интенсивная , Intensieve was	Use this program for heavily-soiled washing. You only need to use the maximum temperature, 60°C/ 140 °F, if the washing is very heavily soiled.
	5	Normal, Stain, Normal, Vittvätt, Hvidvask, Intensiv, Tehopesu, Super intensif blanc, Intensiv, Intensivo bianchi, Manchas-Color, Нормальная, Normale was	This program is equivalent to the Heavy program, but without the pre-wash. It is used for heavily-soiled whites where 95°C/ 203 °F is a suitable temperature.
	6	White, White, White, Snabb vittvätt, Hurtig hvidvask, Hvit, Normaalipesu, Intensif, Koch- wäsche, Capi resistenti, Pesado, Белое, Witte was	Normally-soiled sheets, pillowcases and towels will come clean at 60 °C/140 °F.
	7	Colour, Color, Colour, Kulörtvätt, Kulört vask, Kulør, Päivittäipesu, Blanc/couleurs, Buntwäsche, Bianchi/colorati, Normal Plus, Цветное, Bonte was	Clothes worn next to the skin should be washed at 60°C/ 140 °F. Lightly-soiled laundry can be washed at 40°C. Most modern detergents are effective even at 40°C.
	8	Quick, Quick, Quick, Kvicktvätt, Kvikkvask, Hurtig, Pikapesu, Rapide, Schnell, Rapido, Rápido, Быстрая стирка, Kort programma	Lightly soiled laundry that only needs freshening up can be washed for a short time at 40°C.
	9	Synthetics, PermaPress, Synthetics, Syntettvätt, Syntetisk vask, Syntet, Siliävät/Synteettiset, Synt- hétique, Pflegeleicht/Fein, Sintetici, Perma Press, Синтетика, Synthetische was	This program is suitable for shirts and blouses made of synthetic and blended material. Wash white items at 60°C/ 140 °F and coloured items at 40°C/ 104 °F.
	10	Wool, Wool, Wool, Ylletvätt, Uldvask, Ull, Vil- lapesu, Laine, Wolle, Lana, Lavado manual/Lana, Шерсть, Wolwas	This program is used for garments labelled for Wool wash only. The maximum temperature is 40°C/ 104 °F and the program has a short spin.
	11	Hand, Delicate / Hand, Hand, Handtvätt, Hånd- vask, Hånd, Käsinpesu, Main, Hand, A mano/deli- cati, Delicado, Ручная стирка, Handwas	This program is used for garments labelled hand wash only. The maximum temperature is 30°C/ 86 °F and the program has a short spin.
	12	Rinse, Rinse, Rinse, Sköljprogram, Skylleprogram, Skyling, Huuhteluohjelma, Rinçage, Spülen, Risci- acqua, Enjuague,Полоскани, Spoelprogramma	This program performs one rinse cycle + spin. Good for cleaning cloths and mops.
	13	Spin, Spin, Spin, Centrifugering, Centrifugering, Sentrifugering, Linkous, Essorage, Schleudern, Centrifuga, Centrifugado, Отжим, Centrifugeren	To be used when you only want to spin the load.
	14	Drain, Drain, Drain, Utpumpning, Udpumpning, Utpumping, Tyhjennys, vidange, Abpumpen, Scarico, Drenaje, Слив, Pompen	To be used when you only want to drain the water from the machine.
	15	Settings, Settings, Settings, Inställningar, Indstillin- ger, Innstillinger, Asetukset, Réglage, Einstellungen, Impostazioni, Ajustes, Настройки, Instellingen	See chapter "Settings".
			Exits the program menu and advances to options or the menu for Settings.

Selecting options WM60.3

The options are displayed in the order they occur in LCD2. All display text language versions are displayed.

















Press/	LCD 2	Comments/Instructions	
 	95°C	 Temperatur Temperature Selection of temperatures between Cold and 95°C. Cold is the same as the incoming water temperature. For program 8 and 9, the maximum temperature is 40°C, for program 10, the maximum temperature is 60°C.	
	80°C		
	70°C		
	60°C		
	50°C		
	40°C		
	30°C		
	Cold, Cold, Cold, Kalt, Kold, Kald, Kylmä, Froid, Kaltt, Freddo, Fría, Доп.полоскани, Koud		
			
 	2000 	 Spin Option of choosing spin speed between 400 and 2000 rpm. Spinning at 400 – 800 rpm signifies a short spin. Program 8, 9 and 10 cannot be selected at speeds greater than 800 rpm. Program 2 has a maximum speed of 1600 rpm. Maximum rpm is either 1800 or 2000 rpm depending on model.	
	1900 		
	1800 		
	1700 		
	1600 		
	1500 		
	1400 		
	1200 		
	1000 		
	800 		
	400 		
			"No spin" means that the program does not include a spin cycle and ends by draining.
			"No draining" means that the program does not include a spin cycle and ends with the water from the final rinse still in the machine.
			
 	 Economy Rinse, Economy Rinse, Economy Rinse, Lätt sköljning, Økonomi skyl, Økonomi skylling, Ekohuuhtelut, Rinçage économique, Eco Spülen, Risciacquo economico, Enjuague económico, Норм. полоскание, Eco spoelen	Rinse The rinse program can be selected in program: 4, 5, 6, 7, 8, 9 and 11 - Economy rinse (reduces the number of rinses, used for lightly soiled laundry) - Normal rinse (recommended number of rinses during normal soiled laundry.) - Super rinse (adds rinses, maximum 7) Number of rinses varies depending on program.	
	 Normal Rinse, Normal Rinse, Normal Rinse, Normal sköljning, Normalt skyl, Normali huuhtelut, Rinçage normal, Normal Spülen, Risciacquo normale, Enjuague normal, Норм.полоскание, Normaal spoelen		
	 Super Rinse, Super Rinse, Super Rinse, Supersköljning, Superskyl, Superskyl, Superhuuhtelut, Super rinçage, Super Spülen, Risciacquo super, Superenjuague, перполоскание, Super spoelen		

Selecting options WM60.3

















Press/turn	LCD 2	Comments/instructions
	Normal water level, Normal Water Level, Normal water level, Normal vattennivå, Normal vandstand, Normalt vannivå, Normaali vedenpinta, Niveau d'eau normale, Normaler Wasserstand, Livello acqua normale, Nivel normal de agua, Норм.уровень вод, Normaal waterniveau	High water level Can be selected in programs: 3, 4, 5, 6, 7 and 8. Cannot be selected during No spin and No draining. With this option selected, extra water is taken in after approximately 15 minutes, the extra water is used in the main wash and rinses.
	High water level, High Water Level, High water level, Hög vattennivå, Høj vandstand, Høyt vannivå, Korkea vedenpinta, Niveau d'eau élevé, Hoher Wasserstand, Livello acqua alto, Nivel alto de agua, Высокий уровень воды, Hoog waterniveau	
	Start, Start, Start, Start, Start, Start, Start, Démarrer, Start, Avvio, Inicio, Старт, Start	Delayed start (when setting: "No Real time") The start of the selected program can be delayed for up to 24 hours (in half an hour intervals). The delay and program time is shown in the display.
	Start - Done, Start-End, Start-Done, Start-Klar, Start-Færdig, Start-Ferdig, Start-Valmis, Démarrer-Fin, Start-Fertig, Avvio-Fine, Inicio-Fin, Старт-Конец, Start-Gereed	Delayed start (when setting: "24 Hour Clock" or "12 Hour Clock") The start of the selected program can be delayed for up to 24 hours (in half an hour intervals). Start and end times are shown in the display.
	Start, Start, Start, Start, Start, Start, Start, Démarrer, Start, Avvio, Inicio, Старт, Start	Time program (when setting: "No Real time") Desired program time can be set. Selections up to 3 hours in units of 15 minutes can be made. The selected program time is shown in the display.
	Start - Done, Start-End, Start-Done, Start-Klar, Start-Færdig, Start-Ferdig, Start-Valmis, Démarrer-Fin, Start-Fertig, Avvio-Fine, Inicio-Fin, Старт-Конец, Start-Gereed	Time program (when setting: "24 Hour Clock" or "12 Hour Clock") Desired program time can be set. Selections up to 3 hours in units of 15 minutes can be made. Start and end times are shown in the display.

Making settings WM60.3











The setting options below are shown in the order they occur in LCD2 (Program 15 under the program menu is, however, shown in LCD1). All display text language versions are displayed. If no choices is done within 2 minutes the display will be set in Stand-by mode.

Press/turn	LCD 2	Press/turn	LCD3	Comments/instructions	
 	Settings, Settings, Settings, Inställningar, Indstillinger, Innstillinger, Asetukset, Réglage, Einstellungen, Impostazioni, Ajustes, Настройка, Instellingen			In the program menu: Scroll to Program 15 (Settings) Program 15 is shown in LCD1.	
	You will now enter the Settings menu.				
 	Presoak, Presoak, Presoak, Förblötning , Iblødsætning, Bløtlegging , Liotus, Trempage, Einweichen, Ammollo, Remojar, амачивание, Inweken				
			On, On, On, På, Til, På, Päällä, On, An, On, encendido, Вкл., Aan	The laundry will soak in cold water for two hours before the program starts.	
			Off, Off, Off, Av, Fra, Av, Poissa, Off, Aus, Off, apagado, Выкл., Uit	Setting deactivated.	
			Saves the setting and returns to the program menu, Program 15.		
	Anti crease, Anti Wrinkle, Anti crease, Skrynkelfritt, Anti-krøl, Antikrøll , Rypistymisen esto, Antifroissage, Knitterschutz, Antisgualcit., Antiarrugas, Против сминания, Anti-kreuk				
			On, On, On, På, Til, På, Päällä, On, An, On, encendido, Вкл, Aan	The drum rotates 3 seconds per minute for two hours after the program has ended	
			Off, Off, Off, Av, Fra, Av, Poissa, Off, Aus, Off, apagado, Выкл., Uit	Setting deactivated.	
			Saves the setting and returns to the program menu, Program 15		
	Clock, Clock, Clock, Klocka, Ur, Klokke, Kello, Horloge, Uhr, Orologio, Reloj, Часы, Klok				
			24hr Realtime, 24 Hour Clock, 24hr Realtime, 24 timmarsvisning, 24 timers ur, 24t realtid, 24 h aika, Horloge 24 h, 24 Std. Echtzeit, 24h Tempo reale, Reloj 24 horas, ормат времени 24- , 24 uur weergave	Three O'clock is displayed as "15.00". Press SI to access a sub-menu where you can set the correct current time. Press SI again to store and exit the sub-menu.	
			12hr Realtime, 12 Hour Clock, 12hr Realtime, 12 timmarsvisning, 12 timers ur, 12t realtid, 12 h aika, Horloge 12 h, 12 Std. Echtzeit, 12h Tempo reale, Reloj 12 horas, ормат времени12- , 12 uur weergave	Three O'clock is displayed as "03.00". Press SI to access a sub-menu where you can set the correct current time. Press SI again to store and exit the sub-menu.	
			No Real time, No Real Time, No Real time, Ej realtid, Intet ur, Ingen realtid, Ei aikaa, Pas d'horloge, Keine Echtzeit, No tempo reale, Sin hora real, Время не установлено, Geen tijdsweergave	No Real Time. Press SI to return to program menu Program 15.	
		Saves the setting and returns to the program menu, Program 15.			

Making settings WM60.3 continuation

Press/ turn	LCD 2	Press/ turn	LCD3	Comments/instruction
 	Audible volume, Buzzer Volume, Audible volume, Ljudsignal volym, Lydsignal, Lydsignal, Hälytysääni, Volume buzzer, Tonsignal, Volume allarme, Volumen timbre, Громкость сигнала, Geluidssignaal			
			Off, Off, Off, Av, Fra, Av, Poissa, Off, Aus, Off, apagado, Выкл., Uit	No buzzer
			Low, Low, Low, Låg, Lav, Lav, Matala, Faible, Niedrig, Bassa, Bajo, Низкая, Laag	Buzzer that indicates the end of a program or error.
			Normal, Normal, Normal, Normal, Normal, Normal, Normaali, Normal, Normal, Nor- male, Normal, Нормальная , Normaal	Buzzer that indicates the end of a program or error.
			High, High, High, Hög, Høj, Høy, Korkea, Elevé, Hoch, Alta, Alto, Выкл , Hoog	Buzzer that indicates the end of a program or error.
			Saves the setting and returns to the program menu, Program 15.	
	Child-safe Child-safe Barnsäker Børnesikker, Barnesikring, Lap- silukko, Sécurité enfant, Kindersi- cherung, Avvio sicurezza, Int. de seguridad, Блокировка от детей, Kindveilige			Saves the setting and returns to the program menu, Program 15.
			On, On, On, På, Til, På, Påällä, On, An, On, encendido, Вкл., Aan	If S1, S2, S3 or J1 are pressed or turned, S2 S1 must be pressed to temporarily deactivate the child-safe start (is deactivated for 3 minutes after last press of S1, S2, S3).
			Off, Off, Off, Av, Fra, Av, Poissa, Off, Aus, Off, apagado, Выкл ., Uit	Setting deactivated.
				Saves the setting and returns to the program menu, Program 15.
	Automatic door opening, Auto- matic Door Opening, Automatic door opening, Automatisk luck- öppning, Automatisk lugeåbning, Auto døråpning, Automaattinen luukun avaus, Ouverture auto porte, Automatische Lukenö- ffnung, Apertura autom.spor- tello, Apertura auto de puerta, Авто-открытие дверцы, Aut. deuropening			
			On, On, On, På, Til, På, Påällä, On, An, On, encendido, Вкл ., Aan	When then setting has been activated, the door will open automatically after the end of the program. Does not apply if Nodrain is selected (as there is still water in the machine).
			Off, Off, Off, Av, Fra, Av, Poissa, Off, Aus, Off, apagado, Выкл., Uit	Setting deactivated.
				Saves the setting and returns to the program menu, Program 15.







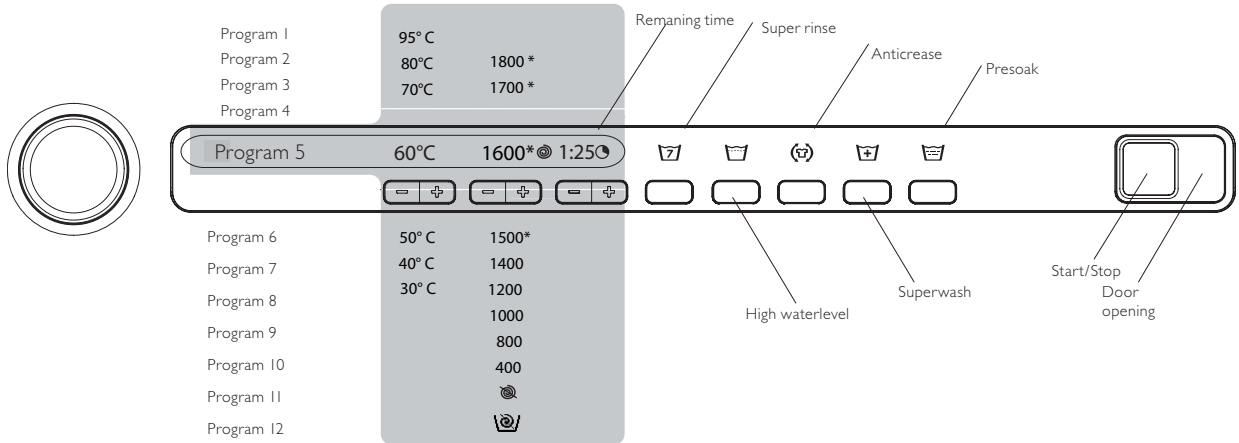



Making settings WM60.3 continuation

 	Language, Language, Language, Språk, Sprog, Språk, Kieli, Langue, Sprache, Lingua, Idioma, Язык, Taal			
			US English	
			English	Default
			Svenska	
			Dansk	
			Norsk	
			Suomi	
			Français	
			Deutsch	
			Italiano	
			español	
			Русский	
			nederlands	
			Saves the setting and returns to the program menu, Program 15	
	Temperature , F° or C° Setting, Temperature , Temperatur, Temperatur enhed, Temperaturrenhet, Lämpötilayksikkö, Unités de température, Temperaturreinheit, Unità temperatura, Unidad de temperatura, Шкала температур, Temperatuurweergave			
			°C	Celsius
				°F
				Saves the setting and returns to the program menu, Program 15
		Return, Return, Return, Tillbaka, Tilbage, Tilbake, Takaisin, Retour, Zurück, Uscire, Salir, Назад, Terug		You will return to the program menu, program 15





Selecting program WM60.2



Selecting options WM60.2

Press-/+	Comments/instructions
95°C	 Temperature Selection of temperatures between Cold and 95°C. Cold is the same as the incoming water temperature. For program 8 and 9, the maximum temperature is 40°C, for program 10, the maximum temperature is 60°C
80°C	
70°C	
60°C	
50°C	
40°C	
30°C	
-°C	
	 Spin Option of choosing spin speed between 400 and 1800 rpm. Spinning at 400 – 800 rpm signifies a short spin. Program 8 and 9 cannot be selected at speeds greater than 800 rpm.
1800 	
1700 	
1600 	
1500 	
1400 	
1200 	
1000 	
800 	
400 	
0	"No spin" means that the program does not include a spin cycle and ends by draining.
No d	"No draining" means that the program does not include a spin cycle and ends with the water from the final rinse still in the machine.
I-24 h	Delayed start

Selecting options WM60.2

Press -/+		Comments/instructions
Press 	The maximum number of rinses is seven and varies depending on selected program. Can be used with all programs except Auto, Time, Rinse, Spin or Drain programs.	Superrinse
Press 	Additional water is used during the main wash and rinse cycles. The machine takes in the additional water for the high water level about 15 minutes after the main wash has started.	High waterlevel
Press 	The drum rotate for three seconds /minute for two hours. Can be used with alla programs except Auto, Time, Wool/hand, No spin and Rinse.	Easy care
Press 	Increases the time during which water is pumped into the machine. Can be used with alla programs except Time, Quick, Wool/hand and Rinse.	Superwash
Press 	The laundry lies for two hours in cold water. Can be used in all programs except Auto, Time and Rinse.	Presoak



Making settings WM60.2

		Comments/instructions
	<ul style="list-style-type: none"> • Turn off the machine using the main power switch. • Press and hold the + on the Time button and the Super Rinse button, turn on the Main power switch. • Turn the program selector choose "Child-safe start off" or Child-safe start on" • Press Start/Stop button to store. Deactivate Child-safe start by pressing Super Rinse and Start/Stop at the same time. The option will be temporarily deactivated for three minutes.	Child safety
	<ul style="list-style-type: none"> • Turn off the machine using the main power switch. • Press Main power switch and Super rinse button. • "Door open is shown" on the disply. • Press Start/Stop button to store. 	Automatic door opening
	<ul style="list-style-type: none"> • Turn off the machine using the main power switch. • Press Main power switch and Start/Stop button • Turn the program selector and choose language. • Press Start/Stop button to store. 	Language

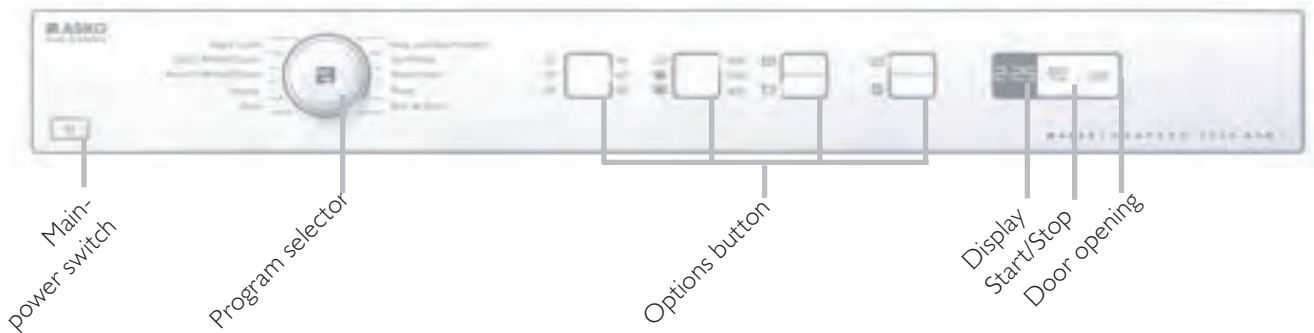









Selecting program WM60.I





Turn/ Press	Program	Description
	1. Auto	This program automatically adjusts the length of the main wash and the number of rinses to the amount of laundry loaded in the machine.
	2. Heavy	Program for heavily soiled laundry, with dirt that needs to be fully dissolved before the main wash. A pre-wash is used to do this. You can select the temperature freely, so follow the washing instructions for each garment. The highest temperature, 95°C, is suitable for very heavily soiled laundry. The spin speed can be selected freely. The machine adapts the program time and water consumption to the load size.
	3. Normal White/Colour	Program for normal to heavily soiled laundry, whites and colours. You can select the temperature freely, so follow the washing instructions for each garment. 60°C is a good temperature for heavily soiled cotton garments, as well as for garments worn next to the skin. Select 40°C if the laundry is less soiled. The spin speed can be selected freely. The machine adapts the program time and water consumption to the load size.
	4. Quick White/Colour	Program for normal to heavily soiled laundry, whites and colours. You can select the temperature freely, so follow the washing instructions for each garment. 60°C is a good temperature for heavily soiled cotton garments, as well as for garments worn next to the skin. Select 40°C if the laundry is less soiled. The spin speed can be selected freely. The machine adapts the program time and water consumption to the load size.
	5. Quick	Fast program for laundry that just needs freshening up. The program can be run at any temperature, so follow the washing instructions for each garment. The lower the selected temperature, the shorter the program time. Garments worn next to the skin ought to be washed at 60°C. The spin speed can be selected freely.
	6. Easy care/sportswear	Program for blended materials, permanent press shirts and functional sports clothing. The program has a high water level and as such is also suitable for cushions, quilted jackets and the like. Read the washing instructions carefully and remember, for example, that fabric softener must not be used with the membranes found in some outer garments. A washing temperature up to 60°C and a spin speed up to 1200 rpm can be selected.
	7. Synthetics	Program for delicate fabrics made of synthetic fibres, blended materials or silk. The maximum temperature is 60°C, but follow the washing instructions for each garment. Many synthetics will come clean at 40°C. Garments worn next to the skin ought to be washed at 60°C. The maximum spin speed is 800 rpm.

Turn/ Press	Program	Description
	8. Wool/Hand	A gentle laundry program for wool, silk and garments that should be washed by hand. The highest available temperature is 40°C. This program has a short spin. The maximum spin speed is 800 rpm.
	9. Rinse program	This program performs one cold rinse cycle + spin. Suitable for laundry that just needs to be dampened and for cleaning cloths and mops
	10. Spin/Drain	Used to just spin the wash. If you only want to drain the machine of water, select the  symbol (no spin)
	Press the start/Stop-button to start the program	



Selecting options WM60. I

Press	Description
	<p>Select the temperature by pressing the button until the LED by the desired temperature lights. You can select temperatures between 20°C and 95°C. For Wool/Hand you cannot choose a temperature higher than 40°C, when choosing Synthetics or Easy care the maximum temperature is 60°C.</p>
	<ul style="list-style-type: none"> Select the spin speed by pressing the button until the LED by the desired speed lights. You can select speeds between 400 and 1600 rpm, No spin or No drain. A spin with a speed of 400-800 rpm is always a short spin. You cannot choose a spin speed higher than 800 rpm for Wool/Hand and Synthetics No spin () means that the program does not include a spin cycle and ends by draining. No draining () means that the program does not include a spin cycle and ends with the water from the final rinse still in the machine. The washing will remain covered by the water from the final rinse and therefore will not become creased If you only want to drain the machine of water, select the Spin & drain program
	<ul style="list-style-type: none"> Select Super wash () by pressing the button by the symbol. An LED next to the button lights when this option is activated. Super wash can be selected to better dissolve difficult stains and heavy soiling on clothing. The main wash time in cold water is extended by approximately six minutes. The main wash time is also extended. This option cannot be selected with the auto, heavy, white and quick colours programmes. Select High water level () by pressing the button by the symbol. An LED next to the button lights when this option is activated. High water level means that additional water is used during the main wash and rinse cycles. This option can be used with all programmes except Wool/Hand, rinse and spin/drain. <p>Note! The machine takes in the additional water for the high water level about 15 minutes after the main wash has started.</p>
	<ul style="list-style-type: none"> Use the Super rinse () option if you want to increase the number of rinses. The maximum number of rinses is seven and varies depending on the selected programme. This option cannot be selected with rinse and spin/drain Select Super rinse by pressing the button by the symbol. An LED next to the button lights when this option is activated. Select Delayed Start () by pressing the Time button. You can delay the start by between 1 and 24 hours, the time is shown in whole hours. The LED next to the Time button shows that Delayed Start has been activated. <p>The machine counts down 1 hour at a time and starts after the selected delay.</p> <p>Note! Make sure the detergent compartment is completely dry before you add detergent, otherwise there is a risk that the detergent will clump before the machine starts.</p>
	Press the Start/Stop button to start program

Making settings WM60. I

Settings	Instructions
Automatic door opening	<ul style="list-style-type: none"> • Turn off the machine using the main power switch. • Press the Super rinse button  and then the main power switch. • "AdO" is shown on the display if automatic door opening is activated, or "AdF" if the option has not been activated. • Press the Super rinse button  to change the setting. • Press the Door opening button to save the setting.

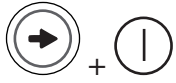
Service menu WM60.3



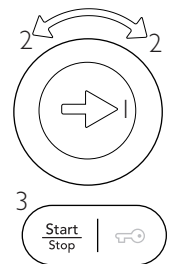

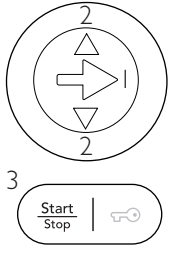





This is how to enter the service menu	
	If the machine is on: First switch the power off with the main power switch.
	Press the program selector (SI) at the same time as the Main power switch.
	Press the program selector button 3 times within 5 seconds. You are now in the service menu (shown in LCD 2. See instructions below for navigating the service menu.

Program selector	
	<ol style="list-style-type: none"> 1. Press the program selector button to scroll between the various service menus. 2. Turn the program selector button to make a selection between the menus (e.g. set a certain water inlet). Confirm the selection and go to the next menu by pressing the program selector button (I). 3. Press the Start/Stop button to confirm the settings and exit the service menu.

Program selector button for integrated machines	
	<ol style="list-style-type: none"> 1. Press the program selector button to scroll between the various options. 2. Press the small arrows to make a selection between the options (e.g. set a certain water inlet). Confirm the selection and go to the next option by pressing the program selector button (I). 3. Press the Start/Stop button to confirm the settings and exit the service menu.

Service menu WM60.3 continuation













The options below are displayed in the order they occur in LCD 2. All display text language versions are displayed.

Press/turn	LCD 2	Comments/instructions
 	DataSerialNo, Data Ser Num, Data-SerialNo, DataSerialNo, Serienummer; Serienummer; Dataversio Nro, N° de série, Seriennummer, Num. di serie, N° de serie, Серийный номер, Serienummer	Date for programming the software (Year_Week)
	CU date code, CU Date Code, CU date code, CU datum kod, CU dato kode, Styrekort prod dato, CU pvm koodi, Code date CU, CU Datumscode, Codice data CU, Código fecha CU, Код даты БУ, CU datacode	Control unit's date of manufacture (Year_Week)
	Software, Software, Software, Mjukvara, Software, Software ver., Ohjelmisto, Logiciel, Software, Software, Software, Версия прог., Software	Software version number.
	No. of cycles, Number of Cycles, No. of cycles, Antal cykler, Antal cyklusser, Antall bruk, Syklien lkm, Nb. de cycles, Anzahl der Zyklen, Numero cicli, N° de ciclos, Кол-во циклов, Aantal cycli	Number of cycles/programs run
	 Press  to exit the service menu	
 	"Error_Number of cycles" "Error_Number of cycles" "Error_Number of cycles"	Last three errors and number of cycles is shown. Total reset deletes the error indications from the system. Delete the error indications by pressing the DOOR OPENING BUTTON and the MAIN POWER SWITCH at the same time.
	Press  to exit the service menu	
	Testing	
	Test valve 1, Testing Valve 1, Test valve 1, Ventiltest 1, Tester ventil 1, Test av vannventil 1, Mg venttiilitesti 1, Essai vanne 1, Ventil testen 1, Test valvola 1, Test válvula 1, Тест клапана 1, Test inlaatventiel 1	Inlet valve 1 is open. Pressure sensor value is shown in LCD 2.
	Test valve 2, Testing Valve 2, Test valve 2, Ventiltest 2, Tester ventil 2, Test av vannventil 2, Mg venttiilitesti 2, Essai vanne 2, Ventil testen 2, Test valvola 2, Test válvula 2, Тест клапана 2, Test inlaatventiel 2	Inlet valve 2 is open. Pressure sensor value is shown in LCD 2.
	Test valve SM, Testing Valve SM, Test valve SM, Ventiltest SM, Tester ventil SM, Test av vannventil SM, Mg venttiilitesti SM, Essai vanne SM, Ventil testen SM, Test valvola SM, Test válvula SM, Тест клапана SM, Test inlaatventiel SM	Inlet valve 1 and 2 is open. Pressure sensor value is shown in LCD 2.
	Test heater, Testing Heater, Test heater, Elementtest, Tester varmelegeme, Test av element, Vastustesti, Essai résistance, Heizung testen, Test elem. riscald., Test elemento calef, Тест ТЭНа, Test verw.element	Heater is on until max 60 °C. Thermistor value is shown in LCD 2.

Service menu WM60.3 continuation

	Test motor, Testing Motor, Test motor, Motortest, Tester motor, Test av motor, Moottoritest, Essai moteur, Motor testen, Test motore, Test motor, Тест мотора, Test motor	The motor is running at normal action (49 rpm)
	Test drain, Testing Drain, Test drain, Tömningstest, Tester udpumpning, Test av tømning, Tyhjennyspumppute- sti, Essai vidange, Abfluss testen, Test scarico, Test drenaje, Тест насоса, Test afvoerpomp	Drain pump is on. Pressure sensor value is shown in LCD 2
	Test spin, Testing Spin, Test spin, Centrifugeringstest, Tester centrifugering, Test av sentrifugering, Linkouste- sti, Essai essorage, Schleudern testen, Test centrifuga, Test centrifugado, Тест отжима, Test centrifugeren	A Spin sequence is performed, the drain pump is running. Unbalance value is shown in LCD 2.
	Test door, Testing Door, Test door, Dörrtest, Tester luge, Test av dørlås, Luukun lukon testi, Essai porte, Luke testen, Test sportello, Test puerta, Тест замка дверцы, Test deurslot	Door lock is activated, the door is then opened.
	Press to exit the service menu	
 	0	Setting amount of water taken into the machine. Default value is "0".
	-15%	
	-10%	
	-5%	
	+5%	
	+10%	
	+15%	
	Press to exit the service menu	
 	0	Adjust LCD contrast. Default value is "0".
	+3	
	+2	
	+1	
	-1	
	-2	
	-3	
	Press to exit the service menu	
 	Rinses3, Rinses3, Rinses3, Sköljning3, Skyllning3, Skylling3, Huuhtelut3, Rinçage3, Spült3, Risciacqui3, Enjua- gues3, o o a e3, Spoelen3	Adjusting the default setting for rinsing (default = 5 rinses). Setting can be made in heavy (Program 2), White (3) colour (Program 4)
	Rinses5, Rinses5, Rinses5, Sköljning5, Skyllning5, Skylling5, Huuhtelut5, Rinçage5, Spült5, Risciacqui5, Enjua- gues5, o o a e5, Spoelen5	
	Press to exit the service menu	

Service menu WM60.3 continuation



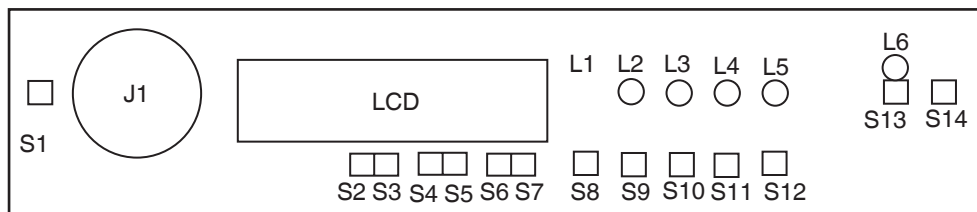

	<p>Reheat Off, Reheat Off, Reheat Off, Återvärmning Av, Genopvarmning Fra, Oppvarming Av, Uudelleenlämmitys Poissa, Réchauffage Off, Erneut heizen Aus, Riscaldamento Off, Recalentamiento apagado, Нагрев Вык., Opnieuw verwarmen Uit</p>	<p>Deactivate the function.</p>						
	<p>Reheat On, Reheat On, Reheat On, Återvärmning på, Genopvarmning Til, Oppvarming På, Uudelleenlämmitys Päällä, Réchauffage On, Erneut heizen An, Riscaldamento On, Recalentamiento encendido, Нагрев Вкл., Opnieuw verwarmen Aan</p>	<p>Activate the function</p>						
								
	<table border="1"> <tr><td>1500 rpm</td></tr> <tr><td>1600 rpm</td></tr> <tr><td>1700 rpm</td></tr> <tr><td>1800 rpm</td></tr> <tr><td>1900 rpm</td></tr> <tr><td>2000 rpm</td></tr> </table>	1500 rpm	1600 rpm	1700 rpm	1800 rpm	1900 rpm	2000 rpm	<p>Setting maximum speed. Maximum rpm is either 1800 or 2000 rpm depending on model.</p>
1500 rpm								
1600 rpm								
1700 rpm								
1800 rpm								
1900 rpm								
2000 rpm								
	<p>Press   to exit the service menu</p>							
<p>Reset</p>								
	<p>Language</p>	<p>US English, English, Svenska, Dansk, Norsk, Suomi, Francais, Deutsch, Italiano, Esoanol, Русский, Nederlands</p>						
	<p>Clock</p>	<p>24hr Realtime, 24 Hour Clock, 24hr Realtime, 24 timmarsvisning, 24 timers ur, 24t realtid, 24 h aika, Horloge 24 h, 24 Std. Echtzeit, 24h Tempo reale, Reloj 24 horas, Формат времени 24-ч., 24 uur weergave</p> <p>12hr Realtime, 12 Hour Clock, 12hr Realtime, 12 timmarsvisning, 12 timers ur, 12t realtid, 12 h aika, Horloge 12 h, 12 Std. Echtzeit, 12h Tempo reale, Reloj 12 horas, Формат времени 12-ч., 12 uur weergave</p> <p>No Real time, No Real Time, No Real time, Ej realtid, Intet ur, Ingen realtid, Ei aikaa, Pas d'horloge, Keine Echtzeit, No tempo reale, Sin hora real, Время не установлено, Geen tijdsweergave</p>						
	<p>Transport protection</p>	<p>Transport protection, Transport protection, Transportskydd, Transportbeskytt., Transportvern, Kuljetustuet, Protection transport, Transportsicherung, Protezione trasporto, Anclaje transport, защита при транспортировке, Transportbescherming</p>						
<p>Press   to exit the service menu</p>								















Service menu WM60.2







ⓘ	Switch off, and then on main power.
S6	<ul style="list-style-type: none"> •Wait for at least 5 seconds •Press down button S6 •Turn on the power •Pressing S6 when power on followed by 3 pushes on S6 within 5 sec enters the service menu.
NOTE!	Make all selections. Pressing S13 stores all selections made in service menu and leaves service mode.
Turn J1	<p>Tracking data read out</p> <p>SP: (software programming date: year week CM: (control unit manufacturing date: year week SV: (Software version) SV: (Software version) NC: Number of cycles Press S14 next step is accessed.</p>
	<p>Failure read out</p> <p>Rotating J1 will display 2nd and 3rd last deviating fault, ex "Thermistor fault (2); 30", "Over flow (3); 20" Failure record is cleared by total reset Pressing S14 next step is accessed.</p>
	<p>Diagnostics</p> <p>Separate test of auxiliary components. Rotating J1 each component will be turned on (with a 1 sec delay) and inputs detected in sequence: "Testing" (no component), "Testing valve 1" (inlet valve 1 on), "Testing valve 2" (inlet valve 2 on), "Testing valve SM" (inlet valve 1 and 2 on), "Testing heater" (heater on until max 60°C), "Testing motor" (normal action), "Testing drain" (drain pump on), "Testing spin" (spin sequence, drain pump on), "Testing door". Pressing S14 components will be off and next step is accessed.</p>
	<p>Rinse setting</p> <p>Turn J1 counter clockwise "3 rinses" default or clockwise " 5 rinses" Pressing S14 next step is accessed.</p>
	<p>Temperature °C/°F</p> <p>Turn J1 counter clockwise "°C" default or clockwise " °F" Pressing S14 next step is accessed.</p>
	<p>Spin speed</p> <p>Turn J1 counter clockwise 1500 rpm, 1600 rpm, 1700 rpm, 1800 rpm, default or clockwise 1800 rpm, 1700 rpm ... Pressing S14 next step is accessed or S13 to store or leave service mode.</p>
	<p>Total reset</p> <p>By pressing S14 when power on the software total resets (return to default values of all settings). Service menu settings and parameters only re-programmable in in-line programming excluded (shall not reset).</p>







Service menu WM60.I

How to get to the service menu	
	Is the machine turned on: turn off the power first at the main switch
 + 	Press and hold the Start/Stop button while you press the main switch
 X 5	Press the Start/Stop button five times.

Turn/press	SCREENING	Comments/Instructions
		No component
		Intake valve 1 starting
		Intake valve 2 starting
		Intake valve 1 and 2 starting
		Heater starts and warms up to a maximum of 60 ° C
		Drain pump starts
		Spin and drain pump starts
		Door opening
	Press the button for Super Wash (S7) to get to the settings of the number of rinse.	
		5 rinses
		3 rinses
	Press the START / STOP button (S10) to store the choices and leave the service menu. Press the button for Super Wash (S7) to get back to the component test.	

Shop program WM60.3

1. Activating the Shop program (for machines manufactured up to week 736)	
 + 	<p>If the machine is on: First turn off the power at the main power switch. Then press and hold the Start button while turning on the main power switch. At this point no settings can be made. The centre display will activate after 3 minutes. Settings can now be made, but the machine cannot be started.</p>
2. Stopping the Shop program (for machines manufactured up to week 736)	
 + 	<p>First turn off the power at the main power switch. Then press and hold the Start button while turning on the main power switch. The Shop program is now stopped.</p>

1. Activating the Shop program (for machines manufactured from week 737 on)	
 +   x5	<p>If the machine is on: First turn off the power at the main power switch. Then press and hold the Start button while turning on the main power switch. Press the program selector 5 times At this point no settings can be made. The centre display will activate after 3 minutes. Settings can now be made, but the machine cannot be started.</p>
2. Stopping the Shop program (for machines manufactured from week 737 on)	
 +   x5	<p>First turn off the power at the main power switch. Then press and hold the Start button while turning on the main power switch. Press the program selector 5 times. The Shop program is now stopped.</p>

Store program WM60.2 and WM60.1

There are no store programs on the WM60.2 and WM60.1.

Fault indications WM60.3

The below faults are indicated in plaintext in LCD I. The table shows the indication in all languages and language variations.

LCD I	Cause	Action
Over flow fault, Overflow Fault, Over flow fault, Överflyllnad, Overløbsfejl, Overflom, Ylitulviminen, Trop plein, Überfüllt, Troppo pieno, Desborde, Перелив воды, Te veel water	Too much water in the machine	Service action: Check the machine's level system, inlet valve and drain pump. Make sure that there is no leaks.
	The drain pump is on, without any water in the machine.	Service action: The overflow protection at the bottom of the machine is activated (not all models). Make sure that there is no leaks (water on the machines base)
Water outlet fault, Water Outlet Fault, Water outlet fault, Uttömningsfel, Udpumpningsfejl, Vannutløp, Vedenpoistovika, Défaut , Wasserablauffehler, Uscita acqua, Fallo, Слив воды, Waterafvoer fout	1. The drain pump has been activated more than 3 minutes. There is still water in the machine. 2. The wash cycle is interrupted and the program is cleared	Customer information: 1. Check that no objects are stuck in the drainage hose outlet. 2. Check that the drain pump is not blocked by foreign objects. 3. Check that there are no kinks in the drainage hose. Service action: 1. If the pump only runs for a short while (approximately 20 seconds), this indicates a fault in the level system. Check the level sensor and hoses. 2. Check wiring and voltage to the pump. If necessary, replace the pump and/or control 3. After implementing corrective action, run the Drain program or press the Key button
Water inlet fault, Water Inlet Fault, Water inlet fault, Vattenintagsfel, Vandintagsfejl, Vanntilførsel, Vika vedenotossa, Défaut, Wasseraufn.-fehler, Entrata acqua , Fallo , Набор воды, Watertoevoer fout	If the correct water level is not reached within 5 minutes, the wash cycle is interrupted.	Customer information: 1. Check that the tap on the water pipe is open. Service action: 1. Check that the filter in the machine's water intake is not blocked. 2. Check the inlet valve. If necessary, replace the valve. 3. Check voltage to the inlet valve. If there is no voltage, this could be due to a fault in the level system, wiring or control unit.
Security fault, Security Sys Fault, Security fault, Lucköppningsfel, Sikkerhedsfejl, Sikkerhetsfeil, Vika turvajärj., Erreur sécurité, Sicherh.-fehler, Err: sis.sicurezza, Fallo sistema seguridad, Ошибка сис. безоп., Deurslot fout	The door is open.	Close the door
Thermistor fault, Thermistor Fault, Thermistor fault, Termistorfel, Termostat fejl, Termistor, Termistorivika, Défaut , Termistorfehler, Termistore , Fallo , Термистор, Temp. sensor fout	1. The circuit for the thermistor is open. 2. The thermistor is faulty 3. The measurement value for the thermistor is <300 Ω (>120 °C)	Service action: Check the thermistors function. If needed, replace it.
Temperature fault, Temperature Fault , Temperature fault, Temperaturstoppfel, Temperatur fejl, Temperaturstopp, Ei lämmitä vettä, Défaut , Temp.-stoppfehler, Errore arresto , Fallo , Температура, Temperatuurstop	• The temperature is raised < 5 °C/41°F within 10 minutes. The wash cycle continues to next step	Service action: Check the heater, cables, thermistor and level system.
Wash motor fault, Wash Motor Fault , Wash motor fault, Motorfel, Motor fejl, Motorfeil, Moottorivika, Défaut , Motorfehler, Motore lavaggio , Fallo , Мотор, Motorstoring	No signal from Tacho or MCU..	Service action: Check signal from the MCU and cables between motor and MCU.
Pressure fault, Pres Sensor Fault, Pressure fault, Tryksensorfel, Tryksensor fejl, Nivåfeil, Painesensorivika, Défaut , Drucksensorfehler, Pressostato , Fallo , Датчик уровня, Druksensor fout	Indicated if the level drops to 0 within 30 seconds of the first rinsing.	Service action: Check the leakage

After carrying out corrective actions as above, reset the fault indications by pressing the DOOR OPERING BUTTON at the same time as the main power switch.

Fault indications WM60.2

Error messages	Cause	Action
Over flow fault	Too much water in the machine	Service action: Check the machine's level system, inlet valve and drain pump. Make sure that there is no leaks.
	The drain pump is on, without any water in the machine.	Service action: The overflow protection at the bottom of the machine is activated (not all models). Make sure that there is no leaks (water on the machines base)
Water outlet fault	<ol style="list-style-type: none"> 1. The drain pump has been activated more than 3 minutes. There is still water in the machine. 2. The wash cycle is interrupted and the program is cleared 	<p>Customer information:</p> <ol style="list-style-type: none"> 1. Check that no objects are stuck in the drainage hose outlet. 2. Check that the drain pump is not blocked by foreign objects. 3. Check that there are no kinks in the drainage hose. <p>Service action:</p> <ol style="list-style-type: none"> 1. If the pump only runs for a short while (approximately 20 seconds), this indicates a fault in the level system. Check the level sensor and hoses. 2. Check wiring and voltage to the pump. If necessary, replace the pump and/or control 3. After implementing corrective action, run the Drain program or press the Key button (door open) to empty the machine.
Water inlet fault	If the correct water level is not reached within 5 minutes, the wash cycle is interrupted.	<p>Customer information:</p> <ol style="list-style-type: none"> 1. Check that the tap on the water pipe is open. <p>Service action:</p> <ol style="list-style-type: none"> 1. Check that the filter in the machine's water intake is not blocked. 2. Check the inlet valve. If necessary, replace the valve. 3. Check voltage to the inlet valve. If there is no voltage, this could be due to a fault in the level system, wiring or control unit.
Security fault	The door is open.	Close the door
Thermistor fault	<ol style="list-style-type: none"> 1. The circuit for the thermistor is open. 2. The thermistor is faulty 3. The measurement value for the thermistor is $<300 \Omega$ ($>120 \text{ }^\circ\text{C}$) 	Service action: Check the thermistors function. If needed, replace it.
Temperature fault	The temperature is raised $< 5 \text{ }^\circ\text{C}/41^\circ\text{F}$ within 10 minutes. The wash cycle continues to next step	Service action: Check the heater, cables, thermistor and level system.
Engine fault	No signal from Tacho or MCU.	Service action: Check the output from the MCU and the wiring between the motor and the MCU
Pressour sensor fault	Indicated if the level drops to 0 within 30 seconds of the first rinsing.	Service action: Check the leakage

After carrying out corrective actions as above, reset the fault indications by pressing the DOOR OPERING BUTTON at the same time as the main power switch.

Fault indicators WM60.I

Error messages on the display	Cause	Action
FI0 – Overflow	Too much water in the machine.	Service action: - Check the machine's level system, inlet valve and drainage pump. - Check for any leaks.
	The drainage pump is running but the machine is empty.	Service action: - The overflow cut-out at the bottom of the machine has been activated (some models only). - Check for leaks.
FI1 - Water outlet fault	The drainage pump has been running for 3 minutes. Water remains in the machine. The wash cycle has been interrupted and the programme reset.	Information to customer: - Check that no objects are stuck in the drainage hose outlet. - Check that the drainage pump is not blocked by foreign objects. - Check that there are no kinks in the drainage hose. Service action: - If the pump only runs for a short while (approximately 20 seconds), this indicates a fault in the level system. Check the level sensor and hoses. - Check wiring and voltage to the pump. If necessary, replace the pump and/or control unit. After implementing corrective action, run the Drain programme or press the Key (door opening) button to empty the machine.
FI2 – Water inlet fault	If the correct water level is not achieved within 5 minutes the wash cycle will be interrupted.	Information to customer: - Check that the tap on the water pipe is open. Service action: - Check that the filter in the machine's water intake is not blocked. - Check the inlet valve. If necessary, replace the valve. - Check voltage to the inlet valve. If there is no voltage, this could be due to a fault in the level system, wiring or control unit.

Components and measurement values WM60

Item number	Component	Measurement value	Comments
80 658 33	CIM-motor	Resistanser: Pin 1-3 stator 3,7 Ω Pin 1-2 stator 3,6 Ω Pin 2-3 rotor 3,6 Ω Pin 4-5 tachometer 178 Ω	
80 617 06	Heating element 2000 W	28,4 Ω	
80 014 74	Thermistor compl. with holder	6.1-3.8 k Ω (at room temperature 20 – 30°C/ 86°F)	The thermistor for temperature reading is located between the motor cradle and the container. The thermistor measures and controls the water temperature that can vary from 0 to 90°C/ 194°F. The element is disconnected if the thermistor is short-circuited or disconnected from the program control card.
88 012 63.	Drain pump 50 Hz	144 Ω .	The drain pump is combined with an integrated fine filter trap, which can be cleaned by the user. If the drain pump has run for 180 seconds during draining, the program stops, resets and a fault code is indicated in the display. The drain pumps capacity is 20 liters/min.
88 012 64.	Drain pump 60 Hz	76 Ω	
80 762 02	EMC filter with inductor 50/60 Hz	680 k Ω	The filter eliminates interference to and from the machine.
80 838 80	Inlet valve	3,7 k Ω \pm 0,5 k Ω	2 way inlet valve 8 litres / minute
80 798 73	Door lock	122 Ω	The door lock is electro mechanical and equipped with a magnet.
80 822 54	Control Unit WM60.3		
80 822 55	Control Unit WM60.3 FI		
80 822 58	Frequency converter w. holder WM60.3, WM60.I		
80 014 68	Control unit WM60.2		

Components and measurement values

Temp, ° C	Resistance, Ohm
0	15806
10	9634
20	6046
25	4841
30	3900
40	2579
50	1744
60	1204
70	848
80	609
85	519

Technical data WM60

Height:	850 mm
Width:	595 mm
Depth:	585 mm
Weight:	73 kg / 78 kg (with outer door)
Cylinder volume:	50 l
Max. washing capacity	EU 7,0 kg, AU, US 6,0kg SE 5.0 kg
Spin speed:	WM60.3 400–2000 rpm, WM60.2 400–1800 rpm, WM60.1 400–1600 rpm
Connection:	1 fas 10 A
Element power:	2000W, 230V (See type designation)
Water pressure/Inlet valve:	0,1 – 1 MPa., 1 – 10 kp/cm ² , 10 – 100 N/cm ² . 8 liter/min
Wash drum and liquid compartment material:	Stainless steel
Outer casing material:	Powder-coated and hot-galvanized sheet steel or stainless steel
Set-up:	Stationary on four adjustable, rubber-clad feet
Water connection:	1,5 m pex tubing, 3/4" – 3/4" eller 3/4" – 1/2"
Drain:	1.7 m polypropylene tubing
Protection class:	IP X4
Water consumption (tested normal program)	59 l (3 rinses), <72 l (5 rinses)
Energy consumption (tested normal program)	1,02kWh, WM60.1 0,95 kWh
Electricity consumption, Standby:	
- Main power switch off	0.0 W
- Display on	5.0 W
- Display off	3.0 W

Tools

Torx; T25, T20, T10
Socket screwdriver 10 mm
5mm socket head cap screwdriver + small locking handle
Ring spanners; 11/16", 16mm, 13 mm, 10 mm
24mm extended socket + locking handle
Plastic hammer
Star socket head screwdriver
A pair of nippers

Wiring diagram WM60.3

RESISTANCES AT ROOM TEMPERATURE (CA. 20°C/68°F)
VALUES WITH +/-10% ARE REGARDED AS NORMAL COMPONENT

F: RADIO INTERFERENCE SUPPRESSION FILTER 680K Ohm
 EL: HEATING ELEMENT 25 Ohm
 AP: DRAIN PUMP 50 Hz 144 Ohm
 AP: DRAIN PUMP 60 Hz 76 Ohm
 LL: DOOR LOCK 122 Ohm
 NTC: THERMISTOR 6.1 - 3.8 K Ohm
 IV 1: INLET VALVE 1 3.7 K Ohm
 IV 2: INLET VALVE 2 3.7 K Ohm
 MO: MOTOR, 1-3 3.7±7% Ohm
 1-2 3.6±7% Ohm
 2-3 3.6±7% Ohm

WIRES IN ALL MACHINES
 --- INTERNAL CONNECTION
 - - - WIRES IN SOME MACHINES
 *A FUSE CONNECTION USA & CANADA

CABLE POSITIONS
 1: MOTOR COMMUNICATION
 2: THERMISTOR
 3: INLET VALVES
 4: DOOR LOCK, DRAIN PUMP, PREASSURE SWITCH
 TB: POWER
 EL: HEATING ELEMENT, PREASSURE SWITCH
 MO: MOTOR POWER

MCU: MOTOR CONTROL UNIT
 TG: TACHO GENERATOR
 N: PRESSURE SWITCH
 TB: MAIN SWITCH
 FB: FLOAT SWITCH
 TS: PRESSURE SENSOR
 BA: CONTAINER
 INKB: INCOMING GROUND
 BO: BOTTOM

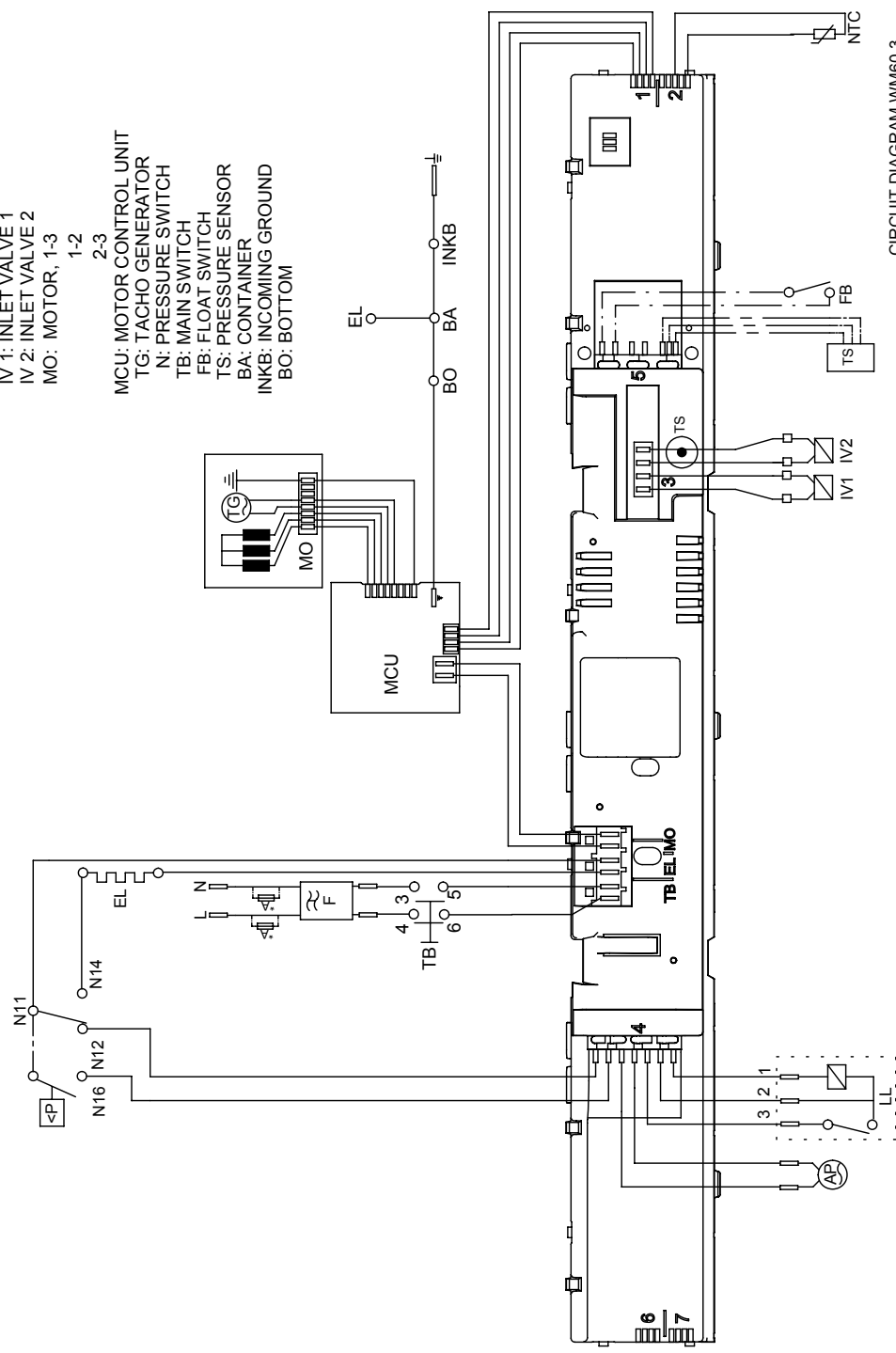

This document must not be copied, without our written permission, and the contents thereof must not be imparted to a third party without the express written permission. Contravention will be prosecuted.
 Askö Cyfina AB

CIRCUIT DIAGRAM WM60.3
80 788 69 - 03

Wiring diagram WM60.2

- RESISTANCES AT ROOM TEMPERATURE (CA. 20°C/68°F)
VALUES WITHIN +/-10% ARE REGARDED AS NORMAL COMPONENT
- F: RADIO INTERFERENCE SUPPRESSION FILTER 680K Ohm
 - EL: HEATING ELEMENT 25 Ohm
 - AP: DRAIN PUMP 50 Hz 144 Ohm
 - AP: DRAIN PUMP 60 Hz 76 Ohm
 - LL: DOOR LOCK, 1-2 122 Ohm
 - NTC: THERMISTOR 6.1 - 3.8 K Ohm
 - IV 1: INLET VALVE 1 3.7 K Ohm
 - IV 2: INLET VALVE 2 3.7 K Ohm
 - MO: MOTOR, 1-3 3.6±7% Ohm
 - 1-2 3.6±7% Ohm
 - 2-3 3.6±7% Ohm

- MCU: MOTOR CONTROL UNIT
- N: PRESSURE SWITCH
- TS: PRESSURE SENSOR
- TG: TACHO GENERATOR
- BA: CONTAINER
- INKB: INCOMING GROUND

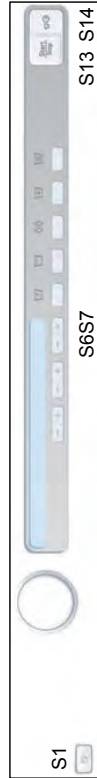

SERVICE MENU

- TURN OFF POWER (S1)
- WAIT FOR AT LEAST 5 SEC
- HOLD S6 OR S7
- TURN ON POWER (S1)
- PRESS S6 OR S7 3 TIMES TO ENTER SERVICE MENU
- PRESS DOOR OPENING (S14) TO CHANGE MENU STEP
- ROTATE DIAL TO CHANGE IN STEP
- PRESSING START/STOP (S13) STORES AND EXITS SERVICE MENU

- STEP 1: PRODUCT DATA
- STEP 2: FAILURE DATA
- STEP 3: COMPONENT TEST

TOTAL RESET

- TURN OFF POWER (S1)
- WAIT FOR AT LEAST 5 SEC
- HOLD DOOR OPENING (S14)
- TURN ON POWER (S1)

- CABLE POSITIONS**
- 1: MOTOR COMMUNICATION
 - 2: THERMISTOR
 - 3: INLET VALVES
 - 4: DOOR LOCK, DRAIN PUMP, PREASSURE SWITCH
 - 8: POWER
 - 9: HEATING ELEMENT, PREASSURE SWITCH
 - 10: MOTOR POWER
- *A FUSE CONNECTION USA & CANADA
 ——— WIRES IN ALL MACHINES
 - - - - INTERNAL CONNECTION

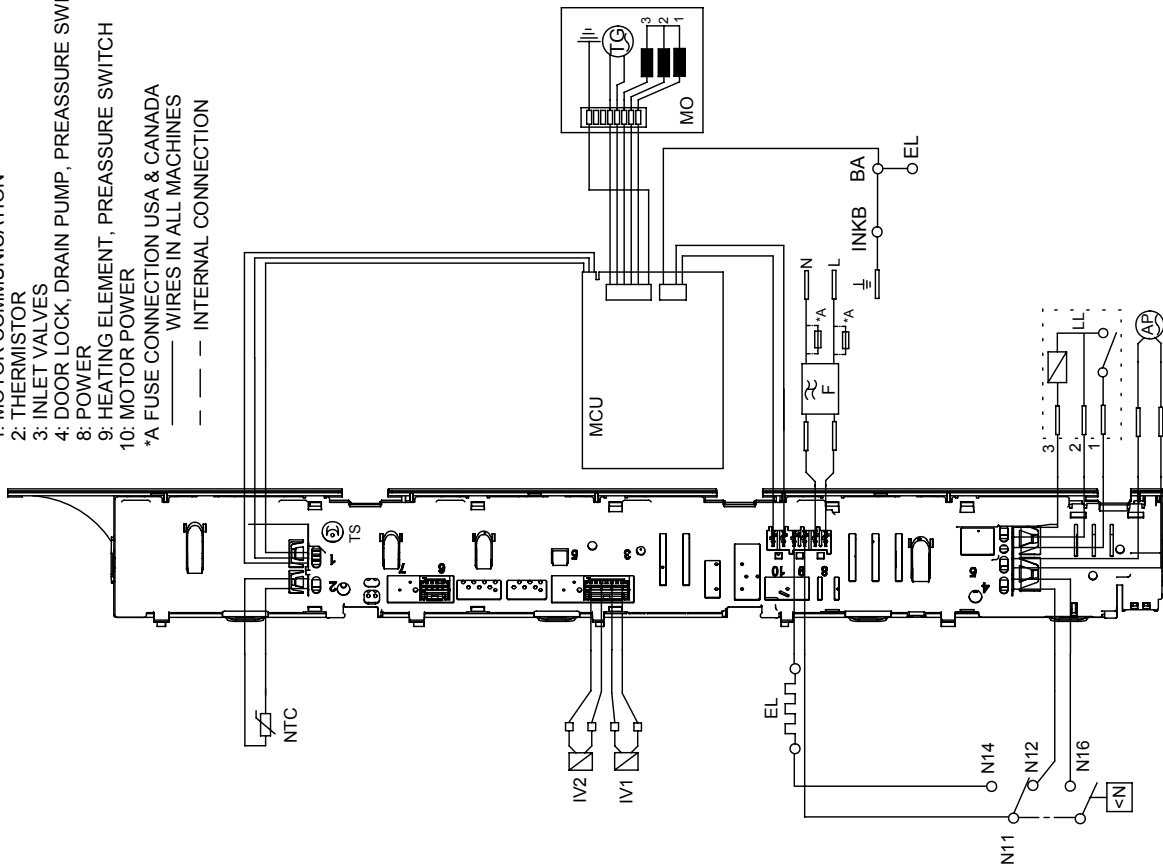

This document must not be copied without the permission of the copyright holder. The information contained herein may not be used for any unauthorized purpose. Askö Cylindrar AB

CIRCUIT DIAGRAM WM60.2

80 807 15 - 02

Circuit diagram WM60.1

RESISTANCES AT ROOM TEMPERATURE (CA. 20°C/68°F)
VALUES WITHIN +/-10% ARE REGARDED AS NORMAL COMPONENT

F: RADIO INTERFERENCE SUPPRESSION FILTER 680K Ohm
 EL: HEATING ELEMENT 25 Ohm
 AP: DRAIN PUMP 50 Hz 144 Ohm
 AP: DRAIN PUMP 60 Hz 76 Ohm
 LL: DOOR LOCK, 1-2 122 Ohm
 NTC: THERMISTOR 6.1 - 3.8 K Ohm
 IV 1: INLET VALVE 1 3.7 K Ohm
 IV 2: INLET VALVE 2 3.7 K Ohm
 MO: MOTOR, 1-3 3,6±7% Ohm
 1-2 3,6±7% Ohm
 2-3

MCU: MOTOR CONTROL UNIT
 N: PRESSURE SWITCH
 TS: PRESSURE SENSOR
 TG: TACHO GENERATOR
 BA: CONTAINER
 INKB: INCOMING GROUND



TOTAL RESET

TURN OFF POWER (S1)
 WAIT FOR AT LEAST 5 SEC
 HOLD DOOR OPENING (S11)
 TURN ON POWER (S1)

SERVICE MENU

TURN OFF POWER (S1)
 WAIT FOR AT LEAST 5 SEC
 HOLD START/STOP (S10)
 TURN ON POWER (S1)
 PRESS START/STOP (S10) 5 TIMES TO ENTER SERVICE MENU
 PRESS DOOR OPENING (S11) TO CHANGE MENU STEP
 ROTATE DIAL TO CHANGE IN STEP
 PRESSING START/STOP (S10) STORES AND EXITS SERVICE MENU

2009-09-03

CIRCUIT DIAGRAM WM60.1

80 820 35

This document must not be copied without our written permission, and the contents hereof may not be used for any unauthorized purpose. Contravention will be prosecuted. Askro Appliance AB

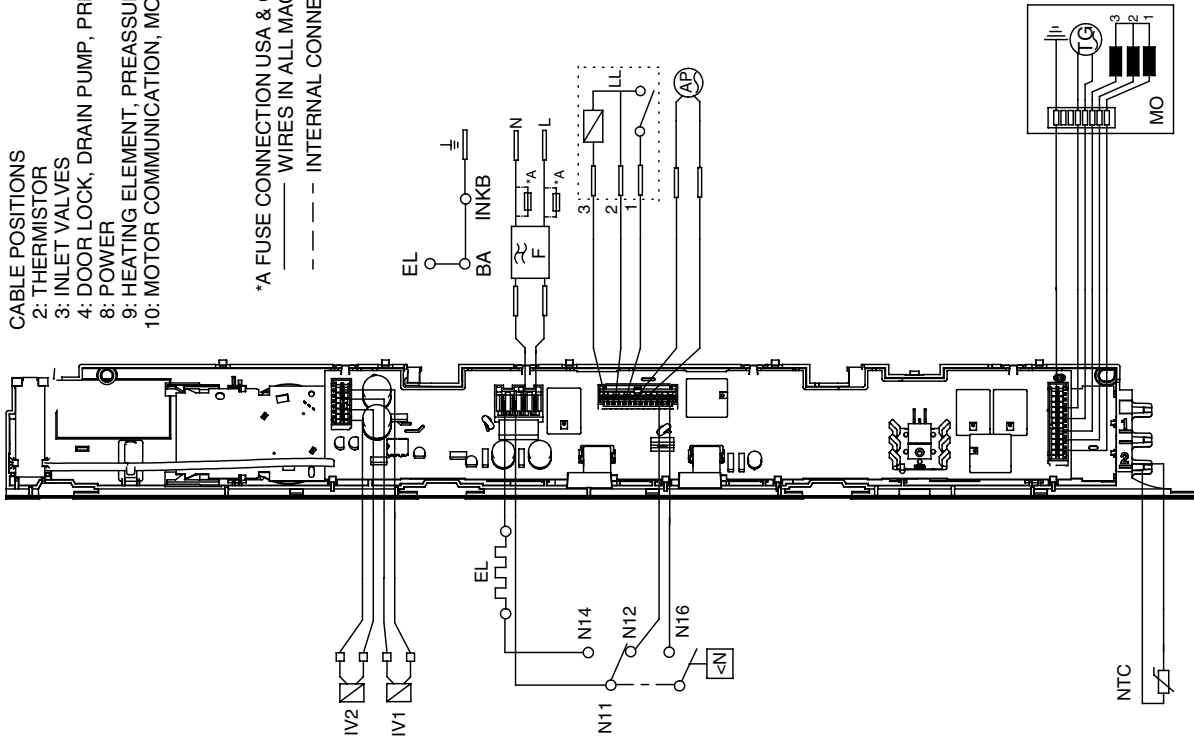

CABLE POSITIONS
 2: THERMISTOR
 3: INLET VALVES
 4: DOOR LOCK, DRAIN PUMP, PREASURE SWITCH
 8: POWER
 9: HEATING ELEMENT, PREASURE SWITCH
 10: MOTOR COMMUNICATION, MOTOR POWER

*A FUSE CONNECTION USA & CANADA
 ——— WIRES IN ALL MACHINES
 - - - - INTERNAL CONNECTION







Rehanging the door

Some machines in the WM60-series is supplied with a door - is that the case the door is hung on the left-hand side. It is, however, possible to re-hang it according to the instructions below. Take care not to damage the paint when carrying out work with tools.

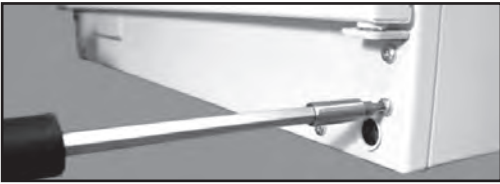
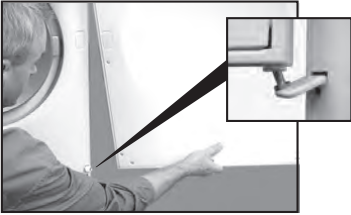
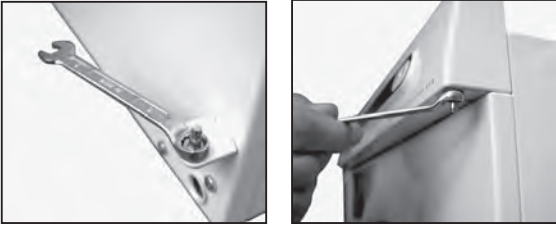
Required tools	
Flathead screwdriver	
Torx size 20	
Fixed spanner size	

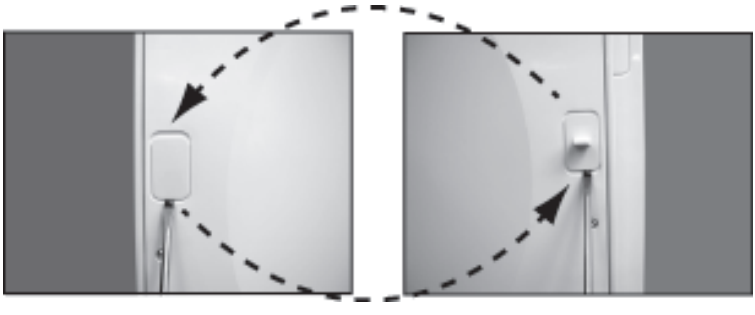
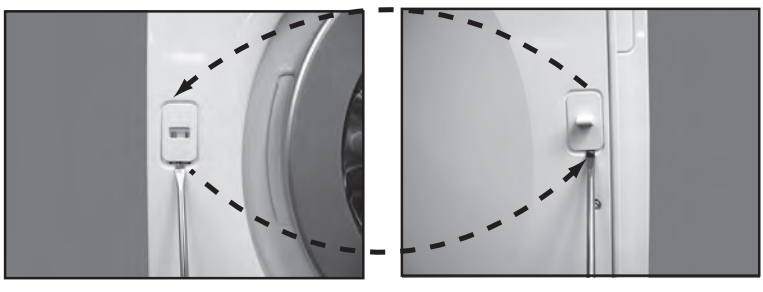
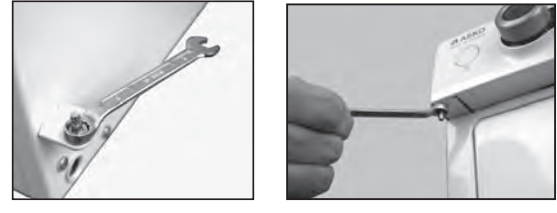

Instructions	Image
1. Remove the plinth by carefully pulling it out.	
2. Remove both screws for the lower hinge. Use Torx.	
3. Push the door upwards with care and angle outwards. If necessary, carefully press the lower hinge to detach the door.	
4. Slacken off the lower and upper hinge pins using a fixed spanner.	

<p>5. Remove the plastic plugs covering the holes for the hinge pins and switch location</p>	
<p>Method for removing plastic plugs, lock and catch located on the machine and the door: Carefully push the plug, catch or lock upwards with a flat screwdriver, as the picture shows.</p>	
<p>6. Carefully remove the catch and plastic plug on the door (according to the method above) and switch location.</p>	
<p>7. Carefully remove the lock and plastic plug on the machine (according to the method above) and switch location.</p>	
<p>8. Screw the hinge pins securely into place on the corresponding side of the machine.</p>	
<p>9. Slacken off the screws for the lower hinge on the corresponding side of the machine. This must be done to hang the door.</p>	

10. Align the door in the upper hinge. Carefully push the lower hinge down if necessary and align the door.



11. Screw the lower hinge into place securely. Use Torx.





12 Press the plinth into place. The door has now been re-hung.



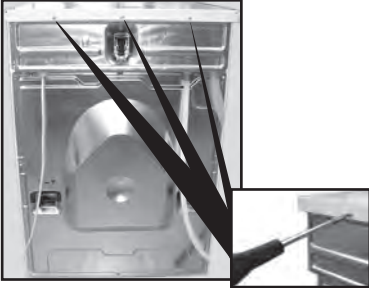
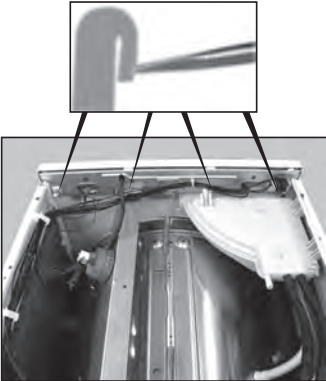
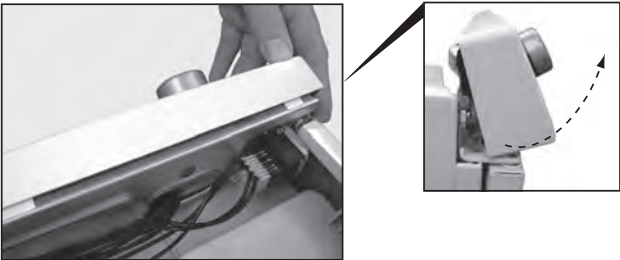
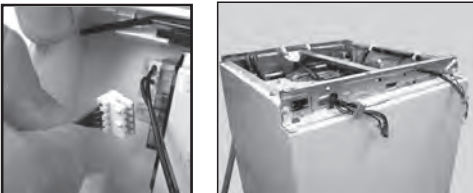
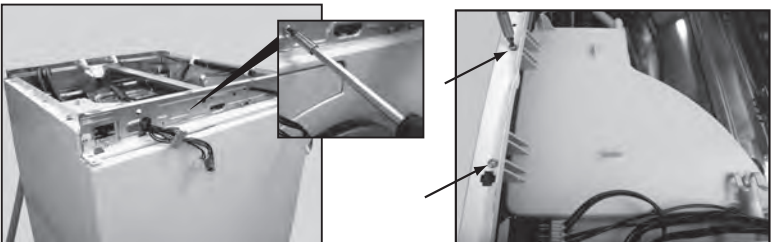

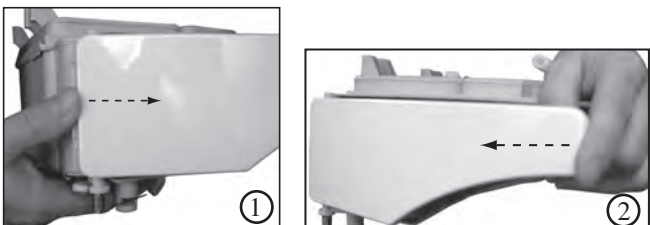
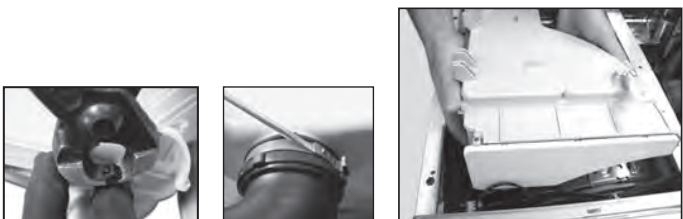
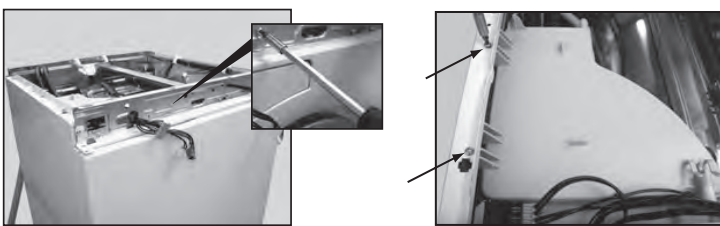
Replacing panels and detergent compartment

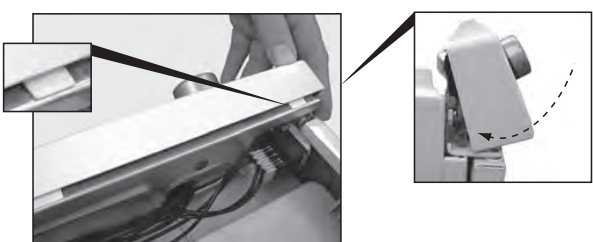
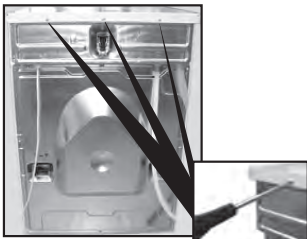

Instructions	Image
<p>1. Unscrew the top cover.</p>	
<p>2. Carefully press the catches that secure the panel at the front beam. Release the catches from the front member by working the panel outwards.</p>	
<p>3. Detach the panel by angling and pulling it carefully outwards at the lower edge.</p> <p>Note: Do not damage the wiring!</p>	
<p>4. Carefully disconnect the wiring from the control unit.</p>	
<p>5. When removing the detergent compartment, first slacken off the screw on the front member and then the two screws holding the detergent compartment in the side panel.</p>	

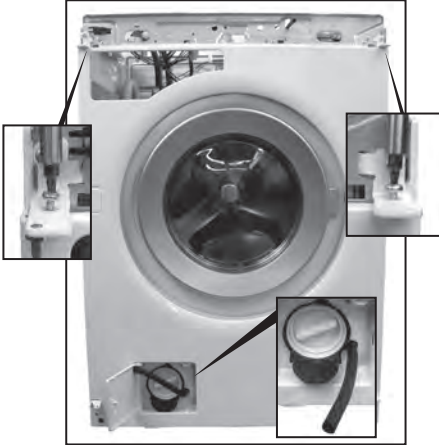
Instructions	Image
<p>6. Lift the detergent compartment. Then remove the hose clamps for all hoses, which are secured in the detergent container. Then detach the hoses from the detergent compartment.</p>	
<p>7. If necessary: Replace the decor panel for the detergent compartment. Detach the decor panel by pressing according to image 1. Install the decor panel by first placing the decor panel in the grooves on the detergent container and then snapping it into place as illustrated in image 2.</p>	
<p>8. Install the detergent compartment by first pressing all hoses into place and then securing them using the hose clamps.</p>	
<p>9. Screw the detergent compartment into place using the three screws (one in the front panel and two in the frame)</p>	
<p>10. Install all wiring in the relevant locations on the control card.</p>	
<p>11. Install the panel. Angle the panel outwards and place the mounting plates in the relevant grooves in the front frame. Angle the panel downwards and secure it with the catches</p>	
<p>12. Screw the top cover into place.</p>	

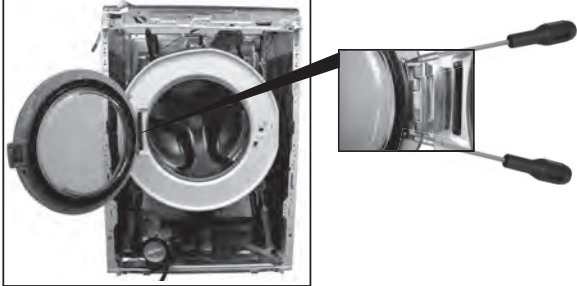
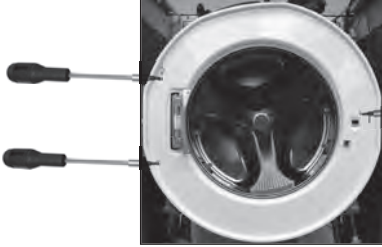
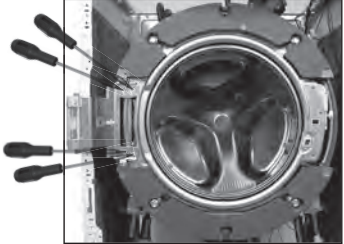
Replacing front panel, door, cover plate and the hinges

Instructions	Image
<p>1. Unscrew the screws in the hooks holding the front panel. Then carefully pull off the drainage hose that is secured in the door for the drainage pump.</p> <p>Note! Water is poring out when the drainage hose is pulled off.</p>	
<p>2. Unscrew the screws holding the front panel. Then remove the front panel by carefully pulling it out at the lower edge.</p>	
<p>3. Unscrew the two screws holding the glass door. Use Torx.</p>	
<p>4. Unscrew the three screws that hold the cover plate to the container. Use Torx.</p>	
<p>5. Unscrew the four screws securing the hinge to the container. Use Torx. After removing the four screws, remove the cover plate and hinge.</p>	

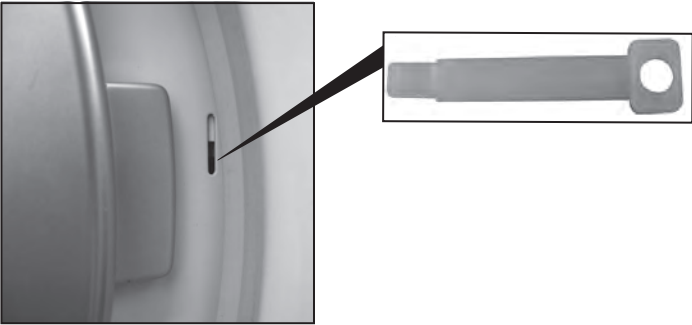
Emergency opener for door lock

Instructions	Image
<p>1. The emergency opener is in the documentation kit.</p>	
<p>3. Push the emergency opener into the slot beside the glass door.</p>	
<p>4. Push the emergency opener upwards, and the door will open.</p>	

Timer diagram WM60.3

Timer diagram Program 4
(Continue on next page)

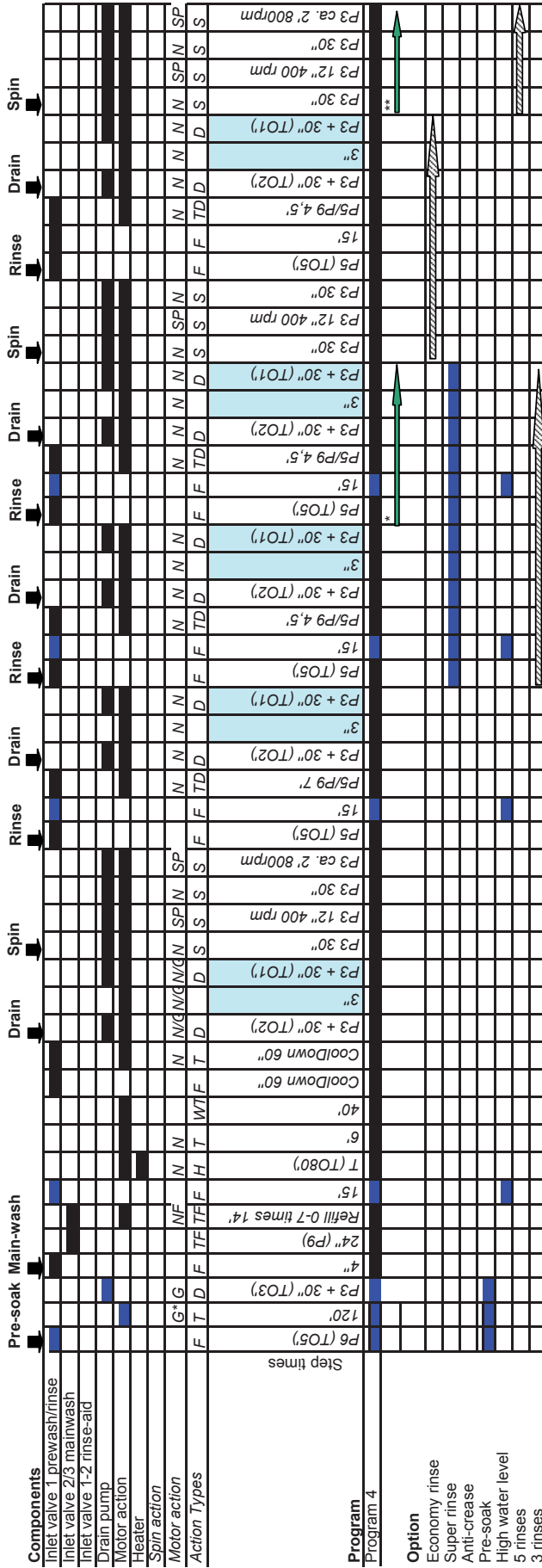

Continue on next page

* When 5 rinses and superrinse, this step is executed
 ** if superrinse this step is executed

Notes