

Product: Front-loading washing machine	Overview of new/modified types of washing machines introduced to the market in 2001	Group: 21
Date: 11.1.2002		
Reference: N-Å Carlsson		Page:1(14)

ASKO Cylinda's range of washing machines was modified during the autumn of 2001. A brief overview of the modifications which were carried out follows below.

Further information is given in the product data given below.

New type	Replaces old type	Main differences	Product info
WM33A	WM33	Programmer no longer fitted, replaced by rotary switch and electronic control card. E2 no longer fitted, new programs. New panel graphic.	A
WM44A	WM44	Programmer no longer fitted, replaced by rotary switch and electronic control card. E2 no longer fitted, new programs. New panel graphic.	A
WM50	NEW	Electronic control with knob and 7-segment LED display. 11 programs.	B
WM55A	WM55	New control card. New menu logic. New programs. Among other things, 1-24 hour delayed start. New panel graphic. Shop program indicated on the display.	C
WM56	NEW	Electronic control with buttons and display. 8 programs. Shop program indicated on display.	D
WM66A	WM66	See WM55A.	C

Produkt: Frontloaded	Modified washing machine WM55A/WM66A	Group: 21
Date: 2002-01-11		C
Reference: N-Å Carlsson		Page: 2(14)

Content

- Example of panel
- General
- Instruction on EasyControl menu logic
- Menu system for changing preset program
- Occasional spin or rinse
- Available options/default settings
- Preselected programs, 5- and 3-rinse
- Available programs, 5- and 3-rinse
- Consumption values
- Switching shop program on and off
- Test program/faultfinding
- Loops on control card
- Reprogramming
- Component and measured values

This service manual is intended as a supplement to the W600 series Service Manual.
Example of WM55A/ 66A Panel

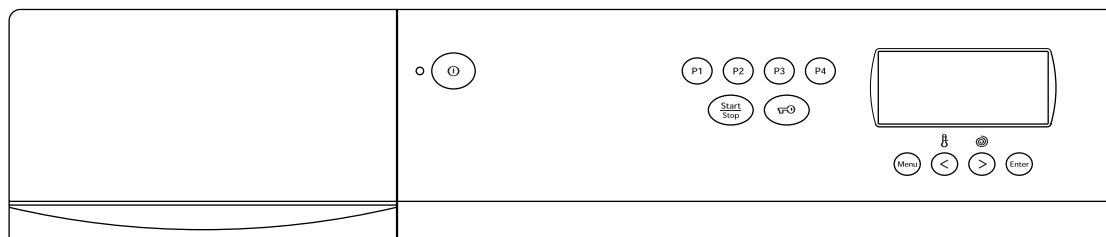

General

Mechanically the machine is based on the WM55 (W640/W650) and WM66 (W660) respectively, except for the panel and control unit. For more information see the service manual for the W600 series. The difference in operation between the WM55/WM66 and WM55A/WM66A is that the new machines are provided with a new menu logic, new preset programs, new program types and different options. The machines also include a shop program for indication on a display intended for dealers.

Instruction regarding EasyControl menu logic

CREATING YOUR OWN WASH PROGRAM

1. Press the button **P1** **P4** where this program is to be stored. If you only want to run an occasional program you may select any button.
2. Step forward with the **Menu**- button to the setting or option you want to change. If the child lock is activated nothing happens. In that case keep the button pressed for 3 seconds, then press again as usual. All program types, settings and options are described in a separate table.

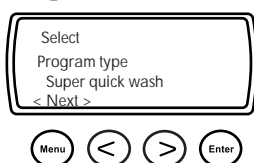

3. If you want to change a setting step forward or back with the **<** **>** button until the desired setting appears on the display.

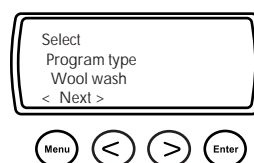

4. Then step forward with the **Menu**- button until the next setting/option, change in the same way if you so require.
5. Repeat this until the finished program appears on the screen together with the spin speed, any temperature and options. The word Stop appears on the bottom line.

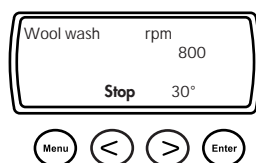

You can now use the program without storing it (occasional program). Close the door and press the **Start/Stop**-]button to start the program.

Storing the program permanently

If you want to store the program so that it is used whenever you wash, press the **Enter**- button before starting. The symbol representing the button you selected to start with (P1-P4) appears on the bottom left of the display.

You can now select the program by pressing the button you selected in Stage 1.

N.B. The option Delayed start and temperatures over 60°C is not permanently stored.

IMPORTANT!

If you store a program by mistake you can reset it to what it was on delivery, see Reset program, further on in this chapter.

HINT!

If you do not want to step through all the settings/options you can end the feed by pressing the **Enter**- button ONCE.

To store the program you press the **Enter**-button once again.

Interrupting the feed

If you change your mind and want to interrupt during feeding, switch off the machine with the main switch **⊙**. When you turn it on again you can start again from the beginning and select any of the preset programs as usual.

Resetting programs

If you want to return to the setting a preset program had when the machine was delivered, you can reset it.

1. Keep the program button (P1-P4) pressed for the program you want to reset.
2. Press the **Enter**- button once.
3. Release the program button.

The program for the button has now been reset to what it was when the machine was delivered.

The menu system for changing a preset program

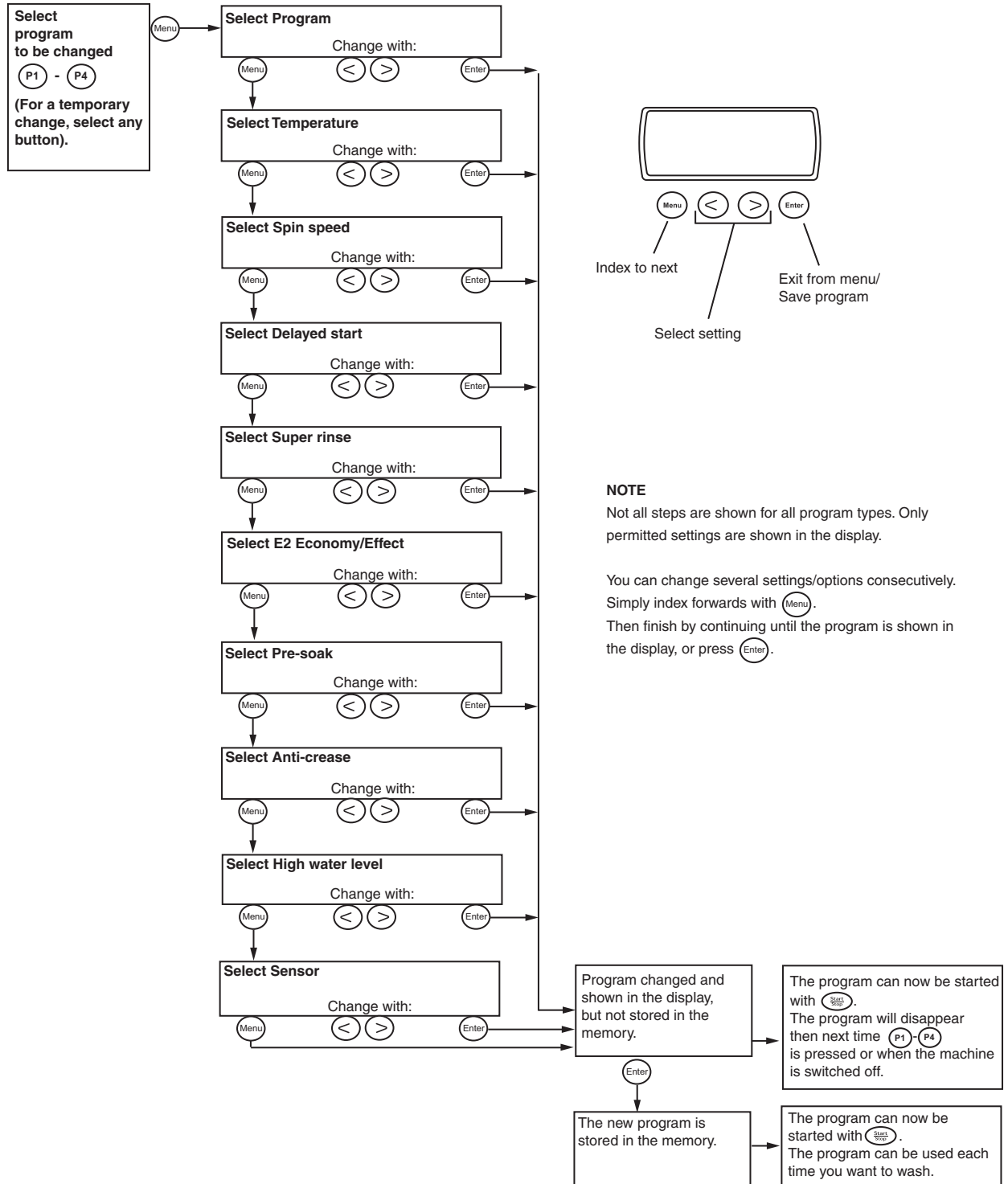

Occasional spinning or rinsing

If you want to run a spin or rinse program only occasionally, without changing (P1)-(P4), you may do so as follows:

1. Load the wash and close the door.
2. Press the (P1) -button once.
3. Press the (Menu) -button once.
4. Step forward with (<) (>) until the Spin or Rinse program appears on the display.
5. Press the (Enter) -button once. The selected program appears on the display.
6. Adjust the Spin speed by stepping forward with (>) if so required.
7. Press (Start/Stop) to start the program.

Occasional options

Setting/Option	Description	Limitations
Program types	Available programs are described in a separate table in this chapter. When the program type is changed all options and settings are set to their original values.	
Temperature C, 30-95°C	The temperature can be adjusted at any time by pressing the button before starting. C denotes the temperature of the incoming water. Temperatures over 60°C are not permanently stored.	For some program types it is only possible to select temperatures of between 30 and 40°C. See table.
Spin speed 400-1600 rpm No spin No drain	The speed to be displayed when the preset program (P1-P4) has been selected is selected here. No spinning takes place if No spin and No drain are selected. No drain allows the water to remain in the machine or wash. A setting can be changed at any time by pressing the button before starting.	For some program types a speed of only 400-8080 rpm can be selected. See table. .No spin and No drain cannot be selected for the program types Spin and Drain
Delayed start (0...24 hours)	If you select Delayed start to five hours, for example, the machine will start five hours after you have pressed the start button. The time until start appears on the display. Changes in this option are not permanently stored.	Can be used on all programs.
Super rinse	Super rinse On adds extra rinses in the wash programs. See table.	Cannot be selected for the program types Rinse program, Spin and Drain.
E2-Economy/Efficiency	E2-Economy/Efficiency On extends the main wash by approx. 22 minutes. For more information on how to use E2, see Chapter 8, Before you wash, in the instructions for use.	Can only be selected for the programs Heavy wash, Normal wash and Light wash.
Pre-soak	Pre-soak On means that the wash will be soaked for two hours before the main program starts.	Cannot be used for the program types Rinse program, Spin and Drain.
Anti-crease	Non-crease On means that the machine rotates the drum for a few seconds every minute two hours after the end of the program. During this time you can end the program by pressing the door open button.	Cannot be used together with No spin and No drain. Cannot be selected for the program types Rinse, Spin and Drain.
High water level	High water level On means that an extra amount of water is used in the main wash and rinses.	Cannot be selected for the programs Wool wash and Hand wash. They already have a high water level.
Sensor function	The rinse sensor function On means that the machine rinses the wash free of washing powder residues without consuming an unnecessary amount of water.	Cannot be selected for the program types Quick wash, Super quick wash, Rinse program, Spin and Drain

Default settings

Program information		Settings and options								
	Program type	Temperature °C	Spin speed rpm	Delayed start (A)	Super rinse	E2 Energy/Efficiency	Pre-soak	Anti-crease	High water level	Rinse sensor WM66A only
P1	Normal wash	60°C	1600	0 tim	Off	Off	Off	Off	Off	On
P2	Light wash	40°C	1200	0 tim	Off	Off	Off	Off	Off	On
P3	Super quick wash	40°C	800	0 tim	Off	(B)	Off	Off	Off	(B)
P4	Hand wash	30°C	800	0 tim	Off	(B)	Off	Off	(C)	POna

(A) 0 hours means that the option has not been activated. This option can only be changed occasionally.

(B) This option cannot be selected for the current program type.

(C) This option is always switched to the current program type and cannot be switched off.

WM5566-OPT

Preselected programs, 5-rinse

Program information				Program content							
	Program type	Max. load	Temperature °C (A)	Spin speed (A) rpm	Prewash	Main wash	Spin	Rinse	Spin	Rinse	Spin
P1	Normal wash	● 60°C	1600			■	⊖	🧺🧺🧺	⊖	🧺🧺	⊖
P2	Light wash	● 40°C	1200			■	⊖	🧺🧺🧺	⊖	🧺🧺	⊖
P3	Super quick wash	◐ 40°C	800			■		🧺🧺			⊖
P4	Hand wash (B)	◑ 30°C	800			■		🧺🧺🧺			⊖

- 1/1 (6,0 kg) ■ Wash ⊖ Short spin (800 rpm max.)
 ◐ 1/2 (3,0 kg) 🧺 Rinse ⊖ (A) Can be changed before start, see instruction
 ◑ 1/3 (2,0 kg) 🌀 Long spin ⊖ (B) Economy run – high water wash.

WMS566-P14-5

Preselected programs, 3-rinse

Program information				Program content							
	Program type	Max. load	Temperature °C (A)	Spin speed (A) rpm	Prewash	Main wash	Spin	Rinse	Spin	Rinse	Spin
P1	Normal wash	● 60°C	1600			■	⊖	🧺	⊖	🧺	⊖
P2	Light wash	● 40°C	1200			■	⊖	🧺	⊖	🧺	⊖
P3	Super quick wash	◐ 40°C	800			■		🧺			⊖
P4	Hand wash (B)	◑ 30°C	800			■		🧺		🧺	⊖

- 1/1 (6,0 kg) ■ Wash ⊖ Short spin (800 rpm max.)
 ◐ 1/2 (3,0 kg) 🧺 Rinse ⊖ (A) Can be changed before start, see instruction
 ◑ 1/3 (2,0kg) 🌀 Long spin ⊖ (B) Economy run – high water wash.

WMS566-P14-3

Available programs, 5-rinse

Program information				Program content							Other		
Program number	Program	Max. load	Temperature °C (A)	Max. spin speed rpm	Prewash	Main wash	Spin	Rinse (B)	Spin	Rinse (B)	Spin		
1	Heavy wash	●	C,30-95	1500	■	■	⊙	🧺🧺🧺	⊙	🧺🧺	⊙		
2	Normal wash	●	C,30-95	1500		■	⊙	🧺🧺🧺	⊙	🧺🧺	⊙		
3	Light wash	●	C,30-95	1500		■	⊙	🧺🧺🧺	⊙	🧺🧺	⊙	Shorter for main wash than for normal wash	
4	Synthetic wash	◐	C,30-95	800		■	⊙	🧺🧺🧺			⊙		
5	Quick wash	●	C,30-95	1500		■		🧺🧺🧺			⊙		
6	Super quick wash	◐	C,30-95	1500		■		🧺🧺			⊙		
7	Wool wash(C)	◐	C,30-40	800		■		🧺🧺🧺			⊙		
8	Hand wash (C)	◐	C,30-40	800		■		🧺🧺🧺			⊙	Slightly more economic than Wool wash	
9	Rinse program	●		1500				🧺			⊙		
10	Spin	●		1500							⊙		
11	Drain	●	Pumping out only										

● 1/1 (6,0 kg)

◐ 1/2 (3,0 kg)

◑ 1/3 (2,0 kg)

■ Wash

🧺 Rinse

⊙ Short spin (800 rpm max.)

⊙ Long spin

(A) C in the display denotes the temperature of the incoming water.

(B) In Super Rinse On two extra rinses are added before the last normal rinse.

(C) Economy run – high water level.

WM505566-5

Available programs, 3-rinse

Program information				Program content							Other			
Program number	Program	Max. load	Temperature °C (A)	Max. spin speed rpm	Prewash	Main wash	Spin	Rinse (B)	Spin	Rinse (B)	Spin	Rinse (B)	Spin	
1	Heavy wash	●	C,30-95	1500	■	■	⊙	🧺	⊙	🧺	⊙	🧺	⊙	
2	Normal wash	●	C,30-95	1500		■	⊙	🧺	⊙	🧺	⊙	🧺	⊙	
3	Light wash	●	C,30-95	1500		■	⊙	🧺	⊙	🧺	⊙	🧺	⊙	Shorter for main wash than for normal wash
4	Synthetic wash	◐	C,30-95	800		■		🧺		🧺		🧺	⊙	
5	Quick wash	●	C,30-95	1500		■		🧺		🧺		🧺	⊙	
6	Super quick wash	◐	C,30-95	1500		■		🧺		🧺			⊙	
7	Wool wash(C)	◐	C,30-40	800		■		🧺		🧺		🧺	⊙	
8	Hand wash (C)	◐	C,30-40	800		■		🧺		🧺		🧺	⊙	Slightly more economic than Wool wash
9	Rinse program	●		1500				🧺					⊙	
10	Spin	●		1500									⊙	
11	Drain	●	Pumping out only											

● 1/1 (6,0 kg)

◐ 1/2 (3,0 kg)

◑ 1/3 (2,0 kg)

■ Tvätt

🧺 Sköljning

⊙ Short spin (800 rpm max.)

⊙ Long spin

(A) C in the display denotes the temperature of the incoming water.

B) In the Super Rinse On option:

For programs 1-3 four rinses are added and one spin disappears.

For programs 4-8: two extra rinses are added before the final normal rinse.

(C) Economy run – high water level.

WM505566-3

Consumption values

WM55A

The following conditions apply to the consumption values indicated below:

Temperature of the incoming water: 15°C.

Element power: 2000 W.

PROGRAM	MATERIAL/WASH TEMPERATURE (1)	LOAD (2)	WATER CONSUMPTION (approx. litres)	ENERGY CONSUMPTION (approx. kWh)	PROGRAM TIME (approx. minutes)
P1 Normal wash	Cotton, linen, 60 °C	5,0 kg	5-rinse: 59 3-rinse: 49	0,95	125 120
P2 Light wash.	Cotton, linen, 40 °C	5,0 kg	59 49	0,90	85 80
P3 Super quick wash	Anti-crease, polyester/cotton, 40 °C	3,0 kg	22	0,30	35
P4 Hand wash	Wool/hand wash, IWS, superwash, 30 °C	2,0 kg	54	0,30	40

(1) All programs are set to the highest spin speed that can be selected.

(2) the machine has a maximum loading capacity of 6.0 kg.

WM66A

The following conditions apply to the consumption values indicated below:

Temperature of the incoming water: 15°C.

Element power: 2000 W.

PROGRAM	MATERIAL/WASH TEMPERATURE (1)	LOAD (2)	WATER CONSUMPTION (approx. litres)	ENERGY CONSUMPTION (approx. kWh)	PROGRAM TIME (approx. minutes)
P1 Normal wash	Cotton, linen, 60 °C	5,0 kg	5-rinse: 59 3-rinse: 49	0,95	125 120
P2 Light wash	Cotton, linen, 40 °C	5,0 kg	59 49	0,90	85 80
P3 Super quick wash	Anti-crease, polyester/cotton, 40 °C	3,0 kg	22	0,30	35
P4 Hand wash	Wool/hand wash, IWS, superwash, 30 °C	2,0 kg	54	0,30	40

(1) All programs are set to the highest spin speed that can be selected.

(2) the machine has a maximum loading capacity of 6.0 kg.

Switching the shop program on and off

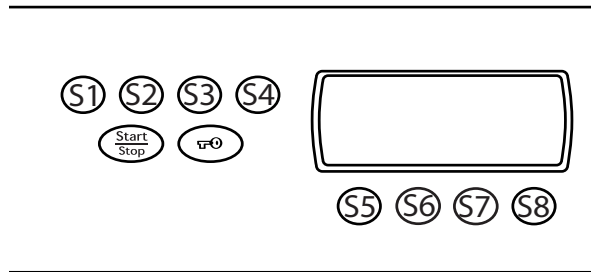

Switching on

1. Switch the machine off and on with the main switch
2. Press 5 x  + S8 + S7 + S6 + S5 + S8 + S7 + S6 + S5
3. Wait 30 seconds.

Step 1 must be executed within 14 seconds.

Switching off

Proceed according to Step 1 and wait 30 seconds before returning to the normal position.

Test program/faultfinding for WM55A/66A

Activation:

1. Switch the machine off and on with the main switch.
2. Press 5 x S5 or short-circuit via E14 and press S9.

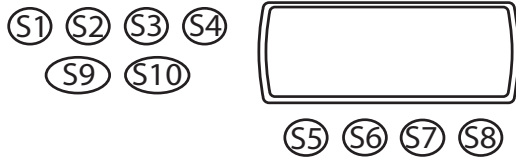

5 x S5	Test program	Test 1	Test 2
		<p>S1= No function S2= Inlet valve 1 S3= Inlet valve 2 S4= Inlet valve 3 S5= Inlet valve 4 S6= Door solenoid S7= Heater relay</p> <p>S8= Switch to Test 2 or</p> <p>S9= Exit test program</p>	<p>S1= No function S2= Drain pump S3= motor Normal action S4= motor Gentle action S5= Spin S6= Test Wash Process Sensor</p> <p>S8= switch to Test 1</p>

Loops on WM55A control card.

Loops and their function

Control unit Art. no. 8064257

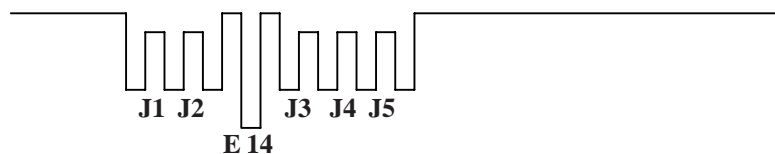

Loop	Option	Not broken/Closed	Broken/Open
J1	Not used		
J2	Not used		
J3	Number of rinses	3 rinses	5 rinses
J4	Foam indications	Off	Off
J5	Not used		

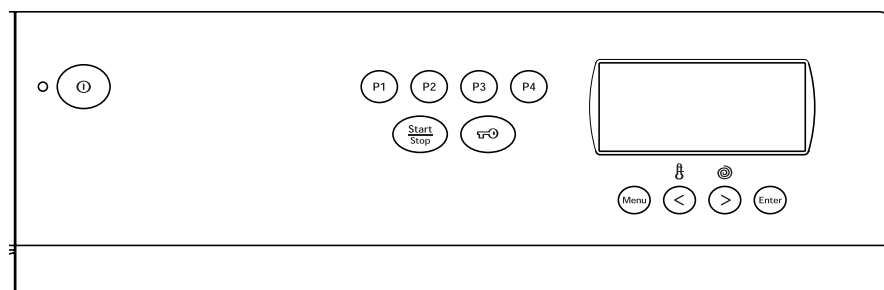

Reprogramming of display and button functions:

Programs must be in 0 position.

Change language.

5 x Enter + 5 x P1.

Change language with < or >

Change from Celsius to Fahrenheit.

5 x Enter + 5 x P2.

Change setting with < or >

Setting of child-safe Start and Menu.

5 x Enter + 5 x P3.

Change setting with < or >, 0 or 3 secs.

Setting of water intake.

5 x Enter + 5 x P4.

Change settings with < or > and the Enter button, <=C = Cold, > Hot and Enter = E = Mixing.

Setting of spin speed.

5 x > + 5 x <.

Change settings with left arrow key < 1300, 1400, 1500 eller 1600 rpm.

Reset program.

Hold down current program and press Enter

Loops on WM 66A control card

Loops and their function

Control unit Art. no. 8064265

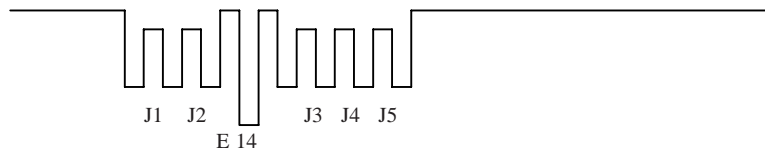

Loop	Option	Not broken/Closed	Broken/Open
J1	Not used		
J2	Not used		
J3	Number of rinses	3 rinses	5 rinses
J4	Foam indication.	OFF	OFF
J5	Not used		

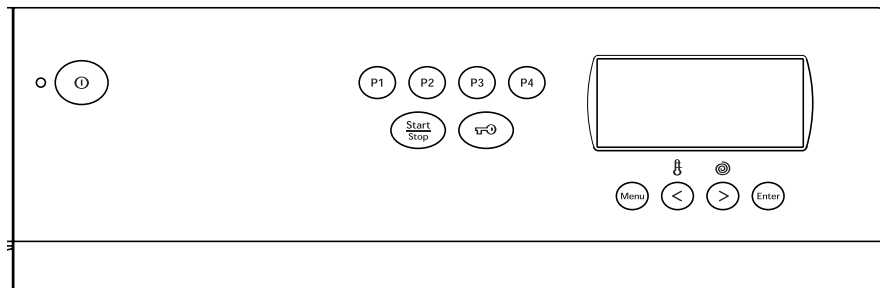

Reprogramming of display and button functions:

Programs must be in 0 position.

Change language.

5 x Enter + 5 x P1.

Change language with the arrow keys.

Change from Celsius to Fahrenheit.

5 x Enter + 5 x P2.

Change setting with the arrow keys < or >

Setting of child-safe Start and Menu.

5 x Enter + 5 x P3.

Change setting with the arrow keys < or >, 0 - 3 secs.

Setting of water intake.

5 x Enter + 5 x P4.

Change settings with the arrow keys and the Enter button, <=C = Cold, > Hot and Enter = E = Mixing.

Setting of spin speed.

5 x > + 5 x <.

Change settings with left arrow key < 1300, 1400, 1500 or 1600 rpm.

Reset program.

Hold down current program and press Enter

Reset WM66A sensor

5 x menu + key + start.

Components and measured values

WASHING MACHINE MOTOR

WM 50/55A/56/66A (FHP)

Art.no. 80 637 34 (50/60 Hz)

Resistances:

Pins 5-6 Stator 1,58 W

Pins 7-6 Stator 0,87 W

Pins 3-4 Rotor 1,20 W*

Pins 1-2 Tacho 135 W

*) 1,20 W measured diagonally across collector.

All resistance values are $\pm 8\%$.

MOTOR CONTROL UNIT WM 50/55A/56/66A

Art.no. 80 613 99

The motor control unit is an external unit (MCU) which is installed on the bottom and connected to the program control card (PCU), see electrical diagram.

ELEMENT

2000 W

Art.no. 80 617 06

Resistance: 28,4 W

1000 W

Art.no. 80 617 07 (Certain models)

Resistance: 56,7 W

THERMISTOR

Art.no. 80 616 63

Resistance: 65-35 kW

Room temperature 20-30 °C

The thermistor for temperature measurement is installed between the motor cradle and the tank.

The thermistor measures and controls the water temperature, which may vary from 0-90 °C.

The element is disconnected if the thermistor is short-circuited or disconnected from the program control card or programmer.

DRAIN PUMP

50 Hz

Art.no. 80 616 96

N.B. Ordered under art.no. 88 011 66.

Resistance: 144 W

Current: 0,2 A, 23 W loaded

60 Hz

Art no. 80 619 37

N.B. Ordered under art.no. 88 011 67.

Resistance: 76 W

Current: 0,3 A, 28 W loaded

The drain pump is combined with an integrated needle trap, which can be cleaned by the user.

If the drain pump has run for 180 seconds during draining, the program is stopped, reset and an error code appears on the display.

RINSE SENSOR, RPS (WM66A)

Art.no. 80 628 16

ASKO Rinse sensor type 6622.

The rinse sensor is installed next to the drain pump and controls the turbidity of the outgoing rinsing water. The sensor is connected to the PCU, see electrical diagram.

LEVEL SWITCH

Art.no. 80 642 75

An electromechanical level switch with two levels, see wiring diagram. Controls the water level and starts the drain pump if Over flow is indicated.

Components and measured values

LEVEL SENSOR

Art.no. 80 616 64
ASKO Level sensor type 1166.
Voltage:
0,5 V output from the sensor at pressure 0 and 0-level is reached during pumping out.
Measurement by control unit.

The level sensor is mounted on the bridge for electrical components and connected to the PCU, see electrical diagram.

RADIO SUPPRESSION FILTER

Art.no. 80 585 58
Leakage current 230 V/ 50/60 Hz 0,3-0,4 mA

The filter eliminates radio interferences in the machine.

INLET VALVES

3-way inlet valve

Art.no. 80 617 57
Resistance: $3,7 \text{ k}\Omega \pm 0,5 \text{ k}\Omega$
Current: 0,02 A, 5 W

Inlet valve for hot water (option)

Art.no. 80 617 29
Resistance: $3,7 \text{ k}\Omega \pm 0,5 \text{ k}\Omega$
Current: 0,02 A, 5 W

INDICATING LAMP (WM50/55A/66A)

Art.no. 80 640 68 USA
Current: 230 V, 50 Hz 1,7 mA

Art.no. 80 640 69 EU
Current: 230 V, 50 Hz 1,7 mA

The lamp indicates that the main switch is turned on.

DOOR LOCK

Art.no. 80 616 79
Resistance: 122Ω
Current: ca 2 A

The door lock is mechanical and is controlled by the button for door opening and different safety devices.

PROGRAM CONTROL CARD (WM50/55A)

Art. no. 80 642 57

PROGRAM CONTROL CARD (WM66A)

Art. no. 80 642 65

PANEL CARD (WM55A/56/66A)

Art.no. 80 642 73 (ASKO)
Art.no. 80 642 74 (OEM)
Art.no. 80 653 28 (ASKO)
Art.no. 80 653 29 (OEM)

FUSE

Art.no. 80 554 21 6,3 A (EU)
80 581 40 15 A (US)