

dacor[®]

The Life of the Kitchen.[®]

Service Manual
Built-In Dishwasher

TABLE OF CONTENTS

Section 1 - Safe Servicing Practices	1-1	Door Spring.....	4-7
Section 2 - Operation	2-1	Hinge "C" Arm	4-7
Static Fill.....	2-1	Door Seal Retainer.....	4-8
Dynamic Fill.....	2-1	Pressure Switch Assembly.....	4-8
Wash System.....	2-2	Thermistor/Soil Sensor	4-9
Soil Sensing	2-2	Inline Heater	4-9
Main Wash/Temp Assure.....	2-3	Drain Pump.....	4-10
Temperature Controls.....	2-3	Wash Motor	4-10
Rinse Phases	2-4	Capacitor	4-11
Condensate Drying.....	2-4	Blower Assembly	4-12
Section 3 - Cycle, Systems & Components	3-1	Sump.....	4-12
Dishwasher Control.....	3-1	Side Vent and Fill Hose.....	4-13
Auto Wash.....	3-1	Section 5 - Troubleshooting Tips	5-1
Heavy Wash.....	3-1	Section 6 - Parts Breakdown	6-1
Normal Wash	3-1	Section 7 - Electrical Diagram	7-1
Short Wash.....	3-1		
Rinse Hold.....	3-1		
Component Function Test	3-1		
Water/Service Test	3-1		
Entering the Water/Service Test.....	3-2		
Water Temperature Test Mode	3-2		
Soil Sensor Test Mode	3-3		
Electronic Control and Keypad Assembly	3-3		
Control Board Plugs.....	3-3		
Fill System	3-3		
Inlet Water Valve	3-3		
To Check Inlet Water Valve	3-4		
Pressure Switch Assembly	3-4		
Low Water Level Switch	3-4		
Checking Low Water Level Switch.....	3-5		
High Water Level Switch	3-5		
Checking High Water Level Switch	3-6		
Wash Motor	3-6		
Checking the Wash Motor.....	3-6		
Checking the Tachometer	3-6		
Heater	3-7		
Temperature Sensor and Soil Sensor	3-7		
Checking the Thermistor	3-7		
Checking the Soil Sensor.....	3-8		
Drain Pump	3-8		
Checking the Drain Pump	3-8		
Dispenser	3-9		
Checking the Dispenser	3-9		
Fan Dry Unit	3-10		
Checking Fan Dry Motor.....	3-10		
Section 4 - Service & Disassembly	4-1		
Safety Precautions	4-1		
Door Panel	4-1		
Control	4-1		
Dispenser	4-2		
Lower Access Panel	4-2		
Door Latch/Door Switch	4-2		
Upper Spray Arm	4-3		
Lower Spray Arm	4-3		
Center Spray Arm and Upper Rack Manifold	4-4		
Main Delivery Tube	4-4		
Upper Spray Arm Mount	4-5		
Bottom Door Seal	4-5		
Door Seal	4-5		
Water Valve	4-6		
Cabinet Removal	4-6		

Section 1 - Safe Servicing Practices

To avoid personal injury and/or property damage, it is important that **Safe Servicing Practices** be observed. The following are some limited examples of safe practices:

1. **DO NOT** attempt a product repair if you have any doubts as to your ability to complete it in a safe and satisfactory manner.
2. Before servicing or moving an appliance:
 - Remove the power to unit.
 - Turn off the gas supply.
 - Turn off the water supply.
3. Never interfere with the proper operation of any safety device.
4. **USE ONLY REPLACEMENT PARTS CATALOGED FOR THIS APPLIANCE. SUBSTITUTIONS MAY DEFEAT COMPLIANCE WITH SAFETY STANDARDS SET FOR HOME APPLIANCES.**
5. **GROUNDING:** The standard color coding for safety ground wires is **GREEN**, or **GREEN** with **YELLOW STRIPES**. Ground leads are not to be used as current carrying conductors. It is **EXTREMELY** important that the service technician reestablish all safety grounds prior to completion of service. Failure to do so will create a hazard.
6. Prior to returning the product to service, ensure that:
 - All electrical connections are correct and secure
 - All electrical leads are properly dressed and secured away from sharp edges, high-temperature components, and moving parts
 - All non-insulated electrical terminals, connectors, heaters, etc. are adequately spaced away from all metal parts and panels
 - All safety grounds (both internal and external) are correctly and securely connected
 - All panels are properly and securely reassembled



ATTENTION

This service manual is intended for use by persons having electrical and mechanical training and a level of knowledge of these subjects generally considered acceptable in the appliance repair trade. Dacor cannot be responsible, nor assume any liability, for injury or damage of any kind arising from the use of this manual.

Section 2 - Operation

In order to address service issues with the Dacor Built-In Dishwasher, the primary elements of its operation are described below, as well as its physical components.

Static Fill

The cycle begins by activating the drain pump, ensuring the sump is empty. Operation then proceeds to the fill stage where the fill valve regulates inlet water to 1.08 GPM between 20 and 120 psi. A fill hose is attached to the fill valve and clamped to the bottom of an air gap mounted on the left hand side of the tub. (The air gap prevents the siphoning of wash water back into the water supply system should the water pressure drop to less than atmospheric pressure.) The inlet water enters the tub through the vent opening on the left sidewall of the tub. As the fill continues, both the time of the fill and the amount of water in the sump are monitored by the electronic control.

The pressure switch assembly mounted to the right side front frame has two pressure switches; a low water level and a high water level switch. The contact in the low water level switch is open until the water reaches the proper level in the sump. At this point, the switch closes (neutral to P3-9), starting the Dynamic Fill.

Dynamic Fill

The closed circuit from the pressure switch starts the wash motor. The wash motor gains speed at the rate of 100 RPM/second until full speed is attained. The water level inside the sump falls as the wash motor gains speed. This opens the circuit on the low level pressure switch, allowing the water valve to introduce more water to the tub. Once the wash motor reaches full speed, the inlet water continues to fill until the low level pressure switch is reactivated (neutral to P3-9). This completes the fill phase of the cycle.

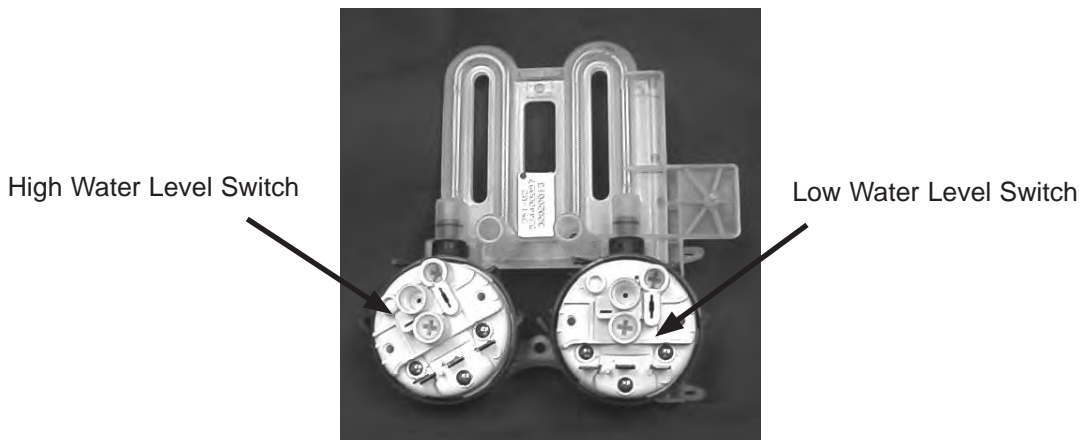

PRESSURE SWITCH ASSEMBLY – FIGURE 1

Wash System

Once filling is complete, the dishwasher enters the pre-wash phase. The pre-wash phase conditions the soil with water and detergent to prepare it for removal in the main wash phase.

Once water enters the tub, the pump draws the water into the sump through a primary filter at the bottom of the tub to prevent food from circulating through the wash system and redepositing on the dishes. In the center of the primary filter is the lower spray arm and drain filter assembly. The drain cap, snapped into the drain cup, prevents food particles from entering the drain section of the sump.

As the wash water flows through the filters, soil levels and water temperatures (see Soil Sensing section, this page) are measured by the Soil Sensor/Thermistor assembly. The wash motor discharges the wash water through two ports, feeding the lower, center, and upper spray arms. The larger of the ports feeds water through a "Y" hose to separate the lower and center spray arm wash water. The water flowing to the center spray arm first passes through an inline water heater before entering the delivery tube. The water flowing to the lower spray arm passes through the sump on its way to the lower spray arm.

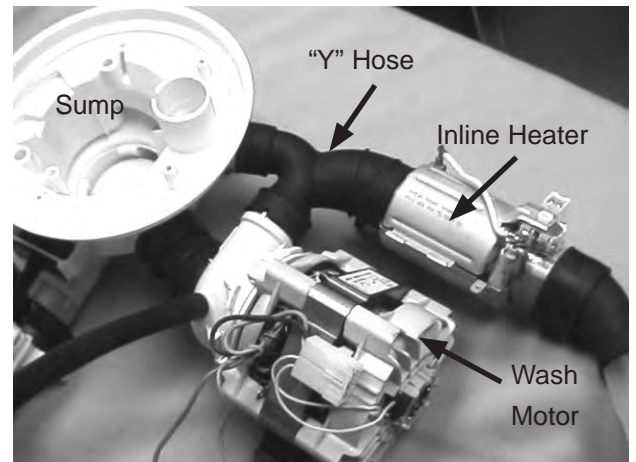

FIGURE 2

Soil Sensing

Soil sensing is performed in all wash cycles except the Rinse Only cycle. Mounted on the right side of the sump, the soil sensor transmits light from a transmitter to a receiver to measure the amount of soil in the water. This information will be used by the control to determine the length of the cycle.

Once pre-wash loosens food on the dishes, the motor stops for 30 seconds. This allows the wash water and food soils to settle for the soil sensor to check the soil levels in the water.

Now that this reading is taken, the dishwasher drains the dirty water and fills again for the pre-wash rinse. Once this rinse is complete, the wash motor pauses again, a soil level measurement is again taken. The control uses these readings to adjust the wash cycle to ensure a clean load of dishes.

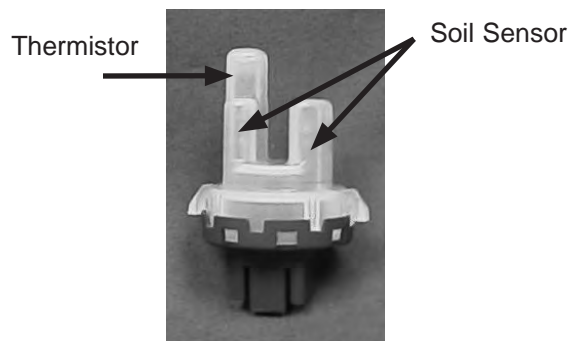

FIGURE 3

Main Wash/Temp Assure

After the final reading by the soil sensor, the unit drains before starting to fill for the main wash. The tub fills, with the wash motor starting after the low level pressure switch is activated. The detergent dispenser now opens, introducing detergent into the wash cycle. The electronic control checks the water temperature through the thermistor, energizing the inline heater to maintain or heat the wash water entering the second level spray arm.

The main wash temperature has been predetermined for the wash cycle selected. At this point, depending on the required temperature (Temp Assure), the electronic control pauses the time remaining to allow the wash water to heat to the desired setting. If Temp Assure is not reached, the dishwasher pauses time between 0 and 10 minutes to allow the temperature to increase during several periods of the main wash. Once the main wash cycle is completed, the dishwasher goes through the drain phase before filling for the rinse phase of the cycle.



INLINE HEATER – FIGURE 4

Temperature Controls

Options allow the consumer the choice to control the temperature at which the main wash operates. The main wash water can be heated to increase the performance of the chosen wash cycle.

If the High Temp option is chosen, the required temperature (Temp Assure) during the main wash is increased to 140°F. The control will pause the time remaining for up to 10 minutes to allow the water to heat to this temperature. Whether or not the water temperature reaches this in 10 minutes, the cycle continues without indication that it reached or did not reach this temperature.

When the Sanitize option is chosen, the National Sanitation Foundation requires, in the final rinse cycle, that 155°F be reached and maintained for a certain amount of time. During the final rinse, the control pauses the time remaining for up to 30 minutes to reach Temp Assure (155°F for Sanitize) before proceeding to the end of the cycle. Should the cycle meet the requirements defined by the Sanitize option, the Sanitize ring will remain lit following the completion of the cycle. The ring will not light if Temp Assure is not met.

Rinse Phases

The first rinse phase follows the pre-wash portion of a wash cycle. During this rinse phase, the motor ramps up by 100RPM/second to full speed (2800RPM). Once at full speed, however, the motor will cycle between 1600RPM and 2800 RPM throughout the rest of this rinse phase. This motor action aids in the removal of food from the dishes so it can be filtered from the water.

The final rinse phase begins, following the end of the main wash. Rinse agent is added to the water during the final rinse. Rinse agent speeds drying, removes water spots, and water streaks from glassware.

If the Sanitize option has been chosen, the control will pause the time remaining to allow the heater to increase the water temperature to 155°F. This delay will last up to 30 minutes before resuming the rest of the cycle. The Sanitize outer ring will light following the wash only if 155°F is achieved.

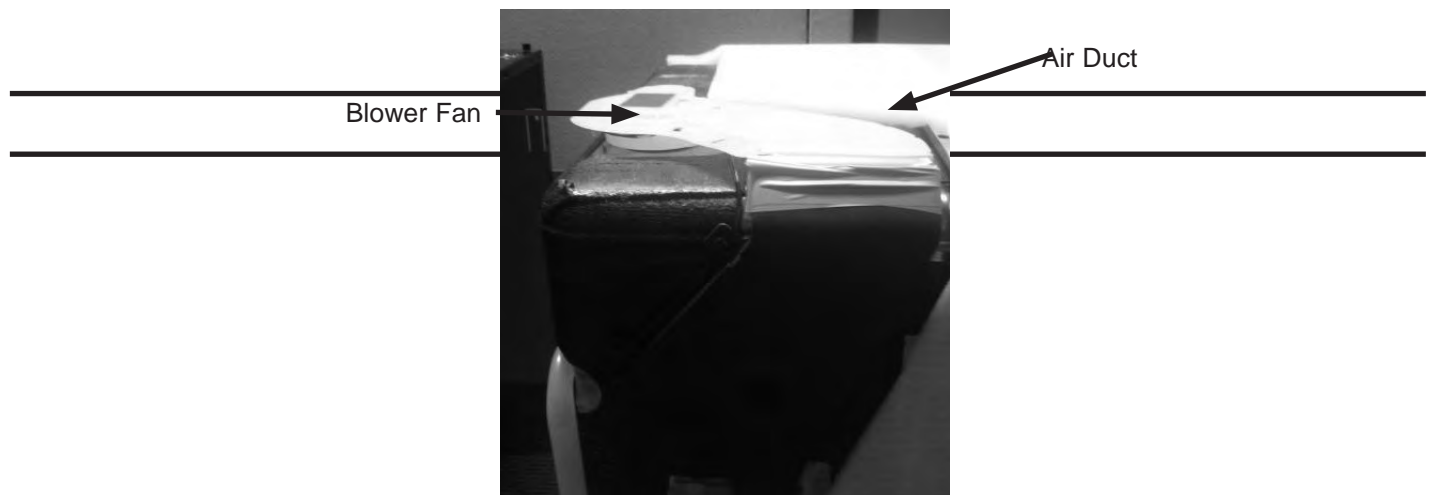

FIGURE 5

Condensate Drying

This dishwasher is designed and equipped with a condensate drying system. Steam is drawn from the tub by the condensate fan and forced through the condensate duct. As it flows through the condensate duct, the cool surface of the baffles condenses the steam into water allowing the now cooler and drier air to exit into the tub through the condensate vent. The condensate vent is also the exit for the water from the condensate duct into the tub to be drained.

This circulation starts before the unit has completed draining and continues for the rest of the drying phase of the wash cycle. The air intake and condensate vent are shown in Figure 6.

The final operation of the wash cycle energizes the fill valve long enough to allow the soil sensor to recalibrate itself with fresh, clean water.

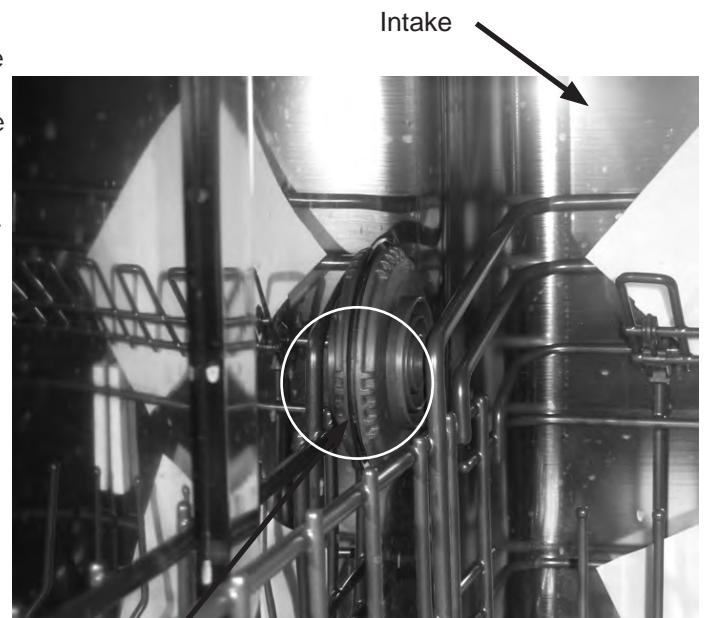

Side Vent
Air Return

Section 3 - Cycle, Systems & Components

Knowledge of the dishwasher's cycles and systems is necessary in diagnosing any potential operational problems. Methods for diagnosing these problems, such as taking resistance readings and testing for closed circuits are outlined in the following section as well.

Dishwasher Control

All of the functions and operations of this dishwasher are dictated and monitored by the electronic control. The control maintains the proper water temperature in the wash and rinse cycles to ensure proper cleaning for the wash cycle selected. (This temperature may not be the same for all cycles.) The control also monitors the soil concentration in the water with the use of a turbidity sensor mounted in the sump.

Auto Wash

This cycle factors in the size of the load, the amount of soil on the dishes, and the temperature of the water to create an appropriate cycle for each load. Auto wash uses water temperature to determine the length of the wash cycle. Water temperature is monitored to assess the rate at which the water temperature decreases. A rapid decrease in temperature alerts the control to extend the wash time. (Larger loads have higher rates of temperature decrease, therefore longer wash cycles.)

As the water is assessed for temperature changes, it is also adjusted to maintain proper temperature throughout the cycle. The control also checks the soil concentration in the water to determine the number of rinses needed for cleaning.

Heavy Wash

This cycle is intended for heavy soil levels. The water temperatures for both wash and rinse cycles are automatically selected. It includes a high temperature wash and sanitize rinse. Soil sensing is used in this cycle.

Normal Wash

This cycle is intended for normal soil level. All options (high temperature wash, sanitize rinse, and delay start) are available at the user's discretion. Soil sensing is used in this cycle.

Short Wash

This cycle is intended for light soil levels. All options (high temperature wash, sanitize rinse, and delay start) are available at the user's discretion. Soil sensing is used in this cycle.

Rinse Hold

This cycle is intended for dishes that are to be washed later. It is a rinse-only cycle; options and soil sensing are not available.

Component Function Test

Water/Service Test

The service test will check the electronic control's ability to run all functions of the dishwasher. This test may be entered from an idle mode or the power failure mode, however different pads are used to activate.

SECTION 3 - CYCLE, SYSTEMS & COMPONENTS

Component Function Test (continued)

Entering the Water/Service Test

From Power Failure

While the control displays power failure or flashing lights, press and hold the Short wash and the Rinse & Hold pads simultaneously for one second. The dishwasher will start through the test cycle.

From Idle

With no cycle selected and the dishwasher sitting idle, press and hold the Hi-temp and the Start pads simultaneously for one second. The dishwasher will start through the test cycle.

The chart below shows the complete Water/Service Test cycle. To manually move to the next phase of the cycle press the Start pad. If at any time the door is opened the test cycle will end and flashing lights will come on showing power failure. The Sanitize LED will light at the end of test to check the LED. If the rinse aid dispenser is empty, the display will read LO to indicate the contact in the dispenser is closed.

Step	Description	Time	Water Valve	Wash Motor	Drain Pump	Heater	Dispenser	Fan	Sensing LED	Drying LED	Sanitized LED	Dispenser Low LED	Clean LED
1	Fill / Dispenser	59	1	0	0	0	0	0	1	0	0	0	0
2	Fill / Dispenser / Wash	21	*	1	0	0	1	0	1	0	0	0	0
3	Wash / Heat	45	0	1	0	1	0	0	1	0	0	0	0
4	Pause	0.6	0	0	0	0	0	1	0	0	0	0	0
5	Wash / Heat	75	0	1	0	1	0	0	0	0	0	0	0
6	Wash / Heat / Dispenser	80	0	1	0	1	1	0	0	0	0	0	0
7	Drain	90	0	0	1	0	0	0	0	0	0	0	0
8	Dry	90	0	0	0	1	0	1	0	1	0	0	0
	Completion	460.6									1	0/1	1
* Dynamic fill - water valve is open until pressure switch is closed													

Water Temperature Test Mode

This test is for testing the thermistor in the sump as well as the control.

1. Start a Normal wash cycle and allow the dishwasher to fill and wash for two minutes at which time, press the Start/Cancel pad twice (2). This will stop the dishwasher and send it to idle.
2. With the dishwasher in idle press and hold the Normal wash and the Start/Cancel pads simultaneously will start the test. The test will show a two digit display for the temperature of the water (from 0°F to 99°F). If the water temperature is over 99°F a decimal point will be displayed to show 100°F, then the added degrees over. This reading will be updated every three seconds until the Start/Cancel pad is depressed to stop the test.

Component Function Test (continued)

Soil Sensor Test Mode

This tests the sensor for proper operation as well as the value that the sensor is detecting.

1. To activate the test you must press and hold the Heavy and Start pads simultaneously.
2. When the test mode is activated, the digit display will show the turbidity value of the sensor. This display will be a voltage reading in the decimal value.
3. To terminate this test press the Start pad.

Electronic Control and Keypad Assembly

The control on the dishwasher consists of the control board and the switch assembly. The switch is installed into the top of the outer door panel, an elastomer keypad, used to actuate the switch, is inserted into holes in the top of the outer door panel. The keypad assembly is attached to the control board with a connecting ribbon. The keypad is held in place by a spacer that is clipped to the top of the mount holding the control board. The control is mounted to a carrier panel that is attached to the outer door panel. It is covered with a mylar blanket.

Control Board Plugs

Throughout this section references are made to the plug and pin location on the electronic control. Figure 7 shows a picture of the electronic control pointing out plug numbers as well as pin and color of the wire in each location.

Plug #1	
#1	Black
#8	Gray

Plug #2	
Black	1
Red	2
Purple	3
Brown	5
Orange	6
White	7

Plug #3	
1	White
2	Brown
3	Blue
4	Black
5	Yellow
6	Brown
7	Black
8	White
9	Orange
10	Blue
11	Red

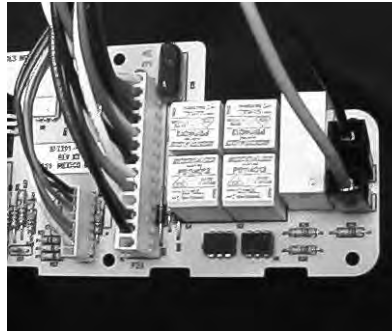

FIGURE 7

Fill System

Two major components in the fill system are the inlet water valve and the pressure switch assembly.

Inlet Water Valve

The inlet valve is an electrically controlled shut-off valve that is used to allow water to enter the dishwasher. The valve has a flow restrictor to regulate the water flow to 1.08 GPM at between 20 and 120 psi into the tub. The inlet valve is wired to the electronic control and is opened and closed by the control. The inlet water valve is located on the front left frame leg just behind the lower front panel.

Inlet Water Valve (continued)

To Check Inlet Water Valve

1. Disconnect dishwasher from power supply.
2. To access electrical connections to valve, remove lower front panel.
3. Using ohmmeter, check between P3-5 (yellow wire) and P3-8 (white wire). The resistance reading of the solenoid coil should be 1126 ohms.

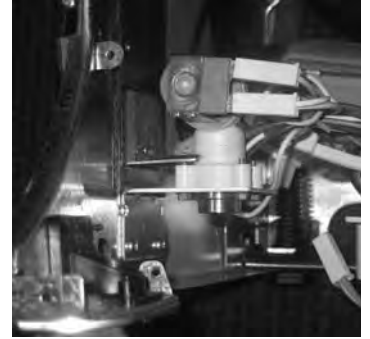

FIGURE 8

Pressure Switch Assembly

The pressure switch assembly consists of a low water level switch and a high water level switch with common bracket. This assembly is mounted to the right side frame behind the junction box.

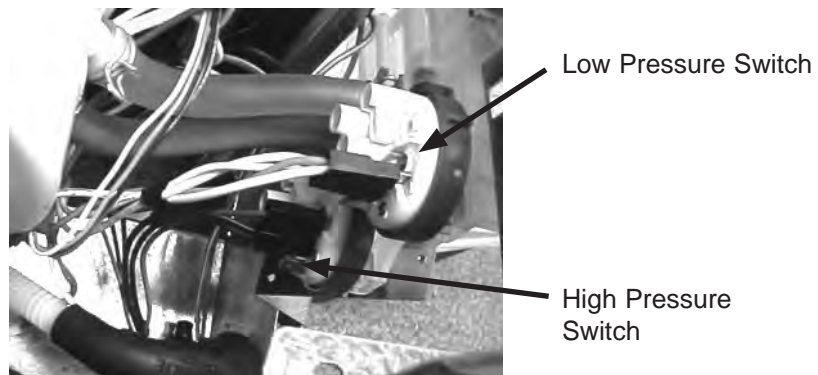

FIGURE 9

Low Water Level Switch

The low water level switch is used to maintain the water level in the sump for the fill cycle. The switch has a hose connecting it to the sump. As the water level in the sump rises, air in the hose is compressed and forced against the diaphragm in the switch. This compressed air causes the contact in the switch to close. When the switch closes the first time, it starts the wash motor.

Low Water Level Switch (continued)

Checking Low Water Level Switch

1. Disconnect power to dishwasher.
2. Gain access to electronic control and check between P3-9 (orange wire) and P3-8 (white wire). This should be an open contact.
3. These wires are connected to center terminal #1 and terminal to the right of center #3.
4. Add water to sump to close switch. (See Figure 10)



Low Water Level Switch will close at this level

FIGURE 10

High Water Level Switch

The high water level switch is a back up, or safety, for the low water level switch. The high water level switch is placed in series with the drain pump. If the low water level switch fails to close, the drain pump starts automatically. The high water level switch is an open switch. It is connected to the sump by a separate hose.

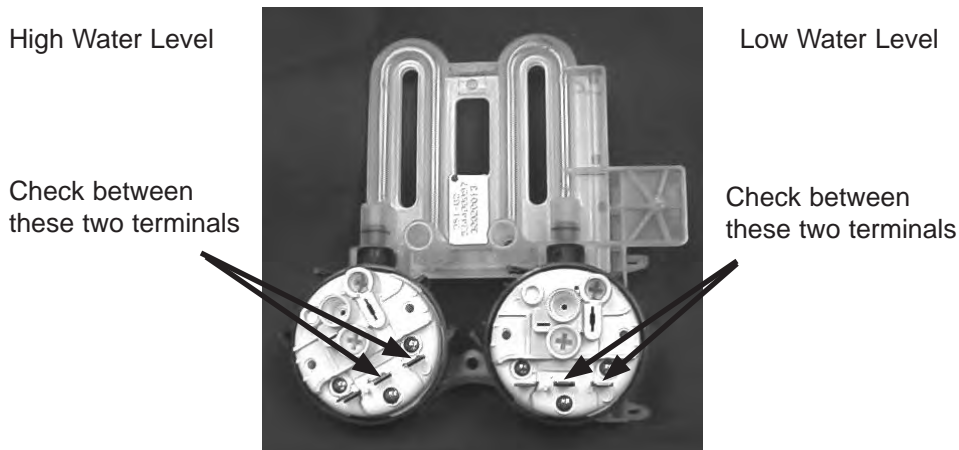

FIGURE 11

High Water Level Switch (continued)

Checking High Water Level Switch

1. Checking continuity through the high water level switch is easier at the control.
2. Disconnect power to dishwasher.
3. Gain access to electronic control and check for continuity between the L1 black wire and P3-6 (brown wire). This contact should be open.
4. These wires are connected to center terminal #1 and terminal to the right of center #3 on the switch.
5. This contact will close when water inside the tub reaches the rails for the lower wash rack.

Wash Motor

The wash motor, mounted to left side of the sump, is connected to it by two separate hoses. The permanent split capacitor motor operates on 120 VAC, 1.8 amp 60 Hz.

The motor speed varies as needed for different wash cycles. The speed varies by changes made to the voltage sine wave, as power is applied to the motor. At full speed the wash motor runs at approximately 2800 RPM.

The motor speed varies at the beginning of the wash cycle as the tub fills with water. After the wash motor starts at 310 RPM, it increases speed at a rate of 100 RPM/second until full speed is reached. The motor speed also varies during Pulse Wash, where the motor speed is changed from 1600 RPM to 2800 RPM to aid in cleaning the filter, while reducing noise.

The electronic control monitors the speed of the motor through the tachometer mounted on the rear of the motor. (See Figure 13) The tachometer is an AC generator, which provides feedback information to the control for regulating the motor speed.



WASH MOTOR – FIGURE 12

Checking the Wash Motor

1. Disconnect dishwasher from power supply.
2. Due to the location of the motor disconnect plug, resistance readings should be made at the control.
 - Remove outer door panel to gain access to the control.
 - The run windings for the motor are connected between P3-1 and P3-4.
3. The resistance should read 14 ohms.

Checking the Tachometer

1. Disconnect dishwasher from power supply.
2. Due to the location of the motor disconnect plug, resistance readings should be made at the control.
 - Remove outer door panel to gain access to the control.
 - The tachometer leads are between P3-10 and P3-11.
 - The resistance should read 246 ohms.

Tachometer mounted on the rear of the motor

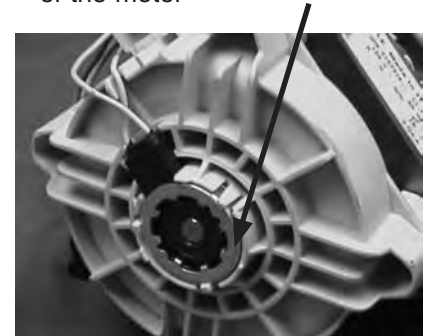

FIGURE 13

Heater

The heater in this dishwasher is inline between the wash motor and the delivery tube. The 1200W heater wraps around a stainless steel core tube. The heater can only be energized, during a wash cycle, while the wash pump is running after the low level pressure switch has been activated. Water is heated as it passes through the heater to the center spray arm. This heater has internal thermal protection.

While checking the heater, do not apply power to it until the tub has filled with water and the motor is operating!



INLINE HEATER – FIGURE 14

Temperature Sensor and Soil Sensor

The electronic control reads information from two sensors to adjust the wash cycle. The Thermistor and soil sensor are integrated into the same housing mounted to the right side of the sump. Both sensors extend into the outer section of the sump to perform independent tasks.

The electronic control uses the Thermistor to monitor the temperature of the water in the dishwasher. The turbidity or soil sensor is used to monitor soil levels during a wash cycle. A small amount of DC power is sent to the soil sensor emitter mounted in one of the posts of the sensor housing. This emitter turns DC power into a small beam of light to be transmitted to a detector in the other post. As this light passes from one post to another, the amount of soil in the water partially blocks the light seen by the detector. The detector changes this light back into DC voltage which returns to the control for analysis.

The level of soil in the water can be determined by this returned voltage. Based on this information, the control makes adjustments to the remainder of the wash cycle.

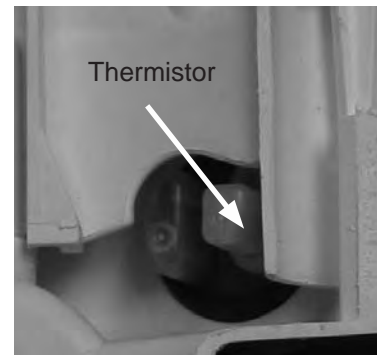

SENSOR MOUNTED INTO SUMP – FIGURE 15

Checking the Thermistor

1. Start a Normal wash cycle and allow the dishwasher to fill and wash for two minutes at which time press the Start/Cancel pad twice (2). This will stop the dishwasher and send it to idle.
2. With the dishwasher in idle, press and hold the Normal wash and the Start/Cancel pads simultaneously to start the test. The test will show a two digit display for the temperature of the water (from 0°F to 99°F). If the water temperature is over 99°F a decimal point will be displayed to show 100°F, then the added degrees over. This reading will be updated every three seconds until the Start/Cancel pad is depressed to stop the test.

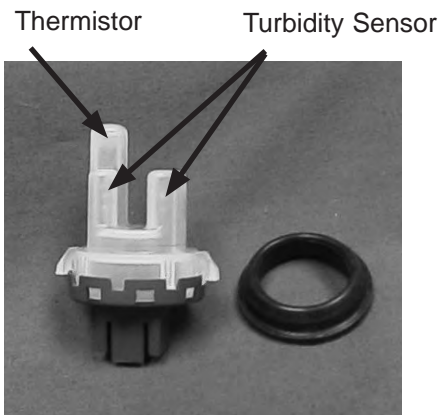

SENSOR WITH SEAL – FIGURE 16

Refer to **Water Temperature Test Mode** on page 3-2 to check the temperature of the thermistor.

Checking the Soil Sensor

1. While in idle mode, simultaneously press and hold Heavy Wash and Start/Cancel buttons.
 - This activates the sensor value test.
 - If a number does not display, continue with the test.
2. Disconnect dishwasher from power supply.
3. Check soil sensor circuit at control.
 - A resistance reading should be taken between P2-1 black and P2-7 white at the control for the emitter.
 - A resistance reading should be taken between P2-2 red and P2-7 white at the control for the detector.

Drain Pump

This dishwasher contains an independent drain pump. It is of a wet rotor design to prevent leaks. The drain pump is mounted directly to the rear of the sump. The pump cover can be removed for cleaning. The discharge end of the pump has a check valve to prevent water and odors from entering the dishwasher from the house drain system. The intake of the pump is connected to the sump by a short connecting hose. The pump is delivered as a complete assembly.

Checking the Drain Pump

A service test can be performed to test all functions of the dishwasher, including the drain pump.

- The service test is covered in section "Component Function Test".

IF THE DRAIN PUMP DOES NOT OPERATE

1. Disconnect dishwasher from power supply.
2. The location of the drain pump requires that you check the circuit at the control.
 - Check between P3-6 brown and P3-8 white.
3. The resistance should read 26 ohms.

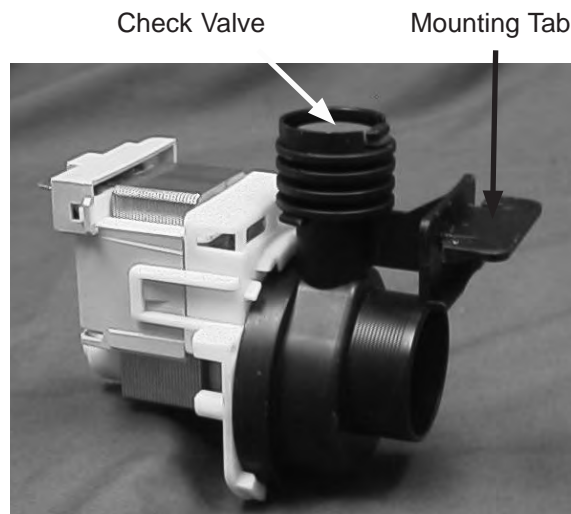

DRAIN PUMP – FIGURE 17

Dispenser

The dispenser consists of two dispensers in one housing, controlled by the use of one wax motor actuator. The first time the actuator is energized in the cycle, detergent is dispensed. The second time the actuator is energized, rinse agent is dispensed.

The rinse aid half of the dispenser can be adjusted to meet the customer's needs. This is done by removing the cap from the dispenser and adjusting the arrow inside to a higher number. The higher the number, the more agent is dispensed during the rinse cycle. A sensor inside the rinse aid reservoir triggers the control to display "LO" when the level of rinse agent is low. The "LO" display on the control will not affect the operation of the dishwasher.

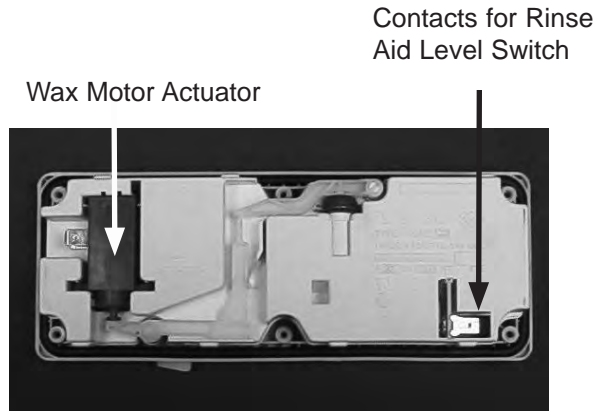

FIGURE 18

Checking the Dispenser

An operational check of the dispenser can be done using the Component Function Test.

- The service test is covered in section "Component Function Test".

IF THE DISPENSER DOES NOT OPEN

1. Disconnect dishwasher from power supply.
2. Remove outer door panel.
 - The wax motor normal resistance is 1665.
3. Check rinse agent indicator switch.
 - An empty dispenser will have a resistance reading of 0 ohms.
 - A dispenser with rinse agent will have an open resistance reading.



FIGURE 19

Fan Dry Unit

Dishes are dried with a fan driven condensate system. This system is made up of (refer to Figures 20, 21):

1. Fan Dry Motor
2. Air Intake
3. Condensate Duct
4. Condensate Vent

As the dishwasher completes its final drain, the fan dry motor forces saturated air across cool baffles in the condensate duct, resulting in the removal of moisture from the air. The cooler, drier air and condensed water are returned to the tub through the condensate vent. The drying process continues until moisture is removed from the air left in the tub, thus allowing the hot dishes to completely dry.

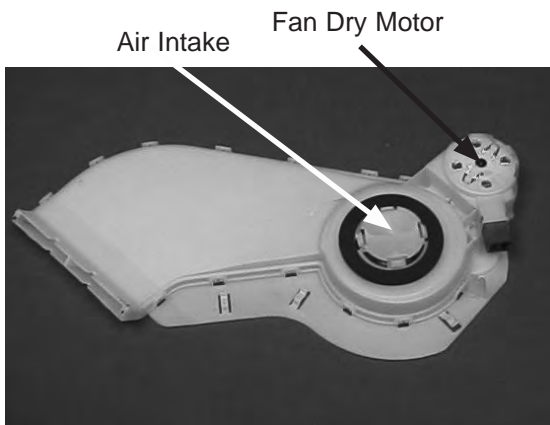

FIGURE 20

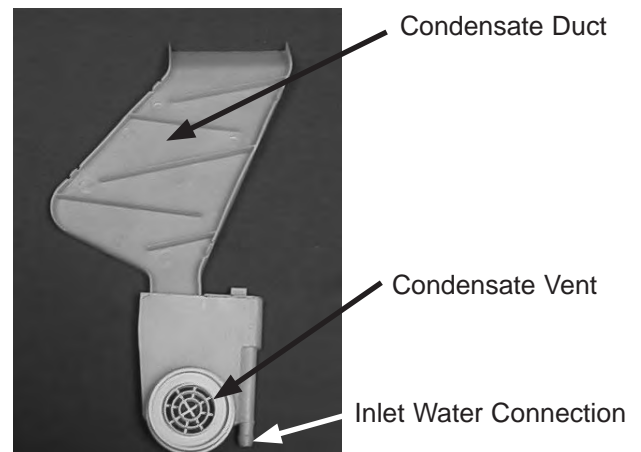

FIGURE 21

Checking Fan Dry Motor

1. Disconnect dishwasher from power supply.
2. Fan dry motor can be checked at the control panel between P3-3 blue and P3-8 white.
 - Normal resistance is 2088 ohms.

Section 4 - Service & Disassembly

Safety Precautions

Always turn off the electric power supply before servicing electrical components, testing with an ohmmeter, or replacing parts. Refer to Safe Servicing Procedures at the front of this manual before servicing the dishwasher.

All voltage checks should be made with a voltmeter having a full scale range of 130 volts or higher.

After service is completed, be sure all safety-grounding circuits are complete, all electrical connections are secure, and all access panels are in place.

If the repair on this product requires the removal of door panel, liner, or the cabinet, you may find exposed sharp edges. **Removing the door could expose sharp edges - use extreme caution.** Care must be taken to avoid injury while working with exposed sharp edges. It is highly recommended that protective clothing and gloves are worn while performing service to this product.

Door Panel

In order to access the electronic controls, the outer door panel must be removed from the door assembly.

1. Disconnect dishwasher from power supply.
2. The outer door panel is mounted to the inner door panel by Phillips head screws (Figure 22).
3. Removing the outer door panel will expose sharp edges on the inner door panel.
4. Be sure to support outer door as screws are removed to prevent damage to outer panel and dishwasher.
5. Remove wiring harness from control and ground connection on door panel.
6. The outer door panel is disconnected.



FIGURE 22

Control

1. Disconnect dishwasher from power supply.
2. Remove outer door panel (see Service and Disassembly section labeled Door Panel).
3. Lay outer door panel face down on a protective surface.
4. Compress plastic retainers with a pair of pliers to release the electronic control from carrier panel (Figure 23).
5. Lift control from mount.
6. With the control removed, pull protective shield back to free ribbon from keypad assembly.
7. Remove two screws holding outer door reinforcement to outer door panel.
8. These screws also hold the door handle in place.
9. Do not drop door handle.
10. Remove this reinforcement to gain access to keypad assembly.
11. To install parts, reverse procedure.

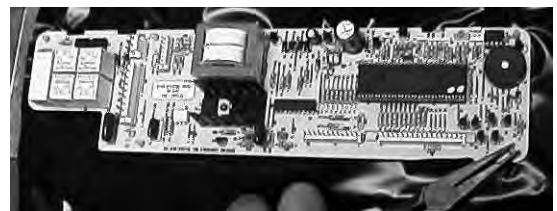

PLIERS ON MOUNT – FIGURE 23

Dispenser

1. Disconnect dishwasher from power supply.
2. Remove outer door panel (see previous section for detailed instructions).
3. Remove six screws securing dispenser assembly to inner door panel. Retainer brackets on the top and bottom may also need to be removed.

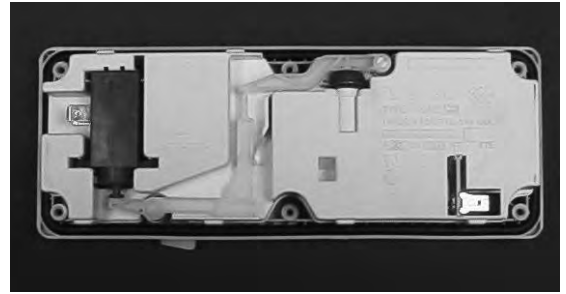

FIGURE 24

Lower Access Panel

1. Remove bottom kick plate.
2. Remove screws on each side of lower access panel. (See Figure 25)
3. Remove access panel.

EDGES ARE SHARP - USE EXTREME CAUTION

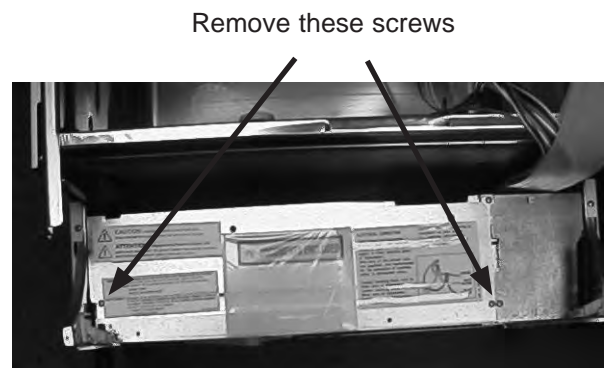

FIGURE 25

Door Latch/Door Switch

1. Remove outer door panel. (See previous section for detailed instructions.)
2. Remove two screws mounting the latch/switch assembly to inner door panel, and then remove two wires.
3. Reinstall wires to door latch/switch assembly and remount assembly to inner door panel.
4. Close door to make sure strike catches latch cam to close door switch.
5. If door strike needs to be adjusted, loosen retaining screw in top of tub. This allows strike to be moved as needed. Tighten retaining screw after adjustment is made.



FIGURE 26



Latch cam in open position

FIGURE 27

Upper Spray Arm

1. The center of the upper spray arm is a locking mount.
2. Turn upper spray arm and mount counterclockwise to remove. (See Figure 28)
3. To reinstall upper spray arm, line up locking posts in center mount with locking tabs on upper spray arm support. Turn clockwise until it locks securely.

Turn center of spray arm to remove



FIGURE 28

Lower Spray Arm

1. Remove lower rack.
2. Lower spray arm snaps onto volute cover.
3. Lift arm to remove.

All 3 dishwasher spray arms



FIGURE 29

Center Spray Arm and Upper Rack Manifold

1. Remove upper rack and place rack upside down on a flat surface.
2. Place blade of a very thin putty knife between retaining ring and center spray arm. Lightly twist knife to lift arm from retaining ring. (See Figure 30)
3. Remove manifold from rack by compressing tube retainer clips and sliding tube backwards to clear front mount. Reverse this procedure to reattach manifold.
4. To reinstall arm, place both halves of retaining ring onto manifold. Place center spray arm over retaining clips and press into place.
5. After replacing rack in tub, reinstall rail end caps.

Putty knife between spray arm and retaining ring



FIGURE 30

Center rack manifold with retaining ring and center spray arm



FIGURE 31

Main Delivery Tube

1. To gain access to main delivery tube, cabinet will need to be removed. See section on **CABINET REMOVAL** for detailed instructions.
2. Place dishwasher on its back. Loosen and remove clamp-holding tube from inline heater.
3. Set dishwasher upright to remove nozzle from rear inside of tub. This unscrews counterclockwise.
4. Remove tube from tub.
5. Reverse procedure to reinstall. Be sure to check gasket on upper end of tube before tube end is placed into tub.

Upper Spray Arm Mount

1. Replacing upper spray arm mount requires removal of cabinet. See section on cabinet removal for detailed instructions.
2. Set dishwasher upright and remove upper spray arm. The mount pushes into the top of the tub with a rubber grommet. An arm on the mount holds it in place to prevent turning during removal/ installation of the upper spray arm.
3. Reverse procedure for reassembly.

Bottom Door Seal

1. The bottom door seal is mounted to the bottom of the inner door panel by five screws. Remove lower rack and screws to remove seal.
2. Do not over-tighten screws when reinstalling.



FIGURE 32

Door Seal

1. While door is open, remove seal from seal mount on both sides and across top of tub.
2. To reinstall, begin inserting seal at either the left or right side. Place seal into channel with wide side towards inside of tub. (See Figure 33)
3. Run seal up the channel, making sure seal is as deep in channel as possible.
4. Do not stretch seal around corners, as leakage may occur as a result.
5. The door seal is precut to the proper length and should not be cut.
6. Once seal is properly in place, make sure seal is completely in channel. Using a wide blade putty knife may help to push seal in place.
7. Close door to make sure door seals. The door catch may need adjusting. See the section on door latch/switch adjustment page 3-7 for detailed instructions.

Part of seal to inside of tub



DOOR SEAL – FIGURE 33

Water Valve

1. Disconnect dishwasher from power supply.
2. Turn off water supply to dishwasher.
3. Remove kick plate and lower access panel. Removal of outer door panel may be needed to gain access to necessary parts.
4. Remove wire connect and water supply line.
5. Remove two mounting screws holding water valve to front frame.
6. To remove fill hose from valve, rotate water valve. Then remove valve.
7. Reverse procedure to reinstall.

CABINET REMOVAL

1. Disconnect power supply and water supply.
2. Remove drain hose from drain line.
3. Slide dishwasher from under countertop to gain access to cabinet.
4. Remove four screws mounting top trim to tub. Also remove screws on each side that secure lower trims to cabinet.
5. Remove screws from front flange of cabinet that attach it to tub. (See Figure 34)
6. From rear of cabinet, remove screws that attach it to rear frame. (See Figure 36)
7. Lay dishwasher on its back on a protective pad. Remove screws that attach the cabinet to bottom of frame. (See Figure 35)
8. Open sides of cabinet and slide cabinet away from tub.



CAUTION

Edges are sharp. Protect yourself and be careful not to damage the insulation blanket around the tub.



FRONT OF CABINET
- FIGURE 34



BOTTOM OF DISHWASHER
- FIGURE 35



BACK OF CABINET
- FIGURE 36

Door Spring

1. Remove dishwasher cabinet. See previous section detailed instructions.
2. Raise spring support rod out of mounting hole of "C" arm. (See Figure 38)
3. Reinstall door spring using reverse procedure.

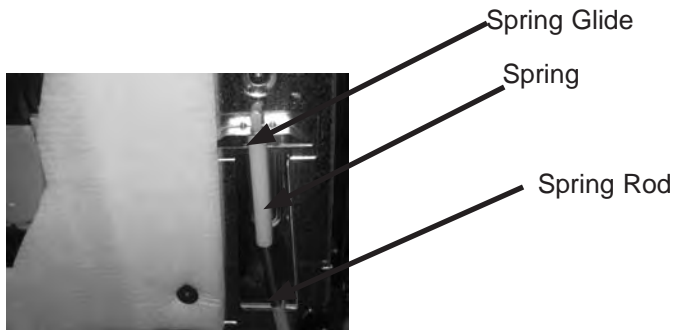

FIGURE 37

End of spring rod goes into hinge

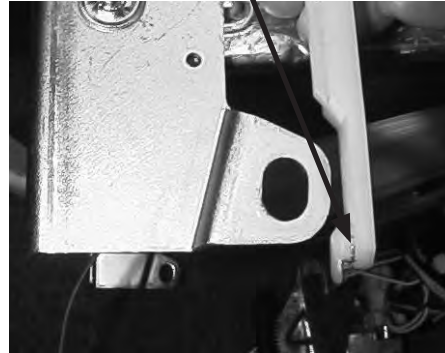

FIGURE 38

Hinge "C" Arm

1. Remove dishwasher cabinet. See **CABINET REMOVAL** for detailed instructions.
2. Remove door spring. See previous section for detailed instructions.
3. Remove two screws that attach inner door panel to hinge.
4. Remove hinge retainer from hinge pin. Then remove hinge. (See Figure 39)
5. Replace hinge and install a new hinge retainer.
6. Reverse order procedure to complete assembly.

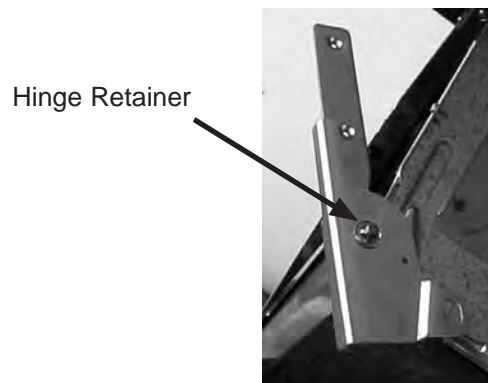

FIGURE 39

Door Seal Retainer

1. Remove dishwasher cabinet. See **Cabinet Removal** for detailed instructions.
2. Place dishwasher in an upright position and remove door seal. See previous section for detailed directions.
3. Remove screws (across the top and on both sides of the unit) that mount door seal retainer to tub.
4. Make sure the retainer gasket is in place and not torn before reinstalling the retainer.
5. Reverse order to complete assembly.

Pressure Switch Assembly

1. Remove dishwasher cabinet. See **CABINET REMOVAL** for detailed instructions.
2. Remove hoses and electrical connections to switches. (See Figure 40)
3. Remove screw that mounts assembly to side frame. (See Figure 41)
4. Reverse procedure for reinstallation.

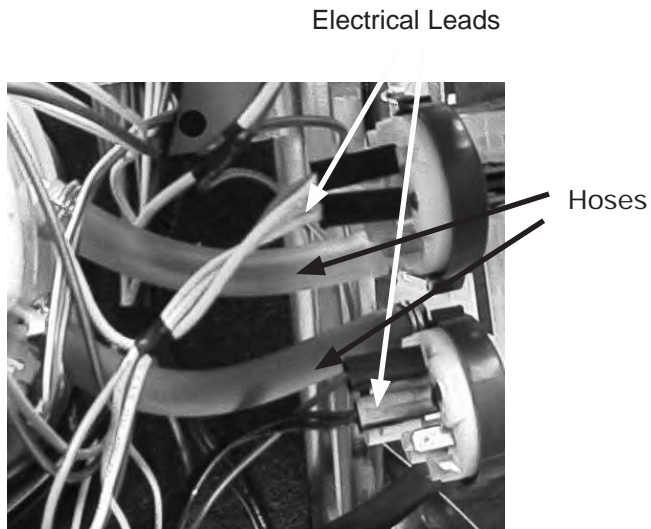

FIGURE 40



FIGURE 41

DACOR BUILT-IN DISHWASHER SERVICE MANUAL

Thermistor/Soil Sensor

1. Disconnect dishwasher from power and water supplies. Remove drain line.
2. Remove dishwasher from countertop.
3. Lay dishwasher on its back on a protective pad.
4. Remove wire plug from sensor by lifting lock to release plug.
5. Push retainers away from sensor and remove sensor from sump. (See Figure 42)
6. To reinstall, apply lubricant to sensor seal. Line up location tab with appropriate slot in sump and lock in place.
7. Complete installation by reversing procedure.

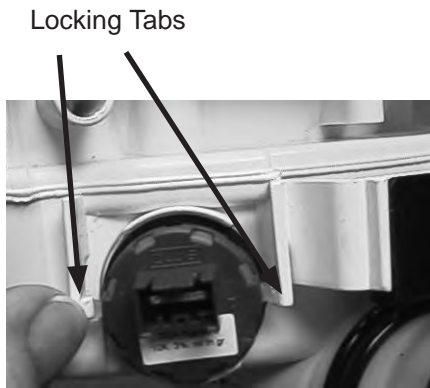
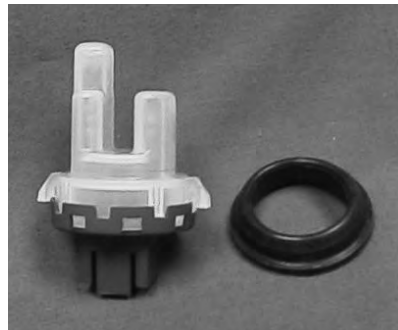

FIGURE 42



SENSOR & SEAL
- FIGURE 43

Bottom of leg with reinforcement rod



FIGURE 44

Inline Heater

1. Disconnect dishwasher from power and water supplies. Remove drain line.
2. Remove dishwasher from counter top.
3. Lay dishwasher on its back on a protective pad.
4. Disconnect wires from heater.
5. Slide clamps from heater and remove hoses.
6. Reinstall by reversing the procedure. Apply lubricant to the hose for easier reinstallation of the hose clamps.

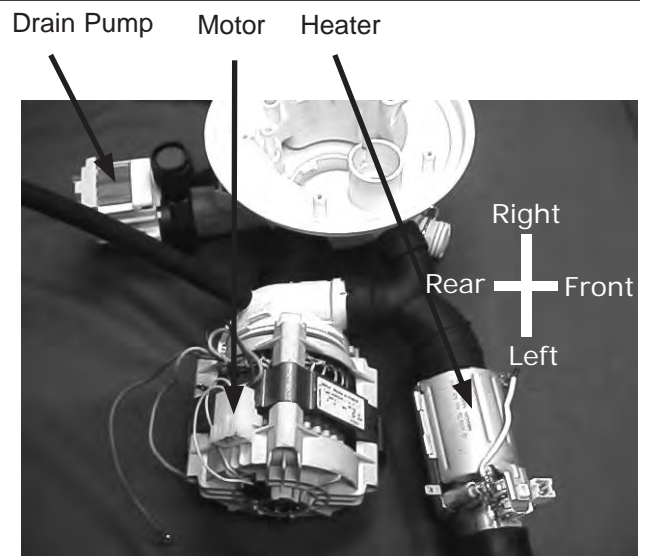

WATER SYSTEM WITH TUB REMOVED
- FIGURE 45

Drain Pump

1. Disconnect dishwasher from power and water supplies. Remove drain line.
2. Remove dishwasher from countertop.
3. Lay dishwasher on its back on a protective pad.
4. Remove wires from drain pump.
5. Removing coupling hose with drain pump aids in pump removal from sump.
6. The locks holding the pump to the sump are located on both ends of the sump mount. Using a small blade screwdriver, push up on the locks, to release the pump. (See Figure 46)
7. Remove coupling hose from drain pump.
8. Reinstall in reverse order. Apply lubricant to the hose clamps for easier installation.

Push up on lock to release
drain pump from mount



**MOUNT ON BACK OF THE
SUMP – FIGURE 46**

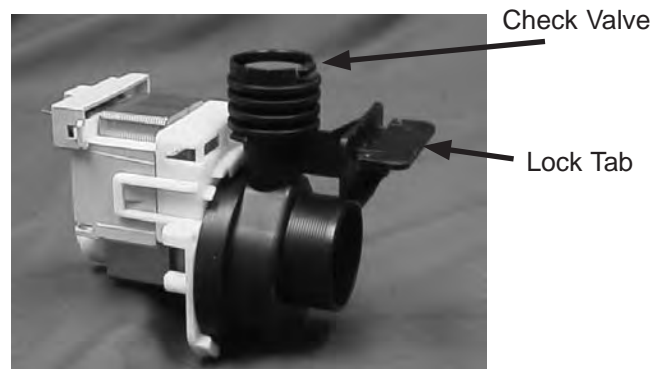

FIGURE 47

Wash Motor (See Figure 45)

1. Disconnect dishwasher from power and water supplies. Remove drain line.
2. Remove dishwasher from countertop.
3. Lay dishwasher on its back on a protective pad.
4. Slide hose clamps on the "Y" hose toward heater. Leave intake hose attached to motor.
5. To release motor mount (both front and rear), use blade of a small screwdriver to pry between motor mount and motor mounting bracket. (See Figures 48 and 49)
6. To remove wire plug, place blade of a small screwdriver between disconnect and motor terminal block to release lock. (See Figure 50 for location of lock)
7. Remove two wires connecting motor capacitor.
8. Remove hose from motor intake.
9. Reinstall in reverse order. Apply lubricant to hose clamps for easier installation.

Wash Motor (continued)



FRONT MOUNT – FIGURE 48



REAR MOUNT – FIGURE 49

Capacitor

1. Disconnect dishwasher from power and water supplies. Remove drain line.
2. Remove dishwasher from countertop.
3. Lay dishwasher on its back on a protective pad.
4. Capacitor is mounted to back frame of the unit using a mounting nut.
5. Remove cap and wires.
6. Reinstall using reverse procedure.



**LOCK FOR DISCONNECT
– FIGURE 50**



**MOTOR RUNNING
CAPACITOR – FIGURE 51**



FIGURE 52

Blower Assembly

1. Remove dishwasher cabinet. See **CABINET REMOVAL** for detailed instructions.
2. After cabinet is removed, set unit upright.
3. From inside of the tub, depress retaining clips. (See Figure 54) Blower assembly is removed from top outside of tub.
4. Remove blower from side duct and remove wires from blower motor.
5. Reverse procedure to reinstall.

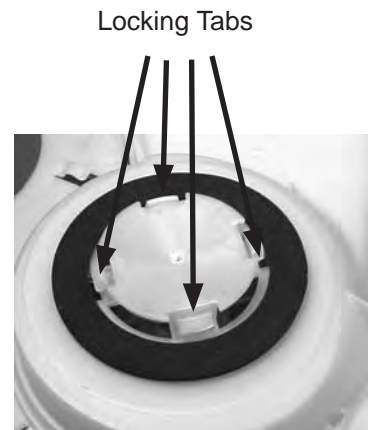

FIGURE 54

Sump

1. Disconnect dishwasher from power and water supplies. Remove drain line.
2. Remove lower spray arm, filters, and volute cover from inside of tub. Remove four screws mounting sump to tub.
3. Remove dishwasher from underneath countertop.
4. Lay dishwasher on its back on a protective pad.
5. Remove wires to sensor.
6. Remove hoses from sump. (pressure switches, wash motor intake, lower spray arm)
7. The drain pump may be removed with the sump for convenience.
8. Remove sump from tub. Then remove drain pump, sensor, and sump gasket from sump. (If replacing the sump, these parts may be installed on the new sump.)
9. Reassemble by mounting sump to tub and securing screws into sump from inside tub. (This will hold the sump in place.)
10. Reinstall hoses and reposition hose clamps.
11. Reinstall wire plug to sensor.
12. Finish reassembly by installing cabinet and remaining parts inside tub.
13. Recheck sump mounting screws by filling dishwasher with water and assessing for leaks.

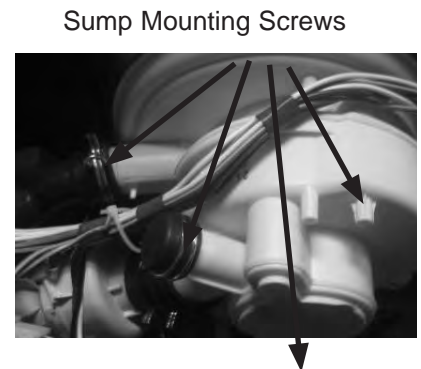

FIGURE 53

Side Vent and Fill Hose

1. Remove dishwasher cabinet. See **CABINET REMOVAL** for detailed instructions.
2. With cabinet removed, set unit upright.
3. Remove fill hose from side vent by removing hose clamp.
4. Unscrew (counterclockwise) vent grate from left side wall inside tub.
5. Remove side vent.
6. Reverse procedure to reinstall.

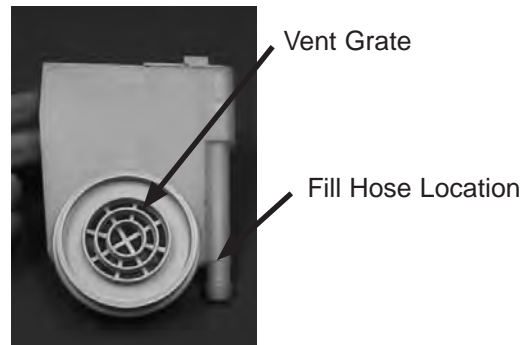

FIGURE 55

SECTION 5 - TROUBLESHOOTING TIPS

SYMPTOM	CHECK THE FOLLOWING	REMEDY
Dishwasher will not operate when turned on.	<ol style="list-style-type: none"> 1. Fuse (blown or tripped). 2. 120 VAC supply wiring connection faulty. 3. Electronic control board faulty. 4. Motor (inoperative, check resistances). 5. Door switch (open contacts). 6. Door latch not making contact with door switch. 7. Touch pad circuit defective. 8. No indicator lamps illuminate when START or OPTIONS is depressed. 	<ol style="list-style-type: none"> 1. Replace fuse or reset breaker. 2. Repair or replace wire fasteners at dishwasher junction box. 3. Replace control board. 4. Replace motor/impeller assembly. 5. Replace door switch. 6. Replace latch assembly. 7. Replace keypad. 8. Replace keypad.
Motor hums but will not start or run.	<ol style="list-style-type: none"> 1. Motor (bad bearings or locked rotor). 2. Motor locked due to prolonged non-use. 	<ol style="list-style-type: none"> 1. Replace motor. 2. Rotate motor fan or impeller.
Motor trips out on internal thermal overload protection.	<ol style="list-style-type: none"> 1. Improper voltage. 2. Seal faces binding. 3. Motor windings shorted. 4. Glass or foreign items in pulp. 	<ol style="list-style-type: none"> 1. Check voltage. 2. Rotate motor fan or impeller, or replace. 3. Replace motor/pump assembly. 4. Clean and clear blockage.
Dishwasher runs but will not heat.	<ol style="list-style-type: none"> 1. Heater element open. 2. Electronic control board defective. 3. Wiring or terminal defective. 	<ol style="list-style-type: none"> 1. Replace heater element. 2. Replace control board. 3. Repair or replace.
Detergent cover will not latch or open.	<ol style="list-style-type: none"> 1. Excess detergent on lid catch. 2. Latch mechanism defective. 3. Electronic control board defective. 4. Wiring or terminal defective. 5. Broken spring(s). 6. Defective actuator. 	<ol style="list-style-type: none"> 1. Clean catch area. 2. Replace dispenser. 3. Replace control board. 4. Repair or replace. 5. Replace dispenser. 6. Replace actuator.

DACOR BUILT-IN DISHWASHER SERVICE MANUAL

SYMPTOM	CHECK THE FOLLOWING	REMEDY
Dishwasher will not pump out.	<ol style="list-style-type: none"> 1. Drain restricted. 2. Defective drain pump. 3. Air lock in drain hose. 4. Blocked impeller. 5. Open windings. 6. Wiring or terminal defective. 7. Electronic control board defective. 	<ol style="list-style-type: none"> 1. Clear restrictions. 2. Replace pump 3. Check dishwasher installation. 4. Check for blockage and clear. 5. Replace windings. 6. Repair or replace. 7. Replace control board.
Dishwasher will not fill with water.	<ol style="list-style-type: none"> 1. Water supply turned off. 2. Defective water inlet valve. 3. Check fill valve screen for obstructions. 4. Defective pressure switch. 5. Electronic control board defective. 6. Wiring or terminal defective. 	<ol style="list-style-type: none"> 1. Turn water supply off. 2. Replace water inlet fill valve. 3. Disassemble and clean screen. 4. Repair or replace. 5. Check/replace control board. 6. Repair or replace.
Dishwasher water siphons out.	<ol style="list-style-type: none"> 1. Drain line connected to a floor drain not vented. 	<ol style="list-style-type: none"> 1. Install air gap at counter top.
Detergent left in dispenser.	<ol style="list-style-type: none"> 1. Detergent allowed to stand too long in dispenser. 2. Dispenser wet when detergent was added. 3. Detergent cover held closed or blocked by large dishes. 4. Improper incoming water temperature to properly dissolve detergent. 5. See "Detergent Cover Will Not Open". 	<ol style="list-style-type: none"> 1. Instruct customer/user. 2. Instruct customer/user. 3. Instruct customer/user on proper loading of dishes. 4. Incoming water temperature of 120°F is required to properly dissolve dishwashing detergent.

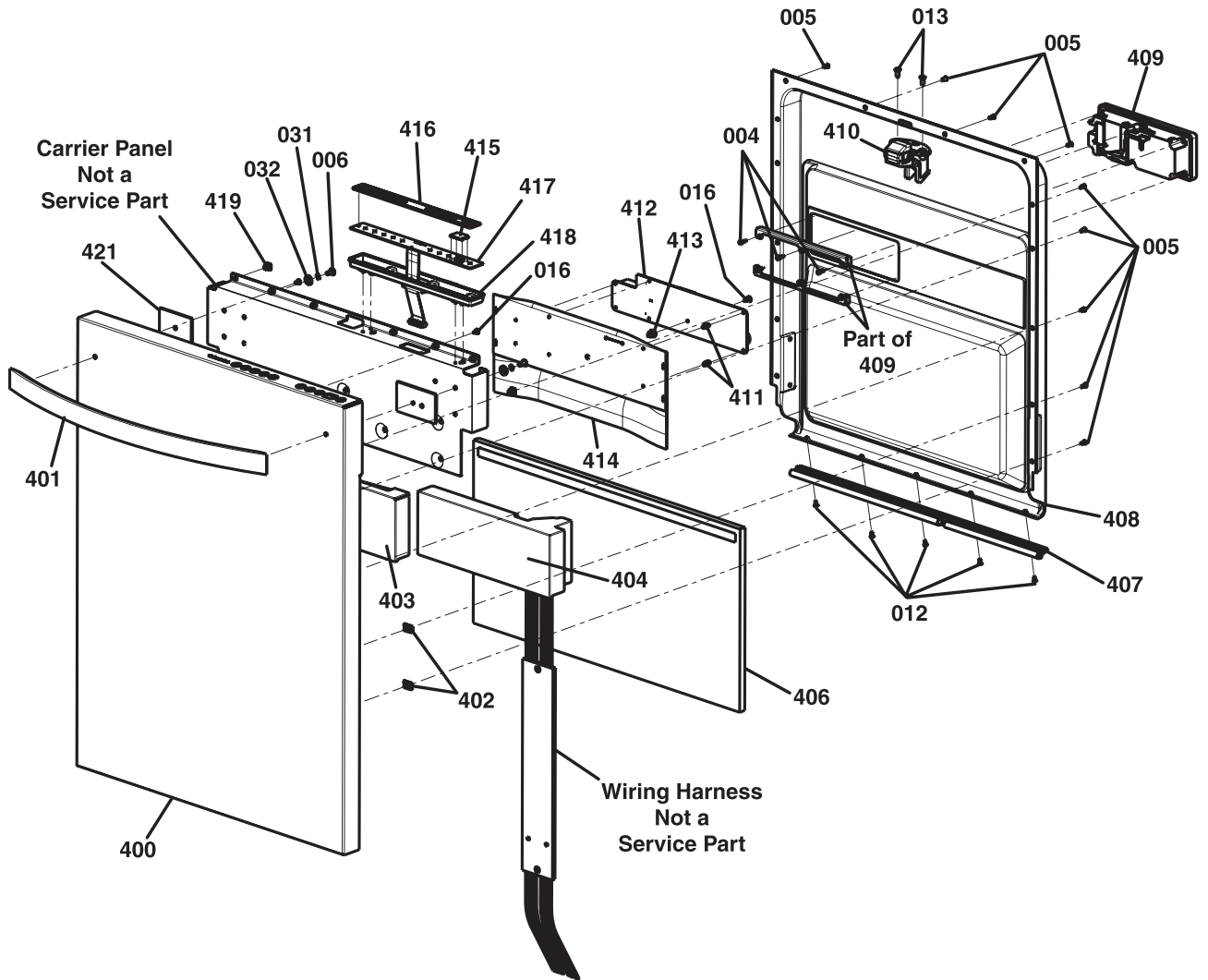

DOOR AND CONTROL PANEL