

FOR MODELS:

SHI

4302 4306
6802 6805
6806

SHU 3032 3035
3036

3302 3305
3306 3322
3326 3336

4302 4306
4312 4316
4322 4326
5302 5304
5305 5306
5307 5312
5314 5315
5316 5317
6802 6805
6806

9902 9905
9906 9912
9915 9916
9922 9925
9926

SHV

4303 4803

B/S/H/

**SHU/SHI/SHV Dishwasher
Troubleshooting Tips**

For: BOSCH

Effective May 18, 2001

1st Edition/Rev. 2

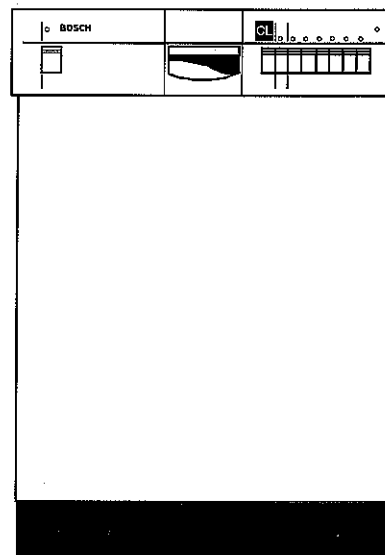

BSH Home Appliances
5551 McFadden Avenue
Huntington Beach, California 92649



TABLE OF CONTENTS

Measuring resistances from the front of SHU/SHI 43/53/68 dishwashers.....	A-1
Measuring resistances from the front of SHU 99 & SHV 43/48 dishwashers..	A-2
Measuring resistances from the front of SHU 33 dishwashers.....	A-3
Measuring resistances from the front of SHU 303x dishwashers.....	A-4
Installing jumper for control modules for SHU 53x dishwashers.....	A-5
Using the test program to troubleshoot the heater, flow switch and Hi-Limit thermostat from the front of SHI/U 43/53/68 dishwashers.....	B-1
Key parts changes for SHU/SHV/SHI UC/11 dishwashers for softer bearing..	B-2
Using front cover to replace SHU 43/53/68 control module buttons.....	B-3
Soldering SHU 43/53/68 control module heater relays.....	B-4
SHU Dishwasher Quick Check Chart.....	C-1
SHU Dishwasher Troubleshooting Chart.....	D-1
SHU 43/53/68 Schematic Diagram #36 (reprinted from Tech Manual).....	E-1
SHV 43/48 Schematic Diagram #48 (reprinted from Tech Manual).....	E-2
SHU 43/53/68 Dishwasher Test Programs.....	F-1
SHV 43/48 Dishwasher Test Program.....	F-2
SHU 99 Dishwasher Test Programs.....	F-3
SHU 33 Dishwasher Test Program.....	F-4
Using Dishwasher Serial Number to find Date of Manufacture.....	G-1
Dishwasher Notes.....	H-1

Measuring resistances from the front of SHU/SHI 43/53/68 dishwashers

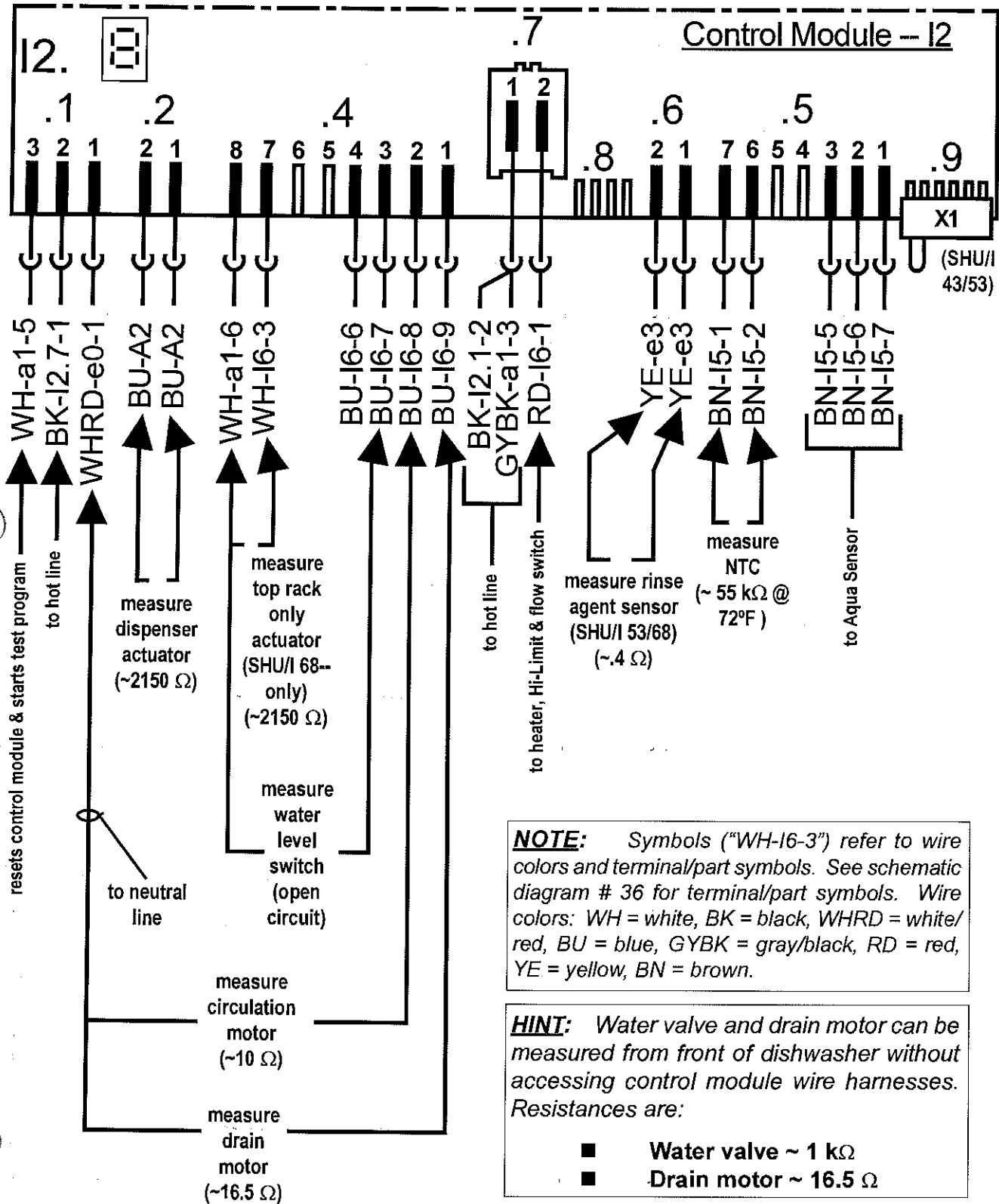

Measuring resistances from the front of SHU 99 & SHV 43/48 dishwashers

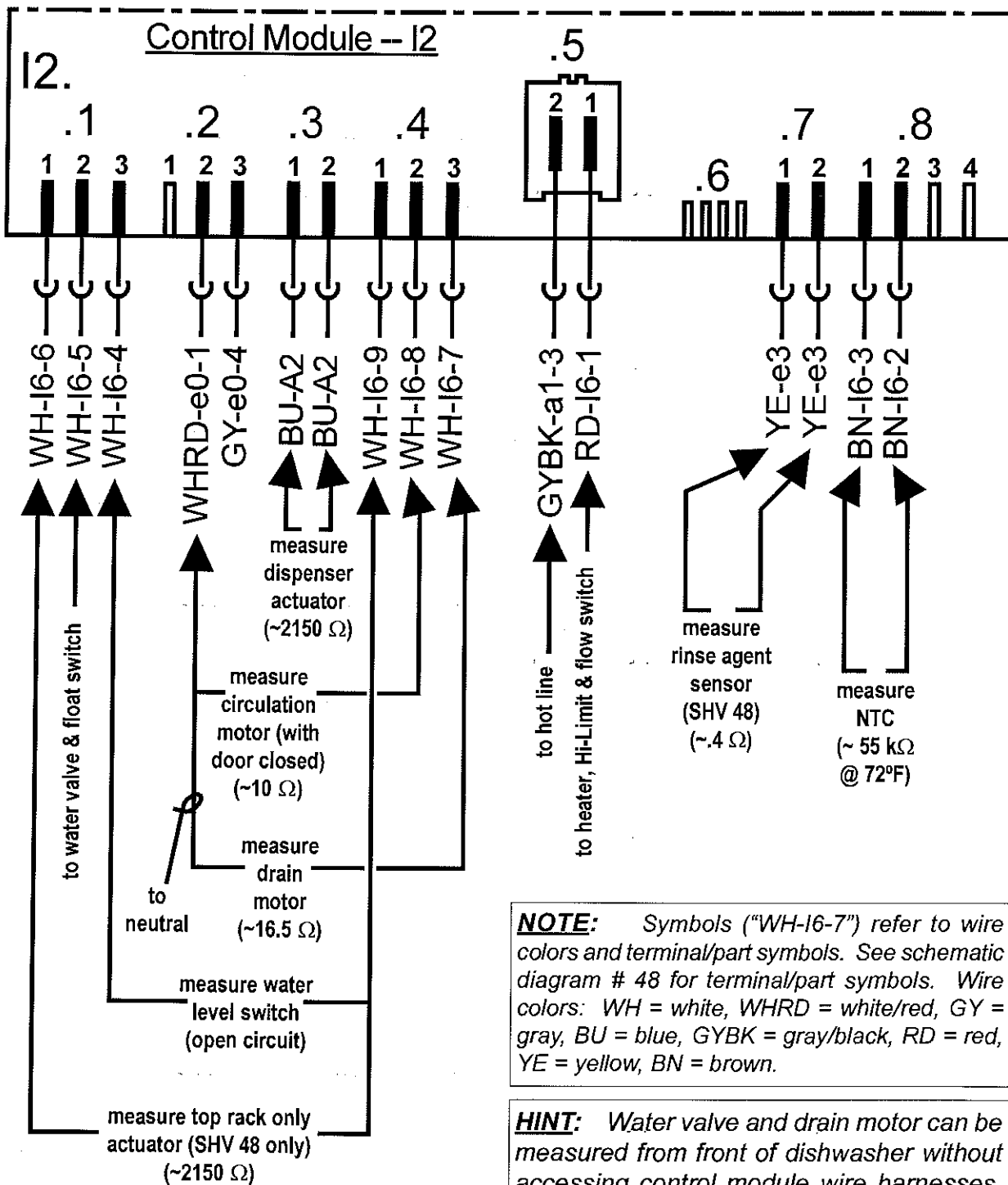

NOTE: Symbols ("WH-I6-7") refer to wire colors and terminal/part symbols. See schematic diagram # 48 for terminal/part symbols. Wire colors: WH = white, WHRD = white/red, GY = gray, BU = blue, GYBK = gray/black, RD = red, YE = yellow, BN = brown.

HINT: Water valve and drain motor can be measured from front of dishwasher without accessing control module wire harnesses. Resistances are:

- Water valve ~ 1 kΩ
- Drain motor ~ 16.5 Ω

Measuring resistances from the front of SHU 33 dishwashers

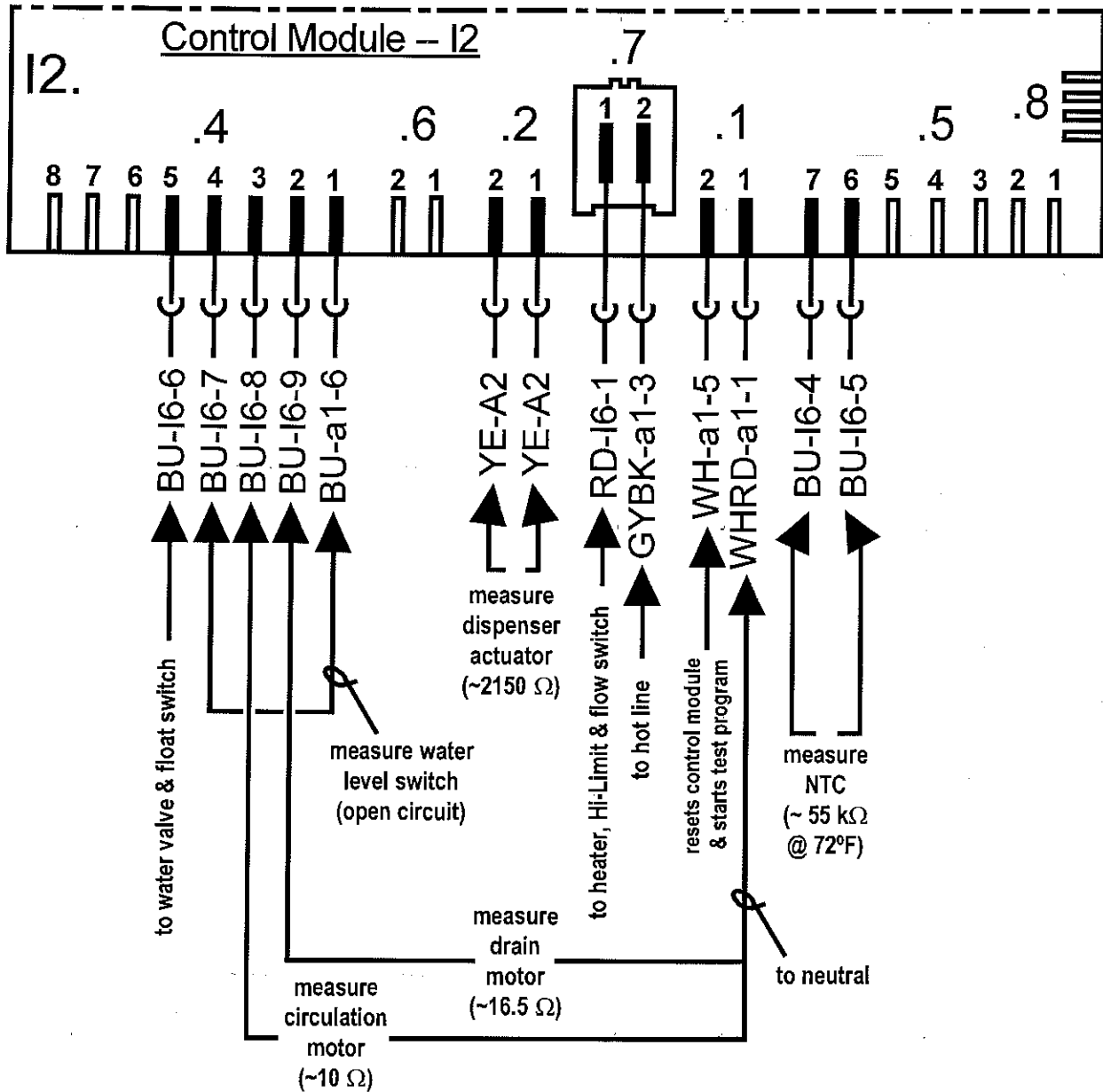

NOTE: Symbols ("WH-a1-5") refer to wire colors and terminal/part symbols. See schematic diagram # 60 for terminal/part symbols. Wire colors: WH = white, WHRD = white/red, BU = blue, GYBK = gray/black, RD = red, YE = yellow.

HINT: Water valve and drain motor can be measured from front of dishwasher without accessing control module wire harnesses. Resistances are:

- Water valve ~ 1 kΩ
- Drain motor ~ 16.5 Ω

Measuring resistances from the front of SHU 303x dishwashers

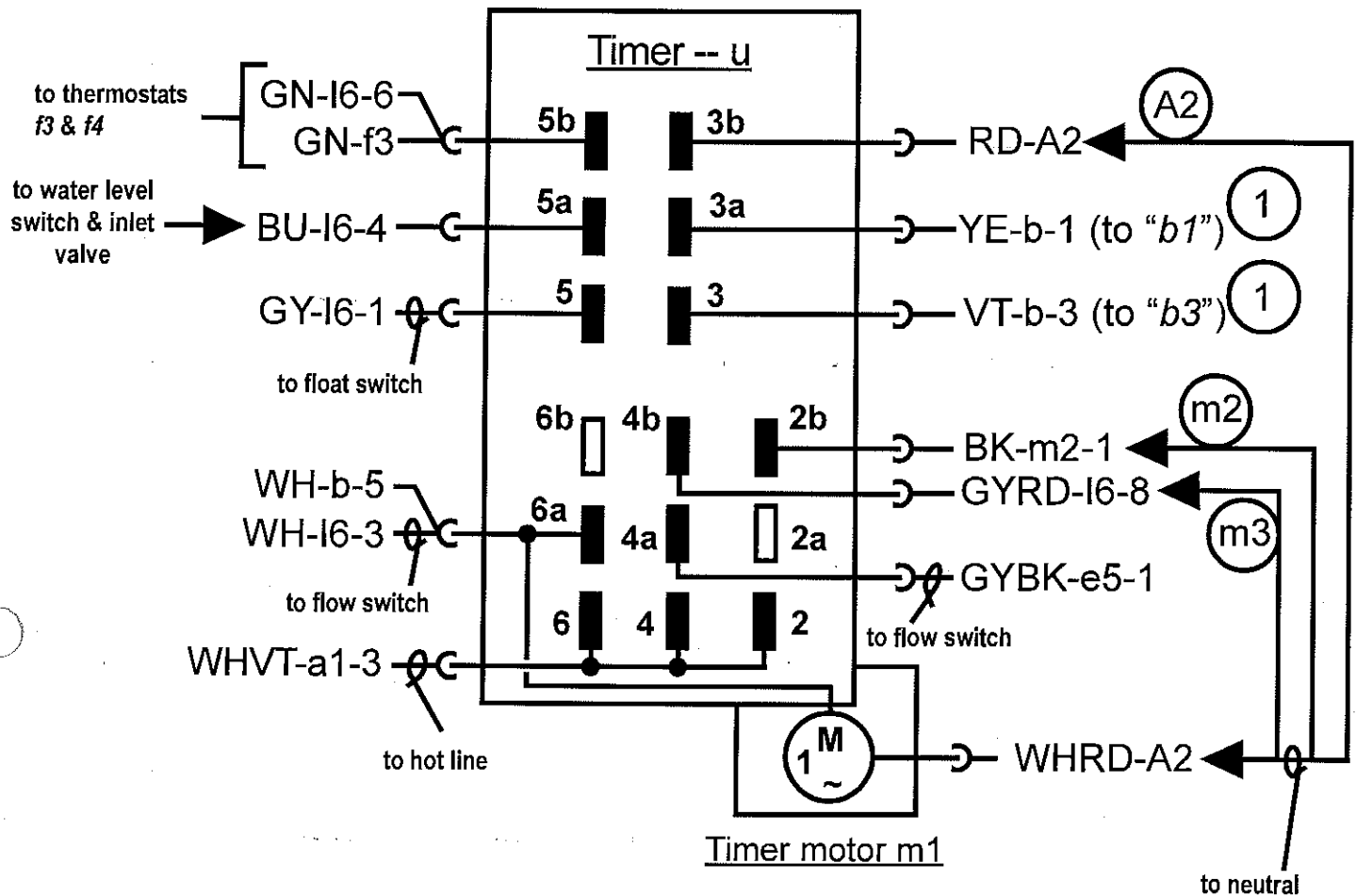

- | | | | |
|--|--|---|---|
| (m2) | (m3) | (A2) | (1) |
| measure
circulation
motor
(~10 Ω) | measure
drain
motor
(~16.5 Ω) | measure
detergent
actuator
(~2150 Ω) | see circuit /
schematic
diagram # 62
for b1 & b3 |

NOTE: Symbols ("WH-I6-3") refer to wire colors and terminal/part symbols. See schematic diagram # 62 for terminal/part symbols. Wire colors: WH = white, WHRD = white/red, WHVT = white/violet, BU = blue, GYBK = gray/black, BK = black, GYRD = gray/red, GY = gray, GN = green, RD = red, VT = violet, YE = yellow.

HINT: Water valve and drain motor can be measured from front of dishwasher without accessing timer wire harnesses. Resistances are:

- Water valve ~ 1 kΩ
- Drain motor ~ 16.5 Ω

Installing jumper for control modules for SHU/I 53 series dishwashers

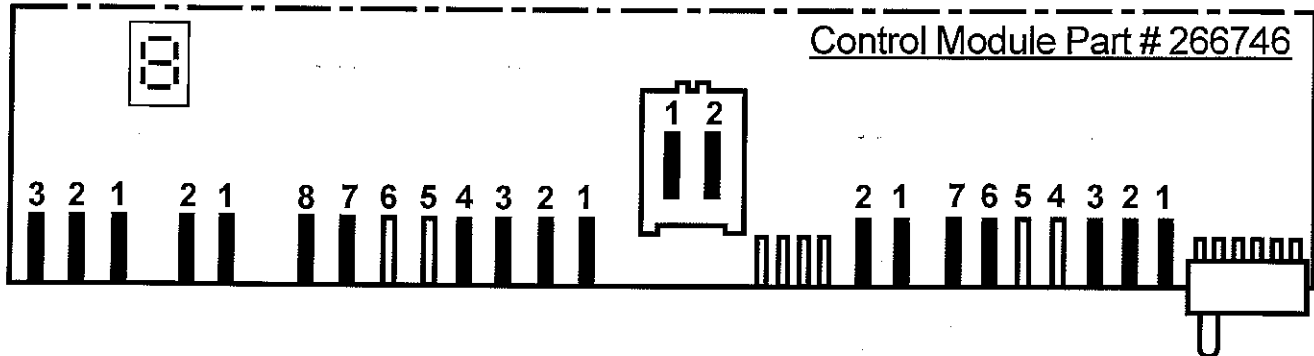

NOTE: Remove existing jumper from old SHU/I 53 control module and install onto new module.

*This part # 266746 control module is used for all SHU/I 53 series & SHU/I 68 series dishwashers. SHU/I 53 models use a jumper (part # 167782), while SHU/I 68 models don't. Since each control module is shipped **without** a jumper, existing jumper must be used.*

This applies to SHU/I 5302, 5304, 5305, 5306, 5307, 5312, 5314, 5315, 5316 & 5317 models.

Using the test program to troubleshoot the heater, flow switch and Hi-Limit thermostat from the front of SHU/I 43/53/68 dishwashers

TEST	TIME	NOTES
Entering test program	----	Press <i>On/Off</i> button at the <u>same time</u> you press both the <i>Power Scrub Plus & Regular Wash</i> buttons (SHU/I 43 models) or the <i>Scrub Wash & Delicate/Econo</i> buttons (SHU/I 53 & 68 models). Indicating lights will flash.
Starting test program	----	Press both the <i>Power Scrub Plus & Regular Wash</i> buttons (SHU/I 43 models) or the <i>Scrub Wash & Delicate/Econo</i> buttons (SHU/I 53 & 68 models) a 2nd time.
Skipping a test	----	Press <i>Scrub Wash</i> button (SHU/I 43 models) or <i>Regular Wash</i> button (SHU/I 53 & 68 models).
Draining	30 seconds	Allow dishwasher to drain.
Aqua Sensor calibration	65 seconds	Not on SHU/I 43 models. <u>Skip this test.</u>
Filling	Until water level switch closes	Can't skip this test
Heating & Circulating	Until water reaches 150°F (rises ~ 2°F/minute)	Don't run entire test (to save time) -- when water starts circulating, measure current in main power line to dishwasher. Skip test once current has been measured. If current is ~ 11A, heater, flow switch and Hi-Limit are OK. If current ~ 1.5-2A, turn off dishwasher, remove or block up tank and measure resistance of heater, Hi-Limit & flow switch (see below).
Draining	60 seconds	Last test. To end test program, press <i>On/Off</i> button (all models).

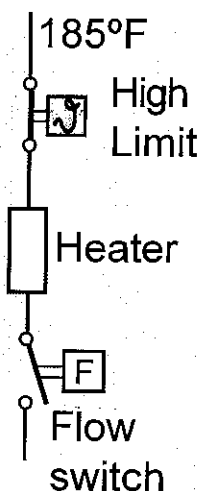

NOTE: Once its found one of these parts is faulty (from incoming current being 1.5 - 2A), check each part (once tank has been removed or blocked up) by measuring its resistance at its terminals:

- Heater ~ 11 Ω
- Hi-Limit ~ .3 Ω
- Flow switch ~ .4 Ω — must remove microswitch from heater housing & close its contacts to measure this. A spring loaded plunger closes microswitch when water is flowing.

Key functional parts changes for SHU/SHV/SHI dishwashers for "softer bearing" index UC/11

Key SHU/SHV/SHI dishwasher parts have been changed for the "softer bearing" upgrade for index # UC/11 for all models. This made the dishwashers quieter through suspending the circulation pump by flexible bands instead of mounting it onto the base. The key parts changes are shown below, including part #'s and model #'s parts are used on. *Please note these changes to order the correct parts for each dishwasher model/index #. All other component assembly parts and part #'s (drain pump, circulation pump impeller, circulation pump motor capacitor, water inlet valve, NTC, base, etc.) are the same as before.*

Part description	Old part #	Models used on	New part #	Models used on
Circulation pump	263835	All models (index #'s UC/06 & UC/10, except SHV 43/48 UC/10)	266511	All models (index #'s UC/07, UC/11 & UC/12)
Heater assembly (for aqua sensor)	263869	SHU 53/68 (index #'s UC/06 & UC/10)	480317	SHU 43**/53/68 (index #'s UC/11 & UC/12)
Heater assembly (no aqua sensor)	264462	SHU/SHI 33/43*/99 (index #'s UC/06, & UC/10) & SHV 43/48 index # UC/06	480316	SHU/SHV/SHI 33/43*/48/99 (index #'s UC/07, UC/11 & UC/12)
Sump	263103	All models (index #'s UC/06 & UC/10, except SHV 43/48 UC/10)	266158	All models (index #'s UC/07, UC/11 & UC/12)
Pump support bushings ↓	167244	All models (index #'s UC/06 & UC/10, except SHV 43/48 UC/10)	-----	
Pump support straps	-----		171596	All models (index #'s UC/07, UC/11 & UC/12)
Gasket (pump to sump) ↓	165268	All models (index #'s UC/06 & UC/10, except SHV 43/48 UC/10)	-----	
Pipe clamp (pump to sump)	-----		172272	All models (index #'s UC/07, UC/11 & UC/12)
Pump rear housing	263314	All models (index #'s UC/06 & UC/10, except SHV 43/48 UC/10)	267739	All models (index #'s UC/07, UC/11 & UC/12)
Pump front housing	263838	All models (index #'s UC/06 & UC/10, except SHV 43/48 UC/10)	266514	All models (index #'s UC/07, UC/11 & UC/12)
Seal (pump to water inlet hose)	165269	All models (index #'s UC/06 & UC/10, except SHV 43/48 UC/10)	171598	All models (index #'s UC/07, UC/11 & UC/12)
Hose with O-ring (water inlet to pump)	298556	All models (index #'s UC/06, UC/07, UC/10 & UC/11)	361113	All models (index # UC/12)

* SHU 4302/4306/4312/4316 models (not including SHU 4322/4326 models with digital displays).

** SHU 4322/4326 models with digital displays.

CAUTION: Although the new base can be used interchangeably with new or old parts, the parts themselves cannot be used interchangeably. A new pump, sump or heater assembly must be replaced by new parts and cannot be used with the old pump, sump and heater assembly. Similarly, the old pump, sump or heater assembly must be replaced by old parts and cannot be used with the new pump, sump and heater assembly.

Using # 264946 Front Cover to Replace Broken # 266746, # 263832 or # 264461 Control Module Buttons

266746, # 263832 or # 264461 control modules are often replaced when buttons break, not for electronic failures. Replacing the # 264946 front cover when buttons break instead of replacing the entire control module will save customers time and money.

NOTE: The # 264946 front cover fits on all three modules - the # 266746, # 263832 and # 264461.

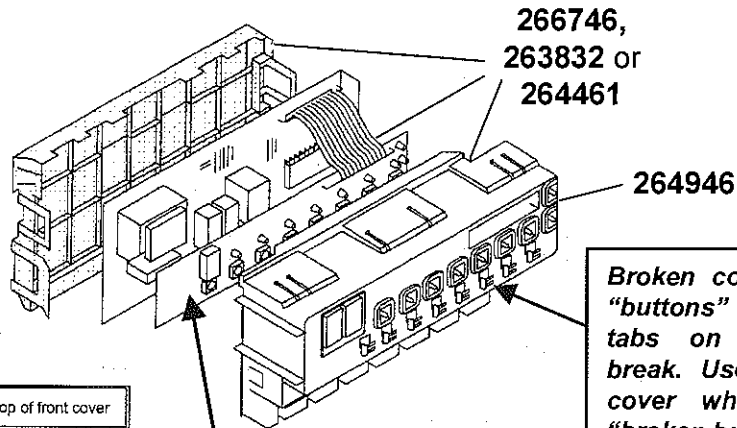

Broken control module "buttons" occur when tabs on front cover break. Use plastic front cover when replacing "broken buttons".

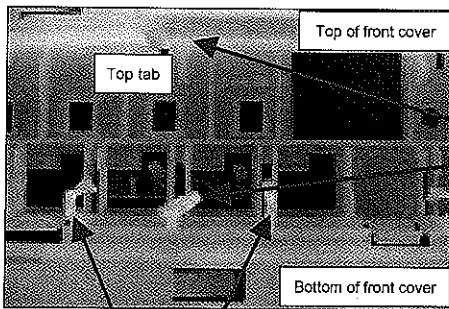

Note cracks in plastic locking tabs.

CAUTION: Insert display module board carefully to prevent breaking spring locking tabs on front cover. When installing display module, carefully slide top of board into top of front cover, making sure board is fully seated into tabs. Then, carefully rotate bottom of board into position so spring locking tabs spring back and lock without cracking or breaking. **DO NOT FORCE** bottom or top of display board into position.

HINT: When customers report broken buttons on their dishwashers, the cause is almost always broken tabs on the front cover. The white or black buttons on the fascia panel and the control module keypad rarely fail.

NOTE: The # 264946 front cover has a short lead time while control modules have long four month lead times (from Germany). Using the cover to replace broken buttons will avoid delays in obtaining parts.

HINT: Use the # 264946 front cover instead of replacing an older 263832 module with a 266746 module to save customers time and money. Many 263832 modules have been replaced merely for broken buttons.

CAUTION: Some pc board components are sensitive to static electricity and can be damaged by personnel through touch or close proximity. Personnel handling pc boards should be grounded.

NOTE: To determine which control module you have, check the model #'s on the following list:

266746 -- SHU 5302/5304/5305/5306/5312/5314/5315/5316/6802/6805/6806 UC 11 - UC/12, SHU 5307/5317 UC/12 and SHI 6802/6805/6806 UC/11 - UC/12.

263832 -- SHU 5302/5304/5305/5306/5312/5314/5315/5316/6802/6805/6806 UC 06 and SHI 6802/6805/6806 UC/06.

264461 -- SHU 4302/4306/4312/4316 UC 06 - UC/11 - UC/12 and SHI 4302/4306 UC/06 - UC/11 - UC/12.

**Soldering # 266746, 263832 or 264461 Control Modules for SHU/I 43/53/68
& GM 915-710 Dishwashers (excepting SHU 4322/4326)**

Occasionally, a heater relay terminal soldered to a # **266746**, **263832** or **264461** control module pc board can burn. Heater relays can be resoldered to save customers time and money. Please follow these instructions carefully when resoldering a heater relay terminal.

CAUTION:

- ☑ **Do not overheat solder joint** -- pc board can be damaged by excessive heat. Make sure soldering iron is fully heated before soldering and keep heating time as short as possible.
- ☑ Use **rosin core 60/40 solder** when soldering pc boards as acid core can etch pc boards.
- ☑ **Do NOT resolder if relay terminal or pc board is damaged** -- replace entire control module.
- ☑ To avoid overheating pc board, use a moderately sized soldering iron (~ 25W).

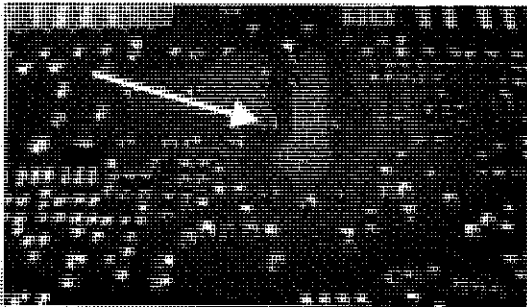

Good board -- showing proper soldering on back of pc board.

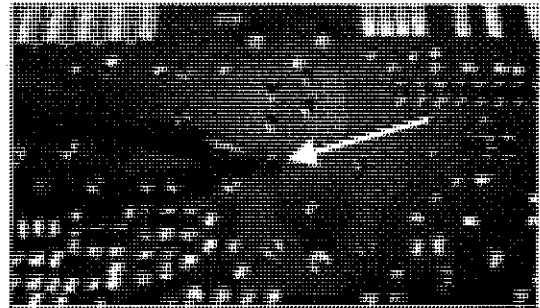

Burned board -- showing burned terminal on back of pc board.

HINT: Soldering irons give superior results compared to soldering guns - using an iron with a small tip (~ 25W) reduces possibility of damaging pc board.

CAUTION: Some pc board components are sensitive to static electricity and can be damaged by personnel through touch or close proximity. Personnel handling pc boards should be grounded.

HINT: The heater relay is the **largest** of three relays in the center of the pc board & can be one of two colors:

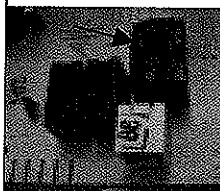

Black

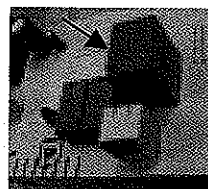

Orange

DETAILED INSTRUCTIONS:

1. Carefully clean burned terminal with a small piece of extra fine sandpaper, taking care not to scratch pc board.
2. Use an iron with a **small tip**. Heat soldering iron up to temperature. Coat tip with small amount of solder.
3. Using **rosin core 60/40 solder**, hold tip of hot iron to terminal and **briefly** touch terminal with solder. Don't use excessive amount of solder to avoid damaging pc board.
4. Pull iron from terminal and let solder joint cool.
5. Inspect solder joint -- a good solder joint should be shiny, not dull. If solder joint is dull, carefully resolder.
6. If joint is sound, carefully clean finished joint with a clean cloth. Carefully remove any lint from pc board.
7. Reinstall pc board to control module, then reinstall control module to dishwasher. Check dishwasher and make sure it operates properly, including how it heats.

SHU/SHI/SHV Dishwasher Quick Check Chart

Use this chart to quickly identify problems from front of dishwasher without removing it. For a complete troubleshooting chart when symptoms are known, please refer to the **SHU/SHI/SHV Dishwasher Troubleshooting Chart**.

NOTE: Use a multimeter with temperature, voltage/resistance and current (ampere) probes. Do all resistance checks with power turned off. Identify each wire color and location at the control module before looking at this chart. For a quick reference for measuring resistances from the front of the dishwasher, please refer to the one page diagram **Measuring Resistances from the Front of any SHU or SHI Dishwasher**.

NOTE: To access wire harnesses, open door and remove outer door panel (by removing three T20 Torx screws on each side of inner door, starting from bottom – the top six screws hold the fascia panel to the door). Once screws are out, close door, lift outer door panel up and pull bottom of panel out – door panel will drop out.

NOTE: Please see schematic diagram #36 for SHU/I 43/53/68 model dishwashers and diagram #48 for SHV 43/48 model dishwashers in the **Major Appliance Technical Manual**.

NOTE: An "F" fault code in the display for SHU/I 53/68 dishwashers shows there's a filling problem (not filling, overfilling, underfilling or water in the base). The fault code can't be reset manually – it will reset itself 15 minutes after the dishwasher has been turned on (after testing how it fills).

To check	Measure	If yes	If no
✓ Water valve	✓ Resistance through water valve terminals ($\approx 1000 \Omega$).	✓ Valve may be OK – more testing may be needed.	✓ Turn off dishwasher and replace water valve.
✓ Drain motor	✓ Lift plastic terminal cover and measure resistance through drain motor terminals ($\approx 16.5 \Omega$). <i>HINT: Locking type terminals are used – push a small (#1) blade screwdriver into each terminal notch and slide terminal off at same time.</i> <i>HINT: Start test program, start any wash cycle or reset dishwasher to run drain motor – see if water drains.</i>	✓ Drain motor may be OK – more testing may be needed.	✓ Turn off dishwasher and replace drain motor. <i>HINT: The drain motor is not a bilge pump – it won't remove water from the dishwasher base.</i>

SHU/SHI/SHV Dishwasher Quick Check Chart

To check	Measure	If yes	If no
<p>✓ Heater /flow switch /Hi-Limit thermostat (185°F)</p>	<p>✓ Current through hot wire into dishwasher – should be 10.5-11 A (amps).</p> <p><i>HINT: The resistance of heater is $\approx 11 \Omega$, Hi-Limit thermostat is $\approx .3 \Omega$ & flow switch is $\approx .4 \Omega$. To measure flow switch resistance, remove microswitch & close its contacts.</i></p> <p><i>HINT: The NTC and Hi-Limit (185°F thermostat) are changed as a unit. Must pull out dishwasher and remove or block up tub to replace it.</i></p>	<p>✓ Heater/flow switch/Hi-Limit thermostat are OK.</p> <p><i>HINT: Don't pull out dishwasher and remove tub for initial checking – only when you're certain one of these parts has failed.</i></p> <p><i>HINT: Start test program (SHU/I models) and skip "draining" and "Aqua Sensor Calibration" until water has finished filling. When heater comes on, measure current. Skip "heating & circulating" once you've measured current to save time.</i></p>	<p>✓ Test each part, turn off dishwasher and replace defective part.</p> <p><i>HINT: Must pull out dishwasher and remove or tilt/block up tub to replace parts. Bring all three parts before disassembling dishwasher and test each part separately.</i></p> <p><i>HINT: The Hi-Limit thermostat (185°F) is a bi-metal self-resetting thermostat.</i></p>
<p>✓ NTC (temperature probe)</p>	<p>✓ At control module, measure resistance between two brown wires at left of right harness ($\approx 55 \text{ k}\Omega$ at room temperature (72°F)).</p> <p><i>HINT: Make sure water in sump has cooled to room temperature before measuring resistance.</i></p>	<p>✓ NTC probably is OK.</p>	<p>✓ Turn off dishwasher and replace NTC.</p> <p><i>HINT: The NTC and Hi-Limit (185°F thermostat) are changed as a unit. Must pull out dishwasher and remove or block up tub to replace it.</i></p>
<p>✓ Water level switch</p>	<p>✓ After water fills, turn off dishwasher and measure (SHU/I models) between white wire at left of 3rd harness from left and 2nd blue wire from left of 4th harness from left ($\approx .4 \Omega$).</p>	<p>✓ Water level switch is OK.</p> <p><i>HINT: For SHV models, measure between white wire at right of 1st harness & white wire at left of 4th harness.</i></p>	<p>✓ Turn off dishwasher and replace water level switch.</p> <p><i>HINT: Must pull out dishwasher and remove left side panel to access water level switch.</i></p>
<p>✓ Float switch</p>	<p>✓ Resistance between white wire to water valve and white wire either at right of on/off switch harness (SHU/I models) or at left of 4th harness (SHV models) ($\approx 4\Omega$).</p>	<p>✓ Float switch and water valve probably are OK.</p>	<p>✓ Test float switch and water valve, turn off dishwasher and replace whatever part was defective.</p>

SHU/SHI/SHV Dishwasher Quick Check Chart

To check	Measure	If yes	If no
✓ Float switch (cont.)	<i>HINT:</i> Any debris (e.g. a cable tie) in dishwasher base can move under float and turn on float switch. Clean all debris from dishwasher base.		<i>HINT:</i> Must pull out dishwasher and remove left side panel to access float switch.
✓ Aqua sensor (SHU 53- & 68—only) <i>HINT:</i> The aqua sensor does <u>not</u> affect washability and should <u>not</u> be replaced (unless a leak has occurred around it).	✓ Find three brown wires at far right of control module. Measure resistance between middle wire and left (preferred) or right wire ($\geq 1 \text{ M}\Omega$). <i>HINT:</i> Don't check this unless customer has brought up long wash times (and has measured them). The sensor checks water clarity and adds a wash/rinse cycle only when the rinse water is still dirty.	✓ Sensor may be OK. <i>HINT:</i> Can also measure resistance between inner terminal (light) and either outer terminal (sensor) of sensor itself. <i>HINT:</i> Due to nature of sensor, resistance readings can be inconsistent.	✓ Turn off dishwasher and replace sensor. <i>HINT:</i> Must pull out dishwasher and remove left side panel to access sensor (for measuring or replacing). Sensor can be pulled out of sensor assembly at rear of sump.
✓ Circulation motor	✓ At control module, measure resistance (SHU/I models) between white/red wire on 1 st harness from left & 2 nd blue wire from right on 4 th harness from left ($\approx 10 \Omega$). <i>HINT:</i> For SHV models, measure between white/red wire at left of 2 nd harness & white wire at middle of 4 th harness.	✓ Circulation motor may be OK – more testing may be needed (if debris entered impeller). <i>HINT:</i> Debris can get in if filter basket wasn't properly screwed in and locked. Don't remove motor to clean impeller – remove filter basket/screen and reach through right side of sump into impeller.	✓ Turn off dishwasher and replace circulation motor. <i>HINT:</i> Must pull out dishwasher and remove or tilt/block up tub to remove or replace motor – do so only if certain motor has failed or impeller is jammed with debris.
✓ Detergent dispenser actuator	✓ Resistance through "wax" motor terminals ($\approx 2150 \Omega$).	✓ Actuator motor may be OK – more testing may be needed.	✓ Turn off dishwasher and replace actuator "wax" motor.
✓ Top rack only actuator (SHU/I 68- & SHV 48- models only).	✓ At control module, measure resistance (SHU/I models) between white wires of 3 rd harness (from left) - ($\approx 2150 \Omega$).	✓ Actuator motor may be OK – more testing may be needed. <i>HINT:</i> For SHV models, measure between white/red wire at left of 2 nd harness & white wire at middle of 4 th harness.	✓ Turn off dishwasher and replace actuator "wax" motor.

SHU/SHI/SHV Dishwasher Quick Check Chart

<i>To check</i>	<i>Measure</i>	<i>If yes</i>	<i>If no</i>
✓ Control module	✓ Run test program (SHU/I models) and check if indicator lights/displays come on and all buttons click (and resist a bit when pressed).	✓ Module may be OK – more testing may be needed.	✓ Go to troubleshooting chart and check whether module or another part is faulty.
✓ Rinse aid dispenser level switch (SHU 53/68 & SHV 48—models only)	✓ At control module, measure resistance between two yellow wires (2 nd harness from right) – ($\approx .4 \Omega$).	✓ Level switch probably is OK.	✓ Check to see if rinse aid dispenser is empty. If not, turn off dishwasher and replace level switch.

NOTE: The following parts can't be serviced from the front of the dishwasher (the dishwasher must be pulled out and the tank removed or tilted/blocked up to replace them):

- Heater
- Circulation motor
- Aqua sensor ("Sensotronic")
- NTC (temperature probe)/Hi-Limit (185°F) thermostat

NOTE: You will need a T20 Torx™ screwdriver and may need #1/ #2 flat blade screwdrivers and a pair of needlenose pliers. Many parts can be snapped out without using tools.

NOTE: On SHU/I-43/53/68 models, run test program to identify dishwasher problems (please see page F-1). The test can run more than one hour (to get temperature up to 150°F), but tests can be cancelled to greatly shorten testing time. The test program allows draining, filling, circulating and heating to be checked more quickly than running a standard wash cycle.

To use test program for troubleshooting, measure voltages/currents as parts come on. For example, run heating test and measure current coming into dishwasher – if current $\approx 11A$, Hi-Limit, heater and flow switch are OK. If not, check each part to see which one failed. This test saves time since you can't get to these parts without removing the tank and can't run resistance checks from front of dishwasher because flow switch stays open. Please see page B-1 on using test program to troubleshoot heater, flow switch and Hi-Limit.

SHU/SHI/SHV Dishwasher Quick Check Chart

NOTE: To cancel/drain dishwasher while it's cycling, press and hold the following buttons (until dishwasher starts to drain):

- | | |
|---|--|
| <input type="checkbox"/> SHU/I 43-- & SHV 43/48 | <input type="checkbox"/> Press and hold " Regular Wash " & " Power Scrub Plus " buttons |
| <input type="checkbox"/> SHU/I 53/68 | <input type="checkbox"/> Press and hold " Scrub Wash " & " Delicate/Economy " buttons until " CL " shows on display |

▲ WARNING!

ELECTRICAL SHOCK HAZARD (120 VAC)

- TURN OFF ELECTRICAL POWER AT THE CIRCUIT BREAKER OR FUSE BOX BEFORE DISASSEMBLING OR REPAIRING THE DISHWASHER.
- MAKE SURE THE DISHWASHER IS ELECTRICALLY GROUNDED.
- USE COPPER CONDUCTORS ONLY FOR ALL WIRING OR REWIRING. FAILURE TO FOLLOW THESE INSTRUCTIONS COULD RESULT IN SERIOUS INJURY OR DEATH.

SHU/SHI/SHV Dishwasher Troubleshooting Chart

NOTE: For minor problems from improper usage or lack of maintenance, please refer customer to the *Self-Help* chart in their *Use and Care Manual*.

Problem	Possible Cause	Suggested Action
<p>✓ Washability problems (dishwasher won't clean properly)</p> <p><i>HINT:</i> Water level will not affect washability as water fill is measured by pressure, not time – water level cannot be adjusted.</p>	<p>✓ Inappropriate dishwasher detergent used.</p> <p>✓ Blocked or clogged upper/lower spray arms.</p> <p>✓ Water doesn't circulate properly due to debris in circulation motor impeller.</p> <p>✓ Filter not locked down securely, allowing debris to enter sump.</p> <p><i>CAUTION:</i> Use caution when removing debris from sump to avoid being cut by sharp debris such as aluminum can tabs or broken glass.</p> <p>✓ Drain hose behind dishwasher doesn't have an adequate loop.</p> <p>✓ Partially clogged air gap, allowing wastewater from prior washes to circulate in dishwasher.</p> <p>✓ Water doesn't drain properly</p> <p>✓ Soap doesn't enter dishwasher due to dispenser actuator (A2) failure.</p>	<p>✓ Instruct customer to use a powdered dishwasher detergent (e.g. Cascade powder).</p> <p>✓ Check spray arms – clean or replace as needed.</p> <p>✓ Twist and remove filter, then remove debris from right side of sump where water enters circulation pump impeller. If debris has jammed impeller, turn off and pull out dishwasher, remove tank, remove circulation motor and unscrew and clean out impeller.</p> <p><i>HINT:</i> If impeller is damaged, replace entire impeller assembly or it won't seal adequately.</p> <p>✓ Twist and remove filter, then remove debris from sump. Instruct customer to twist and lock filter (cylinder) securely into sump.</p> <p><i>HINT:</i> Due to high temperature rinse (161°F) breaking down food debris and triple filtering system trapping food debris, filters shouldn't normally clog up. Problem often caused by filter not being securely locked down. Instruct customer to twist and lock filter (cylinder) securely into dishwasher sump.</p> <p>✓ Loop drain hose behind the dishwasher (with the top of the loop) at least 20" above the floor.</p> <p>✓ Unclog sink air gap.</p> <p><i>NOTE:</i> Cleaning sink air gaps is <u>not</u> covered under warranty.</p> <p>✓ See Water doesn't drain properly on page D-4.</p> <p>✓ Turn off dishwasher and test actuator – replace if faulty.</p>

SHU/SHI/SHV Dishwasher Troubleshooting Chart

Problem	Possible Cause	Suggested Action
✓ Washability problems (dishwasher won't clean properly) (cont.)	<i>HINT:</i> Must pull out dishwasher and remove left side panel to access float switch.	<i>HINT:</i> One "wax" motor operates both the detergent and rinse aid dispensers through a mechanical linkage. The system always resets when door closes. Check linkage by moving it manually. Check "wax" motor by running a continuity check on its terminals.
✓ Suds or foam remains in dishwasher.	<ul style="list-style-type: none"> ✓ Too much detergent used. ✓ Improper detergent used (other than powdered dishwasher detergent). ✓ Dishwasher doesn't drain properly. 	<ul style="list-style-type: none"> ✓ Instruct customer to use less. ✓ Instruct customer to use a powdered dishwasher detergent (e.g. Cascade powder). ✓ See Water doesn't drain properly on page D-4.
✓ Dishes won't dry properly.	<ul style="list-style-type: none"> ✓ Rinse aid not used. 	<ul style="list-style-type: none"> ✓ Instruct customer on using rinse aid – dishes won't dry without it.
✓ Dishwasher has an odor.	<ul style="list-style-type: none"> ✓ Standing water in dishwasher sump. <p><i>HINT:</i> Water level in sump should be at or below drain motor cover.</p> <ul style="list-style-type: none"> ✓ Standing water in dishwasher base. ✓ Minerals in customer water supply. ✓ Food debris in dishwasher filters. 	<ul style="list-style-type: none"> ✓ Unclog air gap. Make sure top of drain hose loop (behind dishwasher) is at least 20" above floor (add a loop in hose if there isn't one). ✓ Turn off dishwasher, drain water manually from dishwasher base and correct source of water leakage. ✓ Recommend customer to get water tested and use an appropriate water softener. ✓ Clean dishwasher filters.
✓ Dishwasher won't run or indicator lights won't come on.	<ul style="list-style-type: none"> ✓ Dishwasher not turned on. ✓ No power to dishwasher. ✓ Door ajar or on/off switch failed. ✓ Door latch has broken. ✓ Indicator light failed. 	<ul style="list-style-type: none"> ✓ Turn on/off switch on. ✓ Check customer circuit breaker, fuse box or power connections. ✓ Turn off dishwasher and check door or on/off switch -- adjust or replace them. ✓ Turn off dishwasher and replace door latch – instruct customer to not pull on door without pulling latch. ✓ Run test program to see if light failed (for SHU/I 43/53/68 models only – see page F-1). If so, turn off dishwasher and replace indicator light.

SHU/SHI/SHV Dishwasher Troubleshooting Chart

Problem	Possible Cause	Suggested Action
<ul style="list-style-type: none"> ✓ Dishwasher won't stop filling or won't stop draining. 	<ul style="list-style-type: none"> ✓ Water in dishwasher base from leaky or loose hose. ✓ Dishwasher isn't level, causing float switch (e6) to operate. ✓ Float switch or diaphragm (e6) failed. ✓ Debris in dishwasher base activated float switch (e6). 	<ul style="list-style-type: none"> ✓ Turn off dishwasher, drain water manually from dishwasher base and reinstall or replace hose. ✓ Level dishwasher using front and rear leveling legs (see customer dishwasher installation instructions). ✓ Turn off dishwasher and replace float switch or diaphragm. ✓ Turn off dishwasher and remove debris from dishwasher base
<ul style="list-style-type: none"> ✓ Water doesn't drain properly. <p><i>CAUTION: Use caution when removing debris from sump to avoid being cut by sharp debris such as aluminum can tabs or broken glass.</i></p>	<ul style="list-style-type: none"> ✓ Kink in drain hose. ✓ Dishwasher filter(s) or sump clogged. ✓ Drain motor impeller clogged. ✓ Kitchen sink or sink air gap clogged. ✓ Drain motor (m3) failed. ✓ Timer (SHU 30/40 models) or module (all other models) failed. ✓ Improper drain connection height (< 20" or 508mm above floor). 	<ul style="list-style-type: none"> ✓ Straighten or replace drain hose. ✓ Clean dishwasher filters or sump. ✓ Turn off dishwasher, remove drain motor cover (in sump) and clean impeller. If necessary, remove drain motor to clean impeller. ✓ Unclog sink or sink air gap. <p><i>NOTE: Cleaning sink air gaps or sinks are <u>not</u> covered under warranty.</i></p> <ul style="list-style-type: none"> ✓ Turn off dishwasher and measure resistance at motor terminals ($\approx 16.5 \Omega$). Replace faulty motor. ✓ Check voltage at and wiring to timer or module. Turn off dishwasher and replace faulty timer or module (for SHU/I 43/53 models, install existing module jumper onto new module). ✓ Install drain height and sink air gap according to local codes.
<ul style="list-style-type: none"> ✓ Water fills too slowly. 	<ul style="list-style-type: none"> ✓ Low customer water supply pressure. ✓ Inadequate customer water supply piping. ✓ Scale in customer supply piping or dishwasher piping/parts from hard water. 	<ul style="list-style-type: none"> ✓ Adjust customer water supply pressure (to 5-20 psi or 0.3-8.27 bars). ✓ Install appropriate piping to dishwasher (minimum 3/8" copper tanking) according to local codes. ✓ Clean or replace clogged piping/parts and have customer get water tested and use appropriate water softener.

SHU/SHI/SHV Dishwasher Troubleshooting Chart

Problem	Possible Cause	Suggested Action
<p>✓ Water won't fill.</p> <p><i>NOTE: An "F" fault code in the display for SHU/I 53/68 dishwashers shows there's a filling problem (not filling, overfilling, underfilling or water in the base). The fault code can't be reset manually – it will reset itself 15 minutes after the dishwasher has been turned on (after testing how it fills).</i></p>	<ul style="list-style-type: none"> ✓ Customer water supply turned off or disconnected. ✓ Water valve (s2) failed. ✓ Water level switch (f1) failed. ✓ Timer (SHU 30/40 models) or module (all other models) failed. ✓ Water in dishwasher base operated float switch (e6). 	<ul style="list-style-type: none"> ✓ Reconnect and turn on customer water supply. ✓ Check resistance @ water valve terminals ($\approx 1000 \Omega$). Turn off dishwasher and replace faulty valve. ✓ Turn off dishwasher and replace faulty level switch. ✓ Check voltage at and wiring to timer or module. Turn off dishwasher and replace faulty timer or module (for SHU/I 43/53 models, install existing module jumper onto new module). ✓ Turn off dishwasher, drain water manually from dishwasher base, find source of leaking water and fix water leak.
<p>✓ Detergent or rinse aid won't dispense properly.</p>	<ul style="list-style-type: none"> ✓ Dispenser actuator (A2) failed. ✓ Detergent dispenser door is jammed. 	<ul style="list-style-type: none"> ✓ Turn off dishwasher and replace actuator. ✓ Free jammed detergent dispenser door.
<p>✓ Refill rinse aid light won't come on (SHU/I 53/68 & SHV 48 models).</p>	<ul style="list-style-type: none"> ✓ Rinse aid level switch (reed switch e3) failed. 	<ul style="list-style-type: none"> ✓ Turn off dishwasher and replace reed switch.
<p>✓ Water doesn't circulate.</p>	<ul style="list-style-type: none"> ✓ Circulation motor (m2) failed. ✓ Timer (SHU 30/40 models) or module (all other models) failed. 	<ul style="list-style-type: none"> ✓ Turn off dishwasher and replace motor. ✓ Check voltage at and wiring to timer or module. Turn off dishwasher and replace faulty timer or module (for SHU/I 43/53 models, install existing module jumper onto new module).
<p>✓ Water doesn't heat up properly.</p>	<ul style="list-style-type: none"> ✓ Hi-Limit (f5) tripped and failed to reset. ✓ NTC (temperature sensor) failed. ✓ 140°F (f3) or 161°F (f4) thermostat (SHU 30/40 models) failed. 	<ul style="list-style-type: none"> ✓ Run test program (SHU/I 43/53/68 models) – measure current to dishwasher. If current $\approx 11A$, Hi-Limit is OK. If not (and for all other models), turn off dishwasher and measure resistance @ Hi-Limit terminals ($\approx .3 \Omega$). Replace faulty Hi-Limit. ✓ Turn off dishwasher and check resistance of NTC ($\approx 55 k\Omega @ 72^\circ F$). Replace faulty NTC. ✓ Turn off dishwasher and replace faulty thermostat.

SHU/SHI/SHV Dishwasher Troubleshooting Chart

Problem	Possible Cause	Suggested Action
<ul style="list-style-type: none"> ✓ Water doesn't heat up properly (cont.). 	<ul style="list-style-type: none"> ✓ Heater (r1) failed. ✓ Water flow switch (e5) failed. ✓ Timer (SHU 30/40 models) or module (all other models) failed. 	<ul style="list-style-type: none"> ✓ Run test program (SHU/I 43/53/68 models – see page B-1) – measure current to dishwasher. If current \approx 11A, heater is OK. If not (and for all other models), turn off dishwasher and measure heater resistance (\approx 11 Ω). Replace faulty heater. ✓ Run test program (SHU/I 43/53/68 models – see page B-1) – measure current to dishwasher. If current \approx 11A, flow switch is OK. If not, remove flow switch microswitch, close its contacts & measure its resistance (\approx .4 Ω). Replace faulty flow switch. ✓ Check voltage at and wiring to timer or module. Turn off dishwasher and replace faulty timer or module (for SHU/I 43/53 models, install existing module jumper onto new module).
<ul style="list-style-type: none"> ✓ Dishwasher cycle runs too long, yet dishwasher washes, rinses and shuts off OK. 	<ul style="list-style-type: none"> ✓ Customer hot water supply isn't hot enough ($<$ 140°F/ 60°C). 	<ul style="list-style-type: none"> ✓ Adjust hot water supply according to local codes.
<ul style="list-style-type: none"> ✓ Water leaks from front of dishwasher. 	<ul style="list-style-type: none"> ✓ Blocked or clogged upper or lower spray arms. ✓ Excessive foaming. ✓ Damaged door gasket. 	<ul style="list-style-type: none"> ✓ Check spray arms – clean or replace as needed. ✓ See Suds or foam remains in dishwasher on page D-2. ✓ Install new door gasket, providing an extra 1" – 1-1/4" on each side to cover bottom of tank (for a dam to prevent leaking from splashing water at bottom corners of tank). <p style="font-size: small; margin-top: 10px;"><i>HINT: Original gasket was longer to provide a dam for tank corners. Do not trim gasket flush with sides of tank or leaking may occur.</i></p>

NOTE: Use a multimeter with temperature, voltage/resistance and current (ampere) probes. Do all resistance checks with power turned off. Identify each wire color and location at the control module before looking at this chart. For a quick reference for measuring resistances from the front of the dishwasher, please refer to the one page diagram **Measuring Resistances from the Front of any SHU or SHI Dishwasher.**

SHU/SHI/SHV Dishwasher Troubleshooting Chart

NOTE: You will need a T20 Torx™ screwdriver and may need #1/ #2 flat blade screwdrivers and a pair of needlenose pliers. Many parts can be snapped out without using tools.

HINT: Symbols for parts (e.g. " f3" or "e6 ") refer to schematic diagram #36 on page E-1 and #48 on page E-2.

NOTE: The following parts can't be serviced from the front of the dishwasher (the dishwasher must be pulled out and the tank removed or tilted/blocked up to replace them):

- Heater
- Circulation motor
- Aqua sensor ("Sensotronic")
- NTC (temperature probe)/Hi-Limit (185°F) thermostat

NOTE: On SHU/I 43/53/68 models, run test program to identify dishwasher problems (see test program guide on page F-1). The test can run more than one hour (to get temperature up to 150°F), but tests can be cancelled to greatly shorten testing time. The test program allows draining, filling, circulating and heating to be checked more quickly than running a standard wash cycle.

To use test program for troubleshooting, measure voltages/currents as parts come on. For example, run heating test and measure current coming into dishwasher – if current ≈ 11A, Hi-Limit, heater and flow switch are OK. If not, check each part to see which one failed. This test saves time since you can't get to these parts without removing the tank and can't run resistance checks from front of dishwasher because flow switch stays open. Please see page B-1 on using test program to troubleshoot heater, flow switch and Hi-Limit.

NOTE: To cancel/drain dishwasher while it's cycling, press and hold the following buttons (until dishwasher starts to drain):

- | | |
|---|---|
| <ul style="list-style-type: none"> □ SHU/I 43-- & SHV 43/48 □ SHU/I 53/68 | <ul style="list-style-type: none"> □ Depress and hold "Regular Wash" & "Power Scrub Plus" buttons □ Depress and hold "Scrub Wash" & "Delicate/Economy" buttons until "CL" shows on display |
|---|---|

NOTE: Jumpers aren't included with replacement modules. For SHU/I 43/53 models, take jumper off old module and put it on new module.

NOTE: An "F" fault code in the display for SHU/I 53/68 dishwashers shows there's a filling problem (not filling, overfilling, underfilling or water in the base). The fault code can't be reset manually – it will reset itself 15 minutes after the dishwasher has been turned on (after testing how it fills).

SHU/SHI/SHV Dishwasher Troubleshooting Chart

NOTE: The customer hot water supply should meet or exceed the minimum requirements below for the dishwasher to operate efficiently. - Installations not meeting these requirements should be reinstalled according to local codes.

- 20-60 psi (1.4 - 4.1 bars) water pressure
- 140°F (60°C) water temperature (recommended)
- minimum 3/8" (9.5 mm) flexible stainless steel or copper tanking inlet line

▲ WARNING!

ELECTRICAL SHOCK HAZARD (120 VAC)

- TURN OFF ELECTRICAL POWER AT THE CIRCUIT BREAKER OR FUSE BOX BEFORE DISASSEMBLING OR REPAIRING THE DISHWASHER.
- MAKE SURE THE DISHWASHER IS ELECTRICALLY GROUNDED.
- USE COPPER CONDUCTORS ONLY FOR ALL WIRING OR REWIRING. FAILURE TO FOLLOW THESE INSTRUCTIONS COULD RESULT IN SERIOUS INJURY OR DEATH.

DIAGRAM #48

BOSCH

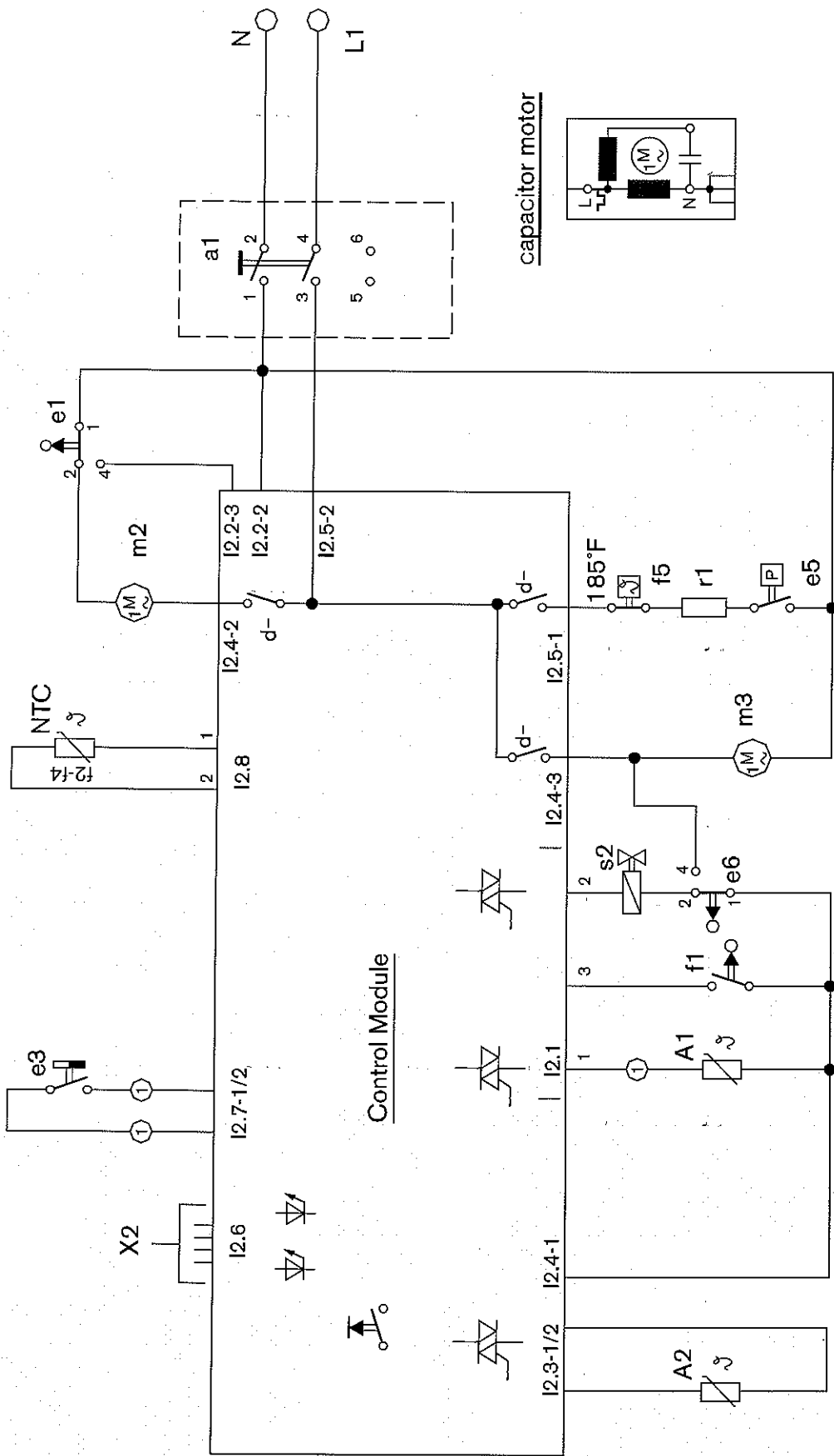

SHV 43/48

Symbol Key	
a1	ON/OFF SWITCH
A1	ACTUATOR (Upper Basket)
A2	ACTUATOR (Dispenser)
e0	DOOR SWITCH
e3	REED SWITCH
e5	FLOW SWITCH
e6	FLOAT SWITCH
f1	WATER LEVEL SWITCH
f5	HIGH LIMIT 185°F
I4	AQUA SENSOR
m2	CIRCULATION MOTOR
m3	DRAIN MOTOR
NTC	TEMPERATURE SENSOR
r1	HEATING ELEMENT
s2	WATER SOLENOID
X1	JUMPER
X2	SERVICE CONNECTOR

① SHV 4803 only

SHI/U 43/53/68 Dishwasher Test Programs

TEST*	TIME	NOTES
Draining	30 seconds	
Aqua Sensor ("Sensotronic") Calibration	65 seconds	Not on SHI/U 43-- models
Filling	Until Water Level Switch (f1) closes	Can't skip this test
Heating & Circulating	Until water temperature reaches 150°F (65°C)	Dispenser actuator comes on
Draining	60 seconds	

* To skip a test: **SHI/U 43 models** Press **SCRUB WASH** button.
 SHI/U 53/ 68 models Press **REGULAR WASH** button.

SHU 4322 & 4326 MODELS

To start test program, press and hold both **REGULAR WASH** and **RINSE & HOLD** program buttons, then turn unit on by pressing **ON/OFF** button. Initially, control module version # will be displayed (e.g./ "20" = version 0 without jumper). When wash program buttons are released, lights above them will flash. To end test program, press **ON/OFF** button.

To check each program indicator light, press its button. To check **Cycle Countdown** display, **Refill Rinse Agent** light and **REGULAR WASH** light, press **REGULAR WASH** button (press **Delay Start** button to test **Cycle Countdown** display alone). **Cycle Countdown** display will show "88" when **REGULAR WASH** button is pressed and "8h" when **Delay Start** button is pressed.

To start testing, press both the **REGULAR WASH** and **RINSE & HOLD** buttons a second time. When testing has ended, **Cycle Countdown** display will show a fault using codes below. If more than one fault occurs, code numbers will be added together, (e.g./ "6" = faults 2 + 4).

- | | | |
|---------------------------------------|-------------------|--|
| 0 = No faults detected | 2 = Heating fault | 8 = NTC (temperature sensor) fault |
| 1 = Aqua Sensor ("Sensotronic") fault | 4 = Filling fault | F = Filling fault (display occurs during wash, not test) |

To check for heater, high limit or flow switch problems, start testing until heating starts. Using a meter with a current coil, measure current going into dishwasher. If current is ~ 11 A, then heater, high limit and flow switch are OK. If current stays at ~ 1.5-2 A, then heater, high limit or flow switch are faulty.

If water level switch (f1) has failed (opened), display will show fault code "4" and unit will continually fill and drain where testing won't be completed. If flow switch (e5) has failed (opened), display will show "0", water won't heat (to 150°F) and water won't stop circulating. If NTC probe (f2/f4) has failed (opened), display will show fault code "8" immediately and testing will end shortly after water has started circulating.

SHU 4322/4326 models program buttons & indicator lights:



See page F-1A for SHI/U 43 models, F-1C for SHU 53 models and page F-1D for SHI/U 68 models

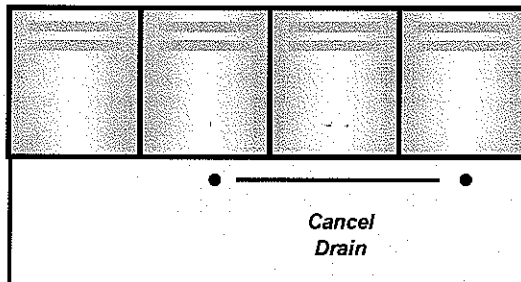

SHI/U 43/53/68 Dishwasher Test Programs

TEST*	TIME	NOTES
Draining	30 seconds	
Aqua Sensor ("Sensotronic") Calibration	65 seconds	Not on SHI/U 43-- models
Filling	Until Water Level Switch (f1) closes	Can't skip this test
Heating & Circulating	Until water temperature reaches 150°F (65°C)	Dispenser actuator comes on
Draining	60 seconds	

* To skip a test: SHI/U 43 models Press **SCRUB WASH** button.
 SHI/U 53/ 68 models Press **REGULAR WASH** button.

SHU 53 MODELS

To start test program, press and hold both **SCRUB WASH** and **DELICATE/ECONO** program buttons, then turn unit on by pressing **ON/OFF** button. Initially, control module version # will be displayed (e.g./ "21" = version 1 with jumper). When wash program buttons are released, lights above them will flash. To end test program, press **ON/OFF** button.

To check each program indicator light, press its button. To check **Cycle Countdown** display, **Refill Rinse Agent** light and **REGULAR WASH** light; press **REGULAR WASH** button (press **Delay Start** button to test **Cycle Countdown** display alone). **Cycle Countdown** display will show "88" when **REGULAR WASH** button is pressed and "8h" when **Delay Start** button is pressed.

To start testing, press both the **SCRUB WASH** and **DELICATE/ECONO** buttons a second time. When testing has ended, **Cycle Countdown** display will show a fault using codes below. If more than one fault occurs, code numbers will be added together, (e.g./ "6" = faults 2 + 4).

- | | | |
|---------------------------------------|-------------------|--|
| 0 = No faults detected | 2 = Heating fault | 8 = NTC (temperature sensor) fault |
| 1 = Aqua Sensor ("Sensotronic") fault | 4 = Filling fault | F = Filling fault (display occurs during wash, not test) |

To check for heater, high limit or flow switch problems, start testing until heating starts. Using a meter with a current coil, measure current going into dishwasher. If current is ~ 11 A, then heater, high limit and flow switch are OK. If current stays at ~ 1.5-2 A, then heater, high limit or flow switch are faulty.

If water level switch (f1) has failed (opened), display will show fault code "4" and unit will continually fill and drain where testing won't be completed. If flow switch (e5) has failed (opened), display will show "0", water won't heat (to 150°F) and water won't stop circulating. If NTC probe (f2/f4) has failed (opened), display will show fault code "8" immediately and testing will end shortly after water has started circulating.

SHU 53 models program buttons & indicator lights:

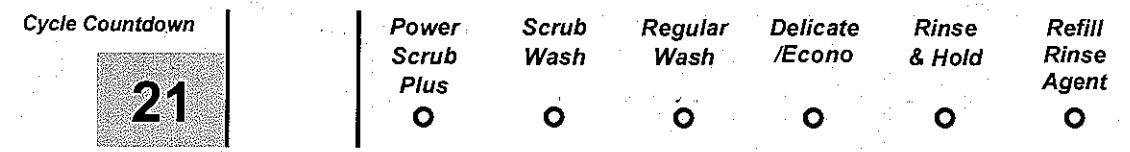

See page F-1A for SHI/U 43 models, F-1B for SHU 4322/4326 models and page F-1D for SHI/U 68 models

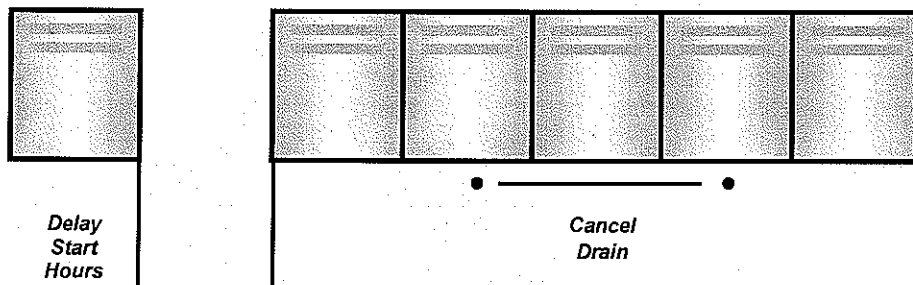

SHI/U 43/53/68 Dishwasher Test Programs

TEST*	TIME	NOTES
Draining	30 seconds	
Aqua Sensor ("Sensotronic") Calibration	65 seconds	Not on SHI/U 43-- models
Filling	Until Water Level Switch (f1) closes	Can't skip this test
Heating & Circulating	Until water temperature reaches 150°F (65°C)	Dispenser actuator comes on
Draining	60 seconds	

* To skip a test: SHI/U 43 models Press **SCRUB WASH** button.
 SHI/U 53/ 68 models Press **REGULAR WASH** button.

SHI/U 68-- MODELS

To start test program, press and hold both **SCRUB WASH** and **DELICATE/ECONO** program buttons, then turn unit on by pressing **ON/OFF** button. Initially, control module version # will be displayed (e.g./ "20" = version 0 without jumper). When wash program buttons are released, lights above them will flash. To end test program, press **ON/OFF** button.

To check each program indicator light, press its button. To check **Cycle Countdown** display, **Refill Rinse Agent** light and **REGULAR WASH** light, press **REGULAR WASH** button (press **Delay Start** button to test **Cycle Countdown** display alone). **Cycle Countdown** display will show "88" when **REGULAR WASH** button is pressed and "8h" when **Delay Start** button is pressed.

To start testing, press both **SCRUB WASH** and **DELICATE/ECONO** buttons a second time. When testing has ended, **Cycle Countdown** display will show a fault using codes below. If more than one fault occurs, code numbers will be added together, (e.g./ "6" = faults 2 + 4).

- 0 = No faults detected 2 = Heating fault 8 = NTC (temperature sensor) fault
- 1 = Aqua Sensor ("Sensotronic") fault 4 = Filling fault F = Filling fault (display occurs during wash, not test)

To check for heater, high limit or flow switch problems, start testing until heating starts. Using a meter with a current coil, measure current going into dishwasher. If current is ~ 11 A, then heater, high limit and flow switch are OK. If current stays at ~ 1.5-2 A, then heater, high limit or flow switch are faulty.

If water level switch (f1) has failed (opened), display will show fault code "4" and unit will continually fill and drain where testing won't be completed. If flow switch (e5) has failed (opened), display will show "0", water won't heat (to 150°F) and water won't stop circulating. If NTC probe (f2/f4) has failed (opened), display will show fault code "8" immediately and testing will end shortly after water has started circulating.

SHU 68 models program buttons & indicator lights:

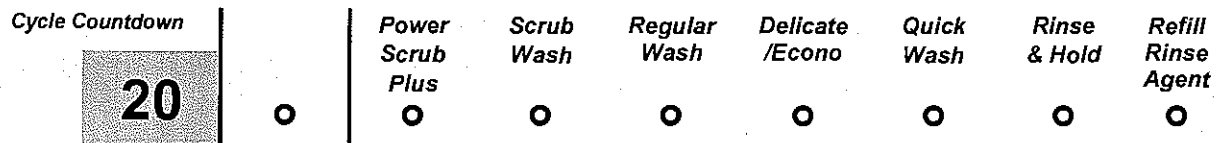

See page F-1A for SHI/U 43 models, F-1B for SHU 4322/4326 models and page F-1C for SHU 53 models

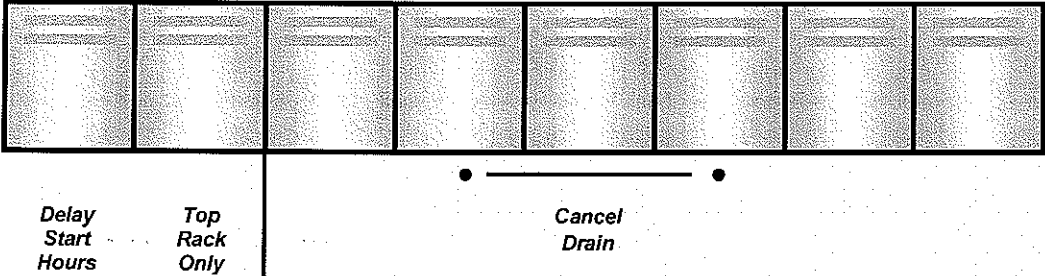

SHV 43/48 Dishwasher Test Program

TEST*	TIME	NOTES
Draining	30 seconds	
Filling	Until Water Level Switch (<i>f1</i>) closes	Input current < 1 A
Heating & Circulating <i>(water circulates before unit stops filling)</i>	Until water temperature reaches 150°F (65°C)	Input current ~ 11 A and dispenser actuator comes on
Draining	60 seconds	

* To skip Heating & Circulating test: SHV 43/48 models Press **SCRUB WASH** button.

SHV 43/48 MODELS

To start test program, press and hold both **POWER SCRUB PLUS** and **REGULAR WASH** program buttons, then turn unit on by pressing **ON/OFF** button. When program buttons are released, lights above them will flash. To end test program, press **ON/OFF** button. **NOTE: TO ENABLE LIGHTS TO COME ON, DOOR MUST BE OPENED.**

To check program indicator lights (**POWER SCRUB PLUS**, **SCRUB WASH**, **REGULAR WASH** and **RINSE & HOLD**), press and hold each program button. When **SCRUB WASH** program button is pressed, **CLEAN** and **REFILL RINSE AGENT** lights also come on (for **SHV 4803** models) or **CLEAN** light also comes on (for **SHV 4303** models). **NOTE: TO ENABLE LIGHTS TO COME ON, DOOR MUST BE OPENED.**

To start testing, press both **POWER SCRUB PLUS** and **REGULAR WASH** buttons a second time. When testing has ended and a fault was detected, the following indicator lights will be lit:

- POWER SCRUB PLUS** = Heater fault
- SCRUB WASH** = Water filling fault (*over or under filling*)
- REGULAR WASH** = NTC (temperature sensor) fault – *note circulation motor stops shortly after it started during an NTC fault*

To check for heater, high limit or flow switch problems, start testing until heating starts. Using a meter with a current coil, measure current going into dishwasher. If current is ~ 11 A, then heater, high limit and flow switch are OK. If current stays at ~ 1.5-2 A, then heater, high limit or flow switch are faulty.

If water level switch (*f1*) has failed (opened), **SCRUB WASH** light will come on and unit will continually fill and drain where testing won't be completed. If flow switch (*e5*) has failed (opened), water won't heat (to 150°F) and water won't stop circulating. If NTC probe (*f2/f4*) has failed (opened), **REGULAR WASH** light will come on immediately and testing will end shortly after water has started circulating. **NOTE: TO ENABLE LIGHTS TO COME ON, DOOR MUST BE OPENED.**

If more than one fault occurs, more than one light will be lit.

SHV 4303 models program buttons & indicator lights:



SHV 4803 models program buttons & indicator lights:

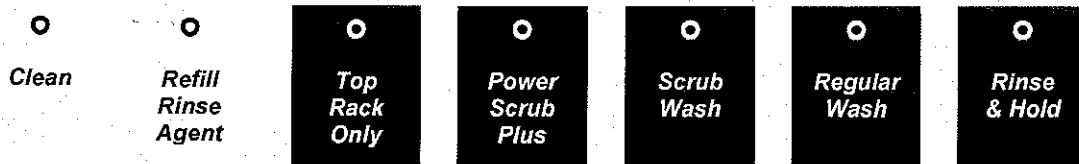

SHU 99 Dishwasher Test Program

TEST*	TIME	NOTES
Draining	30 seconds	
Filling	Until Water Level Switch (<i>f1</i>) closes	Input current < 1 A
Heating & Circulating (<i>water circulates before unit stops filling</i>)	Until water temperature reaches 150°F (65°C)	Input current ~ 11 A and dispenser actuator comes on
Draining	60 seconds	

***To skip Heating & Circulating test:**

SHU 9902/9905/9906 (Millennium) models

Press **SCRUB WASH** button.

SHU 991x (Integra) models

Press **REGULAR WASH** button.

SHU 992x (Integra) models

Press **REGULAR WASH** button.

SHU 9902/9905/9906 (Millennium) MODELS

To start test program, press and hold both **POWER SCRUB PLUS** and **REGULAR WASH** program buttons, then turn unit on by pressing **ON/OFF** button. When program buttons are released, lights above them will flash. To end test program, press **ON/OFF** button.

To check program indicator lights (**POWER SCRUB PLUS**, **SCRUB WASH**, **REGULAR WASH** and **RINSE & HOLD**), press and hold each program button. When **SCRUB WASH** program button is pressed, **CLEAN** light also comes on.

To start testing, press both **POWER SCRUB PLUS** and **REGULAR WASH** buttons a second time. When testing has ended and a fault was detected, the following indicator lights will be lit:

POWER SCRUB PLUS = Heater fault
SCRUB WASH = Water filling fault (*over or under filling*)
REGULAR WASH = NTC (temperature sensor) fault – *note circulation motor stops shortly after it started during an NTC fault*

To check for heater, high limit or flow switch problems, start testing until heating starts. Using a meter with a current coil, measure current going into dishwasher. If current is ~ 11 A, then heater, high limit and flow switch are OK. If current stays at ~ 1.5-2 A, then heater, high limit or flow switch are faulty.

If water level switch (*f1*) has failed (opened), **SCRUB WASH** light will come on and unit will continually fill and drain where testing won't be completed. If flow switch (*e5*) has failed (opened), water won't heat (to 150°F) and water won't stop circulating. If NTC probe (*f2/f4*) has failed (opened), **REGULAR WASH** light will come on immediately and testing will end shortly after water has started circulating.

If more than one fault occurs, more than one light will be lit.

SHU 9902/9905/9906 (Millennium) models program buttons & indicator lights:



See page F-3B for SHU 991x UC/06-UC/11 (Integra) Models, F-3C for SHU 991x UC/12 (Integra) Models & F-3D for SHU 992x UC/12 (Integra) Models

SHU 99 Dishwasher Test Program

TEST	TIME	NOTES
Draining	30 seconds	
Filling	Until Water Level Switch (f1) closes	Input current < 1 A
Heating & Circulating <i>(water circulates before unit stops filling)</i>	Until water temperature reaches 150°F (65°C)	Input current ~ 11 A and dispenser actuator comes on
Draining	60 seconds	

***To skip Heating & Circulating test:**

- | | |
|--|-----------------------------------|
| SHU 9902/9905/9906 (Millennium) models | Press SCRUB WASH button. |
| SHU 991x (Integra) models | Press REGULAR WASH button. |
| SHU 992x (Integra) models | Press REGULAR WASH button. |

SHU 991x UC/06 & UC/11 (Integra) MODELS

To start test program, press and hold both **POWER SCRUB PLUS** and **QUICK WASH** program buttons, then turn unit on by pressing **ON/OFF** button. When program buttons are released, lights above them will flash. To end test program, press **ON/OFF** button.

To check program indicator lights (**POWER SCRUB PLUS**, **REGULAR WASH**, **QUICK WASH** and **RINSE & HOLD**), press and hold each program button. When **REGULAR WASH** program button is pressed, **CLEAN** light also comes on and an audible tone ("beep") also occurs.

To start testing, press both **POWER SCRUB PLUS** and **QUICK WASH** buttons a second time. When testing has ended and a fault was detected, the following indicator lights will be lit:

- POWER SCRUB PLUS** = Heater fault
- REGULAR WASH** = Water filling fault (*over or under filling*)
- QUICK WASH** = NTC (temperature sensor) fault – *note circulation motor stops shortly after it started during an NTC fault*

To check for heater, high limit or flow switch problems, start testing until heating starts. Using a meter with a current coil, measure current going into dishwasher. If current is ~ 11 A, then heater, high limit and flow switch are OK. If current stays at ~ 1.5-2 A, then heater, high limit or flow switch are faulty.

If water level switch (f1) has failed (opened), **REGULAR WASH** light will come on and unit will continually fill and drain where testing won't be completed. If flow switch (e5) has failed (opened), water won't heat (to 150°F) and water won't stop circulating. If NTC probe (f2/f4) has failed (opened), **QUICK WASH** light will come on immediately and testing will end shortly after water has started circulating.

If more than one fault occurs, more than one light will be lit.

SHU 991x UC/06 & UC/11 (Integra) models program buttons & indicator lights:



See page F-3A for SHU 9902/9905/9906 (Millennium) Models. F-3C for SHU 991x UC/12 (Integra) Models & F-3D for SHU 992x UC/12 (Integra) Models

SHU 99 Dishwasher Test Program

TEST*	TIME	NOTES
Draining	30 seconds	
Filling	Until Water Level Switch (f1) closes	Input current < 1 A
Heating & Circulating (water circulates before unit stops filling)	Until water temperature reaches 150°F (65°C)	Input current ~ 11 A and dispenser actuator comes on
Draining	60 seconds	

***To skip Heating & Circulating test:**

SHU 9902/9905/9906 (Millennium) models

Press **SCRUB WASH** button.

SHU 991x (Integra) models

Press **REGULAR WASH** button.

SHU 992x (Integra) models

Press **REGULAR WASH** button.

SHU 991x UC/12 (Integra) MODELS

To start test program, press and hold both **POWER SCRUB PLUS** and **DELICATE/ECONO** program buttons, then turn unit on by pressing **ON/OFF** button. When program buttons are released, lights above them will flash. To end test program, press **ON/OFF** button.

To check program indicator lights (**POWER SCRUB PLUS**, **REGULAR WASH**, **DELICATE/ECONO** and **RINSE & HOLD**), press and hold each program button. When **REGULAR WASH** program button is pressed, **CLEAN** light also comes on and an audible tone ("beep") also occurs.

To start testing, press both **POWER SCRUB PLUS** and **DELICATE/ECONO** buttons a second time. When testing has ended and a fault was detected, the following indicator lights will be lit:

POWER SCRUB PLUS	=	Heater fault
REGULAR WASH	=	Water filling fault (over or under filling)
DELICATE/ECONO	=	NTC (temperature sensor) fault – note circulation motor stops shortly after it started during an NTC fault

To check for heater, high limit or flow switch problems, start testing until heating starts. Using a meter with a current coil, measure current going into dishwasher. If current is ~ 11 A, then heater, high limit and flow switch are OK. If current stays at ~ 1.5-2 A, then heater, high limit or flow switch are faulty.

If water level switch (f1) has failed (opened), **REGULAR WASH** light will come on and unit will continually fill and drain where testing won't be completed. If flow switch (ø5) has failed (opened), water won't heat (to 150°F) and water won't stop circulating. If NTC probe (f2/f4) has failed (opened), **DELICATE/ECONO** light will come on immediately and testing will end shortly after water has started circulating.

If more than one fault occurs, more than one light will be lit.

SHU 991x UC/12 (Integra) models program buttons & indicator lights:

NOTE: All Integra UC/12 models use the same control module # 481055 and have the same wash programs.



See page F-3A for SHU 9902/9905/9906 (Millennium) Models, F-3B for SHU 991x UC/06-UC/11 (Integra) Models & F-3D for SHU 992x UC/12 (Integra) Models

SHU 99 Dishwasher Test Program

TEST	TIME	NOTES
Draining	30 seconds	
Filling	Until Water Level Switch (f1) closes	Input current < 1 A
Heating & Circulating <i>(water circulates before unit stops filling)</i>	Until water temperature reaches 150°F (65°C)	Input current ~ 11 A and dispenser actuator comes on
Draining	60 seconds	

***To skip Heating & Circulating test:**

- | | |
|--|-----------------------------------|
| SHU 9902/9905/9906 (Millennium) models | Press SCRUB WASH button. |
| SHU 991x (Integra) models | Press REGULAR WASH button. |
| SHU 992x (Integra) models | Press REGULAR WASH button. |

SHU 992x UC/12 (Integra) MODELS

To start test program, press and hold both **POWER SCRUB PLUS** and **DELICATE/ECONO** program buttons, then turn unit on by pressing **ON/OFF** button. When program buttons are released, lights above them will flash. To end test program, press **ON/OFF** button.

To check program indicator lights (**POWER SCRUB PLUS**, **REGULAR WASH**, **DELICATE/ECONO** and **RINSE & HOLD**), press and hold each program button. When **REGULAR WASH** program button is pressed, **CLEAN** light also comes on and an audible tone ("beep") also occurs.

To start testing, press both **POWER SCRUB PLUS** and **DELICATE/ECONO** buttons a second time. When testing has ended and a fault was detected, the following indicator lights will be lit:

- | | | |
|-------------------------|---|---|
| POWER SCRUB PLUS | = | Heater fault |
| REGULAR WASH | = | Water filling fault (<i>over or under filling</i>) |
| DELICATE/ECONO | = | NTC (temperature sensor) fault – <i>note circulation motor stops shortly after it started during an NTC fault</i> |

To check for heater, high limit or flow switch problems, start testing until heating starts. Using a meter with a current coil, measure current going into dishwasher. If current is ~ **11 A**, then heater, high limit and flow switch are OK. If current stays at ~ **1.5-2 A**, then heater, high limit or flow switch are faulty.

If water level switch (f1) has failed (opened), **REGULAR WASH** light will come on and unit will continually fill and drain where testing won't be completed. If flow switch (e5) has failed (opened), water won't heat (to 150 F) and water won't stop circulating. If NTC probe (f2/f4) has failed (opened), **DELICATE/ECONO** light will come on immediately and testing will end shortly after water has started circulating.

If more than one fault occurs, more than one light will be lit.

SHU 992x UC/12 (Integra) models program buttons & indicator lights:

NOTE: All Integra UC/12 models use the same control module # 481055 and have the same wash programs.

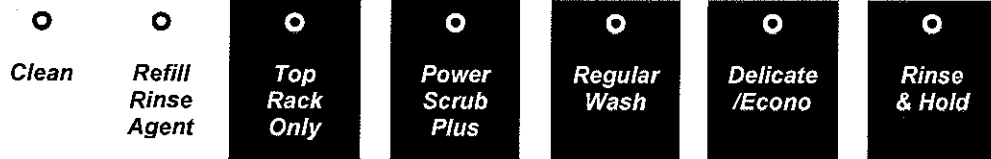

See page F-3A for SHU 9902/9905/9906 (Millennium) Models, F-3B for SHU 991x UC/06-UC/11 (Integra) Models & F-3C for SHU 991x UC/12 (Integra) Models

SHU 33 Dishwasher Test Program

TEST*	TIME	NOTES
Draining	30 seconds	
Filling	Until Water Level Switch (f1) closes	Input current < 1 A
Heating & Circulating (water circulates before unit stops filling)	Until water temperature reaches 150°F (65°C)	Input current ~ 11 A and dispenser actuator comes on
Draining	60 seconds	

* To skip Heating & Circulating test: SHU 33 models Press **REGULAR WASH** button.

SHU 33 MODELS

To start test program, press and hold both **POWER SCRUB PLUS** and **RINSE & HOLD** program buttons, then turn unit on by pressing **ON/OFF** button. When program buttons are released, lights above them will flash. To end test program, press **ON/OFF** button.

To check program indicator lights (**POWER SCRUB PLUS**, **REGULAR WASH** and **RINSE & HOLD**), press and hold each program button. When **REGULAR WASH** program button is pressed, **CLEAN** light also comes on.

To start testing, press both **POWER SCRUB PLUS** and **RINSE & HOLD** buttons a second time. When testing has ended and a fault was detected, the following indicator lights will be lit:

POWER SCRUB PLUS = Heater fault
REGULAR WASH = Water filling fault (over or under filling)
RINSE & HOLD = NTC (temperature sensor) fault – note circulation motor stops shortly after it started during an NTC fault

To check for heater, high limit or flow switch problems, start testing until heating starts. Using a meter with a current coil, measure current going into dishwasher. If current is ~ 11 A, then heater, high limit and flow switch are OK. If current stays at ~ 1.5-2 A, then heater, high limit or flow switch are faulty.

If water level switch (f1) has failed (opened), **REGULAR WASH** light will come on and unit will continually fill and drain where testing won't be completed. If flow switch (e5) has failed (opened), water won't heat (to 150°F) and water won't stop circulating. If NTC probe (f2/f4) has failed (opened), **RINSE & HOLD** light will come on immediately and testing will end shortly after water has started circulating.

If more than one fault occurs, more than one light will be lit.

SHU 33 models program buttons & indicator lights:

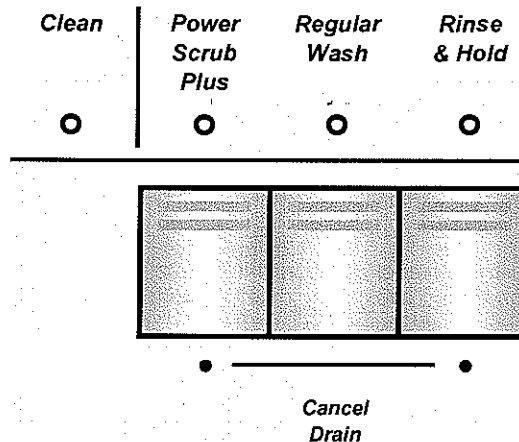

Using Dishwasher Serial Number to find Date of Manufacture

The dishwasher serial number can be used to check if the dishwasher is covered under warranty and to check for product changes.

NOTE: Best way to confirm warranty status is to have customer show paperwork with installation date. Whenever possible, keep a file of customers and installation dates.

NOTE: Serial number is stamped or fastened to inside edge (top or right side) of door and to dishwasher base (behind toe kick).

NOTE: Serial number format (shown in smaller print underneath model number) is shown as FD xxxx xx xxxx, where number means:

FD	XX	XX	XX	XXXX
FD	Shows year dishwasher was built. <i>HINT: Add "20" to this number to find year of manufacture.</i>	Shows month dishwasher was built. <i>HINT: This is the number of the month (from 1-12).</i>	Shows day dishwasher was built.	Shows specific serial number for this dishwasher. <i>HINT: These numbers are sequential for all dishwashers built on each day.</i>
	<ul style="list-style-type: none"> ✓ 77 + 20 = 1997 ✓ 78 + 20 = 1998 ✓ 79 + 20 = 1999 	<ul style="list-style-type: none"> ✓ 01 = January ✓ 02 = February ✓ 12 = December 	<ul style="list-style-type: none"> ✓ 01 = 1st day of month ✓ 30 = 30th day of month 	<ul style="list-style-type: none"> ✓ 0142 = 142nd dishwasher built on particular day of manufacture.

NOTE: To remove toe kick you will need a T20 Torx™ screwdriver.

NOTE: The number after "/" in the model number (e.g. U06) shows an engineering (product) change.