



Fast Track Troubleshooting

Publication # tsRF267AZ Revision 03/30/2011

Models Covered:
 RF267AZBP/XAA
 RF267AZPN/XAA
 RF267AZRS/XAA
 RF267AZWP/XAA

SUBJECT: Parts Change

The interior lighting has been changed from incandescent lighting to LED lighting. The new parts are NOT interchangeable with the old parts. See page 4

IMPORTANT SAFETY NOTICE – “For Technicians only” This service data sheet is intended for use by persons having electrical, electronic, and mechanical experience and knowledge at a level generally considered acceptable in the appliance repair trade. Any attempt to repair a major appliance may result in personal injury and property damage. The manufacturer or seller cannot be responsible, nor assume any liability for injury or damage of any kind arising from the use of this data sheet.

Forced Mode: Press both buttons (Energy Saver– Fridge) *simultaneously* (No sound when both buttons are pressed at the same time) ‘til it beeps and goes blank, 8-12 seconds.



Self Diagnosis: Press both buttons (Energy Saver– Alarm) *simultaneously* (No sound when both buttons are pressed at the same time) ‘til the display quits blinking and beeps, 8-12 seconds, then release and read Fault Codes.

This will also cancel the Fault Mode created by self-diagnosis at power up.

Wait 5 seconds between button pushes

3600RPM	2450RPM	2200RPM	
Press Freezer button one time at the Test Mode to Force Compressor High Speed Run, measure fan and Compressor voltages at main PCB	Press Freezer button a second time to Force Mid Speed Run	Press Freezer button a third time to Force Low Speed Run	Press Freezer button a fourth time to Force Defrost of Fridge & Freezer, measure defrost voltage at main PCB

Condenser Fan Delay function: (Ambient Sensor) Below 60°F
 Condenser-Fan is OFF regardless of the compressor operation.

Sales Mode, No Compressor Operation: Press Energy Saver & Freezer temp buttons simultaneously for 3 sec (you will hear a “Ding Dong”) to remove or put into Sales Mode. When in the Sales Mode the Display will show "OF" "OF": Removing power will not cancel this mode.

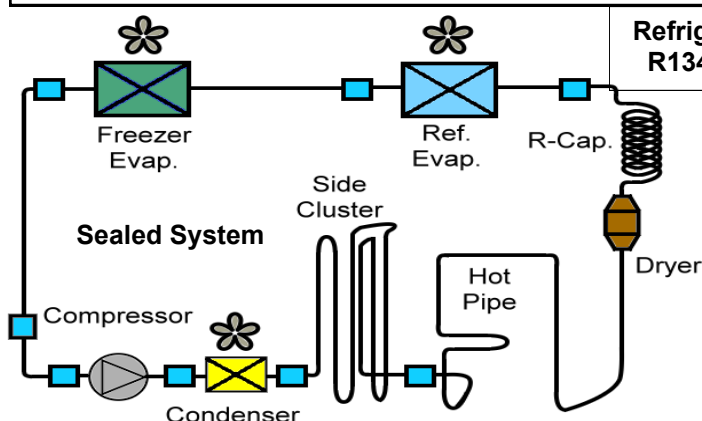

Refrigerant Charge
 R134a 5.64 oz.

Component Value Chart

Component	Resistance	Wattage	Voltage
Freezer Defrost Heater	60Ω	240	120vac
Fridge Defrost Heater	120Ω	120	120vac
French Mullion Heater	1800Ω	8	120vac
Ice Duct Heater	3600Ω	4	120vac
Dispenser Heater	7200Ω	2	120vac
Water Tank Heater	72Ω	2	12vdc
Sensors	2.5kΩ-89kΩ	N/A	1~4.5vdc
Fans	N/A	N/A	7~12vdc

SUPPORT INFORMATION

Training — Plus One <http://my.plus1solutions.net/clientPortals/samsung/>
 Help — GSPN <http://service.samsungportal.com/>
 Samsung Product Support TV <http://support-us.samsung.com/spstv/howto.jsp>
 Customer information videos and chat programs. Programs for Fridges, Laundry, Ranges & D/W

DC FAN MOTORS

Brushless DC Fan motors are used to save energy. The fans operate at two speeds. Fan speed information is read by the Main PCB. If the fan speed exceeds 600 RPM or the speed is too slow, or stopped the fan drive circuit is disabled, After 10 seconds the circuit tries again with 3 seconds of DC voltage If the fan continues this activity for 5 cycles, 10 seconds off 3 seconds on, the fan drive circuit is disabled for 10 minutes.

TO TEST THE FAN CIRCUIT VOLTAGE.

Power off and back on to check the DC voltage to the motor, wait from 10 to 60 seconds for the fan voltage to kick in, and then check fan voltage, the average reading is 9 VDC. If you get 3 seconds of voltage every 10 seconds for the 5 fan power up cycles, then the Main PCB is good.

NOTE: You may need to put unit in FORCED FREEZE mode to activate the fans/compressor.

If the fan blade is blocked by ice, then defrost and check the motor again, after removing power from the unit.

If the evaporator is ice blocked and thus blocking the air flow, the fan will over RPM and is stopped. Remove ice and check the motor again. If everything is clear around the fan blade then the motor would be at fault. Continuous fan errors will be displayed on the front panel display. **PLEASE NOTE:** The door switches control the evaporator fan motors. Have them closed to test the motors. Delay time 10 – 60 seconds.

Heat Release Ice Makers

Heat Release Ice production Explanation

38 minutes after the water fill is complete, the control board will check the temperature of the eject Thermistor, on the Ice Maker Head, if the Thermistor reads a temperature lower than 18.5 degrees for more than 5 seconds, then the ice production process is completed. The Ice maker will harvest if the ice bucket is not sensed as full. If a Fault Mode is detected with the Ice Maker operation, the Ice Maker stops working for 3 hours. Which means, the Ice Maker checks the operation every 3 hours until it works properly.

Heat Release I/M Test Mode

Press and hold the ICE TEST S/W for at least 1.5sec, the harvest function will start. If the ice maker Thermistor is below 0 degrees the Ice maker heater turns on for about 2 minutes. If the temperature exceeds 0 degrees, Ice maker heater turns on for 30 seconds. After the Ice maker heater turns on for 30 seconds, the heater turns off and then Ice maker harvest motor turns on. The motor will rotate in right direction for about 3 minutes, after this, water supply valve is turned on, then the valve is turned off, the test mode is completed. If the above operation is not carried out within 6 minutes, it will go into a fault mode.





















FREEZER TEMPERATURE CONTROL BY THE ICE MAKER

Interior Temperature of the freezer will be set to -14 degrees Fahrenheit until the ice bucket is full. When the ice bucket is full, the freezer will maintain original set temperature. Also, whenever the ice is used, the freezer will again set to -14 degrees Fahrenheit. Selecting "Ice Off" will allow the freezer to be controlled by the set temperature. If water is not hooked up, the freezer will always be at -14 unless "Ice Off" is selected.

Temperature/Resistance/Voltage Chart for Samsung Refrigerators Sensors

Temp.	(Ω)	Volts	Temp.	(Ω)	Volts	Temp.	(Ω)	Volts	Temp.	(Ω)	Volts
-29.2°F	64227	4.326	1.4°F	28021	3.685	32.0°F	13290	2.853	62.6°F	6771	2.019
-27.4°F	61012	4.296	3.2°F	26760	3.64	33.8°F	12749	2.802	64.4°F	6521	1.974
-25.6°F	57977	4.264	5.0°F	25562	3.594	35.6 °F	12233	2.751	66.2°F	6281	1.929
-23.8°F	55112	4.232	6.8°F	24425	3.548	37.4 °F	11741	2.7	68.0°F	6052	1.885
-22.0°F	52406	4.199	8.6°F	23345	3.501	39.2 °F	11271	2.649	69.8°F	5832	1.842
-20.2°F	49848	4.165	10.4°F	22320	3.453	41.0°F	10823	2.599	71.6°F	5621	1.799
-18.4°F	47431	4.129	12.2°F	21345	3.405	42.8°F	10395	2.548	75.2°F	5225	1.716
-16.6°F	45146	4.093	14.0°F	20418	3.356	44.6°F	9986	2.498	77.0°F	5000	1.675
-14.8°F	42984	4.056	15.8°F	19537	3.307	46.4°F	9596	2.449	78.8°F	4861	1.636
-13.0°F	40938	4.018	17.6°F	18698	3.258	48.2°F	9223	2.399	80.6°F	4690	1.596
-11.2°F	39002	3.98	19.4°F	17901	3.208	50.0°F	8867	2.35	86.0°F	4218	1.483
-9.4°F	37169	3.94	21.2°F	17142	3.158	51.8°F	8526	2.301	87.8°F	4072	1.447
-7.6°F	35433	3.899	23.0°F	16419	3.107	53.6°F	8200	2.253	89.6°F	3933	1.412
-5.8°F	33788	3.858	24.8°F	15731	3.057	55.4°F	7888	2.205	91.4°F	3799	1.377
-4.0°F	32230	3.816	26.6°F	15076	3.006	57.2°F	7590	2.158	95.0°F	3547	1.309
-2.2°F	30752	3.773	28.4°F	14452	2.955	59.0°F	7305	2.111	96.8°F	3428	1.277
-0.4°F	29350	3.729	30.2°F	13857	2.904	60.8°F	7032	2.064	100.4°F	3204	1.213

Samsung 'Refrigerator' Diagnostic Code Quick Guide

Error Items	LED	TROUBLE	TESTING
I/M-SENSOR (R on Twin I/M units)		Ice Maker Sensor Error- open or short-circuit, connector failure. Cause is also a temperature reading > 122° or < -58 ° F	The voltage at MAIN PCB Sensor between 4.5V~1.0V
R-SENSOR		Refrigerator Room Sensor Error- open or short-circuit, connector failure. Cause is also a temperature reading > 122° or < -58 ° F.	The voltage at MAIN PCB Sensor between 4.5V~1.0V
DEFROST SENSOR OF R ROOM		Ref. Defrost Sensor Error- open or short-circuit, connector failure. Cause is also a temperature reading > 122° or < -58 ° F	The voltage at MAIN PCB Sensor between 4.5V~1.0V
R-FAN ERROR		This error indicates the Refrigerator Evap Fan is not spinning at the correct RPM or the fan feedback line is open.	Fan voltage at MAIN PCB shall be between 7V~12V
I/M FUNCTION ERROR(R on Twin I/M)		This error indicates the Ice tray has not returned to level after an ice harvest. The error is displayed after three failed attempts.	Replace I/M
R-DEFROSTING ERROR		Refrigerator Room defrost heater- open or short-circuit, connector failure, or defective temperature fuse/bi-metal. Defrost on over 80 minutes	Disconnect defrost connector from PCB, check resistance
PANTRY-DAMPER-HEATER ERROR		Sensor system in Pantry Room errors	Disconnect heater connector from PCB, check resistance
PANTRY-SENSOR ERROR		CR Room Sensor Error- This can be an open or short-circuit, contact failure. Cause is also a temperature reading > 122° or < -58 ° F.	The voltage of MAIN PCB Sensor between 4.5V~1.0V
WATER HEATER ERROR		Error is displayed when the water reservoir tank heater is open or shorted	Disconnect heater connector from PCB, check resistance
EXT-SENSOR		Ambient Temp. Sensor Error- open or short-circuit, connector failure. Cause is also a temperature reading > 122° or < -58 ° F	The voltage at MAIN PCB Sensor between 4.5V~1.0V
F-SENSOR		Freezer Compartment Sensor Error- open or short-circuit, connector failure. Cause is also a temperature reading > 122° or < -58 ° F	The voltage at MAIN PCB Sensor between 4.5V~1.0V
F-DEF-SENSOR		Freezer Room Defrost Sensor Error- open or short-circuit, connector failure. Cause is also a temperature reading > 122° or < -58 ° F	The voltage at MAIN PCB Sensor between 4.5V~1.0V
F-FAN ERROR		This error indicates the Freezer Evap. Fan is not spinning at the correct RPM or the fan feedback line is open.	Fan voltage at MAIN PCB shall be between 7V~12V
C-FAN ERROR		This error indicates the Condenser Fan is not spinning at the correct RPM or the fan feedback line is open.	Fan voltage at MAIN PCB shall be between 7V~12V
FRENCH DOOR ICE ROOM SENSOR		Ice Room Sensor Error- open or short-circuit, connector failure. Cause is also a temperature reading > 122° or < -58 ° F	The voltage at MAIN PCB Sensor between 4.5V~1.0V
F-DEFROSTING ERROR		Freezer defrosting heater- open or short-circuit, connector failure, or defective temperature fuse/bi-metal. Defrost on for over 80 minutes	Disconnect defrost connector from PCB, check resistance
FRENCH DOOR ICE ROOM FAN ERROR		This error indicates the Ice Room Compartment Evap. Fan is not spinning at the correct RPM or the fan feedback line is open.	Fan voltage at MAIN PCB shall be between 7V~12V
Uart ERROR COMMUNICATION		This error is not applicable, if the error is detected during diagnostic testing please ignore it.	No Repair Necessary
L↔M ERROR COMMUNICATION		Communication error within the Main PCB	Replace main PCB
P↔M ERROR COMMUNICATION		Communication between the Main PCB and Keypad	Check wiring in door & cabinet, Panel PCB, Main PCB

SERVICE BULLETIN
 PRODUCT: Refrigerator
 BULLETIN NUMBER:
 ASC20100714001
 DATE:
 07/14/2010
**Please review before ordering
 any parts.**

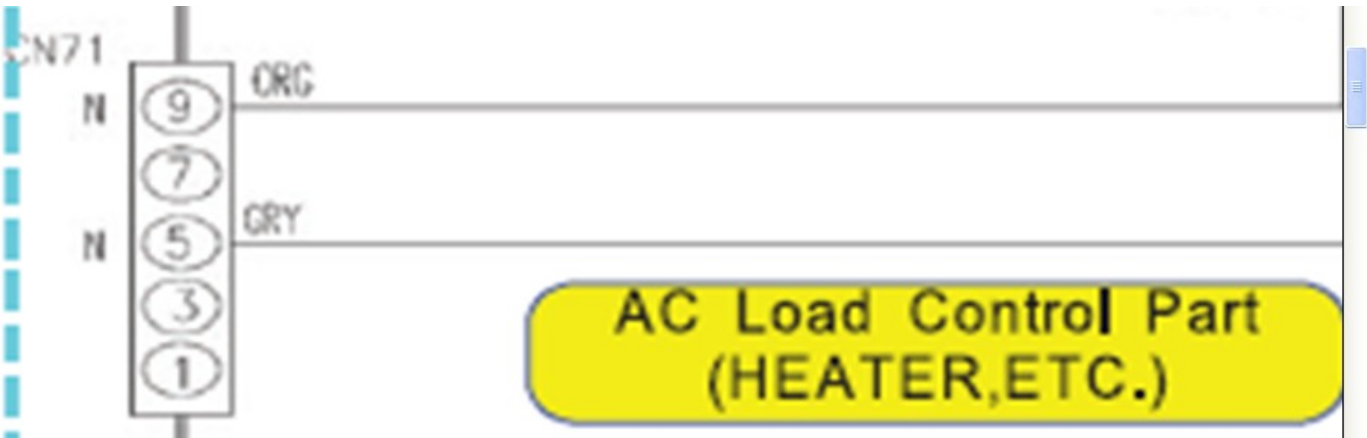
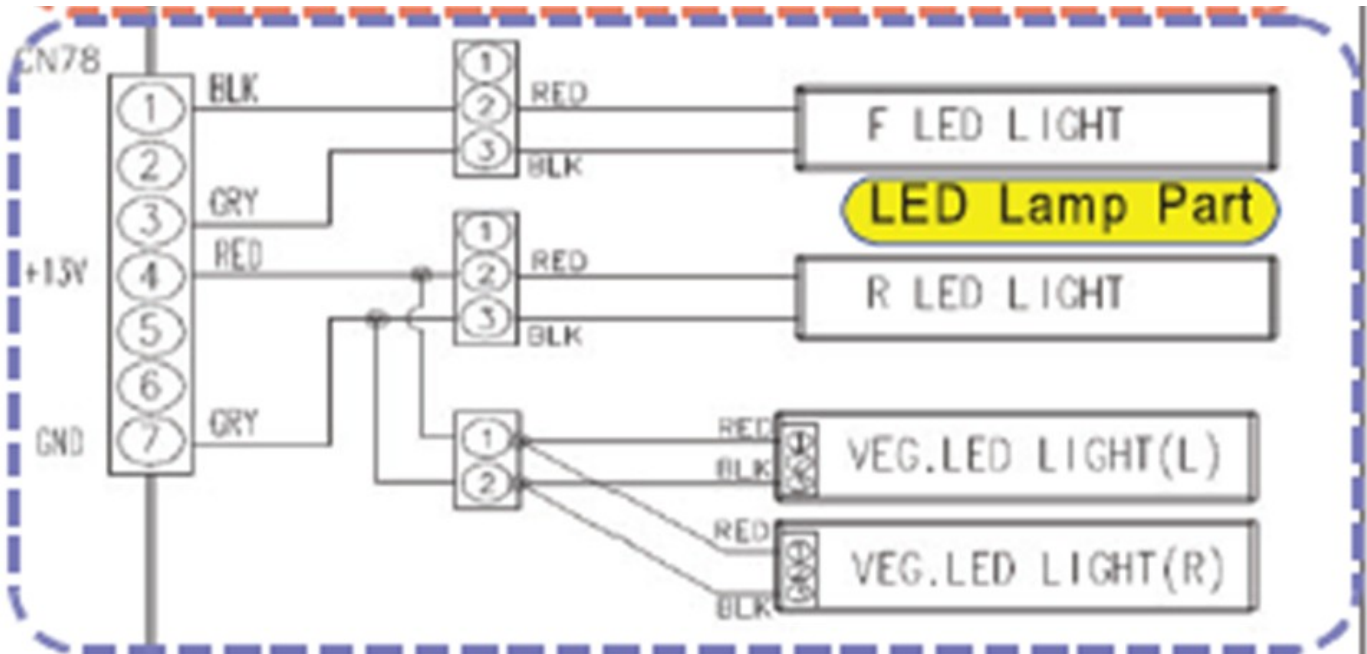

CN78
 1-3 Fz LED (Blk-Gry)
 4-7-FF LED (Red-Gry)

CN71 All 120vac
 5-N (Gry)
 9-Def Htr Common (Org)

CN= Connector # for measuring voltages; () means go to connector #, pin # shown in () for voltage common.
CN30 Sensors & Switches ← Component Name
4-(CN76-1) F Def Sensor (Org-Gry) 2.3~4.2vdc ← Voltage on operating component
 Pin #s & wire colors on each connector to measure voltages

Key To Read PCB Layout

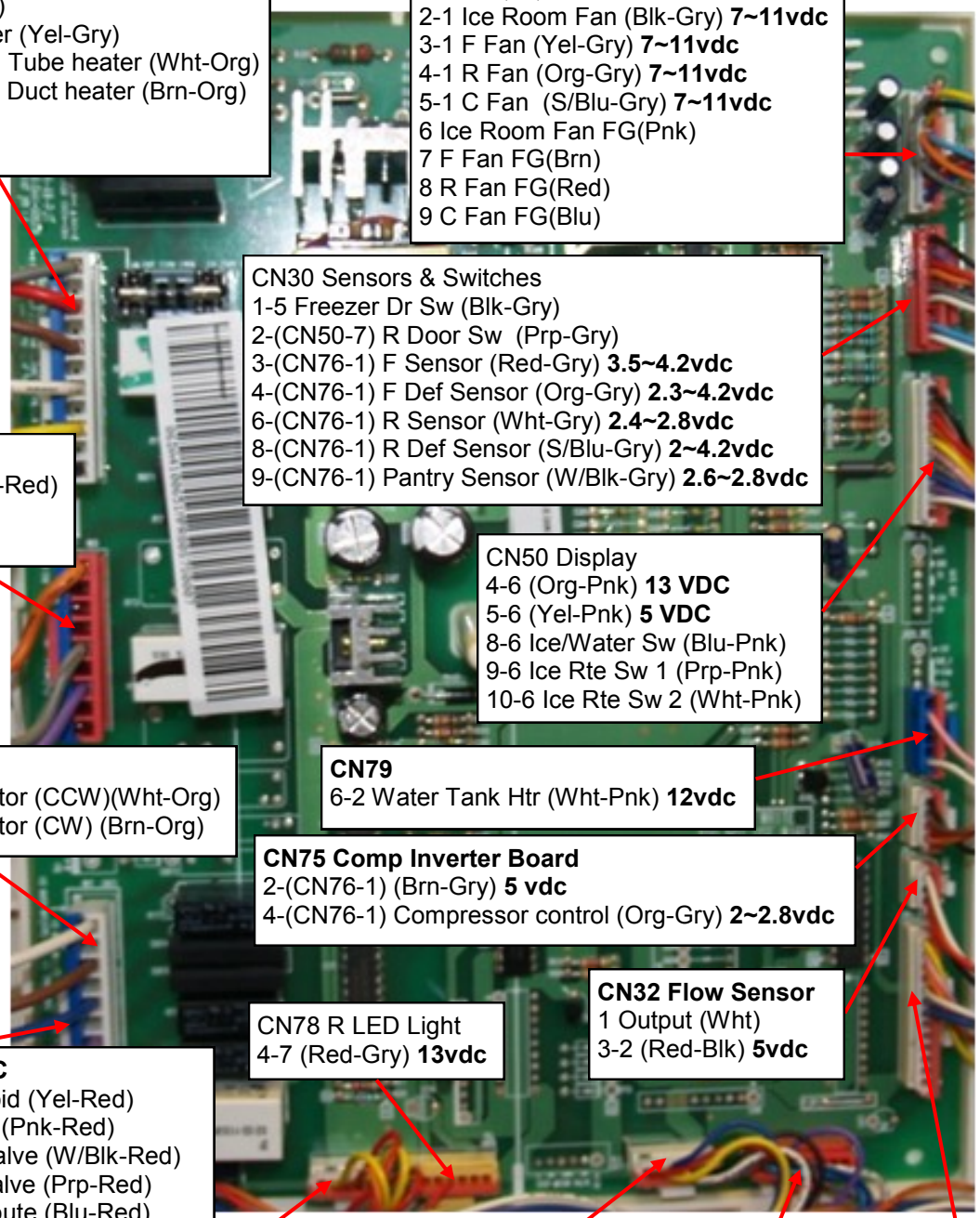

CN70 120VAC
 1-11 I/M Heater (Blk-Gry)
 3-11 French / Disp Heater (Yel-Gry)
 5-(CN71-9) R Defrost/Fill Tube heater (Wht-Org)
 7-(CN71-9) F Defrost/Ice Duct heater (Brn-Org)
 9- L1 (Red)
 11- N (Gry)

CN76 F, R, C Fans
 2-1 Ice Room Fan (Blk-Gry) 7~11vdc
 3-1 F Fan (Yel-Gry) 7~11vdc
 4-1 R Fan (Org-Gry) 7~11vdc
 5-1 C Fan (S/Blu-Gry) 7~11vdc
 6 Ice Room Fan FG(Pnk)
 7 F Fan FG(Brn)
 8 R Fan FG(Red)
 9 C Fan FG(Blu)

CN30 Sensors & Switches
 1-5 Freezer Dr Sw (Blk-Gry)
 2-(CN50-7) R Door Sw (Prp-Gry)
 3-(CN76-1) F Sensor (Red-Gry) 3.5~4.2vdc
 4-(CN76-1) F Def Sensor (Org-Gry) 2.3~4.2vdc
 6-(CN76-1) R Sensor (Wht-Gry) 2.4~2.8vdc
 8-(CN76-1) R Def Sensor (S/Blu-Gry) 2~4.2vdc
 9-(CN76-1) Pantry Sensor (W/Blk-Gry) 2.6~2.8vdc

CN71 120VAC
 3-(CN70-1) F Lamp (Prp-Red)
 5 Common N (Gry)
 9 Heater Common (Org)

CN50 Display
 4-6 (Org-Pnk) 13 VDC
 5-6 (Yel-Pnk) 5 VDC
 8-6 Ice/Water Sw (Blu-Pnk)
 9-6 Ice Rte Sw 1 (Prp-Pnk)
 10-6 Ice Rte Sw 2 (Wht-Pnk)

CN79
 6-2 Water Tank Htr (Wht-Pnk) 12vdc

CN75 Comp Inverter Board
 2-(CN76-1) (Brn-Gry) 5 vdc
 4-(CN76-1) Compressor control (Org-Gry) 2~2.8vdc

CN73 120VAC
 13-(CN70-9)Ice Maker Motor (CCW)(Wht-Org)
 11-(CN70-9)Ice Maker Motor (CW) (Brn-Org)

CN32 Flow Sensor
 1 Output (Wht)
 3-2 (Red-Blk) 5vdc

CN78 R LED Light
 4-7 (Red-Gry) 13vdc

CN74 A/C Load 120VAC
 1-(CN70-9) Cube Solenoid (Yel-Red)
 3-(CN70-9) Auger Motor (Pnk-Red)
 5-(CN70-9) Dispenser Valve (W/Blk-Red)
 7-(CN70-9) Ice Maker Valve (Prp-Red)
 9-(CN70-9) Ice Cover Route (Blu-Red)

CN31 Sensor
 1-4 Ambient Sensor (Yel-Yel) 1.2~2 vdc
 2-(CN90-8) I/M Frz (Red-S/Blu) 5VDC
 3-(CN76-1) Ice Room Sensor (Org-Gry) 3~3.8vdc

CN51 Pantry Room
 7-5 (Blu-Wht) 13vdc

CN90 Ice Maker
 4-8 Eject Sensor (Wht-S/Blu) 2.3~3.3vdc
 5-8 Test Sw (Gry-S/Blu) 5vdc
 6 Full Hall IC (Blu)
 7 Horiz Hall IC (Prp)
 8 VDC Ground (S/Blu)

CN91 Pantry Room Damper
 1-2 Damper Heater (Blk-Brn) 12vdc
 3-4 Damper Motor (Wht-Blu)
 5-6 Damper Motor (Yel-Red)

**EARLY PRODUCTION
 RF267AZ**

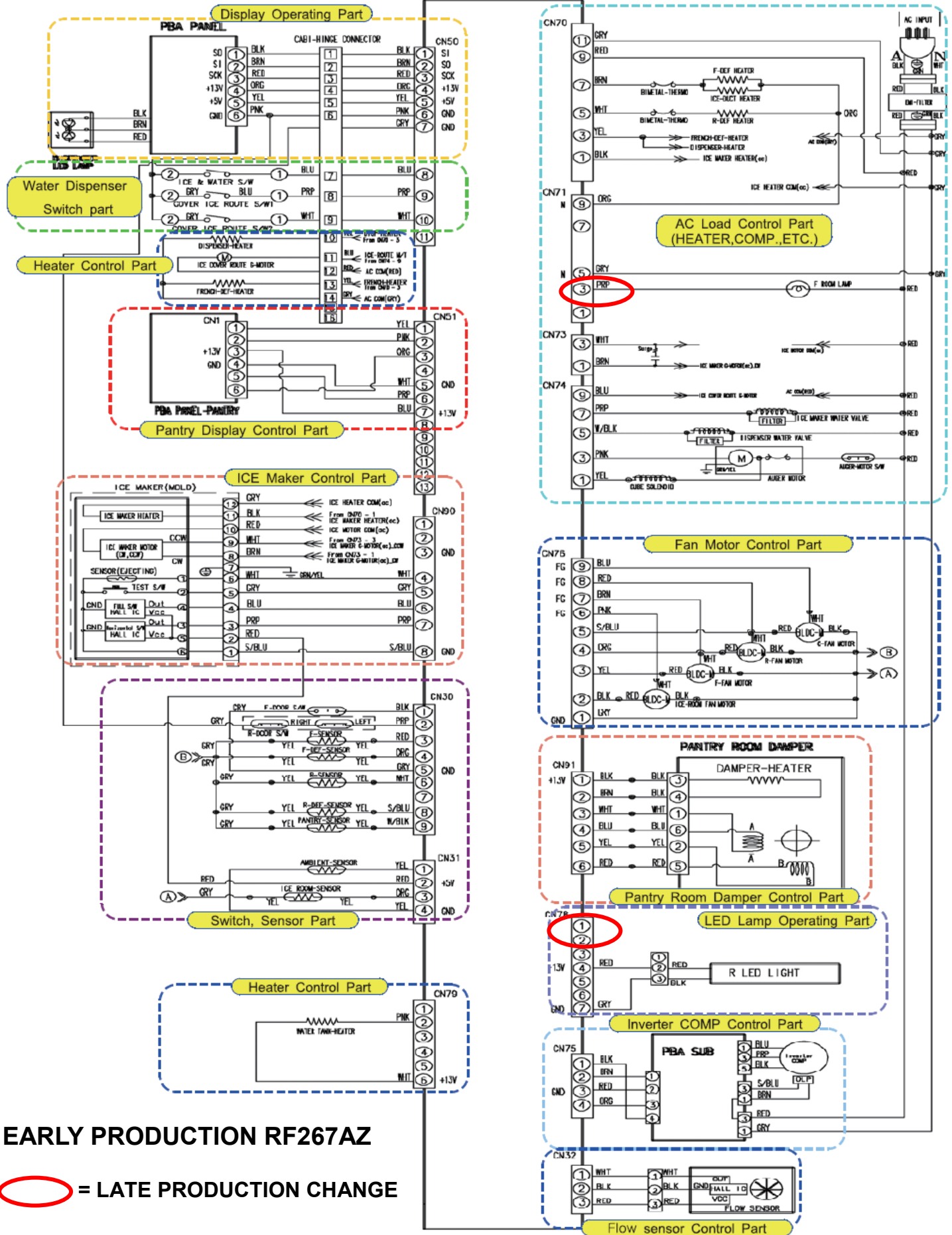

EARLY PRODUCTION RF267AZ

 = LATE PRODUCTION CHANGE

Compressor Operation Testing

TEST BEFORE INTERPRETING LED BLINKING FREQUENCY

Compressor not running

1. Activate Forced Compressor Operation, wait 2 minutes (in case of high head pressure)
2. If compressor doesn't start, check CN75 for 2~2.8vdc (if not there replace Main PCB)
3. Check for 120vac to inverter PCB CN02 L-N
4. If voltage is OK, remove power, disconnect CN03 (Inverter PCB) and check resistance to the windings. Aproxametly10 ohms. If not correct , inspect wire harness, if OK replace compressor.
5. Disconnect CN02 (SMPS PCB), check resistance to Overload , if open replace overload.

CN75 To Comp Inverter Board
4-(CN76-1) Compressor control (Org-Gry) 2~2.8vdc

CN04 Compressor Control
2- (CN76-1) 5vdc (Brn-Gry)
4- (CN76-1) Comp Signal (Org)

CN03 Compressor Windings
1 Compressor (Blue)
3 Compressor (Prp)
5 Compressor (Wht)

CN02 Overload & A/C Line
1 OLP (Brn)
3 OLP (S/Blu)
3 L (Blk)
1 N (Red)

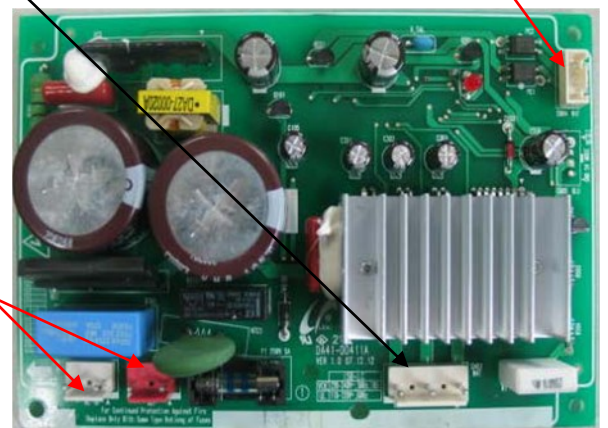
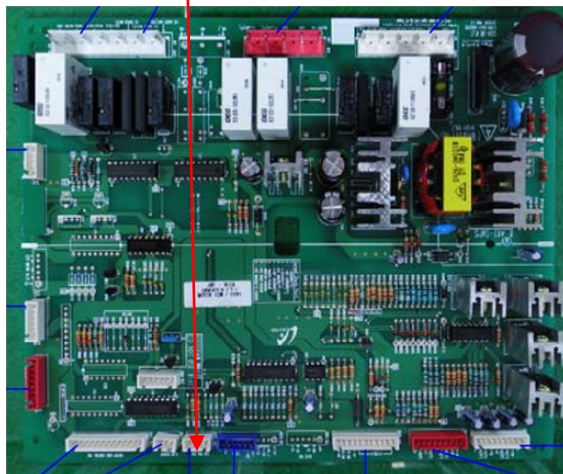

Protection Functions	LED Blinking Frequency	Test	Replace
Starting Failure	●	Check the Inverter PCB & Comp Relay Connectors	Connectors OK,replace Inverter PCB, if same, replace compressor
SPM Fault	● ●	If blinking after reset,	Check System for restriction & refrigerant, if OK replace Inverter, if same, replace compressor
Detecting Position Failure	● ● ●	Check Inverter Connectors,	Connectors measure OK, replace compressor, if same, replace Inverter PCB
Motor Locked	● ● ● ●	Compressor Locking	Compressor
Low Voltage	● ● ● ● ●	Compressor Locking, check input voltage	Replace Inverter PCB, if same, replace Compressor
Over Voltage	● ● ● ● ● ●	Compressor Locking, check input voltage	Replace Inverter PCB, if same, replace Compressor