



Fast Track Troubleshooting

Publication # tsRF267AA Revision Date 03/30/2011

Models Covered:
RF267AA/XAA**
French Door Refrigeration

NOTICE:
RF267AA 01/09**
 Parts Change: Refer to bulletin.
 All Water Tank Parts & Door
 Dispenser Ass'y Parts

IMPORTANT SAFETY NOTICE – “For Technicians Only” This service data sheet is intended for use by persons having electrical, electronic, and mechanical experience and knowledge at a level generally considered acceptable in the appliance repair trade. Any attempt to repair a major appliance may result in personal injury and property damage. The manufacturer or seller cannot be responsible, nor assume any liability for injury or damage of any kind arising from the use of this data sheet.

Self Diagnosis: Press both buttons (Energy Saver– Alarm) *simultaneously* (No sound when both buttons are pressed at the same time) 'til the display quits blinking and beeps, 8-12 seconds, then release and read Fault Codes. This will also cancel the Fault Mode created by self-diagnosis at power up.

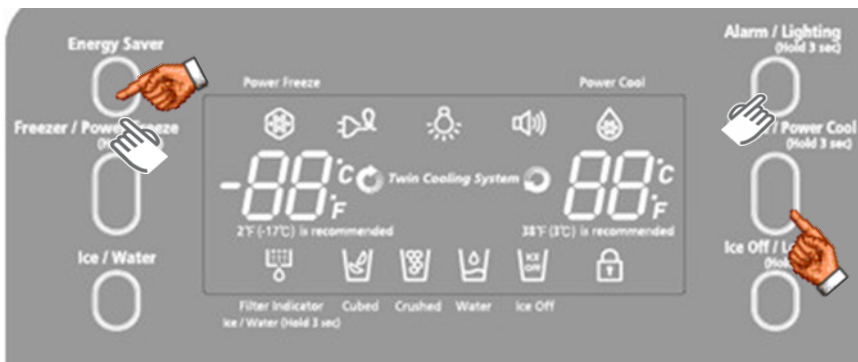

Forced Mode: Press both buttons (Energy Saver – Fridge) *simultaneously* (No sound when both buttons are pressed at the same time) 'til it beeps and goes blank, 8-12 seconds

Wait 5 seconds between button pushes

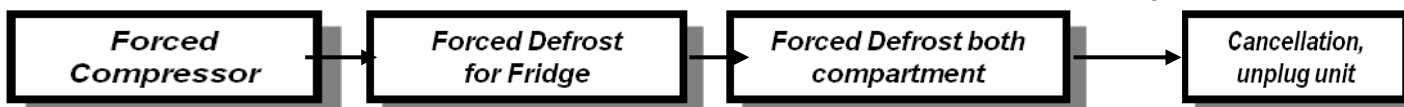

Press Freezer button one time at the Test Mode to Force Compressor Run, measure fan and compressor voltages at main PCB

Press Freezer button a second time to Force Defrost of Fridge, measure defrost voltage at main PCB

Press Freezer button a third time to Force Defrost for Fridge & Freezer, measure defrost voltages at main PCB

Sales Mode, No Compressor Operation: Press Energy Saver & Freezer temp buttons simultaneously for 3 sec (you will hear a “Ding Dong”) to remove or put into Sales Mode. When in the Sales Mode the Display will show "OF" "OF": Removing power will not cancel this mode.

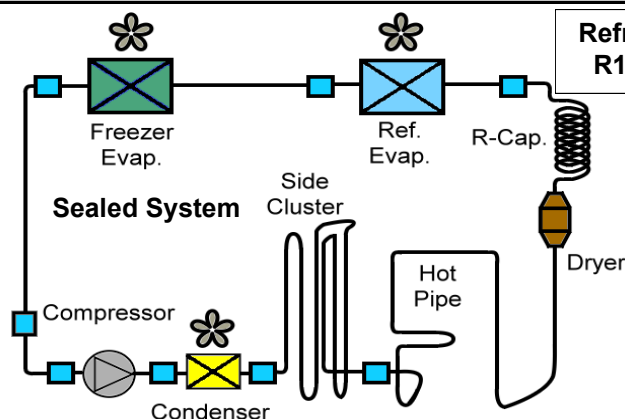

Refrigerant Charge
R134a 5.64 oz.

Component Value Chart

Component	Resistance	Wattage	Voltage
Freezer Defrost Heater	60Ω	240	120vac
Fridge Defrost Heater	120Ω	120	120vac
French Mullion Heater	1800Ω	8	120vac
Ice Duct Heater	3600Ω	4	120vac
Dispenser Heater	7200Ω	2	120vac
Water Tank Heater	72Ω	2	12vdc
Sensors	2.5kΩ-89kΩ	N/A	1~4.5vdc
Fans	N/A	N/A	7~12vdc

SUPPORT INFORMATION

Training — Plus One <http://my.plus1solutions.net/clientPortals/samsung/>
 Help — GSPN <http://service.samsungportal.com/>
 Samsung Product Support TV <http://support-us.samsung.com/spstv/howto.jsp>
 Customer information videos and chat programs. Programs for Fridges, Laundry, Ranges & D/W

DC FAN MOTORS

Brushless DC Fan motors are used to save energy. The fans operate at two speeds. Fan speed information is read by the Main PCB. If the fan speed exceeds 600 RPM or the speed is too slow, or stopped the fan drive circuit is disabled, After 10 seconds the circuit tries again with 3 seconds of DC voltage. If the fan continues this activity for 5 cycles, 10 seconds off 3 seconds on, the fan drive circuit is disabled for 10 minutes.

TO TEST THE FAN CIRCUIT VOLTAGE.

Power off and back on to check the DC voltage to the motor, wait from 10 to 60 seconds for the fan voltage to kick in, and then check fan voltage, the average reading is 9 VDC. If you get 3 seconds of voltage every 10 seconds for the 5 fan power up cycles, then the Main PCB is good.

NOTE: You may need to put unit in FORCED FREEZE mode to activate the fans/compressor.

If the fan blade is blocked by ice, then defrost and check the motor again, after removing power from the unit.

If the evaporator is ice blocked and thus blocking the air flow, the fan will over RPM and will be stopped. Remove ice and check the motor again. If everything is clear around the fan blade then the motor would be at fault. Continuous fan errors will be displayed on the front panel display. **PLEASE NOTE:** The door switches control the evaporator fan motors. Have them closed to test the motors. Delay time 10 – 60 seconds.

Heat Release Ice Makers

Heat Release Ice Production Explanation

38 minutes after the water fill is complete, the control board will check the temperature of the eject Thermistor, on the Ice Maker Head, if the Thermistor reads a temperature lower than 18.5 degrees for more than 5 seconds, then the ice production process is completed. The Ice maker will harvest if the ice bucket is not sensed as full. If a Fault Mode is detected with the Ice Maker operation, the Ice Maker stops working for 3 hours. Which means, the Ice Maker checks the operation every 3 hours until it works properly.

Heat Release I/M Test Mode

Press and hold the ICE TEST S/W for at least 1.5sec, the harvest function will start. If the ice maker Thermistor is below 0 degrees the Ice maker heater turns on for about 2 minutes. If the temperature exceeds 0 degrees, ice maker heater turns on for 30 seconds. After the ice maker heater turns on for 30 seconds, the heater turns off and then Ice maker harvest motor turns on. The motor will rotate in right direction for about 3 minutes, after this, water supply valve is turned on, then the valve is turned off, the test mode is completed. If the above operation is not carried out within 6 minutes, it will go into a fault mode.





















FREEZER TEMPERATURE CONTROL BY THE ICE MAKER

Interior Temperature of the freezer will be set to -14 degrees Fahrenheit until the ice bucket is full. When the ice bucket is full, the freezer will maintain original set temperature. Also, whenever the ice is used, the freezer will again set to -14 degrees Fahrenheit. Selecting "Ice Off" will allow the freezer to be controlled by the set temperature. If water is not hooked up, the freezer will always be at -14 unless "Ice Off" is selected.

Temperature/Resistance/Voltage Chart for Samsung Refrigerators Sensors

Temp.	(Ω)	Volts	Temp.	(Ω)	Volts	Temp.	(Ω)	Volts	Temp.	(Ω)	Volts
-29.2°F	64227	4.326	1.4°F	28021	3.685	32.0°F	13290	2.853	62.6°F	6771	2.019
-27.4°F	61012	4.296	3.2°F	26760	3.64	33.8°F	12749	2.802	64.4°F	6521	1.974
-25.6°F	57977	4.264	5.0°F	25562	3.594	35.6 °F	12233	2.751	66.2°F	6281	1.929
-23.8°F	55112	4.232	6.8°F	24425	3.548	37.4 °F	11741	2.7	68.0°F	6052	1.885
-22.0°F	52406	4.199	8.6°F	23345	3.501	39.2 °F	11271	2.649	69.8°F	5832	1.842
-20.2°F	49848	4.165	10.4°F	22320	3.453	41.0°F	10823	2.599	71.6°F	5621	1.799
-18.4°F	47431	4.129	12.2°F	21345	3.405	42.8°F	10395	2.548	75.2°F	5225	1.716
-16.6°F	45146	4.093	14.0°F	20418	3.356	44.6°F	9986	2.498	77.0°F	5000	1.675
-14.8°F	42984	4.056	15.8°F	19537	3.307	46.4°F	9596	2.449	78.8°F	4861	1.636
-13.0°F	40938	4.018	17.6°F	18698	3.258	48.2°F	9223	2.399	80.6°F	4690	1.596
-11.2°F	39002	3.98	19.4°F	17901	3.208	50.0°F	8867	2.35	86.0°F	4218	1.483
-9.4°F	37169	3.94	21.2°F	17142	3.158	51.8°F	8526	2.301	87.8°F	4072	1.447
-7.6°F	35433	3.899	23.0°F	16419	3.107	53.6°F	8200	2.253	89.6°F	3933	1.412
-5.8°F	33788	3.858	24.8°F	15731	3.057	55.4°F	7888	2.205	91.4°F	3799	1.377
-4.0°F	32230	3.816	26.6°F	15076	3.006	57.2°F	7590	2.158	95.0°F	3547	1.309
-2.2°F	30752	3.773	28.4°F	14452	2.955	59.0°F	7305	2.111	96.8°F	3428	1.277
-0.4°F	29350	3.729	30.2°F	13857	2.904	60.8°F	7032	2.064	100.4°F	3204	1.213

Samsung 'Refrigerator' Diagnostic Code Quick Guide

Error Items	LED	TROUBLE	TESTING
I/M-SENSOR (R on Twin I/M units)		Ice Maker Sensor Error- open or short-circuit, connector failure. Cause is also a temperature reading > 122° or < -58 ° F	The voltage at MAIN PCB Sensor between 4.5V~1.0V
R-SENSOR		Refrigerator Room Sensor Error- open or short-circuit, connector failure. Cause is also a temperature reading > 122° or < -58 ° F.	The voltage at MAIN PCB Sensor between 4.5V~1.0V
DEFROST SENSOR OF R ROOM		Ref. Defrost Sensor Error- open or short-circuit, connector failure. Cause is also a temperature reading > 122° or < -58 ° F	The voltage at MAIN PCB Sensor between 4.5V~1.0V
R-FAN ERROR		This error indicates the Refrigerator Evap Fan is not spinning at the correct RPM or the fan feedback line is open.	Fan voltage at MAIN PCB shall be between 7V~12V
I/M FUNCTION ERROR(R on Twin I/M)		This error indicates the Ice tray has not returned to level after an ice harvest. The error is displayed after three failed attempts.	Replace I/M
R-DEFROSTING ERROR		Refrigerator Room defrost heater- open or short-circuit, connector failure, or defective temperature fuse/bi-metal. Defrost on over 80 minutes	Disconnect defrost connector from PCB, check resistance
PANTRY-DAMPER-HEATER ERROR		Sensor system in Pantry Room errors	Disconnect heater connector from PCB, check resistance
PANTRY-SENSOR ERROR		CR Room Sensor Error- This can be an open or short-circuit, contact failure. Cause is also a temperature reading > 122° or < -58 ° F.	The voltage of MAIN PCB Sensor between 4.5V~1.0V
WATER HEATER ERROR		Error is displayed when the water reservoir tank heater is open or shorted	Disconnect heater connector from PCB, check resistance
EXT-SENSOR		Ambient Temp. Sensor Error- open or short-circuit, connector failure. Cause is also a temperature reading > 122° or < -58 ° F	The voltage at MAIN PCB Sensor between 4.5V~1.0V
F-SENSOR		Freezer Compartment Sensor Error- open or short-circuit, connector failure. Cause is also a temperature reading > 122° or < -58 ° F	The voltage at MAIN PCB Sensor between 4.5V~1.0V
F-DEF-SENSOR		Freezer Room Defrost Sensor Error- open or short-circuit, connector failure. Cause is also a temperature reading > 122° or < -58 ° F	The voltage at MAIN PCB Sensor between 4.5V~1.0V
F-FAN ERROR		This error indicates the Freezer Evap. Fan is not spinning at the correct RPM or the fan feedback line is open.	Fan voltage at MAIN PCB shall be between 7V~12V
C-FAN ERROR		This error indicates the Condenser Fan is not spinning at the correct RPM or the fan feedback line is open.	Fan voltage at MAIN PCB shall be between 7V~12V
FRENCH DOOR ICE ROOM SENSOR		Ice Room Sensor Error- open or short-circuit, connector failure. Cause is also a temperature reading > 122° or < -58 ° F	The voltage at MAIN PCB Sensor between 4.5V~1.0V
F-DEFROSTING ERROR		Freezer defrosting heater- open or short-circuit, connector failure, or defective temperature fuse/bi-metal. Defrost on for over 80 minutes	Disconnect defrost connector from PCB, check resistance
FRENCH DOOR ICE ROOM FAN ERROR		This error indicates the Ice Room Compartment Evap. Fan is not spinning at the correct RPM or the fan feedback line is open.	Fan voltage at MAIN PCB shall be between 7V~12V
Uart ERROR COMMUNICATION		This error is not applicable, if the error is detected during diagnostic testing please ignore it.	No Repair Necessary
L↔M ERROR COMMUNICATION		Communication error within the Main PCB	Replace main PCB
P↔M ERROR COMMUNICATION		Communication between the Main PCB and Keypad	Check wiring in door & cabinet, Panel PCB, Main PCB

CN= Connector # for measuring voltages; () means go to connector #, pin # shown in () for voltage common.

CN30 Sensors & Switches Component Name

4-(CN76-1) F Def Sensor (Org-Gry) 2.3~4.2vdc

Pin #s & wire colors on each connector to measure voltages Voltage on operating component

Key To Read PCB Layout

CN73 A/C Load 120vac
 1-(CN70-1) Cube Solenoid (Yel-Red)
 3-(CN70-1) Auger Motor (Pnk-Red)
 5-(CN70-1) Dispenser Valve (W/Blk-Red)
 7-(CN70-1) Ice Maker Valve (Prp-Red)
 9-(CN70-1) Ice Cover Route (Brn-Red)

CN71 120vac
 1-(CN70-1) R Lamps (Blu-Red)
 3-(CN70-1) F Lamp (Prp-Red)
 5 Common N (Gry)
 7-(CN70-1) Comp (S/Blu-Red)
 9 Heater Common (Org)

CN70 120vac
 1 Common Line L (Red)
 3-(CN71-5) Disp Heater (Blk-Gry)
 5-(CN71-5) French Heater (Yel-Gry)
 7-(CN71-9) R Defrost (Wht-Org)
 9-(CN71-9) F Defrost (Brn-Org)

CN10 Low Volt Pwr
 1-3 **5VDC** (Red-Blk)
 5-3 **12 VDC** (Yel-Blk)

CN78
 4-5 Water Tank Htr (Brn-Blk) **12vdc**
 6,7,8 Pantry Disp
 9-11 (Blu-Wht) **12vdc**
 10-11 Sw input (Prp-Wht) **5vdc**

CN50 Display
 4-6 (Org-Pnk) **13vdc**
 5-6 (Yel-Pnk) **5vdc**
 8-6 Ice/Water Sw (Blu-Pnk)
 9-6 Ice Rte Sw 1 (Prp-Pnk)
 10-6 Ice Rte Sw 2 (Wht-Pnk)

CN72 120vac
 1-(CN70-1)Ice Maker Motor (Brn)
 3-(CN70-1)Ice Maker Heater (Wht)

CN91 Pantry Room Damper
 1-2 Damper Heater (Blk-Brn) **12vdc**
 3-4 Damper Motor (Wht-Blu)
 5-6 Damper Motor (Yel-Red)

CN76 Ice Room
 1-(CN75-1) Ice Room Fan (Blk-Gry) **7~11vdc**
 2 Ice Fan FG (Brn)

CN30 Sensors & Switches
 1-5 Freezer Dr Sw (Blk-Gry)
 2-(CN50-7) R Door Sw (Prp-Gry)
 3-(CN75-1) F Sensor (Red-Gry) **3.5~4.2vdc**
 4-(CN75-1) F Def Sensor (Org-Gry) **2.3~4.2vdc**
 6-(CN75-1) R Sensor (Wht-Gry) **2.4~2.8vdc**
 7-(CN75-1) R Def Sensor (S/Blu-Gry) **2~4.2vdc**
 8-9 Pantry Sensor (W/Blk- Gry) **2.6~2.8vdc**

CN75 F, R, C Fans
 2-1 F Fan (Yel-Gry) **7~11vdc**
 3-1 R Fan (Org-Gry) **7~11vdc**
 4-1 C Fan (S/Blu-Gry) **7~11vdc**
 5 F Fan FG (Blk)
 6 R Fan FG(Brn)
 7 C Fan FG(Red)

CN32 Sensor
 1-4 Ambient Sensor (Wht-Wht) **1.2~2 vdc**
 2-(CN75-1) **5VDC** to I/M (Red-Gry)
 3-(CN75-1) Ice Room Sensor (Org-Gry) **3~3.8vdc**

CN90 Ice Maker
 4-8 Eject Sensor (Wht-S/Blu) **2.3~3.3vdc**
 5-8 Test Sw (Gry-S/Blu) **5vdc**
 6 Full Sw (Blu)
 7 Horiz Sw (Prp)
 8 VDC Ground (S/Blu)

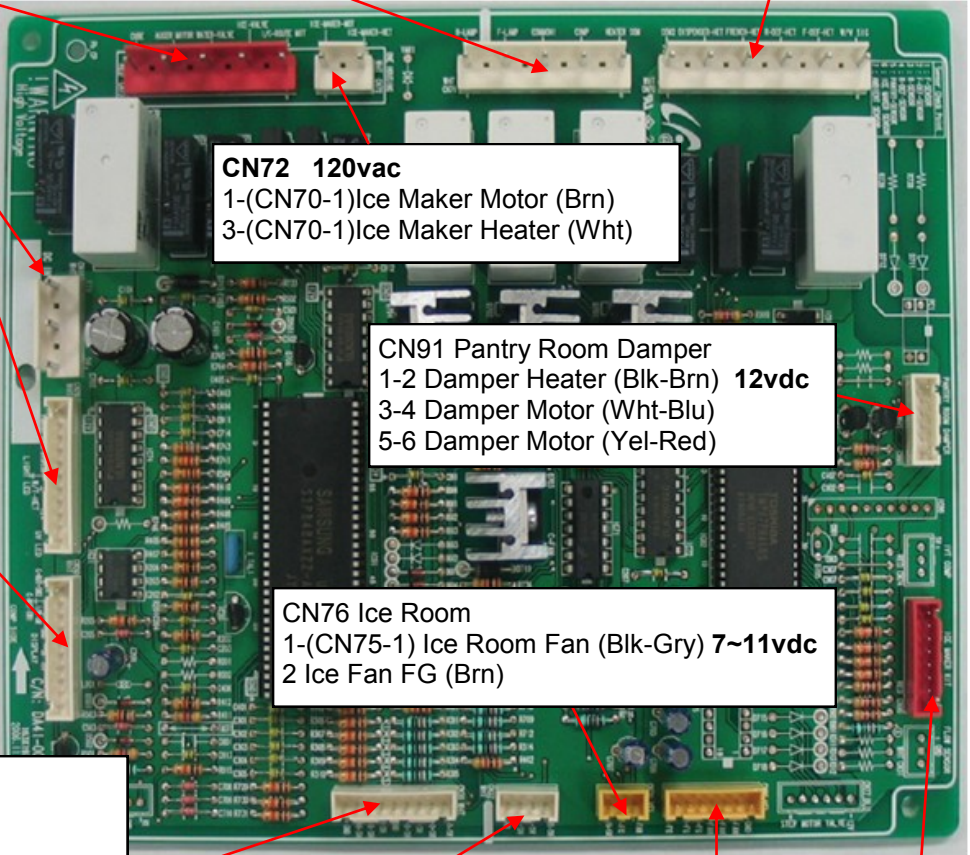

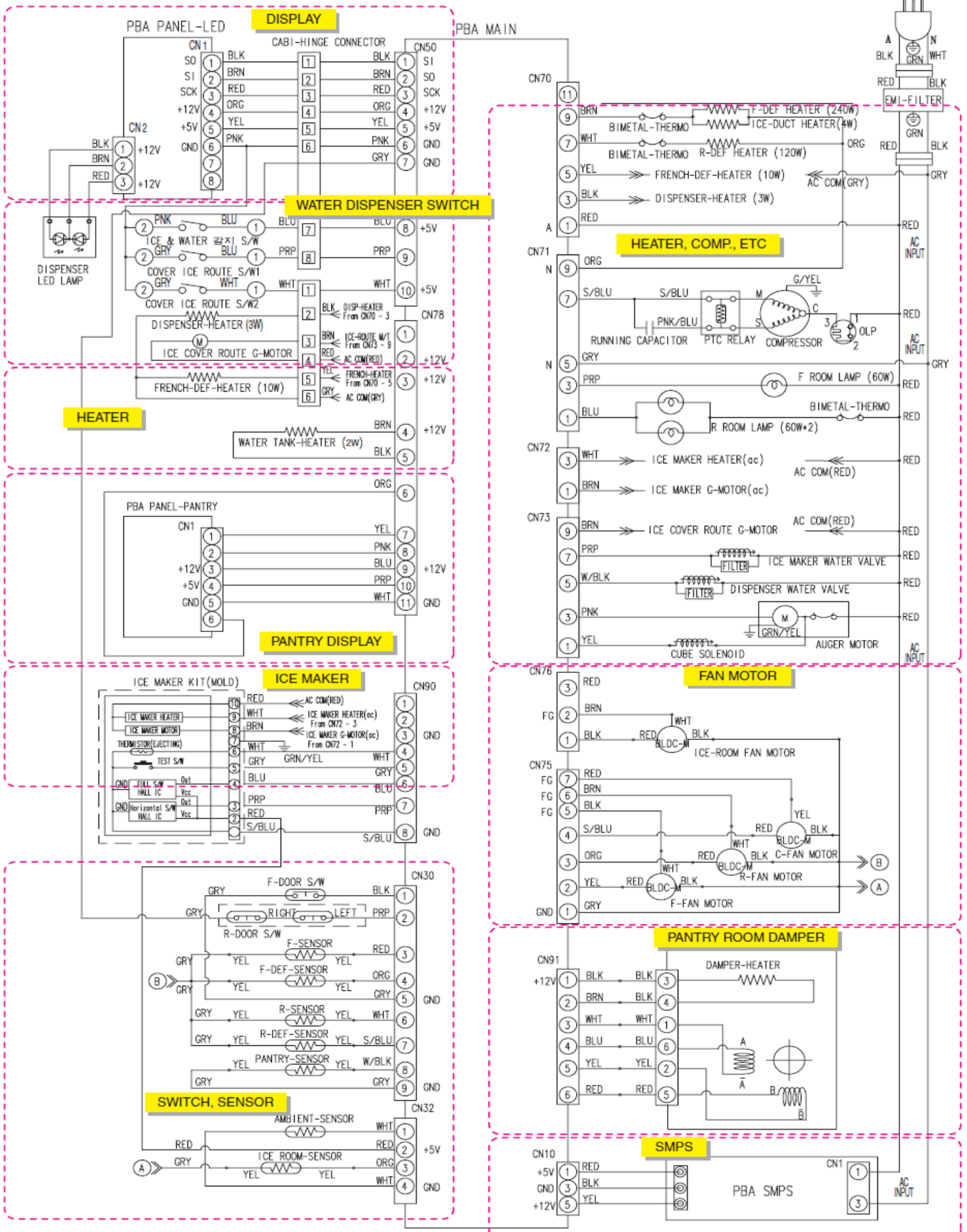

RF267AA**/XAA

Updates

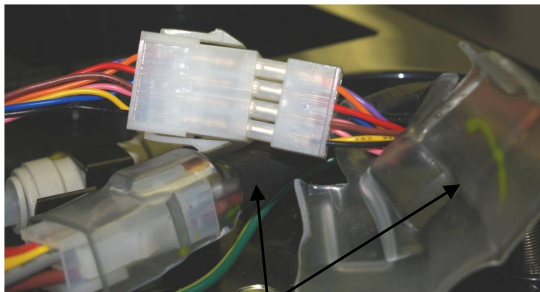
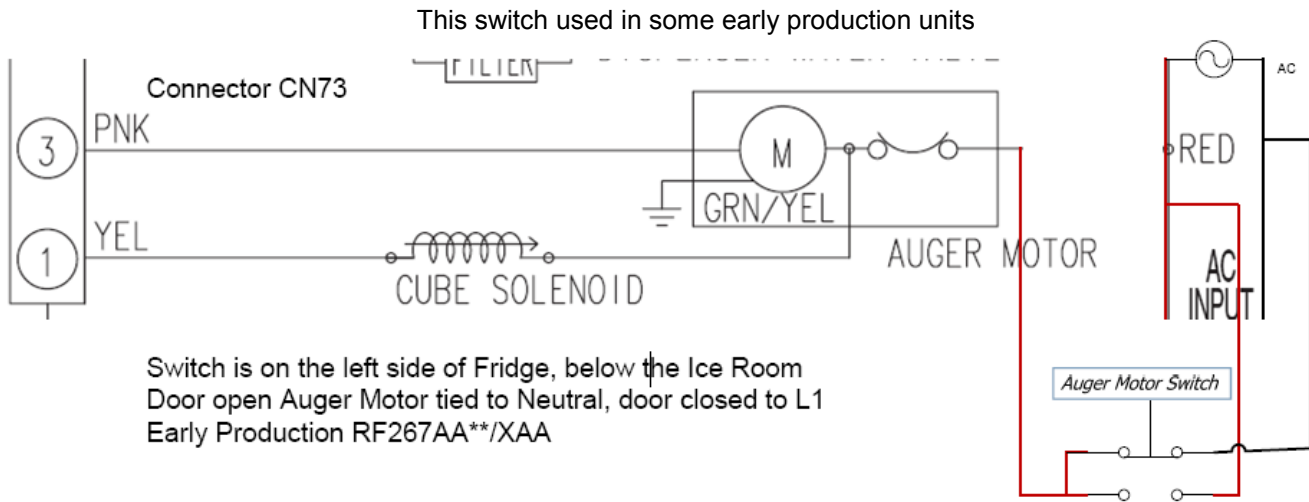

In some cases while removing or reinstalling doors, the hinge connectors can have the wires come loose. Remove all plastic coating and black tape from the Molex connectors, reseal pins. This should correct Display Panel failures.



Water tube coupling with check valve
DA62-00224B

In some cases while removing or reinstalling doors the hoses and/or coupling can be damaged. This will cause a dripping condition at the dispenser. Redress hose ends and/or replace coupling with new part number.

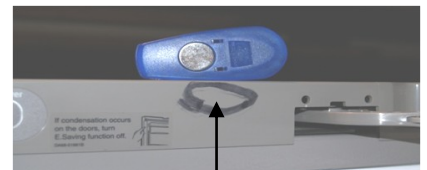

Reed switches are now used for the Fridge, improper installation can cause magnet and reed switch not to line up. Use magnet to test

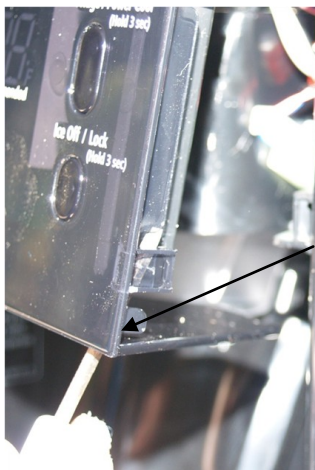
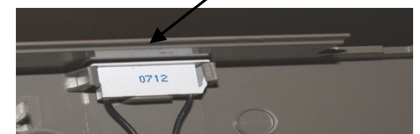

To Remove Panel: Insert Small Screwdriver in Square Hole at Bottom Right Corner. Push Screwdriver to Left To Release Tab

To Remove Freezer Drawer, push plastic tab on each track to release tracks and pull out drawer to remove

