



# Fast Track Troubleshooting

**Models Covered:**  
**RF195AB\*\*/XAA**  
**RF197AB\*\*/XAA**  
**RF217AB\*\*/XAA**  
**French Door**  
**Refrigeration**

**IMPORTANT SAFETY NOTICE – “For Technicians Only”** This service data sheet is intended for use by persons having electrical, electronic, and mechanical experience and knowledge at a level generally considered acceptable in the appliance repair trade. Any attempt to repair a major appliance may result in personal injury and property damage. The manufacturer or seller cannot be responsible, nor assume any liability for injury or damage of any kind arising from the use of this data sheet.

Publication # **tsRF197AB** Revision Date 03/30/2011

**Self Diagnosis: Press the Pwr Freeze—Pwr Cool buttons simultaneously for 8-12 seconds (No sound when both buttons are pressed at the same time) until the display quits blinking. Release the buttons and read Fault Codes. This will also cancel the Fault Mode created by self-diagnosis at power up.**

**Forced Mode: Press the Pwr Freeze– Fridge buttons simultaneously for 8-12 seconds (No sound when both buttons are pressed at the same time) until the display beeps and goes blank.**



**Wait 5 seconds between button pushes**

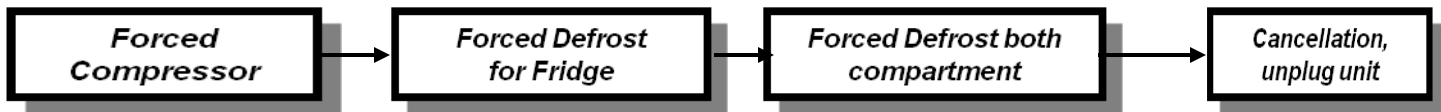

Press the Freezer button one time at the Test Mode to Force Compressor Run. Measure fan and compressor voltage at main PCB.

Press the Freezer button a second time to Force Fridge Defrost. Measure defrost voltage at main PCB.

Press Freezer button a third time to Force Defrost for Fridge & Freezer, measure defrost voltages at main PCB

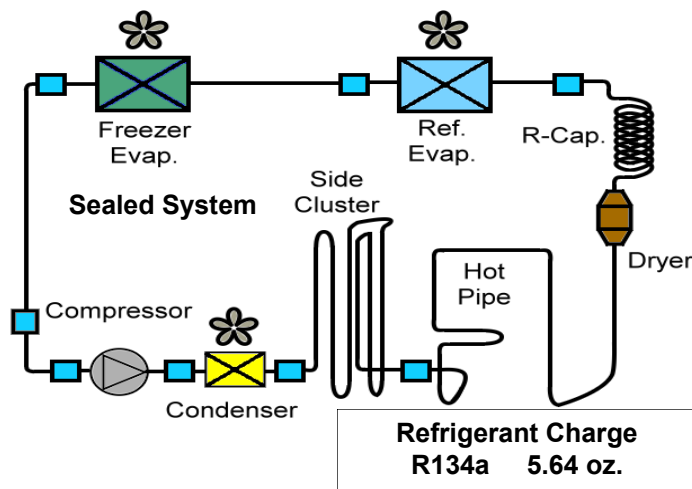

### Sales Mode, No Compressor Operation

Press Power Freeze & Freezer temp buttons simultaneously for 3 sec ( you will hear a “Ding Dong”) to remove or put into Sales Mode. When in the Sales Mode the Display will show "OF" "OF"  
 Removing power will not cancel this mode.

Component Value Chart

| Component              | Resistance | Wattage | Voltage  |
|------------------------|------------|---------|----------|
| Freezer Defrost Heater | 60Ω        | 240     | 120vac   |
| Fridge Defrost Heater  | 120Ω       | 120     | 120vac   |
| Fill Tube Heater       | 1100Ω      | 13      | 120vac   |
| French Mullion Heater  | 2057Ω      | 7       | 120vac   |
| Sensors                | 2.5k-89k   | N/A     | 1~4.5vdc |
| Fans                   | N/A        | N/A     | 7~12vdc  |

### SUPPORT INFORMATION

Training — Plus One <http://my.plus1solutions.net/clientPortals/samsung/>  
 Help — GSPN <http://service.samsungportal.com/>  
 Samsung Product Support TV <http://support-us.samsung.com/spstv/howto.jsp>  
 Customer information videos and chat programs. Programs for Fridges, Laundry, Ranges & D/W

## DC FAN MOTORS

Brushless DC Fan motors are used to save energy. The fans operate at two speeds. Fan speed information is read by the Main PCB. If the fan speed exceeds 600 RPM or the speed is too slow, or stopped the fan drive circuit is disabled, After 10 seconds the circuit tries again with 3 seconds of DC voltage. If the fan continues this activity for 5 cycles, 10 seconds off 3 seconds on, the fan drive circuit is disabled for 10 minutes.

### TO TEST THE FAN CIRCUIT VOLTAGE.

Power off and back on to check the DC voltage to the motor, wait from 10 to 60 seconds for the fan voltage to kick in, and then check fan voltage, the average reading is 9 VDC. If you get 3 seconds of voltage every 10 seconds for the 5 fan power up cycles, then the Main PCB is good.

**NOTE:** You may need to put unit in FORCED FREEZE mode to activate the fans/compressor.

If the fan blade is blocked by ice, then defrost and check the motor again, after removing power from the unit.

If the evaporator is ice blocked and thus blocking the air flow, the fan will over RPM and will be stopped. Remove ice and check the motor again. If everything is clear around the fan blade then the motor would be at fault. Continuous fan errors will be displayed on the front panel display. **PLEASE NOTE:** The door switches control the evaporator fan motors. Have them closed to test the motors. Delay time 10 – 60 seconds.

### FLEX TRAY Ice Makers

When the initial power is applied, the ice tray will stand by for 2 hours. After the 2-hour standby time, the Ice Maker Sensor will check the temperature, when it is lower than 1.5°F for more than 5 minutes, it will do a harvest, with or without ice in the tray, then fill with water. 58 minutes after water is supplied to the Ice Tray, the Ice Maker Sensor temperature will be checked. When the Ice Maker Sensor maintains lower than 1.5°F for 5 minutes, it completes the harvest (if the ice bin is not sensed as full).

#### Filling the tray

After the water fill is completed, the ice maker sensor will evaluate the water volume one and a half minutes later. When it detects no or low water level, it will add more water. First supply time will be 1.5 sec, next one will be 1 sec and the last will be 2 sec.

### Shattered Ice – Flex Tray

When all ice shatters, it's because of a bad tray or ice cube temp that is too cold (lower than -5 degrees). In some areas, there are water issues that can also cause shattered cubes. The temp in the freezer should not have any effect on this issue, as long as it's below 1.5 degrees F, as a properly installed sensor will not read the freezer temp, only the water/ice temp.

Check the Ice tray for defects in the plastic. Ice that is too cold will shatter during harvest. This can be from the (1) sensor not reading the correct temp (2) or the sensor not mounted correctly (3). By programming the ice-maker offset value to a lower number (4), the board not understanding the reading.

**Please note, some shattering is normal for a flex tray icemaker.**

### FREEZER TEMPERATURE CONTROL BY THE ICE MAKER



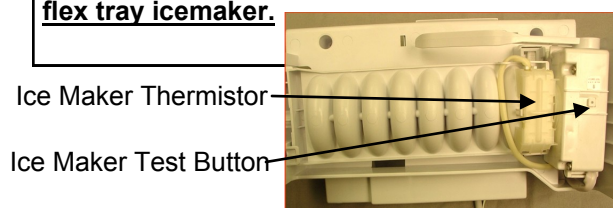















Interior Temperature of the freezer will be set to -14 degrees Fahrenheit until the ice bucket is full. When the ice bucket is full, the freezer will maintain original set temperature. Also, whenever the ice is used, the freezer will again set to -14 degrees Fahrenheit. Selecting "Ice Off" will allow the freezer to be controlled by the set temperature. If water is not hooked up, the freezer will always be at -14 unless "Ice Off" is selected.



**Temperature/Resistance/Voltage Chart for Samsung Refrigerators Sensors**

| Temp.   | (Ω)   | Volts | Temp.  | (Ω)   | Volts | Temp.   | (Ω)   | Volts | Temp.   | (Ω)  | Volts |
|---------|-------|-------|--------|-------|-------|---------|-------|-------|---------|------|-------|
| -29.2°F | 64227 | 4.326 | 1.4°F  | 28021 | 3.685 | 32.0°F  | 13290 | 2.853 | 62.6°F  | 6771 | 2.019 |
| -27.4°F | 61012 | 4.296 | 3.2°F  | 26760 | 3.64  | 33.8°F  | 12749 | 2.802 | 64.4°F  | 6521 | 1.974 |
| -25.6°F | 57977 | 4.264 | 5.0°F  | 25562 | 3.594 | 35.6 °F | 12233 | 2.751 | 66.2°F  | 6281 | 1.929 |
| -23.8°F | 55112 | 4.232 | 6.8°F  | 24425 | 3.548 | 37.4 °F | 11741 | 2.7   | 68.0°F  | 6052 | 1.885 |
| -22.0°F | 52406 | 4.199 | 8.6°F  | 23345 | 3.501 | 39.2 °F | 11271 | 2.649 | 69.8°F  | 5832 | 1.842 |
| -20.2°F | 49848 | 4.165 | 10.4°F | 22320 | 3.453 | 41.0°F  | 10823 | 2.599 | 71.6°F  | 5621 | 1.799 |
| -18.4°F | 47431 | 4.129 | 12.2°F | 21345 | 3.405 | 42.8°F  | 10395 | 2.548 | 75.2°F  | 5225 | 1.716 |
| -16.6°F | 45146 | 4.093 | 14.0°F | 20418 | 3.356 | 44.6°F  | 9986  | 2.498 | 77.0°F  | 5000 | 1.675 |
| -14.8°F | 42984 | 4.056 | 15.8°F | 19537 | 3.307 | 46.4°F  | 9596  | 2.449 | 78.8°F  | 4861 | 1.636 |
| -13.0°F | 40938 | 4.018 | 17.6°F | 18698 | 3.258 | 48.2°F  | 9223  | 2.399 | 80.6°F  | 4690 | 1.596 |
| -11.2°F | 39002 | 3.98  | 19.4°F | 17901 | 3.208 | 50.0°F  | 8867  | 2.35  | 86.0°F  | 4218 | 1.483 |
| -9.4°F  | 37169 | 3.94  | 21.2°F | 17142 | 3.158 | 51.8°F  | 8526  | 2.301 | 87.8°F  | 4072 | 1.447 |
| -7.6°F  | 35433 | 3.899 | 23.0°F | 16419 | 3.107 | 53.6°F  | 8200  | 2.253 | 89.6°F  | 3933 | 1.412 |
| -5.8°F  | 33788 | 3.858 | 24.8°F | 15731 | 3.057 | 55.4°F  | 7888  | 2.205 | 91.4°F  | 3799 | 1.377 |
| -4.0°F  | 32230 | 3.816 | 26.6°F | 15076 | 3.006 | 57.2°F  | 7590  | 2.158 | 95.0°F  | 3547 | 1.309 |
| -2.2°F  | 30752 | 3.773 | 28.4°F | 14452 | 2.955 | 59.0°F  | 7305  | 2.111 | 96.8°F  | 3428 | 1.277 |
| -0.4°F  | 29350 | 3.729 | 30.2°F | 13857 | 2.904 | 60.8°F  | 7032  | 2.064 | 100.4°F | 3204 | 1.213 |

Samsung 'Refrigerator' Diagnostic Code Quick Guide

| Error Items                       | LED   | TROUBLE  | TESTING   |
|-----------------------------------|---|--|---|
| I/M-SENSOR (R on Twin I/M units)  |    | Ice Maker Sensor Error- open or short-circuit, connector failure. Cause is also a temperature reading > 122° or < -58 ° F                      | The voltage at MAIN PCB Sensor between 4.5V~1.0V        |
| R-SENSOR                          |    | Refrigerator Room Sensor Error- open or short-circuit, connector failure. Cause is also a temperature reading > 122° or < -58 ° F.             | The voltage at MAIN PCB Sensor between 4.5V~1.0V        |
| DEFROST SENSOR OF R ROOM          |    | Ref. Defrost Sensor Error- open or short-circuit, connector failure. Cause is also a temperature reading > 122° or < -58 ° F                   | The voltage at MAIN PCB Sensor between 4.5V~1.0V        |
| R-FAN ERROR                       |    | This error indicates the Refrigerator Evap Fan is not spinning at the correct RPM or the fan feedback line is open.                            | Fan voltage at MAIN PCB shall be between 7V~12V         |
| I/M FUNCTION ERROR(R on Twin I/M) |    | This error indicates the Ice tray has not returned to level after an ice harvest. The error is displayed after three failed attempts.          | Replace I/M   |
| R-DEFROSTING ERROR                |    | Refrigerator Room defrost heater- open or short-circuit, connector failure, or defective temperature fuse/bi-metal. Defrost on over 80 minutes | Disconnect defrost connector from PCB, check resistance |
| PANTRY-DAMPER-HEATER ERROR        |    | Sensor system in Pantry Room errors  | Disconnect heater connector from PCB, check resistance  |
| PANTRY-SENSOR ERROR               |   | CR Room Sensor Error- This can be an open or short-circuit, contact failure. Cause is also a temperature reading > 122° or < -58 ° F.          | The voltage of MAIN PCB Sensor between 4.5V~1.0V        |
| WATER HEATER ERROR                |  | Error is displayed when the water reservoir tank heater is open or shorted   | Disconnect heater connector from PCB, check resistance  |
| EXT-SENSOR                        |  | Ambient Temp. Sensor Error- open or short-circuit, connector failure. Cause is also a temperature reading > 122° or < -58 ° F                  | The voltage at MAIN PCB Sensor between 4.5V~1.0V        |
| F-SENSOR                          |  | Freezer Compartment Sensor Error- open or short-circuit, connector failure. Cause is also a temperature reading > 122° or < -58 ° F            | The voltage at MAIN PCB Sensor between 4.5V~1.0V        |
| F-DEF-SENSOR                      |  | Freezer Room Defrost Sensor Error- open or short-circuit, connector failure. Cause is also a temperature reading > 122° or < -58 ° F           | The voltage at MAIN PCB Sensor between 4.5V~1.0V        |
| F-FAN ERROR                       |  | This error indicates the Freezer Evap. Fan is not spinning at the correct RPM or the fan feedback line is open.                                | Fan voltage at MAIN PCB shall be between 7V~12V         |
| C-FAN ERROR                       |  | This error indicates the Condenser Fan is not spinning at the correct RPM or the fan feedback line is open.                                    | Fan voltage at MAIN PCB shall be between 7V~12V         |
| FRENCH DOOR ICE ROOM SENSOR       |  | Ice Room Sensor Error- open or short-circuit, connector failure. Cause is also a temperature reading > 122° or < -58 ° F                       | The voltage at MAIN PCB Sensor between 4.5V~1.0V        |
| F-DEFROSTING ERROR                |  | Freezer defrosting heater- open or short-circuit, connector failure, or defective temperature fuse/bi-metal. Defrost on for over 80 minutes    | Disconnect defrost connector from PCB, check resistance |
| FRENCH DOOR ICE ROOM FAN ERROR    |  | This error indicates the Ice Room Compartment Evap. Fan is not spinning at the correct RPM or the fan feedback line is open.                   | Fan voltage at MAIN PCB shall be between 7V~12V         |
| Uart ERROR COMMUNICATION          |  | This error is not applicable, if the error is detected during diagnostic testing please ignore it.   | No Repair Necessary                                     |
| L↔M ERROR COMMUNICATION           |  | Communication error within the Main PCB  | Replace main PCB  |
| P↔M ERROR COMMUNICATION           |  | Communication between the Main PCB and Keypad  | Check wiring in door & cabinet, Panel PCB, Main PCB     |



CN= Connector # for measuring voltages; () means go to connector #, pin # shown in () for voltage common.

**CN30 Sensors & Switches** Component Name

4-(CN76-1) F Def Sensor (Org-Gry) 2.3~4.2vdc

Voltage on operating component

Pin #s & wire colors on each connector to measure voltages

**Key To Read PCB Layout**

**CN71 120vac**

- 1-(CN72-9) French Htr(7W) (Yel-Red)
- 3-(CN72-9) R Lamps (Blu-Red)
- 5-(CN72-9) F Lamp (Pnk-Red)
- 7 Common N (Gry)
- 9-(CN72-9) I/M Valve(Prp-Red)

**CN72 120vac**

- 1-9 Comp (S/Blu-Red)
- 3-Heater Common (Org)
- 5-3 R Defrost /Fill Tube Htr (Wht-Org)
- 7-3 F Defrost (Brn-Org)
- 9- Common Line L (Red)

**CN30 Sensors & Switches**

- 1-7 Freezer Dr Sw (Blk-Gry)
- 2-8 R Door Sw (Brn-Gry)
- 3-8 R Sensor (Red-Gry) 1~4.5vdc
- 4-8 R Def Sensor (Org-Gry) 1~4.5vdc
- 5-8 F Sensor (Yel-Gry) 1~4.5vdc
- 6-8 F Def Sensor (Pnk-Gry) 1~4.5vdc
- 7-VDC GND (Gry)
- 8-VDC GND (Gry)

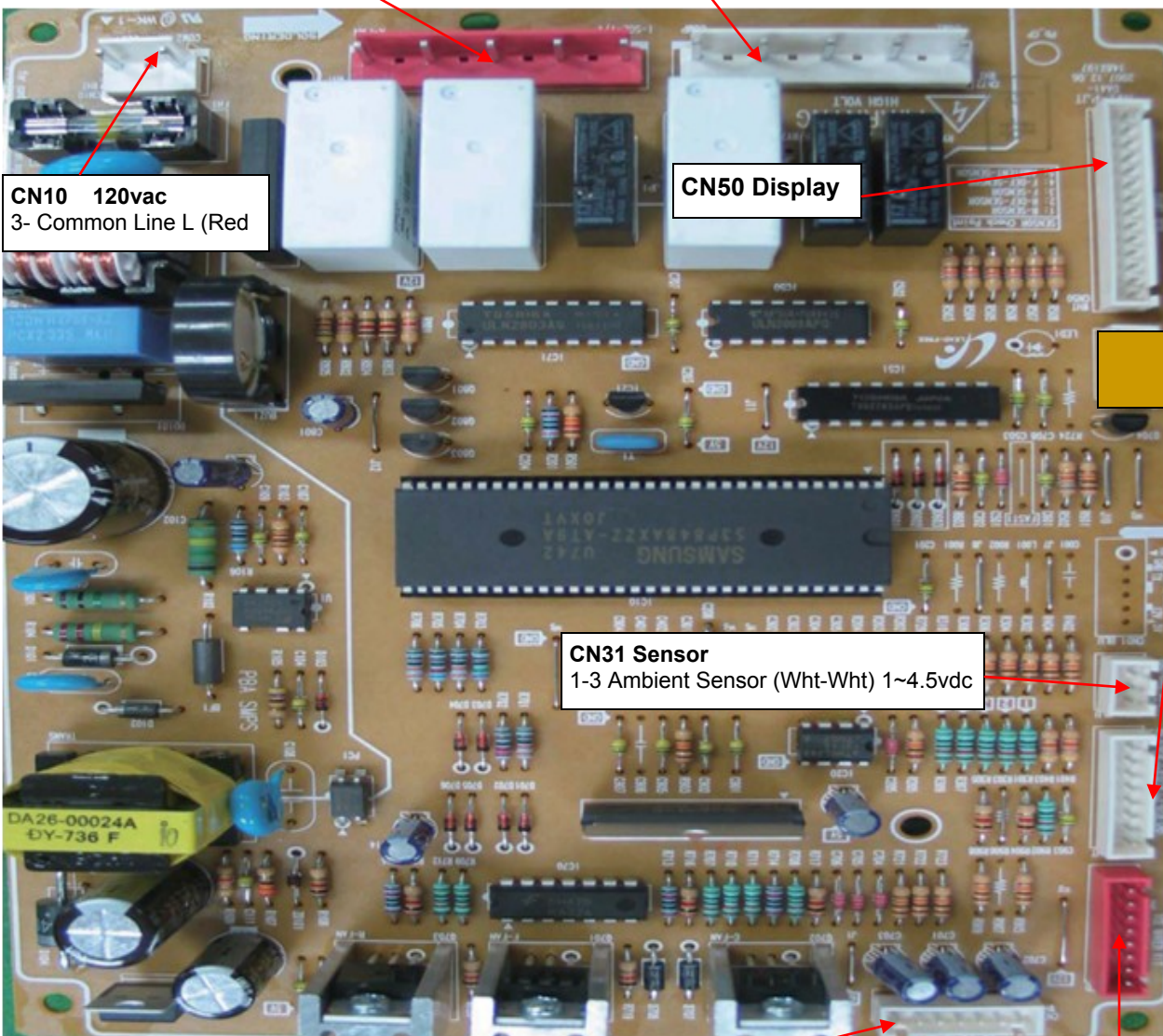

**CN10 120vac**

- 3- Common Line L (Red)

**CN50 Display**

**CN31 Sensor**

- 1-3 Ambient Sensor (Wht-Wht) 1~4.5vdc

**CN76 F, R, C Fans**

- 1- C Fan FG(Blu)
- 2- F Fan FG (Pnk)
- 3- R Fan FG(Yel)
- 4-7 C Fan (Org-Gry) 7~12vdc
- 5-7 F Fan (Red-Gry) 7~12vdc
- 6-7 R Fan (Brn-Gry) 7~12vdc

**CN90 Ice Maker**

- 1-2 I/M Motor (Red-Blk) 12vdc
- 3-4 I/M Sensor (Wht-Wht) 1~4.5vdc
- 5-8 Test Sw (Gry-S/Blu) 5vdc
- 6- 8 (Blu-S/Blu) 5vdc
- 7 Hall IC output (Prp)
- 8-VDC GND

RF195AB\*\*/XAA  
 RF197AB\*\*/XAA  
 RF217AB\*\*/XAA

