



# Fast Track Troubleshooting

## Models:

RB195ZA\*\*/XAA  
RB215ZA\*\*/XAA

**IMPORTANT SAFETY NOTICE – “For Technicians Only”** This service data sheet is intended for use by persons having electrical, electronic, and mechanical experience and knowledge at a level generally considered acceptable in the appliance repair trade. Any attempt to repair a major appliance may result in personal injury and property damage. The manufacturer or seller cannot be responsible, nor assume any liability for injury or damage of any kind arising from the use of this data sheet.

Publication # tsRB195ZA Revision Date 03/30/2011

**Self Diagnosis:** Press the Super Freeze—Super Cool buttons simultaneously for 8-12 seconds (No sound when both buttons are pressed at the same time) until the display quits blinking. Release the buttons and read Fault Codes. This will also cancel the Fault Mode created by self-diagnosis at power up.

**Forced Mode:** Press the Super Cool—Fridge buttons simultaneously for 8-12 seconds (No sound when both buttons are pressed at the same time) until the display beeps and goes blank.



Wait 5 seconds between button pushes

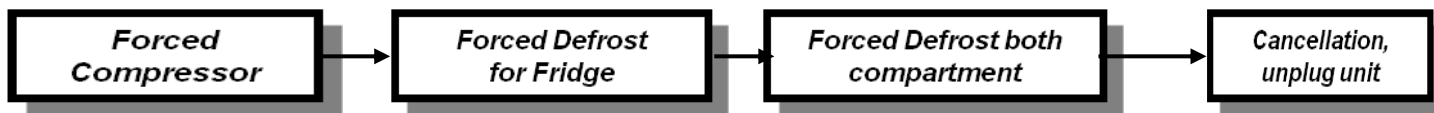

Press the Freezer button one time at the Test Mode to Force Compressor Run. Measure fan and compressor voltage at main PCB.

Press the Freezer button a second time to Force Fridge Defrost. Measure defrost voltage at main PCB.

Press Freezer button a third time to Force Defrost for Fridge & Freezer, measure defrost voltages at main PCB

Refrigerant Charge R134a 5.64 oz.

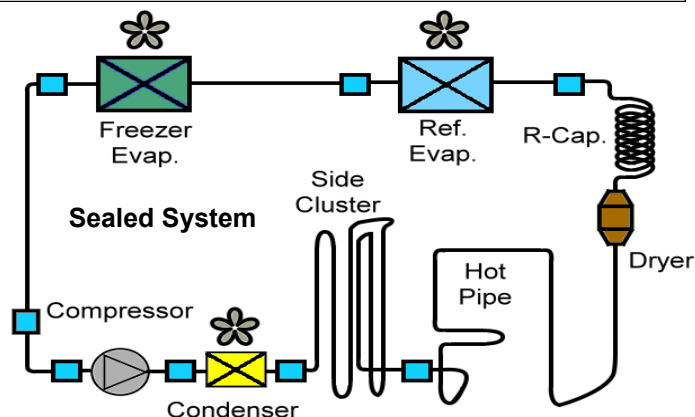

**Sales Mode, No Compressor Operation**

Press Power Freeze & Freezer temp buttons simultaneously for 3 sec ( you will hear a “Ding Dong”) to remove or put into Sales Mode. When in the Sales Mode the Display will show "OF" "OF"

Component Value Chart

Component	Resistance	Wattage	Voltage
Freezer Defrost Heater	60Ω	242	120vac
Fridge Defrost Heater	120Ω	120	120vac
Freezer Drain Heater	277Ω	52	120vac
Fridge Drain Heater	379Ω	38	120vac
Fill Tube Heater	1100Ω	10	120vac
Sensors	2.5k-89k	N/A	1~4.5vdc

## SUPPORT INFORMATION

Training — Plus One <http://my.plus1solutions.net/clientPortals/samsung/>

Help — GSPN <http://service.samsungportal.com/>

Samsung Product Support TV <http://support-us.samsung.com/spstv/howto.jsp>

Customer information videos and chat programs. Programs for Fridges, Laundry, Ranges & D/W

## Sensors

**Defrost** – The sensor voltage tells the Main PCB to turn off the Defrost Heater At 50° in Freezer, 63° in Fridge

**Compartment Temp** – The sensor controls fan/compressor on/off to maintain temp

**Ice Production** – harvests when the I/M sensor reads 1.5 degrees for 5 minutes, Flex Tray Only.

If the door is opened during that 5 minutes harvest is delayed.

## Ambient Sensor

### DEFROST

This model series uses a Defrost Heater in the Fridge and the Freezer compartment that is part of the Evaporator Coil.

NOTE: Evaporator Covers May Break If Removed While Frozen To Coil. They must be replaced if there is any damage, as this will cause “ice” to form at top or bottom of the evaporator coil or in the drains.

## How to Check Sensor Resistances Accurately

Make ice slurry. To do this, fill a cup with ice (preferably crushed), then add water and a teaspoon of salt to make a slush. Mix thoroughly and allow to sit for 2 to 3 minutes. This will give you a 32°F reference. Now, lower the sensor into the mixture and leave for about 1 minute, then check the resistance. It should be very close to 13,300 ohms. Before reinstalling the sensor, be sure to rinse it with fresh water and dry it.

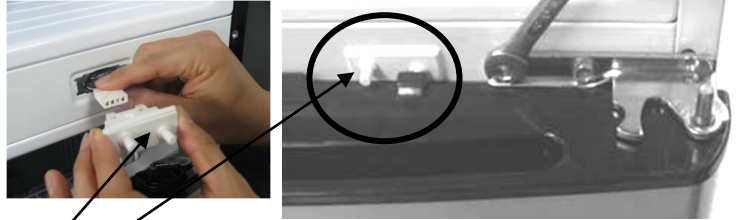

The **Door Switch** must always be on the side the hinge is on. If not, the Fridge door may not always close properly, creating

Defrost Cycle Timing	First Defrost Cycle, Both Fridge & Freezer	Defrost Cycle Fridge only	Defrost Cycle Fridge & Freezer
	4 hrs, Pause Time 10 minutes	6~11 hrs (varies according to conditions)	12~22 hrs (varies according to conditions)

**Fridge and Freezer evap fans** are 120vac, controlled by a 5vdc door switch, a small resistance in the door switch will cause an intermittent no cool condition.

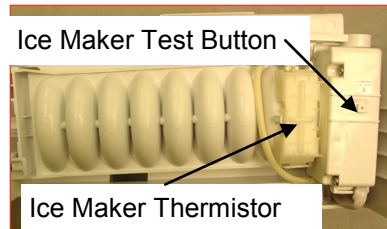
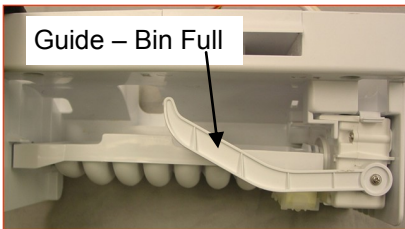

### Shattered Ice – Flex Tray

When all ice shatters, it's because of a bad tray or ice cube temp that is too cold (lower than -5 degrees). In some areas, there are water issues that can also cause shattered cubes. The temp in the freezer should not have any effect on this issue, as long as it's below 1.5 degrees F, as a properly installed sensor will not read the freezer temp, only the water/ice temp.

Check the Ice tray for defects in the plastic. Ice that is too cold will shatter during harvest. This can be from the (1) sensor not reading the correct temp (2) or the sensor not mounted correctly (3). By programming the icemaker offset value to a lower number (4), the board not understanding the reading.

To check the sensor, you must check the tray temp (not air temp) and compare it to the sensor reading. The sensor should read 3.7 volts at the main board connector when the cube temperature is 1 degree. After the fill, the sensor will read water temp 1.5 to 2.2 volts.

















To clear offsets, put unit into Diagnostics mode.

### FLEX TRAY Ice Makers

When the initial power is applied, the ice tray will stand by for 2 hours. After the 2-hour standby time, the Ice Maker Sensor will check the temperature, when it is lower than 1.5°F for more than 5 minutes, it will do a harvest, with or without ice in the tray, then fill with water.

58 minutes after water is supplied to the Ice Tray, the Ice Maker Sensor temperature will be checked. When the Ice Maker Sensor maintains lower than 1.5°F for 5 minutes, it completes the harvest (if the ice bin is not sensed as full).

Thermistor senses temperature to determine water fill on newer units

Samsung 'Refrigerator' Diagnostic Code Quick Guide			
Error Items	LED	TROUBLE	TESTING
I/M-SENSOR (R on Twin I/M units)		Ice Maker Sensor Error- open or short-circuit, connector failure. Cause is also a temperature reading > 122° or < -58 ° F	The voltage at MAIN PCB Sensor between 4.5V~1.0V
R-SENSOR		Refrigerator Room Sensor Error- open or short-circuit, connector failure. Cause is also a temperature reading > 122° or < -58 ° F.	The voltage at MAIN PCB Sensor between 4.5V~1.0V
DEFROST SENSOR OF R ROOM		Ref. Defrost Sensor Error- open or short-circuit, connector failure. Cause is also a temperature reading > 122° or < -58 ° F	The voltage at MAIN PCB Sensor between 4.5V~1.0V
R-FAN ERROR		This error indicates the Refrigerator Evap Fan is not spinning at the correct RPM or the fan feedback line is open.	Fan voltage at MAIN PCB shall be between 7V~12V
I/M FUNCTION ERROR(R on Twin I/M)		This error indicates the Ice tray has not returned to level after an ice harvest. The error is displayed after three failed attempts.	Replace I/M
R-DEFROSTING ERROR		Refrigerator Room defrost heater- open or short-circuit, connector failure, or defective temperature fuse/bi-metal. Defrost on over 80 minutes	Disconnect defrost connector from PCB, check resistance
EXT-SENSOR		Ambient Temp. Sensor Error- open or short-circuit, connector failure. Cause is also a temperature reading > 122° or < -58 ° F	The voltage at MAIN PCB Sensor between 4.5V~1.0V
F-SENSOR		Freezer Compartment Sensor Error- open or short-circuit, connector failure. Cause is also a temperature reading > 122° or < -58 ° F	The voltage at MAIN PCB Sensor between 4.5V~1.0V
F-DEF-SENSOR		Freezer Room Defrost Sensor Error- open or short-circuit, connector failure. Cause is also a temperature reading > 122° or < -58 ° F	The voltage at MAIN PCB Sensor between 4.5V~1.0V
F-FAN ERROR		This error indicates the Freezer Evap. Fan is not spinning at the correct RPM or the fan feedback line is open.	Fan voltage at MAIN PCB shall be between 7V~12V
C-FAN ERROR		This error indicates the Condenser Fan is not spinning at the correct RPM or the fan feedback line is open.	Fan voltage at MAIN PCB shall be between 7V~12V
F-DEFROSTING ERROR		Freezer defrosting heater- open or short-circuit, connector failure, or defective temperature fuse/bi-metal. Defrost on for over 80 minutes	Disconnect defrost connector from PCB, check resistance
ICE PIPE HEATER ERROR		Error is displayed when the ice maker fill pipe heater is open or shorted.	Replace Fill Tube Ass'y
Uart ERROR COMMUNICATION		This error is not applicable, if the error is detected during diagnostic testing please ignore it.	No Repair Necessary
L↔M ERROR COMMUNICATION		Communication error within the Main PCB	Replace main PCB
P↔M ERROR COMMUNICATION		Communication between the Main PCB and Keypad	Check wiring in door & cabinet, Panel PCB, Main PCB

**Temperature/Resistance/Voltage Chart for Samsung Refrigerators Sensors**

Temp.	(Ω)	Volts	Temp.	(Ω)	Volts	Temp.	(Ω)	Volts	Temp.	(Ω)	Volts
-29.2°F	64227	4.326	1.4°F	28021	3.685	32.0°F	13290	2.853	62.6°F	6771	2.019
-27.4°F	61012	4.296	3.2°F	26760	3.64	33.8°F	12749	2.802	64.4°F	6521	1.974
-25.6°F	57977	4.264	5.0°F	25562	3.594	35.6 °F	12233	2.751	66.2°F	6281	1.929
-23.8°F	55112	4.232	6.8°F	24425	3.548	37.4 °F	11741	2.7	68.0°F	6052	1.885
-22.0°F	52406	4.199	8.6°F	23345	3.501	39.2 °F	11271	2.649	69.8°F	5832	1.842
-20.2°F	49848	4.165	10.4°F	22320	3.453	41.0°F	10823	2.599	71.6°F	5621	1.799
-18.4°F	47431	4.129	12.2°F	21345	3.405	42.8°F	10395	2.548	75.2°F	5225	1.716
-16.6°F	45146	4.093	14.0°F	20418	3.356	44.6°F	9986	2.498	77.0°F	5000	1.675
-14.8°F	42984	4.056	15.8°F	19537	3.307	46.4°F	9596	2.449	78.8°F	4861	1.636
-13.0°F	40938	4.018	17.6°F	18698	3.258	48.2°F	9223	2.399	80.6°F	4690	1.596
-11.2°F	39002	3.98	19.4°F	17901	3.208	50.0°F	8867	2.35	86.0°F	4218	1.483
-9.4°F	37169	3.94	21.2°F	17142	3.158	51.8°F	8526	2.301	87.8°F	4072	1.447
-7.6°F	35433	3.899	23.0°F	16419	3.107	53.6°F	8200	2.253	89.6°F	3933	1.412
-5.8°F	33788	3.858	24.8°F	15731	3.057	55.4°F	7888	2.205	91.4°F	3799	1.377
-4.0°F	32230	3.816	26.6°F	15076	3.006	57.2°F	7590	2.158	95.0°F	3547	1.309
-2.2°F	30752	3.773	28.4°F	14452	2.955	59.0°F	7305	2.111	96.8°F	3428	1.277
-0.4°F	29350	3.729	30.2°F	13857	2.904	60.8°F	7032	2.064	100.4°F	3204	1.213

**CN= Connector # for measuring voltages; () means go to connector #, pin # shown in () for voltage common.**  
**CN30 Sensors & Switches** Component Name  
**4-(CN76-1) F Def Sensor (Org-Gry) 2.3~4.2vdc** ← Voltage on operating component  
 Pin #s & wire colors on each connector to measure voltages

**Key To Read PCB Layout**

**Main PCB Layout**  
**RB195BS\*\*/XAA, RB195ZA\*\*/XAA, RB215BS\*\*/XAA,**  
**RB215LA\*\*/XAA, 215ZA\*\*/XAA**

**CN31**  
 1- 4 Ambient Sensor (Wht-Wht) 1.2 ~ 2 vdc

**CN10 120vac**  
 A/C Transformer In (Blu-Blu)

**CN30**  
 1-2 F Door SW (Blk-Brn)  
 3-2 F Room Sensor (Yel-Brn) 3.5 ~ 4.2 vdc  
 4-2 F Def Sensor (Org-Brn) 2.3 ~ 4.2 vdc  
 5-2 R Door Sw (Wht-Brn)  
 7-6 R Room Sensor (Blu-Brn) 2.4 ~ 2.8 vdc  
 8-6 R Def Sensor (Prp-Brn) 2 ~ 4.2 vdc

**CN90 Ice Maker**  
 1-2 I/M Motor (Red-Blk) 12vdc  
 3-4 I/M Sensor (Wht-Wht) 2.1 ~3.7 vdc  
 5-8 Test Sw (Gry-S/Blu)  
 6-8 Horizontal Sw (Blu-S/Blu)  
 7-8 Fill Sw (Prp-S/Blu)

- BLU-BLUE
- BRN-BROWN
- RED-RED
- GRY-GRAY
- ORG-ORANGE
- PNK-PINK
- E-EARTH
- PRP-PURPLE
- S/BLUE-SKY BLUE
- WHT-WHITE
- YEL-YELLOW
- BLK-BLACK
- W/BLK-WHITE/BLACK
- W/RED-WHITE/RED
- W/BLU-WHITE/BLUE
- W/YEL-WHITE/YELLOW

**CN50**  
 Display Panel

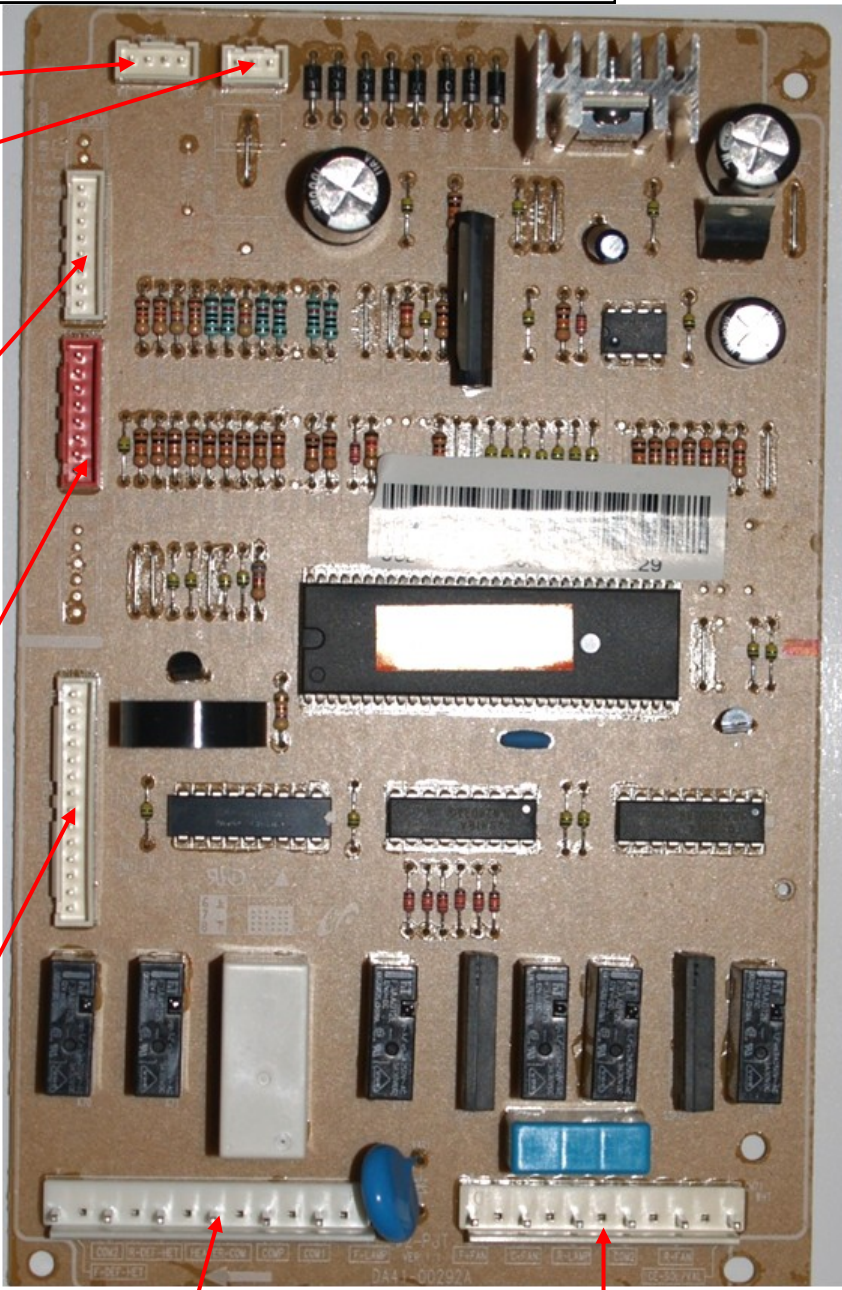

**CN70 120vac**  
 1-11 F Lamp (Pnk-Blk)  
 5-11 Compressor (S/Blu-Blk)  
 9-7 R Heater (R Drain I/M Pipe) (Wht-Org)  
 13-7 F Heater (F Drain) (Brn-Org)

**CN71 120vac**  
 1-5 Ice Water Valve (Prp-Blk)  
 3-5 R-Fan (W/Blu-Blk)  
 7-5 R Lamp (W/Blk-Blk)  
 9-5 C Fan (Blu-Blk)  
 11-5 R Fan (Yel-Blk)

MAIN PCB

