



Service Manual
Tumble Dryer - TD70.C

Service Manual

Contents

Tumble Dryer TD70.C

Updates.....	3
Introduction.....	4
Troubleshooting strategy.....	5
Product overview.....	7
Technical data.....	8
Component descriptions.....	9
Components and measurement values.....	9
Components and function description.....	10
Control unit.....	14
Circuit diagram TD70.C.....	14
Circuit diagram TD70.C Marin.....	16
Circuit diagram TD70.C UL.....	18
Circuit diagram TD70.C HWC.....	20
Circuit diagram TD70.C HP.....	22
Troubleshooting.....	24
Fault indicators.....	24
Service menu.....	25
Service menu.....	25
Service and installation	
Replacing the panel and the control unit.....	29
Transporting a tumble dryer with a heat pump.....	31

Updates

Rev	Date	Description	Initials
01	2011-09-06	First version	FH

Introduction

You are holding the Service manual for the TD70 tumble dryer. The TD70 tumble dryers is available in several models, designated TD70.1, TD70.2, TD70.3. The TD70.C model, that this guide is focusing on, is designed for professional use.

It should be easy to service a tumble dryer. It is important that you, as a service technician, are provided the necessary conditions to work in an efficient and satisfactory manner. Our hope is that this Service manual is a useful tool for your daily work.

Asko Appliances AB
SE-534 82 Vara
Sweden

The type designation can be found on the machine plate, which is located on the inside of the front panel by the door catch (see image below).

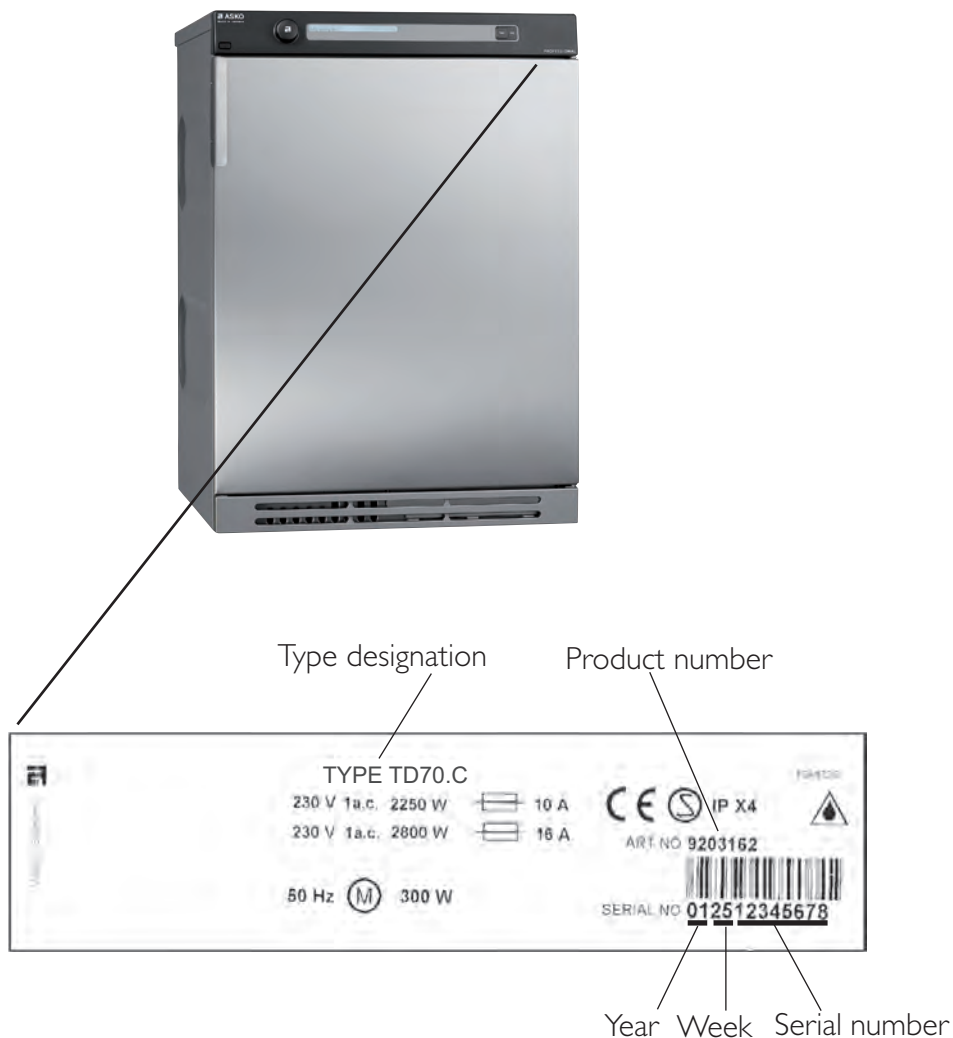

OPERATING INSTRUCTIONS

Always have the operating instructions for the machine available during service

Troubleshooting strategy

Troubleshooting is an important part of the service callout, and as such we have drawn up a troubleshooting strategy that describes, in broad terms and step by step, what you need to do to find and diagnose faults arising in our machines.

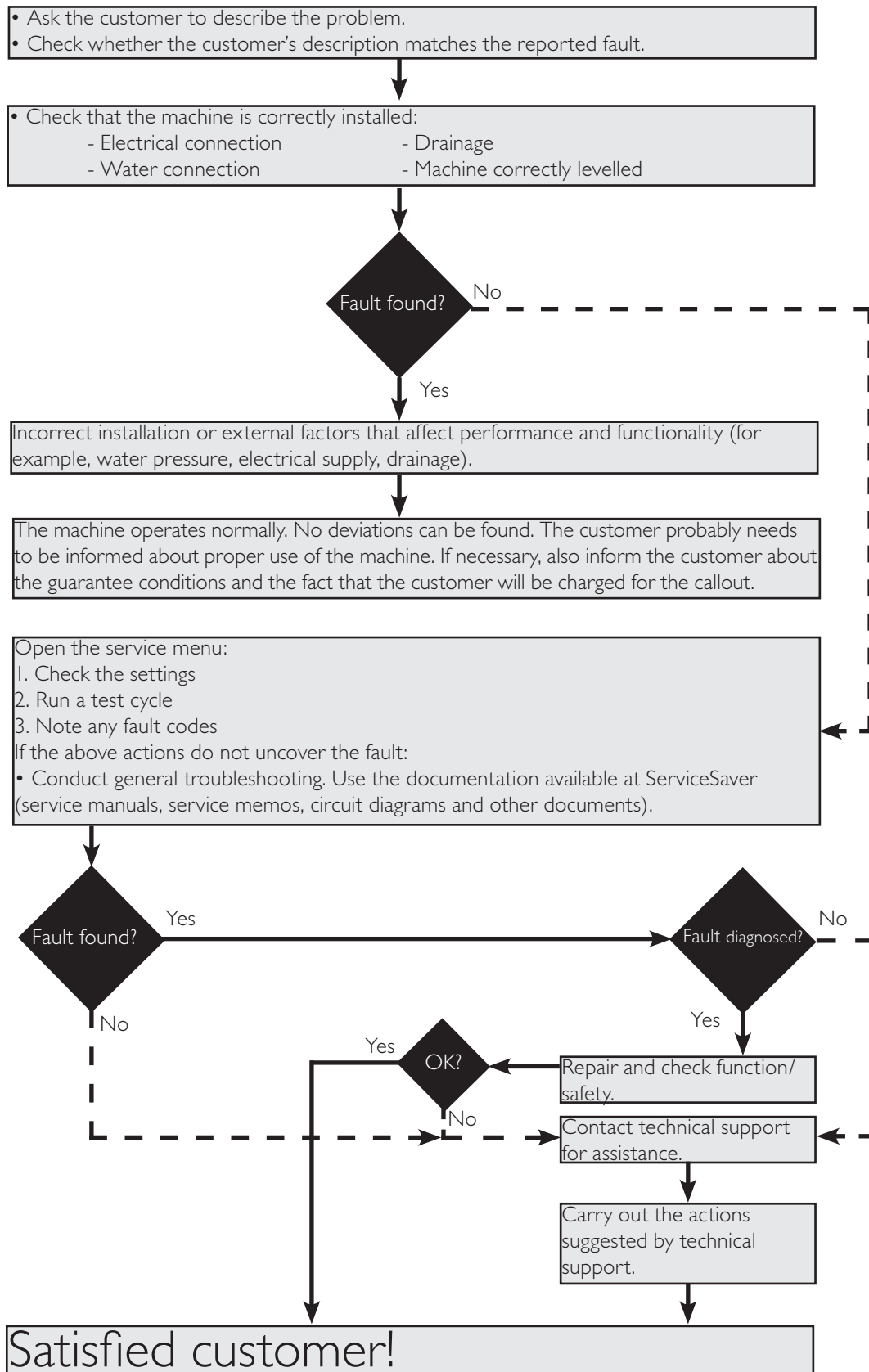

Product overview

TD70.C

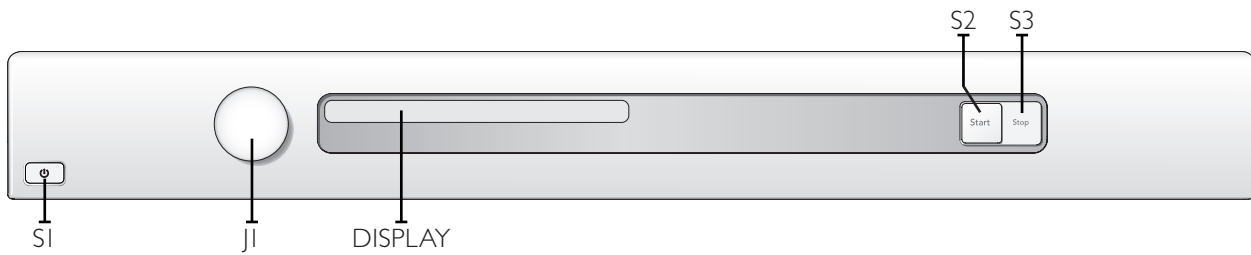

Programmes: A total of 7 programmes.

Settings: 4 settings (Language, Child-safe, Buzzer, Heater 2)

Knob and button descriptions

Turn/Push	Description
	Programme selector (J1) Turn clockwise or anti-clockwise to cycle through the different programmes and options in the various menus.
	Start button (S2) • Starta programme
	Stop button (S3) • Stop programme (press and hold for 3 seconds).

Display description

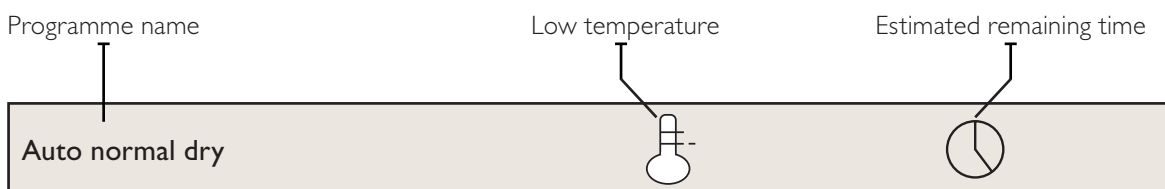

Technical data

Technical information	
Height	850 mm
Width	595 mm
Depth	585 mm
Weight	43 kg (Vented) 47 kg (Condenser) 55 kg (Heat pump) 44 kg (Heating Water Circuit)
Cylinder volume	112 litres
Capacity	EU 7.0 kg US/AU 7.0 kg
Speed	50-55 rpm
Connection	1-phase 230 V, 50/60 Hz, (10 A/16 A) ** 3-phase 400 V, 50/60 Hz, (10 A) **
Rated power	1950 W = 10 A** (Vented/Condenser) 3000 W = 16 A** (Vented) 2500 W = 16 A** (Condenser) 1300 W = 10 A** (Heat pump) 1950 W = 10 A** (Heating Water Circuit) The control buttons are used to switch between 10 A and 16 A via the software. Does not apply to Heat Pump or Heating Water Circuit.
Drum material	Stainless steel
Outer panels	Powder-coated and hot-galvanised sheet steel or stainless steel
Installation	Stacked or freestanding
Protection class	IP X4

** See type plate.

Energy consumption and programme times

See the operating instructions for information on energy consumption and programme times.

Component description

Components and measurement values

The specified resistance values apply at room temperature (about 20°C/68°F). Values within ±10% are considered normal.

Article no.	Component	Measurement value	Comment
80 839 15	Motor 50 Hz, 220/240 V	Winding resistance: cable colour red-white 26.5 Ω cable colour red-blue 53.5 Ω cable colour white-blue 27.0 Ω Current: 0.7 A; 140 W; 2850 rpm	
80 839 16	Motor 60 Hz, 220/240 V	Winding resistance: cable colour red-white 26.5 Ω cable colour red-blue 53.5 Ω cable colour white-blue 27.0 Ω Current: 0.7 A; 140 W; 3300 rpm	The motor is a 2-pin motor and is directly connected to the fan for internal air and the gearing for driving the cylinder. On condenser dryers, the motor also drives the fan for external air.
80 903 13	Capacitor	8 μF	50 Hz
80 903 14	Capacitor	6 μF	60 Hz
80 902 70	Capacitor heat pump	17 μF	50 Hz
80 902 71	Capacitor heat pump		60 Hz
80 821 28	Condensate pump		50 Hz
80 846 48	Condensate pump		60 Hz
80 762 02	EMC-filter with inductor		The filter eliminates interference to and from the machine.
80 833 44	Thermistor	4.8 kΩ (at 25°C)	The thermistor controls temperature regulation. If the thermistor is short-circuited or detaches from the control unit, the programme is stopped.
80 773 85	Thermostat 150	150°C automatic	The thermostat/overheating cut-out stops the programme if the temperature becomes too high.
80 792 00	Thermostat 135	135°C automatic	
80 902 24	Thermostat 110	110°C automatic	
80 761 04	Door switch		The front door triggers a door switch which stops the programme when the door is open. If the door has been opened and closed during the programme the machine must be restarted using the Start/Stop button.
80 761 03	Microswitch float Overflow guard		If both containers in the tumble dryer are full the programme is stopped by a float switch installed in the lower container. "Over flow" is indicated on the display.
	Electrical connection	Condenser I950W/I0A-2500W/I6A Vented I950W/I0A-3000W/I6A Heat pump I300W/I0A Heating Water Circuit I950W/I0A	The machine is delivered as single phase and can be switched between 10 A and 16 A. The control buttons are used to make the switch via the software. Does not apply to Heat Pump or Heating Water Circuit.
80 824 92	Heating element 1950 W	Heater 1: 1950 W, 24.5 Ω	
80 915 90	Heating element 2500 W	Heater 1: 1950 W, 24.5 Ω Heater 2: 550 W, 91.4 Ω	
80 824 91	Heating element 3000 W	Heater 1: 1950 W, 24.5 Ω Heater 2: 1050 W, 45.5 Ω	
80 824 60	Heating element 3000 W	Heater 1: 1950 W, 90.2 Ω Heater 2: 1050 W, 167.6 Ω	Marine 440 V
80 824 61	Heating element 3000 W	Heater 1: 1950 W, 24.5 Ω Heater 2: 1050 W, 45.5 Ω	3-Phase
80 916 18	Heating element 2500 W	Heater 1: 1950 W, 24.5 Ω Heater 2: 550 W, 91.4 Ω	3-Phase
80 821 30	Cooling fan compressor heat pump	637 Ω	
80 821 22	Base heat pump complete		50 Hz
80 821 23	Base heat pump complete		60 Hz
80 88 415	Reversing valve	1.9 kΩ	
80 841 00	Steam generator	68 Ω Thermistor 61.4 kΩ Steam pump 2.15 MΩ	Supplied with steam pump
80 902 22	Reed switch steam tank		
80 889 37	Control unit compl. TD70.C		The control unit contains microprocessors for controlling programmes, the motor, the heating elements etc.
80 846 49	LED-light compl.		LED-technology for the machine's internal light.

Component description

Components and function description

Here we describe the function and specification of the most important components. Certain components are found only in more highly specified machines or in particular markets. See the *Troubleshooting* chapter for fault and information codes.

CU (Control Unit)

The CU (Control Unit) functions as both a control panel and a logic component. The control panel is equipped with knobs/buttons for selecting programmes, Start/Stop buttons and a display. It is an integrated part of the CU and cannot be replaced separately. The logic component manages functions needed for drying programmes and diagnosis. The CU has an internal power supply for the logic component. In the event of a fault, the CU can diagnose a number of components and functions, and a total of 4 fault codes can be displayed. To facilitate troubleshooting there is a component testing function in which the outputs are activated according to a special sequence.

Power supply

Mains voltage, built-in internal voltage converter for the logic component.

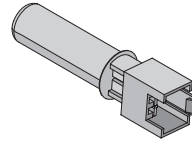

Thermistors

The thermistors are of the NTC type (Negative Temperature Coefficient), which means their resistance decreases as temperature increases.

Thermistor 1 is in the air duct on the front frame, after the internal impeller. If there is an interruption in the thermistor circuit or if it short circuits, the drying programme stops and the display shows "Thermistor fault".

Purpose: Measures the temperature of the air that has passed the load and controls the drying process and the heating element.

Thermistor 2 is only used for condenser dryers and is located after the condenser.

Purpose: Measures the temperature of the dehumidified air, the value of which is used as a parameter in the drying process.

Resistance values for thermistors 1 and 2

Temperature	Resistance
20°C	5989
25°C	4869
30°C	3946
35°C	3197
40°C	2598
45°C	2126
50°C	1758
55°C	1471
60°C	1240
65°C	1043
70°C	857
Tolerance: ±1%	

Personal notes

Component description

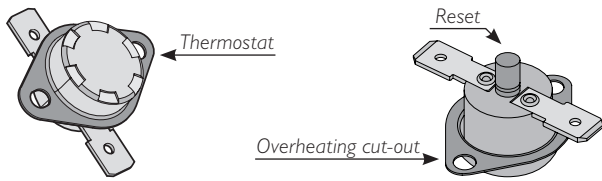

Thermostat and overheating cut-out

The thermostat is installed next to the heating element and is used to reduce the element output by turning it off if the ambient temperature exceeds 135°C ($\pm 5^{\circ}\text{C}$) for condenser dryers and 110°C ($\pm 5^{\circ}\text{C}$) for others.

The machine is equipped with a overheating cut-out, which is available in two versions, one automatically resettable and one manual. The overheating cut-out switches off the power supply to all components if the temperature exceeds 150°C ($\pm 5^{\circ}\text{C}$) and closes the circuit once the temperature drops below 135°C ($\pm 8^{\circ}\text{C}$). The drying programme stops and must be restarted if the overheating cut-out is triggered.

To reset the manual overheating cut-out, the cover plate on the machines back must be removed. Press the button on the overheating cut-out for manual reset.

The automatic overheating cut-out resets when the temperature drops below 135°C ($\pm 8^{\circ}\text{C}$) for condenser dryer and 120°C ($\pm 5^{\circ}\text{C}$) for others.

Purpose: The thermostat measures temperature and controls heating element output. The overheating cut-out controls the temperature and cuts the power supply if the machine overheats.

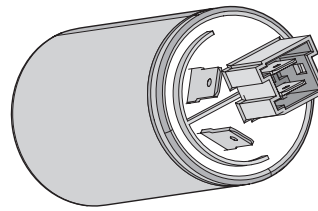
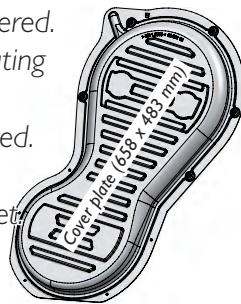

EMC filter

The filter is installed next to the cable fasteners where the connection cable enters the machine. The filter consists of a number of coils, condensers and resistors.

Purpose: To eliminate electromagnetic interference to and from the machine.

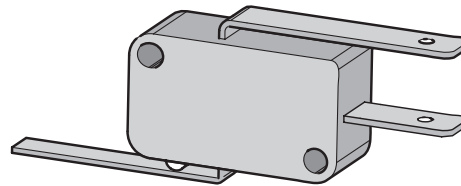

Overflow guard

The overflow guard comprises a microswitch triggered by a float. When the lower condensed water container becomes full the float rises and triggers the microswitch. The microswitch is normally closed; when activated it opens the circuit. When the microswitch has been open for more than 30 seconds, the drying programme stops and the display shows "Over flow". You can erase this message by turning the programme selector or pressing the Start/Stop buttons.

Purpose: To provide protection from any water leaks or flooding from the machine.

Personal notes

Component description

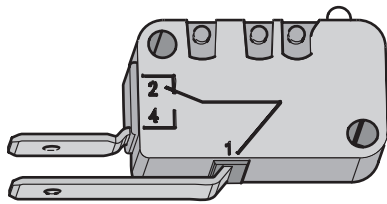

Door switch

The door switch is located in a holder in the middle of the front support and is activated by a pin in the front door. The switch is normally open and closes when the door is closed. If the front door is opened during operation the CU stops the drying programme. The programme starts from the beginning if restarted.

Purpose: To prevent the machine from running while the door is open.

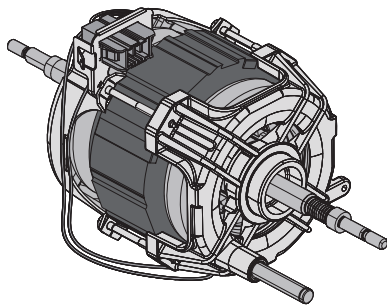

Drying motor

The motor is at the bottom and drives the impeller that is directly fitted to the shaft journal. The motor is a unit with a belt tensioner and springs and drives the drying drum via a poly V-belt.

Purpose: To drive the impeller and drum during the drying process.

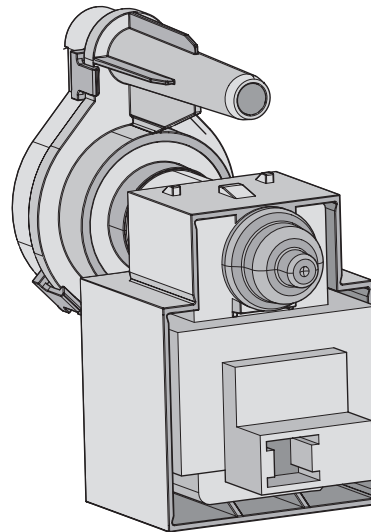

Drainage pump (condenser dryer)

The drainage pump is located in the lower condensed water container. The condensed water is pumped to the condensed water container or directly to the drain. When a drying programme is running, the drainage pump is activated constantly in cycles of 30 seconds ON and 210 seconds OFF.

Purpose: To pump condensed water to the condensed water container or the drain.

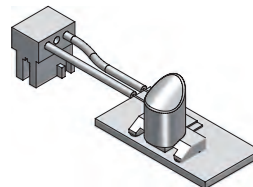

Light

Certain machines have an internal light that is activated when the door is opened. LED technology is used to improve energy efficiency.

Personal notes

Component description

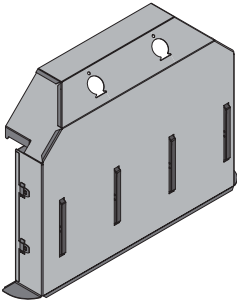

Heating element

The heating element is located in the rear section and consists of two separate heating coils. Each heating coil is made from resistance wire.

Purpose: To heat the drying air to the right temperature.



Auto filter

Tumble dryers with heat pump can be fitted with auto filter, which consists of a water filter and an evaporator filter. The water filter (1) is located under the condensed water container and the evaporator filter (2) is placed in front of the evaporator.

Personal notes

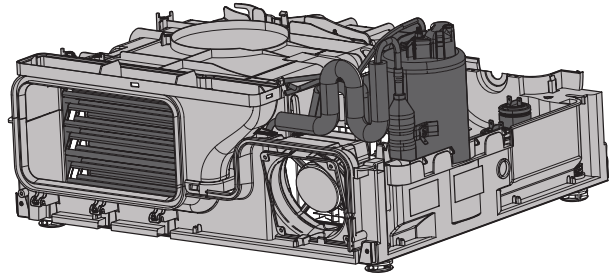

Heat pump

Certain types of machine are fitted with heat pump systems. These systems are closed circuits that are replaced by replacing the machine's base plate with a new module.

The function settings are adjusted in the service menu.

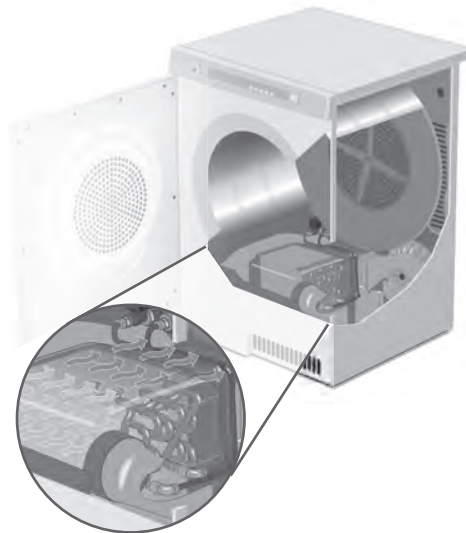

Heating Water Circuit (HWC)

A certain type of machine is adapted for connection to the building's existing heated water supply (such as district heating) to reduce energy consumption.

The function settings are adjusted in the service menu.

Control unit

Circuit diagram TD70.C

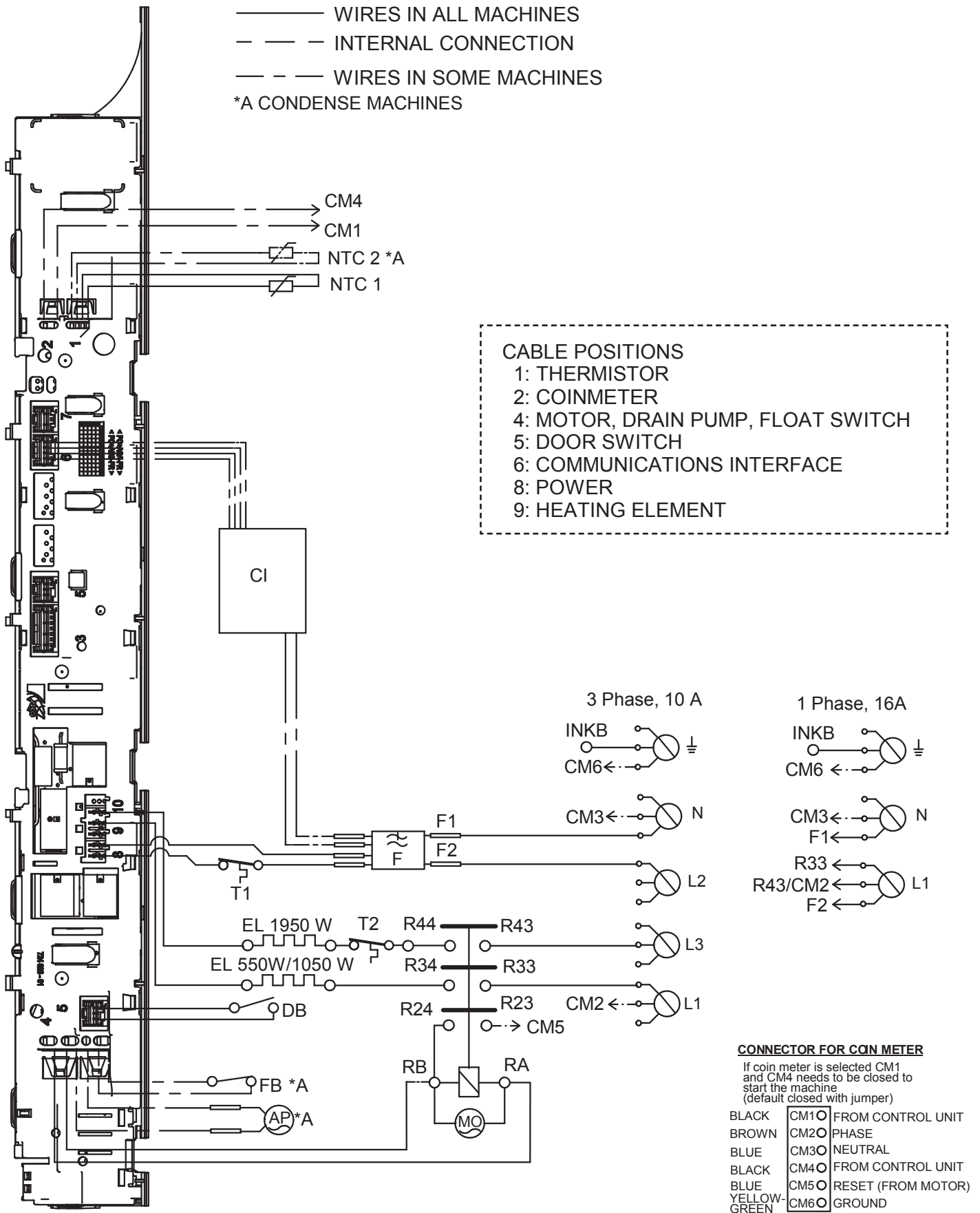

RESISTANCES AT ROOM TEMPERATURE (CA. 20°C/68°F)
 VALUES WITH +/-10% ARE REGARDED AS NORMAL
 COMPONENT

F: RADIO INTERFERENCE SUPPRESSION FILTER	680K Ohm
NTC 1: THERMISTOR 1	4 - 6 K Ohm
NTC 2: THERMISTOR 2:	4 - 6 K Ohm
AP: DRAIN PUMP:	111 Ohm
EL: HEATING ELEMENT 1050W	45.3 Ohm
EL: HEATING ELEMENT 1950W	20.5 Ohm
MO: MOTOR	
T1: THERMOSTAT, OVERHEATING (HEATER)	
T2: THERMOSTAT, OVERHEATING (HEATER)	
FB: FLOAT SWITCH	
DB: DOOR SWITCH	
CI: COMMUNICATIONS INTERFACE	

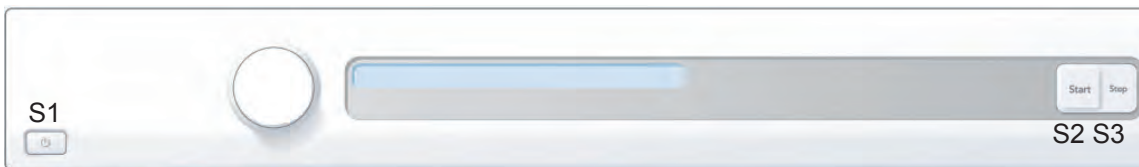

SERVICE MENU

TURN OFF POWER (S1)
 WAIT FOR AT LEAST 5 SEC
 HOLD S2
 TURN ON POWER (S1)
 PRESS S2 5 TIMES TO ENTER SERVICE MENU

PRESS STOP (S3) TO CHANGE MENU STEP
 ROTATE DIAL TO CHANGE IN STEP
 PRESSING START (S2) STORES AND EXITS SERVICE MENU

USER SETTINGS MENU

TURN OFF POWER (S1)
 WAIT FOR AT LEAST 5 SEC
 HOLD S3
 TURN ON POWER (S1)
 PRESS S3 5 TIMES TO ENTER MENU

2011-07-07

CIRCUIT DIAGRAM TD70.C

80 902 58 - 00

This document must not be copied without our written permission, and the contents thereof must not be imparted to a third party nor be used for any unauthorized purpose. Contravention will be prosecuted.
 Asko Appliances AB

Control unit

Circuit diagram TD70.C Marine

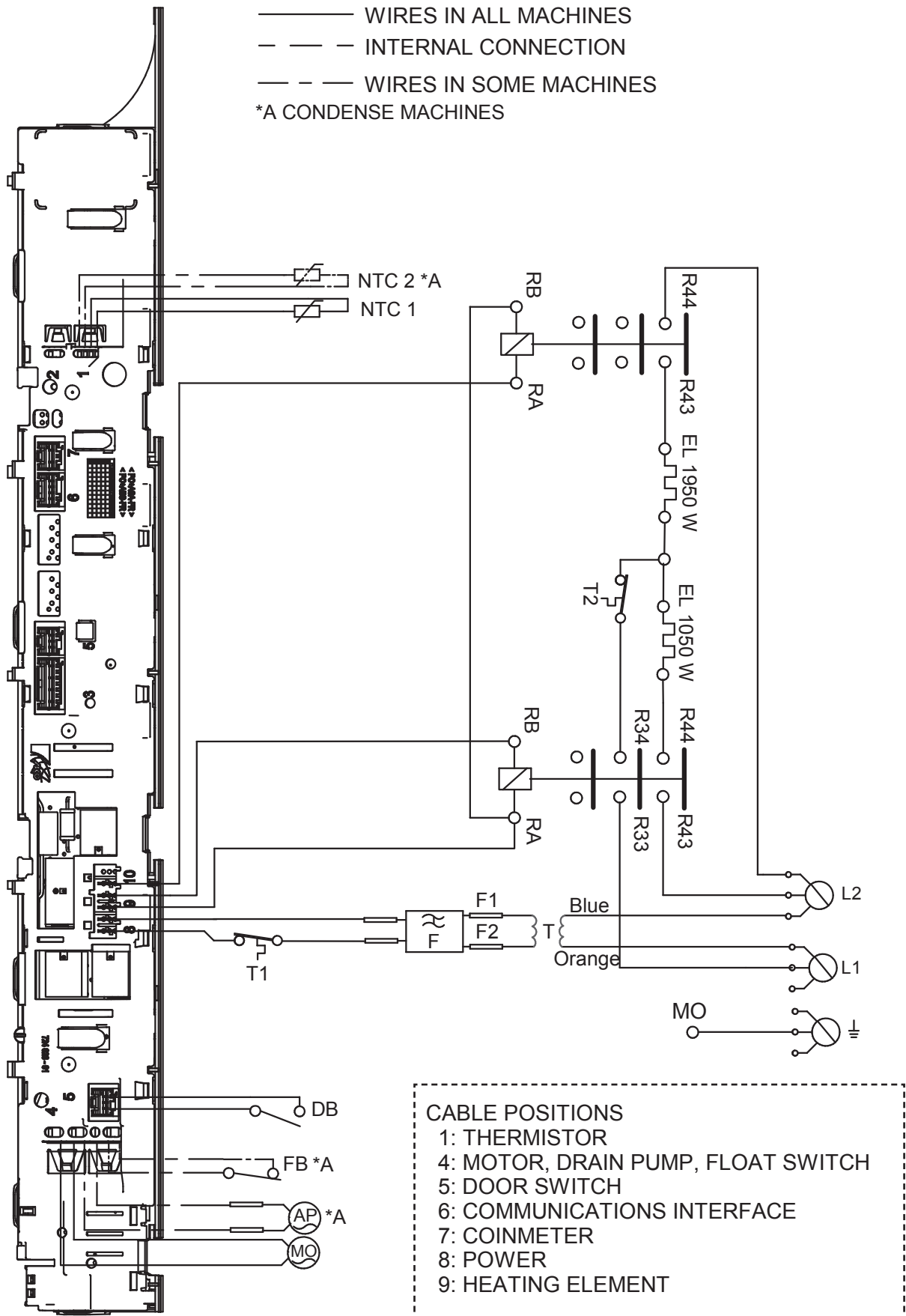

RESISTANCES AT ROOM TEMPERATURE (CA. 20°C/68°F)
 VALUES WITH +/-10% ARE REGARDED AS NORMAL
 COMPONENT

F: RADIO INTERFERENCE SUPPRESSION FILTER	680K Ohm
NTC 1: THERMISTOR 1	4 - 6 K Ohm
NTC 2: THERMISTOR 2:	4 - 6 K Ohm
AP: DRAIN PUMP:	111 Ohm
EL: HEATING ELEMENT 1050W	167,6 Ohm
EL: HEATING ELEMENT 1950W	90,2 Ohm
MO: MOTOR	
T1: THERMOSTAT, OVERHEATING (HEATER)	
T2: THERMOSTAT, OVERHEATING (HEATER)	
FB: FLOAT SWITCH	
DB: DOOR SWITCH	
T: TRANSFORMER 440V/230V	

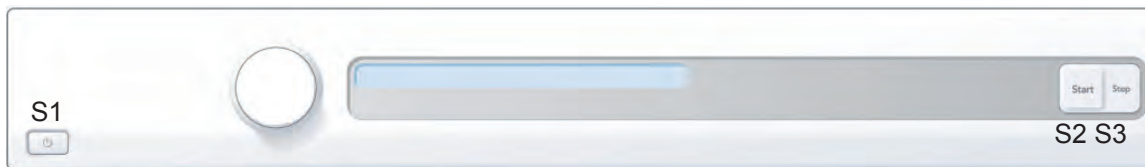

SERVICE MENU

TURN OFF POWER (S1)
 WAIT FOR AT LEAST 5 SEC
 HOLD S2
 TURN ON POWER (S1)
 PRESS S2 5 TIMES TO ENTER SERVICE MENU

PRESS STOP (S3) TO CHANGE MENU STEP
 ROTATE DIAL TO CHANGE IN STEP
 PRESSING START (S2) STORES AND EXITS SERVICE MENU

USER SETTINGS MENU

TURN OFF POWER (S1)
 WAIT FOR AT LEAST 5 SEC
 HOLD S3
 TURN ON POWER (S1)
 PRESS S3 5 TIMES TO ENTER MENU

2011-07-07

CIRCUIT DIAGRAM TD70.C 440 V

80 902 59 - 00

This document must not be copied without our written permission, and the contents thereof must not be imparted to a third party nor be used for any unauthorized purpose. Contravention will be prosecuted.
 Asko Appliances AB

Control unit

Circuit diagram TD70.C UL

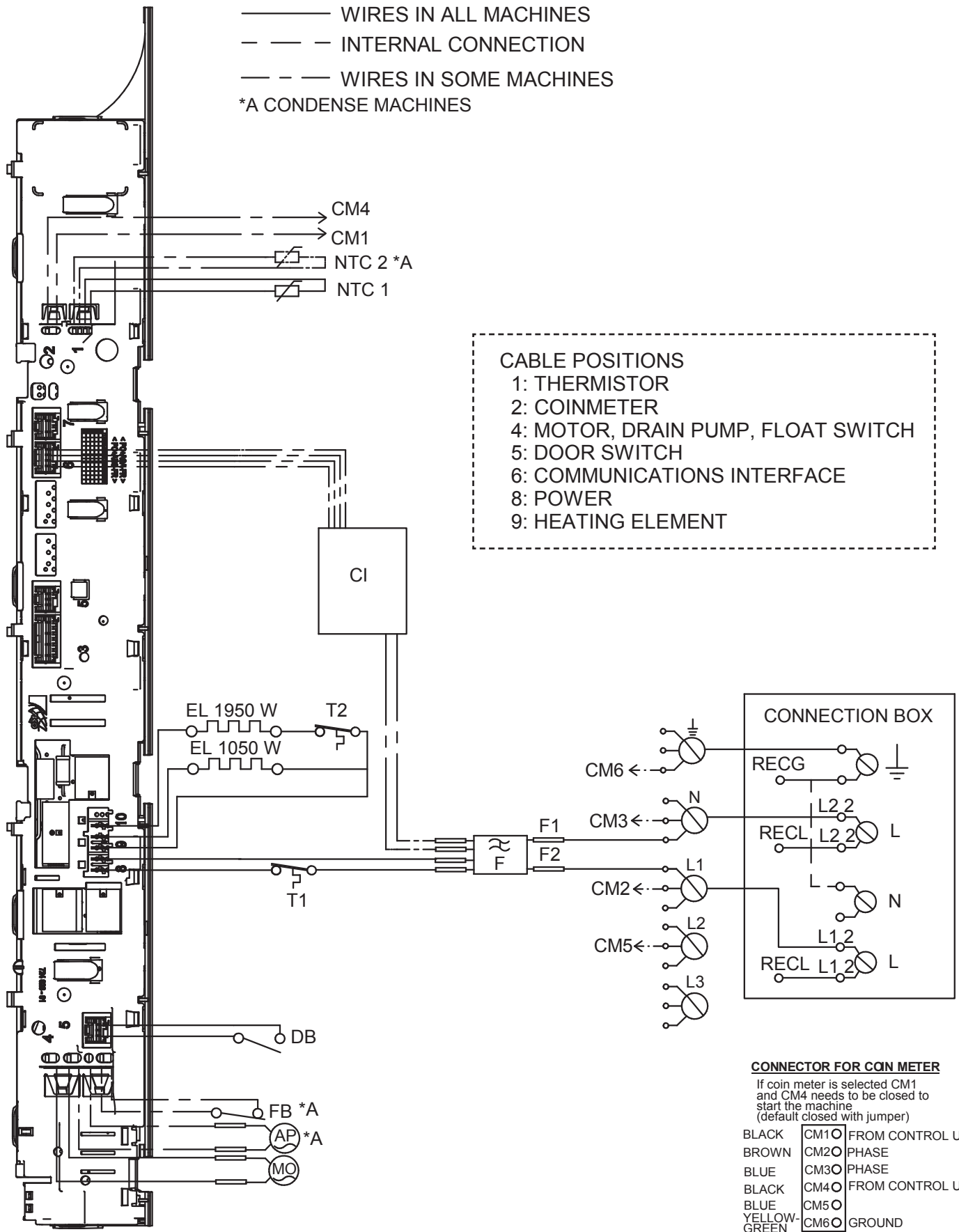

RESISTANCES AT ROOM TEMPERATURE (CA. 20°C/68°F)
 VALUES WITH +/-10% ARE REGARDED AS NORMAL
 COMPONENT

F: RADIO INTERFERENCE SUPPRESSION FILTER	680K Ohm
NTC 1: THERMISTOR 1	4 - 6 K Ohm
NTC 2: THERMISTOR 2:	4 - 6 K Ohm
AP: DRAIN PUMP:	111 Ohm
EL: HEATING ELEMENT 1050W	45.3 Ohm
EL: HEATING ELEMENT 1950W	20.5 Ohm
MO: MOTOR	
T1: THERMOSTAT, OVERHEATING (HEATER)	
T2: THERMOSTAT, OVERHEATING (HEATER)	
FB: FLOAT SWITCH	
DB: DOOR SWITCH	
CI: COMMUNICATIONS INTERFACE	

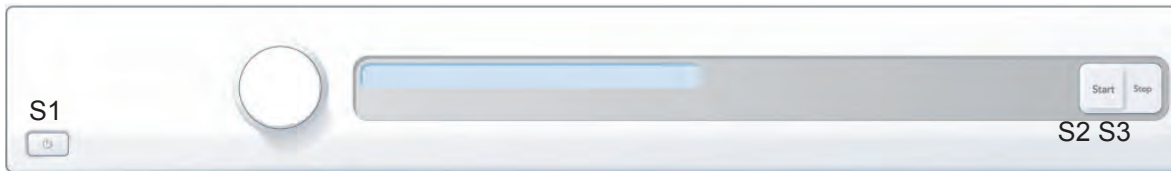

SERVICE MENU

TURN OFF POWER (S1)
 WAIT FOR AT LEAST 5 SEC
 HOLD S2
 TURN ON POWER (S1)
 PRESS S2 5 TIMES TO ENTER SERVICE MENU

PRESS STOP (S3) TO CHANGE MENU STEP
 ROTATE DIAL TO CHANGE IN STEP
 PRESSING START (S2) STORES AND EXITS SERVICE MENU

USER SETTINGS MENU

TURN OFF POWER (S1)
 WAIT FOR AT LEAST 5 SEC
 HOLD S3
 TURN ON POWER (S1)
 PRESS S3 5 TIMES TO ENTER MENU

2011-09-15

CIRCUIT DIAGRAM TD70.C US/CA
80 902 60 - 01

This document must not be copied without our written permission, and the contents thereof must not be imparted to a third party nor be used for any unauthorized purpose. Contravention will be prosecuted.
 Asko Appliances AB

Control unit

Circuit diagram TD70.C HWC

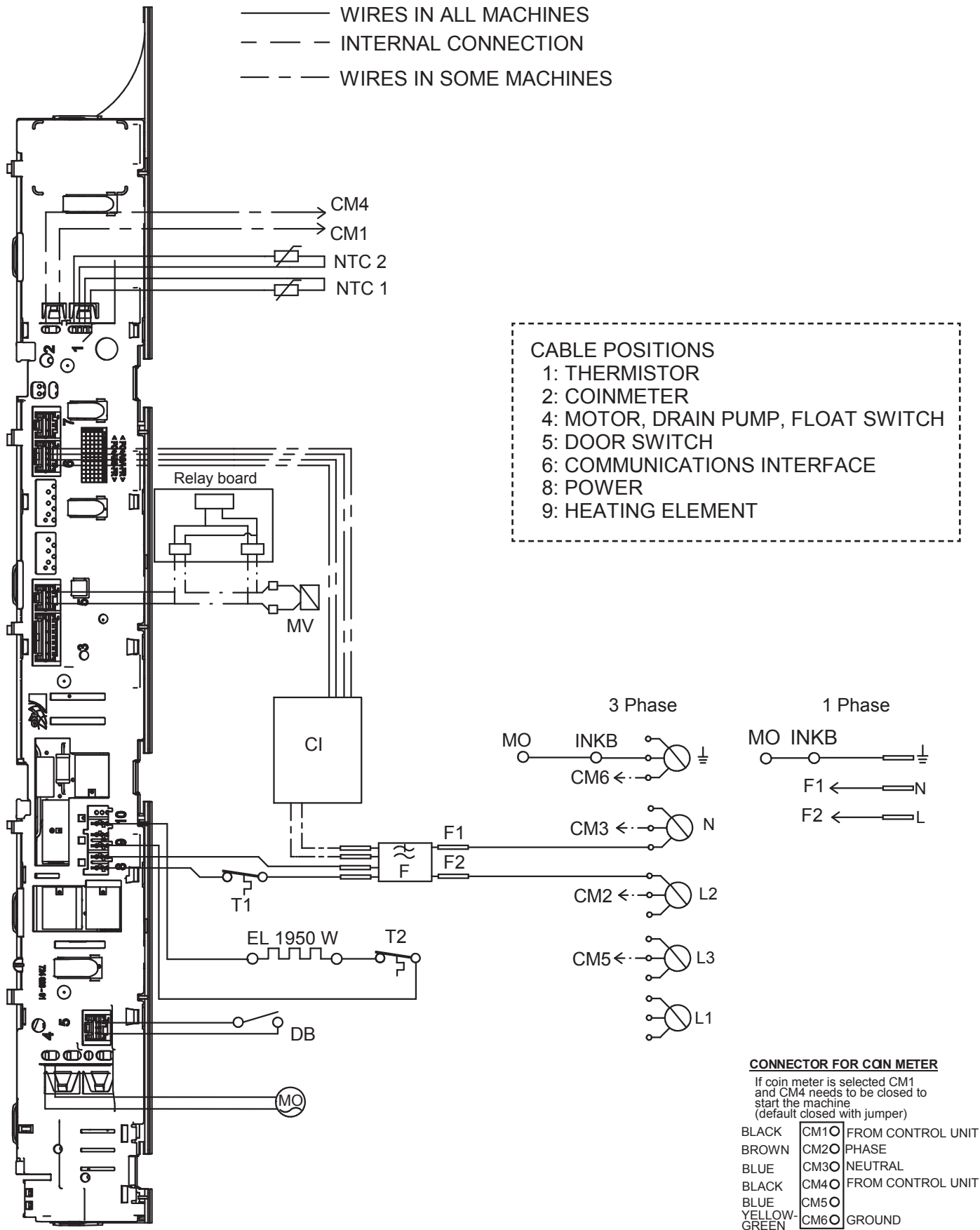

RESISTANCES AT ROOM TEMPERATURE (CA. 20°C/68°F)
VALUES WITH +/-10% ARE REGARDED AS NORMAL
COMPONENT

F: RADIO INTERFERENCE SUPPRESSION FILTER	680K Ohm
NTC 1: THERMISTOR 1	4 - 6 K Ohm
NTC 2: THERMISTOR 2:	4 - 6 K Ohm
EL: HEATING ELEMENT 1950W	20.5 Ohm
MO: MOTOR	
T1: THERMOSTAT	
T2: THERMOSTAT,	
DB: DOOR SWITCH	
CI: COMMUNICATIONS INTERFACE	
MV: MAGNETIC VALVE	866 Ohm

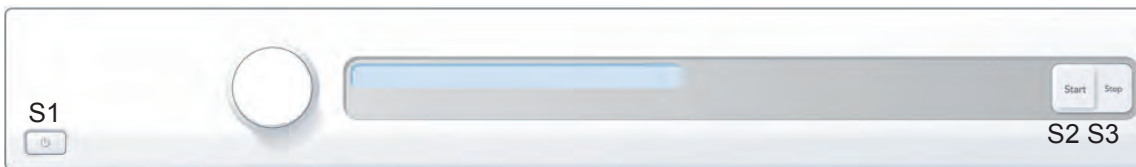

SERVICE MENU

TURN OFF POWER (S1)
WAIT FOR AT LEAST 5 SEC
HOLD S2
TURN ON POWER (S1)
PRESS S2 5 TIMES TO ENTER SERVICE MENU

PRESS STOP (S3) TO CHANGE MENU STEP
ROTATE DIAL TO CHANGE IN STEP
PRESSING START (S2) STORES AND EXITS SERVICE MENU

USER SETTINGS MENU

TURN OFF POWER (S1)
WAIT FOR AT LEAST 5 SEC
HOLD S3
TURN ON POWER (S1)
PRESS S3 5 TIMES TO ENTER MENU

2011-07-07

CIRCUIT DIAGRAM TD70.C HWC
80 902 89 - 00

This document must not be copied without our written permission, and the contents thereof must not be imparted to a third party nor be used for any unauthorized purpose. Contravention will be prosecuted.
Asko Appliances AB

Control unit

Circuit diagram TD70.C HP

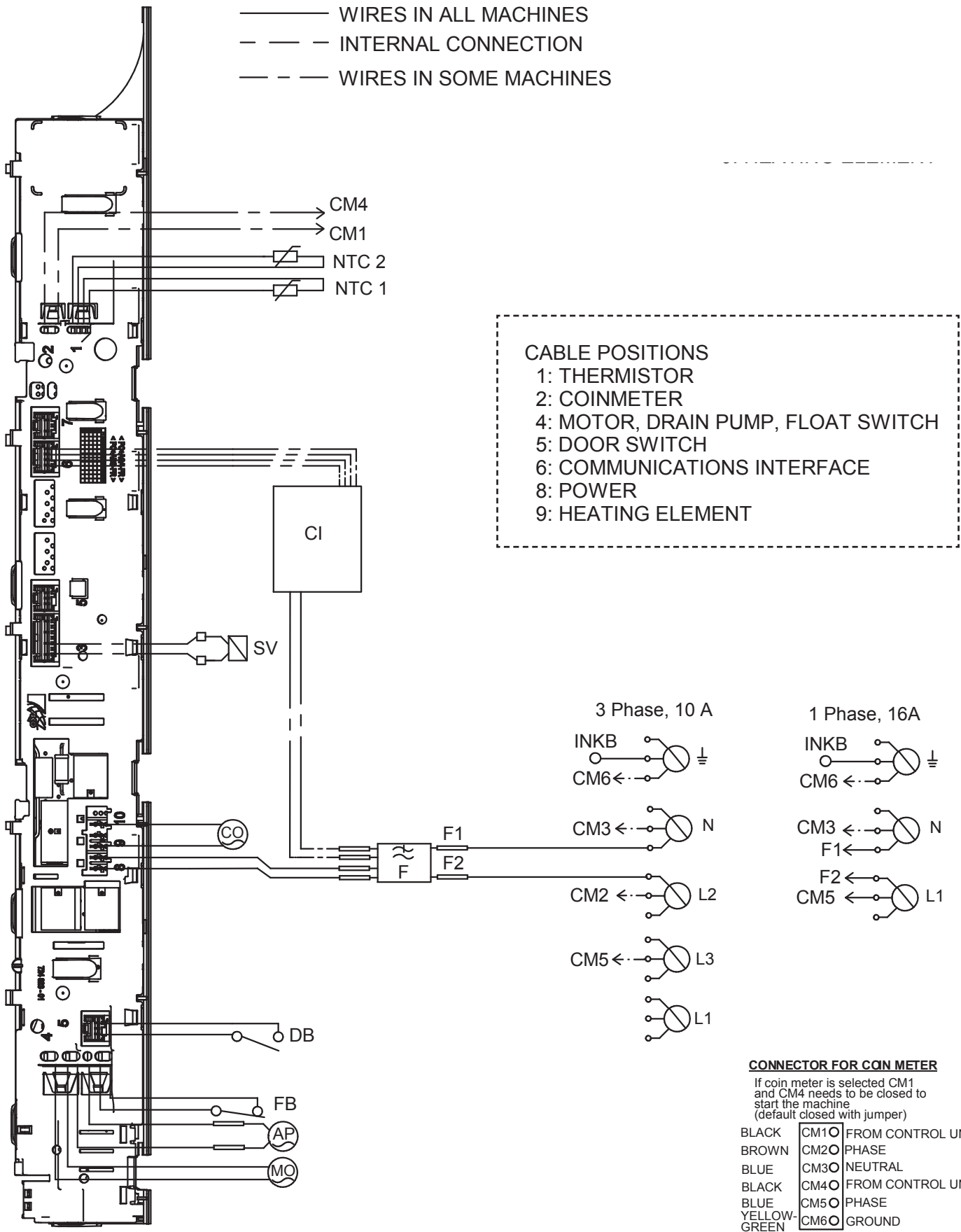

RESISTANCES AT ROOM TEMPERATURE (CA. 20°C/68°F)
VALUES WITH +/-10% ARE REGARDED AS NORMAL
COMPONENT

F: RADIO INTERFERENCE SUPPRESSION FILTER 680K Ohm
NTC 1: THERMISTOR 1 4 - 6 K Ohm
NTC 2: THERMISTOR 2: 4 - 6 K Ohm
AP: DRAIN PUMP: 111 Ohm
CO: COMPRESSOR
MO: MOTOR
FB: FLOAT SWITCH
DB: DOOR SWITCH
CI: COMMUNICATIONS INTERFACE
SV: SWITCHING VALVE

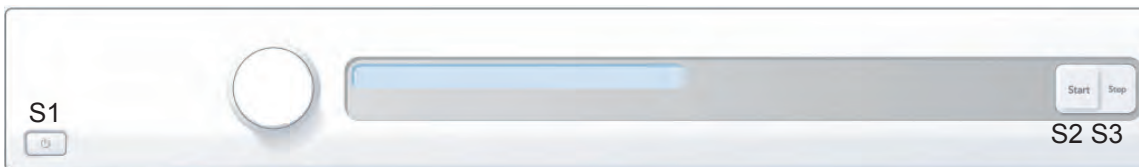

SERVICE MENU

TURN OFF POWER (S1)
WAIT FOR AT LEAST 5 SEC
HOLD S2
TURN ON POWER (S1)
PRESS S2 5 TIMES TO ENTER SERVICE MENU

PRESS STOP (S3) TO CHANGE MENU STEP
ROTATE DIAL TO CHANGE IN STEP
PRESSING START (S2) STORES AND EXITS SERVICE MENU

USER SETTINGS MENU

TURN OFF POWER (S1)
WAIT FOR AT LEAST 5 SEC
HOLD S3
TURN ON POWER (S1)
PRESS S3 5 TIMES TO ENTER MENU

2011-07-07

CIRCUIT DIAGRAM TD70.C HP
80 902 90 - 00

This document must not be copied without our written permission, and the contents thereof must not be imparted to a third party nor be used for any unauthorized purpose. Contravention will be prosecuted.
Asko Appliances AB

Troubleshooting

Fault indicators

In the case of a fault the following fault indicators are shown on the display.

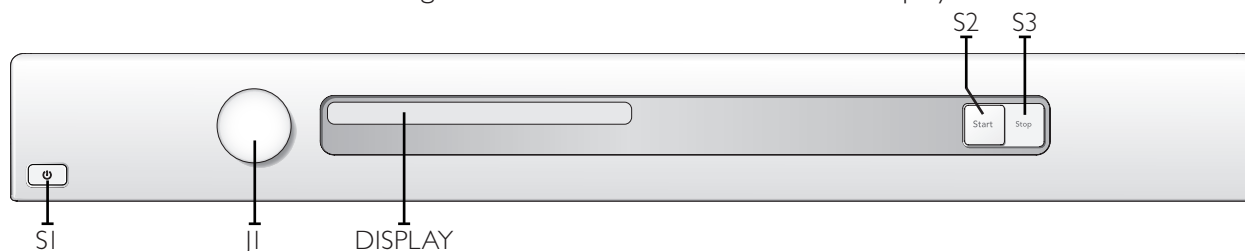

Display	Cause	Action
Over flow fault, Overflow Fault, Over flow fault, Överfyllnad, Overløbsfejl, Overflom, Ylitulviminen, Троп plein, Überlauf, Троппо pieno, Desborde, Перелив воды, Te veel water	The microswitch is opened when a full condensed water tank is detected. Detection begins 30 seconds after the programme starts. If the microswitch is open >30 seconds the programme cycle is stopped.	<p>Check whether the customer has:</p> <ul style="list-style-type: none"> Emptied the tank and restarted the machine. <p>Service action:</p> <ul style="list-style-type: none"> Clean hoses and check voltage and resistance of drainage pump. Check that the float has not got "stuck" and check the function of the microswitch.
Max Program Time, Max program time , Maximal programtid, Maksimal programtid, Maks programtid, Max ohjelma-aika, Durée maxi prog., Tijd overschreden, Tempo max. progr., Duración máx prog., Превышение времени, Max. Programmzeit	<p>The programme cycle time exceeds 200 minutes. The cycle is stopped and the programme is reset.</p> <p>High ambient temperature combined with low heater output and low drying temperature leads to poor condensation formation.</p> <p>Poor condensation due to blocked external air</p>	<p>Check whether the customer has:</p> <ul style="list-style-type: none"> Tried spinning at a higher speed. Had the machine switched off for 30 minutes before restarting. Good ventilation in the room. <p>Service action:</p> <ul style="list-style-type: none"> Ensure that the external air has free passage.
Thermistor fault, Thermistor Fault, Thermistor fault, Termistorfel, Termostat fejl, Termistor, Termistorivika, Défaut , Termistorfehler, Termistore , Fallo , Термистор, Temp. sensor fout	<ol style="list-style-type: none"> Thermistor circuit open Thermistor malfunction 	<p>Service action:</p> <p>Check the thermistor. Replace if necessary.</p>
Clean condenser, Rengör kondensator, Rens kon.sator, Rens kon.sator, Puhdista lauhdutin, Nettoyage condenseur, Reinigen kondensator, Pulizia condensatore, Limpiar condensador, Очистить конденсатор, Kondenser reinigen	1. Displayed according to the interval set in the service menu.	<p>Check whether the customer has:</p> <ul style="list-style-type: none"> Cleaned the condenser and the filter. Cleaned the other air passages.
Clean Lint Filter, Clean Lint Filter, Rengör filtret, Rengør fnugfilter, Rens filter, Puhdista sihti, Nettoyage filtre, Reinig filter, Pulizia filtro, Limpie el filtro, Очистить фильтр, Sieb reinigen	1. Displayed according to the interval set in the service menu.	<p>Check whether the customer has:</p> <ul style="list-style-type: none"> Cleaned the lint filter.
Clean auto filter, Rengör autofilter, Rens aut. filter, Rengjøring autofilter, Puhd. autom. suodatin, Nett. filtre auto, Auto. filter reinigen, Pulizia filtro auto, Limpiar el autofiltro, Очистите автофильтр, Autofilter reinigen	1. Displayed according to the interval set in the service menu.	<p>Check whether the customer has:</p> <ul style="list-style-type: none"> Cleaned the water filter.
Clean filter, Rengör filter, Rens filter, Rengjøring filter, Puhd. suodatin, Nett. Filtre, Filter reinigen, Pulizia filtro, Limpiar el filtro, Очистите фильтр, Filter reinigen	1. Displayed according to the interval set in the service menu.	<p>Check whether the customer has:</p> <ul style="list-style-type: none"> Cleaned the evaporator filter and the evaporator.

After carrying out corrective actions as above, reset the fault indication on the display by switching off the machine at the main power switch.

Service menu

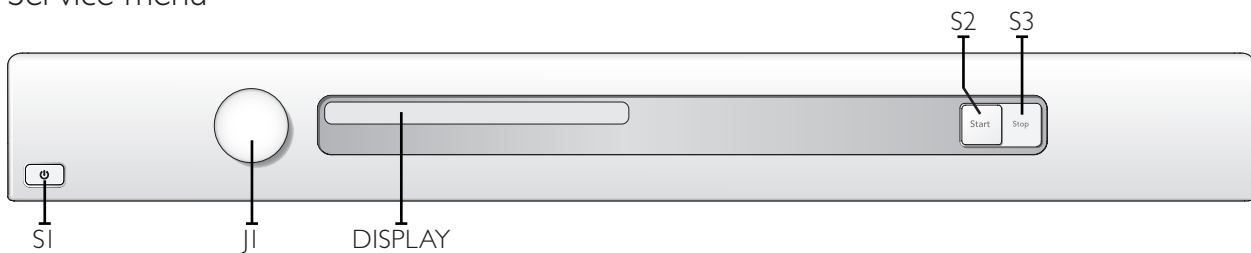

Opening the service menu	
	Check that the machine is switched off. Otherwise switch off the main power by pressing the main power switch (SI). Press and hold the Start button (S2) while turning on the main power with the main power switch (SI).
	Press the Start button (S2) 5 times within 5 seconds. The service menu is now activated, as seen in the display window. The service menu can be closed by turning off the power with the main power switch (SI).
	Press the Stop button (S3) to navigate the menu system step by step.
	Turn the programme selector (JI) to make selections from the menus. Confirm the selection and continue to the next menu by pressing the Stop button (S3).
	Press the Start button (S2) to confirm the settings and exit the service menu.

Turn/ Push	Display	Comments/instructions
	SP: xxxx	Date the software was programmed (Year_Week)
	CM: xxxx	Date of manufacture of the control unit (Year_Week)
	SV: xxxxxxxxxx	Software version number
	NCP0: xxxxxxxxxx	Total number of cycles run
	NCP1: xxxxxxxxxx	Number of cycles run for Programme 1
	NCP2: xxxxxxxxxx	Number of cycles run for Programme 2
	NCP3: xxxxxxxxxx	Number of cycles run for Programme 3
	NCP4: xxxxxxxxxx	Number of cycles run for Programme 4
	NCP5: xxxxxxxxxx	Number of cycles run for Programme 5
	NCP6: xxxxxxxxxx	Number of cycles run for Programme 6
	NCP7: xxxxxxxxxx	Number of cycles run for Programme 7
	"Fault No. of cycles (1)"	Last three faults and number of cycles (when the fault occurred) shown. A total reset deletes the fault indications from the system. If the same fault recurs at different times, this is shown, but only once in the list.
	"Fault No. of cycles (2)"	
	"Fault No. of cycles (3)"	

TRACKING DATA

FAILURE REED OUT

Panel key: S = Push button, J = Knob

Service menu cont.

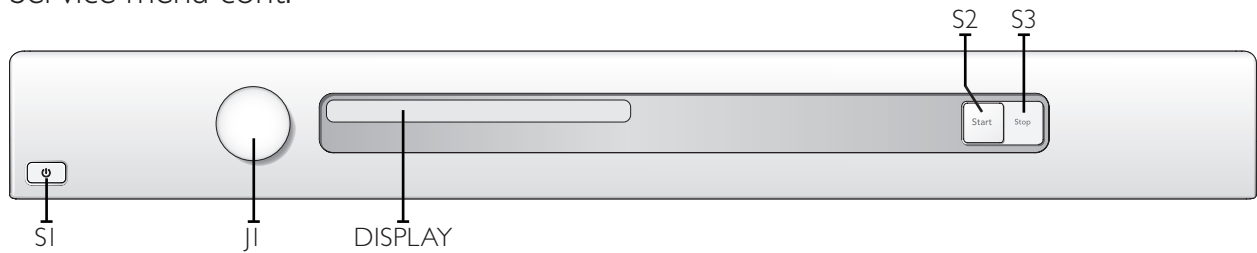

Turn/ Push	Display	Comments/instructions		
	Test	No component tested	DIAGNOSTICS	
	Test motor	The motor runs at normal speed		
	Test heater 1	The motor runs at normal speed. Heating element 1 is switched on and off by the CU depending on the values registered by thermistors 1 and 2. Max. temp. 70°C. (Only if setting for heat pump is <i>Heat Pump Off</i>)		
	Test heater 2	The motor runs at normal speed. Heating element 2 is switched on and off by the CU depending on the values registered by thermistors 1 and 2. Max. temp. 70°C. (Only for condenser and vented machines and where setting for steam is <i>Steam Off</i>)		
	Testing compressor	Temperature sequence on (only machines with heat pump)		
	Testing switching valve	Switching valve on (only machines with heat pump)		
	Testing fan/HWC	Fan/Valve on (Fan only for machines with heat pump and Valve only for HWC)		
	Test drain	The condensed water pump starts (only condenser machines and heat pump)		
	Test buzzer	Buzzer on continuously		
	Dry level 0	Drying time extended by 0, default setting	DRY LEVEL	
	Dry level +5	Drying time extended by 5 min		
	Dry level +10	Drying time extended by 10 min		
	Dry level +15	Drying time extended by 15 min		
	Dry level +20	Drying time extended by 20 min		
	Auto extra dry	Off	Setting to make Programme 1 - Auto extra dry selectable/non-selectable in the programme menu.	BLOCK PROGRAMMS
		On		
	Auto dry	Off	Setting to make Programme 2 - Auto dry selectable/non-selectable in the programme menu.	
		On		
	Auto normal dry	Off	Setting to make Programme 3 - Auto normal dry selectable/non-selectable in the programme menu.	
		On		
	Auto extra dry	Off	Setting to make Programme 4 - Auto extra dry, low temperature selectable/non-selectable in the programme menu.	
		On		
	Auto dry	Off	Setting to make Programme 5 - Auto dry, low temperature selectable/non-selectable in the programme menu.	
		On		
	Auto normal dry	Off	Setting to make Programme 6 - Auto normal dry, low temperature selectable/non-selectable in the programme menu.	
		On		
	Auto iron dry	Off	Setting to make Programme 7 - Auto iron dry, low temperature selectable/non-selectable in the programme menu.	
		On		
	Coin Off	Setting for coin operations Off, default setting	COIN	
	Coin On	Setting for coin operations On		

Service menu cont.

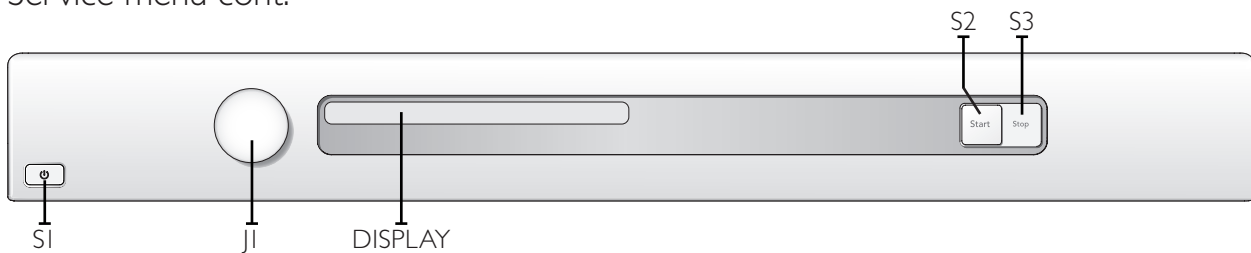

Turn/ Push	Display	Comments/instructions	
	Filter Interval 2	Interval for indication "Clean filter", default setting (every 2nd cycle)	CLEAN FILTER
	Filter Interval 3	Interval for indication "Clean filter" (every 3rd cycle)	
	Filter Interval 4	Interval for indication "Clean filter" (every 4th cycle)	
	Filter Interval 5	Interval for indication "Clean filter" (every 5th cycle)	
	Filter Interval 6	Interval for indication "Clean filter" (every 6th cycle)	
	Filter Interval 7	Interval for indication "Clean filter" (every 7th cycle)	
	Filter Interval 8	Interval for indication "Clean filter" (every 8th cycle)	
	Filter Interval 9	Interval for indication "Clean filter" (every 9th cycle)	
	Filter Interval 10	Interval for indication "Clean filter" (every 10th cycle)	
	Filter Interval 1	Interval for indication "Clean filter" (every cycle)	
	Filter Interval 0	Interval for indication "Clean filter" (not shown)	
	Condense Interval 0	Interval for indication "Clean condense", default setting (not shown)	CLEAN CONDENSE (Condenser)
	Condense Interval 1	Interval for indication "Clean condense" (every 100th cycle)	
	Condense Interval 2	Interval for indication "Clean condense" (every 200th cycle)	
	Condense Interval 3	Interval for indication "Clean condense" (every 300th cycle)	
	Condense Interval 4	Interval for indication "Clean condense" (every 400th cycle)	
	Condense Interval 5	Interval for indication "Clean condense" (every 500th cycle)	
	Condense Interval 6	Interval for indication "Clean condense" (every 600th cycle)	
	Condense Interval 7	Interval for indication "Clean condense" (every 700th cycle)	
	Condense Interval 8	Interval for indication "Clean condense" (every 800th cycle)	
	Condense Interval 9	Interval for indication "Clean condense" (every 900th cycle)	
	Condense Interval 10	Interval for indication "Clean condense" (every 1000th cycle)	
	Auto filter Interval 2	Interval for indication "Clean auto filter", default setting (every 20th cycle)	CLEAN AUTO FILTER
	Auto filter Interval 3	Interval for indication "Clean auto filter" (every 30th cycle)	
	Auto filter Interval 4	Interval for indication "Clean auto filter" (every 40th cycle)	
	Auto filter Interval 5	Interval for indication "Clean auto filter" (every 50th cycle)	
	Auto filter Interval 6	Interval for indication "Clean auto filter" (every 60th cycle)	
	Auto filter Interval 7	Interval for indication "Clean auto filter" (every 70th cycle)	
	Auto filter Interval 8	Interval for indication "Clean auto filter" (every 80th cycle)	
	Auto filter Interval 9	Interval for indication "Clean auto filter" (every 90th cycle)	
	Auto filter Interval 10	Interval for indication "Clean auto filter" (every 100th cycle)	
	Auto filter Interval 1	Interval for indication "Clean auto filter" (every 10th cycle)	
	Auto filter Interval 0	Interval for indication "Clean auto filter" (not shown)	

Panel key: S = Push button, J = Knob

Service menu cont.

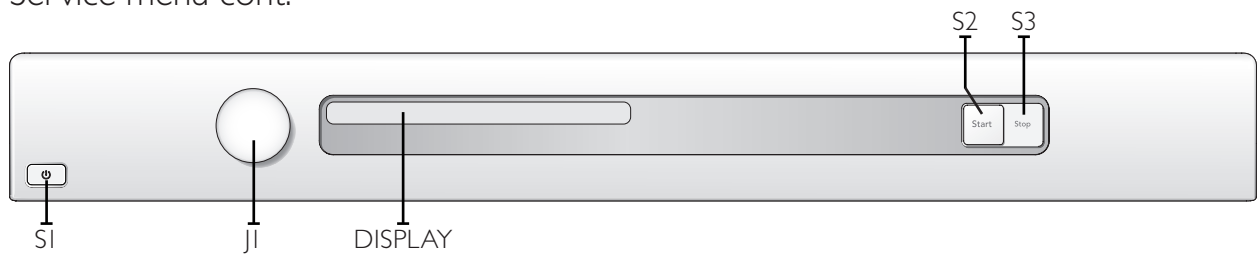

Turn/ Push	Display	Comments/instructions	
	Condense Interval 0	Interval for indication "Clean condense", default setting (not shown)	CLEAN CONDENSE (Heat Pump)
	Condense Interval 1	Interval for indication "Clean condense" (every 100th cycle)	
	Condense Interval 2	Interval for indication "Clean condense" (every 200th cycle)	
	Condense Interval 3	Interval for indication "Clean condense" (every 300th cycle)	
	Condense Interval 4	Interval for indication "Clean condense" (every 400th cycle)	
	Condense Interval 5	Interval for indication "Clean condense" (every 500th cycle)	
	Condense Interval 6	Interval for indication "Clean condense" (every 600th cycle)	
	Condense Interval 7	Interval for indication "Clean condense" (every 700th cycle)	
	Condense Interval 8	Interval for indication "Clean condense" (every 800th cycle)	
	Condense Interval 9	Interval for indication "Clean condense" (every 900th cycle)	
	Condense Interval 10	Interval for indication "Clean condense" (every 1000th cycle)	
	Heat pump Off	Setting for Heat pump Off, default setting	HEAT PUMP
	Heat pump On	Setting for Heat pump On	
	Auto filter Off	Setting for self-cleaning filter Off, default setting	AUTO FILTER
	Auto filter On	Setting for self-cleaning filter On	
	Total reset	Press the Stop button (S3) to return to the beginning of the service menu.	TOTAL RESET
		Total reset if Start button (S2) is pressed. After restart language setting is shown. Turn programme selector (JI) to select language and confirm by pressing Start button (S2).	

Panel key: S = Push button, J = Knob

Service and installation

Replacing the panel and the control unit

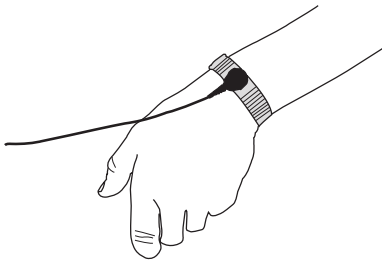
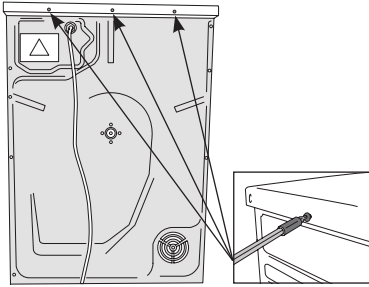
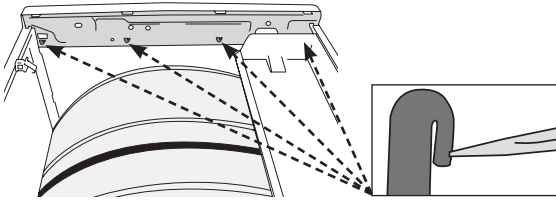
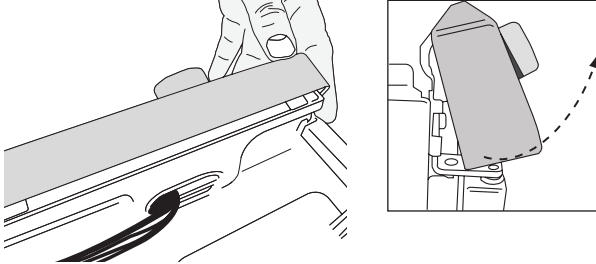
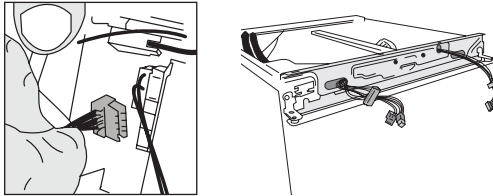
Instructions	Illustration
<p>1. Attach the anti-static wristband to a part of the machine that is earthed!</p> <p>NOTE! An anti-static wristband must be used, otherwise you risk destroying the control card.</p>	
<p>2. Unscrew the top cover.</p>	
<p>2. Carefully press the catches that secure the panel to the front support. Release the catches from the front support by working the panel outwards.</p>	
<p>3. Detach the panel by angling and pulling it carefully outwards at the lower edge.</p> <p>Note: Be careful not to damage the wiring!</p>	
<p>4. Carefully disconnect the wiring from the control unit.</p>	

Service and installation

Replacing the panel and the control unit

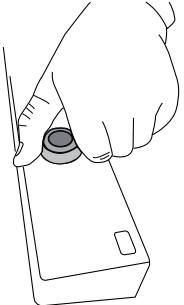
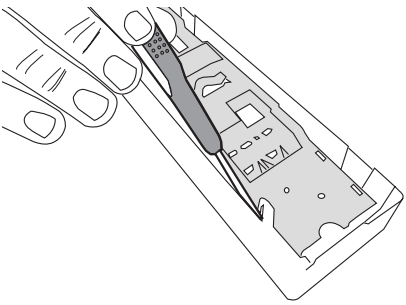
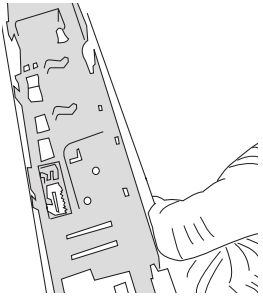
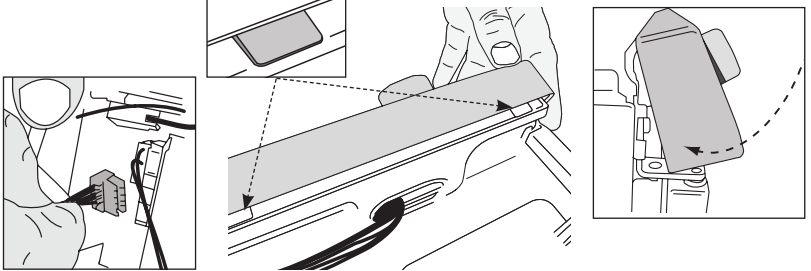
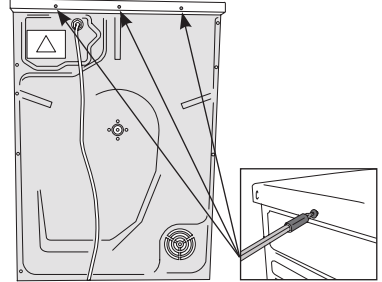
Instructions	Illustration
<p>6. Carefully pull the programme selector from the panel.</p>	
<p>7. Use a screwdriver to free the control card from the panel. NOTE! The control card must be placed in an ESD-safe bag.</p>	
<p>8. Check that the push button, lens and decorative inlay are in place. Now carefully press the new control card into place.</p>	
<p>9. Attaching the panel: Attach all wiring to the appropriate connectors on the control card.</p> <p>Angle the panel outwards and place the mounting plates in the corresponding grooves in the front frame. Angle the panel downwards and secure it with the catches</p> <p>Note: Be careful not to damage the wiring!</p>	
<p>10. Screw the top cover into place.</p>	

Service and installation

Transporting a tumble dryer with a heat pump

Machines with a heat pump must only be transported upright or placed on the left side when viewed from the front. In extreme cases, laying the machine on any other side, or transporting it in an incorrect manner, may result in making the machine unusable. **Let the machine stand for 24 hours after transport before use, otherwise the heat pump may be damaged.**



Examples of incorrect transport methods

Machines with a heat pump must only be transported as shown above.

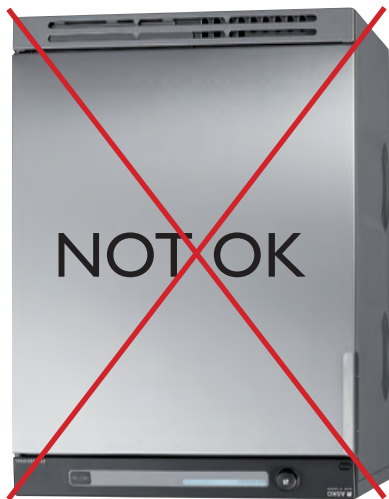

Let the machine stand for 24 hours after transport before use, otherwise the heat pump may be damaged.

