



2007 18 Inch Built-In Dishwasher Service Manual



Product No.	FMB330RGB0	FMB330RGC0	FMB330RGS0
Series	18" Built-in	18" Built-in	18" Built-in
Color	black	stainless	white
Owner's Guide English	672060102191	672060102191	672060102191
Owner's Guide Spanish	672060102193	672060102193	672060102193
Owner's Guide French	672060102220	672060102220	672060102220
Service Data Sheet	672060709962	672060709962	672060709962
Energy Guide	672060901400	672060901400	672060901400
Installation Instructions	672060120311	672060120311	672060120311
Market	North America	North America	North America

SAFE SERVICING PRACTICES - ALL APPLIANCES

To avoid personal injury and/or property damage, it is important that Safe Servicing Practices be observed. The following are some limited examples of safe practices:

1. **DO NOT** attempt a product repair if you have any doubts as to your ability to complete it in a safe and satisfactory manner.
2. Before servicing or moving an appliance:
 - Remove the power cord from the electrical outlet, trip the circuit breaker to the OFF position, or remove the fuse.
 - Turn off the gas supply.
 - Turn off the water supply.
3. Never interfere with the proper operation of any safety device.
4. **USE ONLY REPLACEMENT PARTS CATALOGED FOR THIS APPLIANCE. SUBSTITUTIONS MAY DEFEAT COMPLIANCE WITH SAFETY STANDARDS SET FOR HOME APPLIANCES.**
5. **GROUNDING:** The standard color coding for safety ground wires is **GREEN**, or **GREEN with YELLOW STRIPES**. Ground leads are not to be used as current carrying conductors. It is **EXTREMELY** important that the service technician reestablish all safety grounds prior to completion of service. Failure to do so will create a hazard.
6. Prior to returning the product to service, ensure that:
 - All electrical connections are correct and secure
 - All electrical leads are properly dressed and secured away from sharp edges, high-temperature components, and moving parts
 - All non-insulated electrical terminals, connectors, heaters, etc. are adequately spaced away from all metal parts and panels
 - All safety grounds (both internal and external) are correctly and securely connected
 - All panels are properly and securely reassembled

ATTENTION!!!

This service manual is intended for use by persons having electrical and mechanical training and a level of knowledge of these subjects generally considered acceptable in the appliance repair trade. Electrolux Home Products cannot be responsible, nor assume any liability, for injury or damage of any kind arising from the use of this manual.

© 2007 Electrolux Home Products, Inc.

Table of contents

Safe Servicing Practices - All Appliances	2	Disassembly and Service	11
Table of Contents	3	Outer Door Panel	11
18 Inch Stainless Steel Tub Dishwasher	4	Console.....	11
Timer	4	Timer	11
Testing the timer.....	4	Door Latch	11
Selector Switch.....	4	Selector Switch.....	11
To test the selector switch	5	Vent Housing and Vent Grate.....	12
Door Latch	5	Dispenser.....	12
Testing the door switches	5	Lower Spray Arm.....	12
Detergent and Rinse Aid Dispenser	5	Upper Rack	12
Dispenser Operation	6	Center Spray Arm	12
Testing the dispenser.....	6	Door Seal.....	12
Wash Operation	6	Water Valve.....	13
Wash Motor	6	Thermostats and Mounting Bracket	13
Drain Pump.....	7	Pressure Switch.....	14
Water Valve.....	8	Door Spring	14
Lower Spray Arm.....	8	Hinge Assembly.....	14
Center Spray Arm	8	Drain Pump.....	15
Filters.....	8	Wash Motor and Pump Assembly.....	15
Thermostats.....	9	Heater	16
Control Thermostat.....	8	Sump	16
Safety Thermostat	8	Parts List Breakdown	17
Control and Safety Thermostats in the Mount Assembly	8	Door/Control Panel	17
Heater	8	Tub.....	19
Tub and Door Attachments	8	Motor & Pump.....	21
Air Gap	8	Racks.....	23
Sump.....	9	Service Information	25
Delivery Tube.....	9	Service Information	25
Door Hinge and Door Springs	9	Wiring Diagram.....	26
Door Seal.....	9		
Tub Rollers	9		
Vent	10		

18 Inch Stainless Steel Tub Dishwasher

The stainless steel tub 18 inch under counter and portable dishwasher offers a completely new wash system, door hinge and spring assembly, with the addition of a separate drain pump, and an all new water overflow system. This manual will describe how to service, diagnose, and repair or replace components on this unit.

Timer

An electrical mechanical timer controls all operations and functions on this unit. The user can select a number of different cycles depending on the needs of the load to be cleaned. This model also has the flexibility to offer a rinse only and a plate warmer setting along with up to a three hour delay wash setting. The timer controls all of the electrical operation of the dishwasher for any of the cycles selected. The sequence of the different cycles can be found in the cycle chart supplied with the product and a copy also found in this manual.

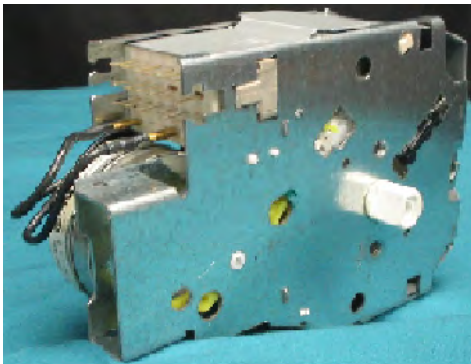

To assist in determining problems with the timer, or timer operation, the use of the product wiring diagram and the cycle sequence chart will help in determining when contacts open or close for the different electrical components.

Testing the timer

1. Check power to the product at the junction box, then at the door switches mounted on the door latch assembly.
2. Set the timer to the Heavy Wash setting. Check for power from both door switches to the timer to make sure the timer disconnect block is locked in to the timer properly.
3. All of the following checks should be done with the power disconnected and using an ohm meter for safety.
4. Use the wiring diagram and the sequence chart to check for proper opening and closing of the different contacts in the timer.
5. After all needed checks have been completed, power can again be applied and the operation of the timer motor can be checked. The timer motor will start after the knob is moved from the off setting.
6. It is best to advance the timer with the door open.

This will reduce burning of the timer contacts.

7. Return the timer to the Heavy Wash setting, close the door and allow the timer to advance. Referring to the sequence chart will tell the length of time between advancements of the timer.

If a timer contact fails to open or close as shown in the sequence chart, or a burnt contact is found, the timer will need to be replaced.

If the timer does not advance automatically according to the sequence chart, the timer will need to be replaced.

Selector Switch

The selector switch allows the user to change a cycle by adding or subtracting options as they so desire. There is an option for a high temperature wash and /or a no heat dry.



When the high temperature wash cycle is selected, the timer advances the cycle up to the main wash section of the wash cycle, then near the end of this section, or when the indicator on the timer knob is straight down and again just before the plate warmer location, the timer will pause, but the wash motor will continue to spray water.

During this pause the heater will increase the wash water temperature until a control thermostat located on the under side of the tub closes. This restarts the timer motor and the cycle continues. The length of time for this option can vary depending on incoming water temperature and the make up of the dish load.

The no heat dry option disconnects power to the heater once the timer reaches the dry section of a wash cycle. This option only removes power to the heater in the dry cycle and does not affect any other heater operations.

The selector switch is a multi function push button type switch. When a pad is pressed a red plastic flag will appear in the window above the pad to show it has been pressed. This flag is not a light but will show as red. The selection of these options can be made at any time up to the point in the cycle they will affect the operation of the cycle.

To Test the Selector Switch

1. It is best to disconnect power from the dishwasher when testing these switches.
2. Always remove one wire from the switch you are testing to be sure you are getting an accurate reading.
3. Check the wiring diagram to see which contact is closed, then check the contact with an ohm meter.

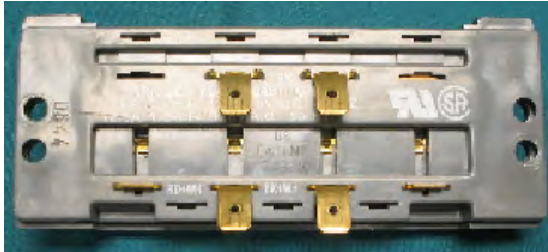

Door latch

The door latch and switch assembly holds the inner door panel tight against the tub-door seal. The door switches mounted to the door latch make sure all operation of the dishwasher stops if the door is opened. The primary purpose of the door latch and switch assembly is to increase the safety for the user and to protect their property. The door latch has two microswitches, one mounted to each side of the latch. For safety, both sides of the electrical power to the dishwasher will be broken when the door is opened.

As the door moves to the tub the latch inside the console pushes into a strike mounted to the top of the tub which pushes back a cam inside the latch. This cam pushes against a spring that in turn lowers an actuator over the two normally open microswitches, closing the switches and starting the dishwasher. The latch and door switches are an assembly and can't be replaced separately.

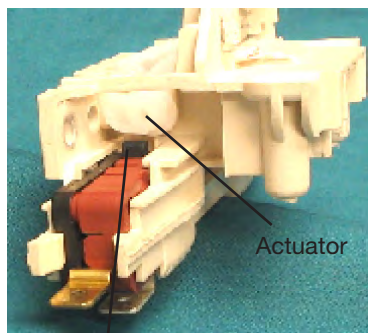
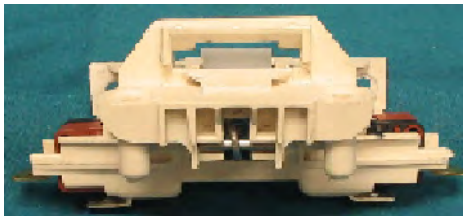

If door is open the door switches are open

Door strike

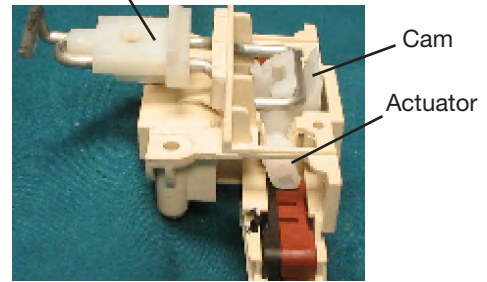

Latch in the closed position

Testing the door switches

1. Disconnect power to the unit for safety
2. When checking a switch always remove one wire from the switch.
3. Now check the switch for continuity with the latch closed then for no continuity with the switch open.

Detergent and Rinse Aid Dispenser

The detergent and rinse aid dispenser consists of two dispensers combined in one housing that are controlled with one wax motor actuator. The first time the timer energizes the actuator, the cover over the detergent side of the dispenser opens dispensing detergent for the main wash cycle. The second time the actuator is energized, the rinse aid is released in the final rinse cycle. The detergent side of the dispenser has one cup for detergent. After it is filled with the proper amount of detergent and the lid is closed, the pre-wash detergent can be placed in a recessed area molded into the outside of the cover. When the dishwasher door is closed the pre-wash detergent falls directly into the tub as the cycle begins. The rinse aid section has a clear indicator to show the presence of agent in the dispenser. There is also an adjustable hub inside the dispenser, visible by removing the cap, to control the amount of agent dispensed. The detergent and rinse aid dispenser is replaced as a complete assembly. The cap for the rinse aid dispenser is the only part available separately.



Dispenser Operation

The detergent dispenser cover is opened manually by pressing the spring loaded thumb release located at the bottom of the cover. After the proper amount of detergent is added close and lock the cover. Once the cycle reaches the main wash, the timer applies power to the wax motor actuator. The plunger of the wax motor extends, pressing down on a pivot arm attached to the latch for the cover. This releases the cover to dispense the detergent. At the same time, on the opposite end of this pivot arm, a pin rides up in the actuating arm for the rinse aid dispenser.

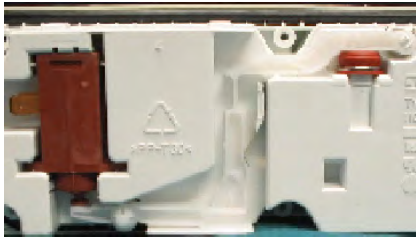

As the timer advances power is removed from the wax motor, the plunger of the wax motor retracts, now the pin at the opposite end falls in the rinse aid actuator. As it does it follows a track down the back side of the actuator to the bottom. The dispenser is now ready to dispense the rinse aid. The timer again applies power to the wax motor, extends the pivot arm raising the rinse aid actuator to release rinse aid into the dishwasher. Finally, power is removed. As the wax motor retracts, the pivot arm falls on a leaf spring mounted to the side on the dispenser that forces the actuator arm over to the starting position for the next cycle.

Testing the Dispenser

The dispenser wax motor is activated by 120 volts and can be function tested outside the product with an approved service cord. When operating the dispenser with a service cord be careful the wax motor will become very hot when power is applied. This can cause a burn if touched.

1. Attach a service cord to the wax motor
2. Apply power and allow actuator to fully extend.
3. Disconnect power allow actuator to completely retract
4. Repeat to actuate rinse aid dispenser.

Wash operation

After the dishwasher is loaded, the proper amount of detergent needs to be added to the detergent dispenser, then close and latch dispenser cover. Detergent can now be added to the top of the cover for pre wash if desired. Next turn the timer to the desired cycle before closing the door of the dishwasher. After closing the door the desired cycle starts. All cycles start first by running the drain pump. This removes any water that may be in the sump after loading the unit. At the completion of this drain cycle there will be a pause before the unit starts to fill, this unit pauses after each drain cycle.

The fill cycle starts with the timer activating the water valve putting water into the unit. A hose from the water valve carries water to the top of the air gap, which is mounted to the right side of the tub, from the air gap

it exits through a different hose attached to the sump just below the filter. The total fill time is 30 seconds and the amount of water entering the tub is approximately 1 gallon. As a point of reference, the water level in the tub at the conclusion of the fill will be just under the heater. When the fill is completed the timer again pauses before the wash motor starts. The timer starts the wash motor and water is sprayed from both arms simultaneously. The heater of this dishwasher is used at varying times throughout the cycle to increase water temperature. If so desired, a high temperature wash option can be selected. The high temperature wash option works by pausing the timer motor to allow the heater to increase water temperature. There are two pauses in the cycle, the first is after the detergent dispenser is opened in the main wash cycle and the second after the rinse aid has been dispensed. These heat delays pause the timer, by stopping the timer motor, until the control thermostat senses the proper temperature then closes which restarts the timer motor and the cycle continues. This thermostat is mounted to the bottom of the tub just to the left of the sump. Finally, in the dry portion of the cycle the heater is cycled on and off to aid in drying. While in the dry cycle the drain pump will be activated to remove any remaining water from the tub.

Wash motor

The wash motor and pump are one assembly mounted to the left of the sump. The motor is a single speed capacitor start motor, with a clockwise rotation facing the front of the pump. The pump inlet acts as the front mount for the assembly. The back is attached to the rear frame with a mounting bracket and a rubber grommet. Water enters the front of the wash pump and exits through two ports. One supplies water to the lower spray arm. The second supplies the delivery tube, attached to the rear of the tub, which supplies water to the center spray arm. The motor also has an internal thermal auto reset overload for motor protection.

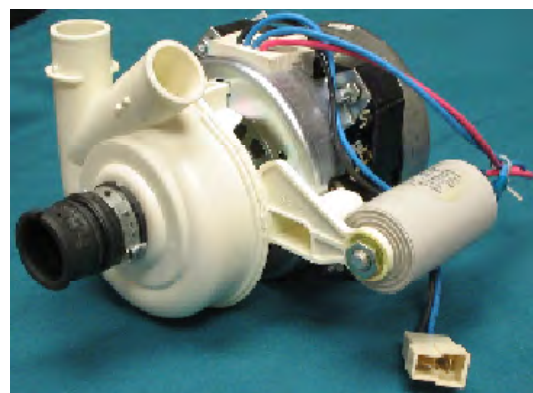

Drain pump

The drain pump is mounted to the right side frame facing forward. A hose from the bottom of the sump is attached to the front of the pump. The discharge of the drain pump has flapper check valve to prevent drain water from backing into the tub when the dishwasher is idle. The drain motor is a wet rotor, magnet induction, design and is dual directional to help prevent being locked up by foreign material entering the pump. The pump housing may be removed for cleaning.



Water valve

The water valve is an electrically operated shut off valve. The valve is designed for incoming water pressure from 20 to 120 psi. The valve has a built-in flow restrictor to regulate the rate of water flow into the dishwasher. The amount of water used in this unit will be approximately one gallon per fill.



Overflow protection is accomplished with a pressure switch mounted to the right side frame behind the junction box. The pressure switch has one normally closed contact for the water valve and one normally open contact for the drain pump. A pressure tube from the switch loops up the right side of the tub to the top of the water inlet assembly then to an air chamber on the front of the sump. As the water level in the tub rises, air trapped in the sump air chamber applies pressure on the pressure switch which

in turn closes the contact to the drain pump draining the tub.



Lower Spray Arm

The lower spray arm turns in a clockwise direction, spraying up into the lower rack. The arm is attached to the spray arm support with a locking ring. To remove, hold the arm and turn the lock clockwise. When reinstalling the spray arm turn the lock all the way counterclockwise until it is fully locked in place.

Center Spray Arm



Lower Spray Arm

Center Spray Arm

The center spray arm turns counter clockwise spraying into the upper rack. The arm has a locking nut holding it to the delivery tube. To remove turn the lock nut clockwise looking down from the upper rack. To reinstall hold arm into tube and turn the lock nut counterclockwise.

Filters

This dishwasher incorporates 3 filters working together to keep food and food particals from the water being sprayed on the dishes. The stainless steel filter is recessed into the tub bottom and covers the complete sump. This filter is made with a pattern of very small holes to prevent small food particals from passing through. Water that passes through this filter will go directly into the wash pump and sprayed onto the dishes.

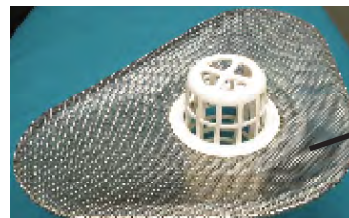

Sump Filter

The next filter passes through the center of the stainless steel filter and has larger opening. This filter extends all the way to the bottom of the sump and seats into the center of the sump where the water exits into the drain pump. As food and other items are removed from the load they fall into the bottom of the tub, where two holes on the underside of the lower spray arm spray water on the tub bottom moving them to the filter. Larger items will fall through the larger openings in this filter and down into the sump. As the drain cycle begins this section of the sump is cleared first.



The third filter is a large wire mesh filter, this filter is around the outside of the center filter. It allows water to enter the outer section of the sump for the wash pump but not allow trapped food to leave the center section. This third filter is the only filter that could be installed wrong, there so it is marked showing which is the "TOP".



Mesh Filter

The customer is instructed to remove these filters periodically for cleaning. When removed the center section from the sump any food debris found in the bottom of the sump needs to be removed. This will help keep from stopping up the drain pump as well as reduce redeposit on future cycles.

Thermostats

Control Thermostat

The control thermostat is a normally open thermostat used when the option for a Hi – Temp wash is selected. The timer advances automatically through the wash cycle to a point at which the timer motor contact opens, stalling the timer. If the Hi – Temp option was selected the timer will not advance beyond this point until the water temperature in the tub raises to close the control thermostat. After the thermostat closes, the timer advances on to the next cycle. The time needed for this to occur can vary depending on incoming water temperature and load.

Safety Thermostat

The safety thermostat is a normally closed thermostat wired in series with the heater that will open if the temperature in the tub raises over 190°. This thermostat only disconnects power to the heater so the dishwasher will continue the cycle.

Control and Safety Thermostats in the Mount assembly

Both the control thermostat and the safety thermostat are mounted in one mount assembly and this assembly is locked to the side of the sump. In the mount, there are two small springs per thermostat pushing up to put pressure on the thermostat for better contact with the tub. Both thermostats will come as an assembly and need to be replaced as an assembly. When replacing the thermostats be sure to use Thermal Mastic on the new parts before installing them to the sump.

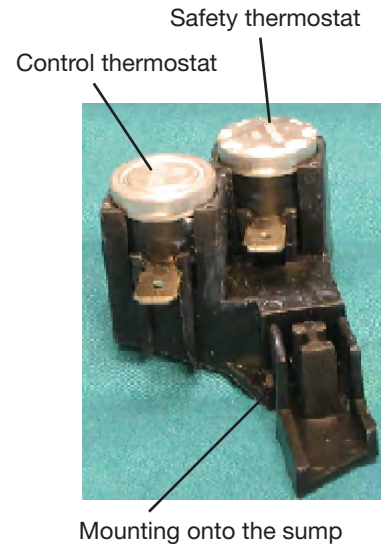

Heater

The purpose of the heater is to maintain and increase water temperature during the wash and rinse cycles and to assist in drying the dishes. The heater is a 525 watt element mounted in the right rear of the tub using a single mounting flange with a gasket molded to the under side. The tub has two heater supports welded to the bottom to support the heater on the left side.

Tub and Door Attachments

Air Gap

The air gap is needed for filling the dishwasher with clean water. There is a second purpose for the air gap, this is to allow outside air to enter the tub in the dry cycle. As steam rises in the tub and exits out the vent, cooler air enters through the air gap to create air movement in the tub which speeds drying. The air gap is mounted to the right outside of the tub.

Sump

The sump is a reservoir used by the wash pump to collect water before spraying it onto the dishes. The sump on this dishwasher has ports for the wash pump, the drain pump, the fill hose from the air gap and the pressure tube to the over flow pressure switch. The sump is mounted under the tub with a gasket to seal it to the tub and is locked in place with a locking ring from inside the tub. This locking ring turns counterclockwise to unlock the sump.

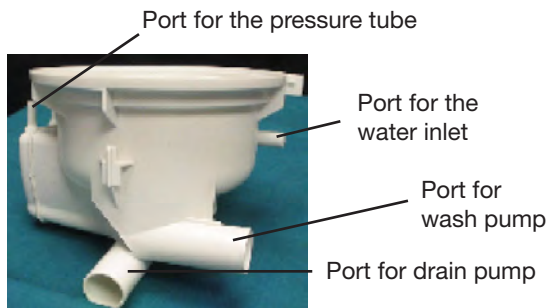
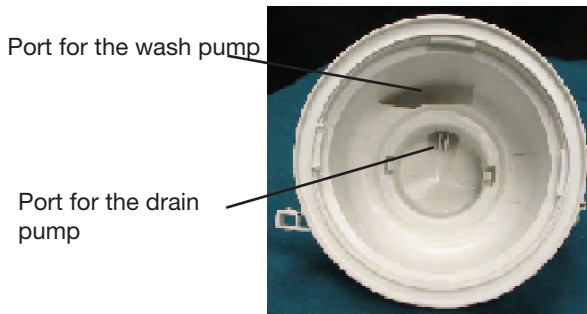

Delivery tube

The delivery tube supplies water to the center spray arm in the wash and rinse cycles. The delivery tube consists of two tubes; one from the wash pump up the outside back wall of the tub, the second mounted to the upper rack. The section from the wash pump is secured at the top by a locking nut on the inside of the tub. The tube has a gasket at the end on the outside of the tub to form a water seal. The second tube that is mounted to the upper rack snaps in place to the under side of the rack so it moves in and out with the rack. This tube has the center spray arm mounted to it.

Door hinge and Door Springs

The two door hinges are in one assembly. This assembly is attached to the frame by two hinge pins and locked in place with two lock washers. The inner door panel mounts to the hinge assembly with 2 screws on each side of the assembly. The door springs then mount vertically from the hinge arms to locator pins, one on each side of the tub. These pins pass through the side frame and allow for adjustment of the springs. If the door needs more tension, the locator pin is pulled out and raised to a higher hole location. If the tension is too great, it can be lowered. To make spring adjustments, the dishwasher will have to be pulled forward to access the pins.

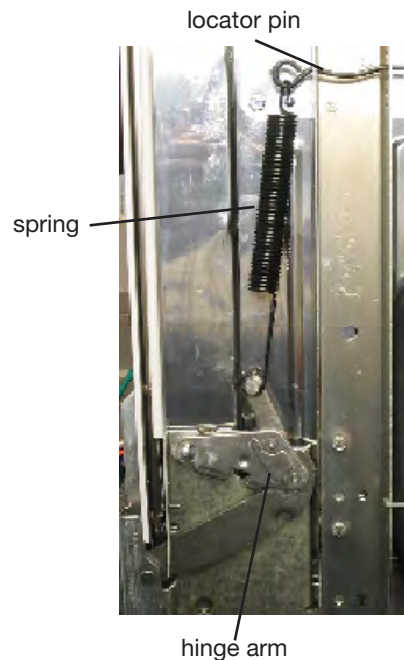

Door seal

The door seal seals the area between the tub and the inner door panel to prevent water leaks. The door seal around the tub is all one piece and presses into a channel formed around the inside of the tub. This seal is not glued to the tub but is just pressed into the channel. When installing this seal you will find there is an inside and an outside to the seal. You must start by checking the ends of the seal. There is a shaved edge, 6 inches up on both ends. This is the inside of the seal. Once the inside and outside have been determined, fold the gasket to find the center then press the seal in to the channel, starting at the top in front of the strike. Next go to the bottom. Have the bottom of the seal touch the tub bottom on both sides and press the seal in to the channel in one spot. From there go to the top corner and press the seal in at that location, repeating the same for the opposite side. Complete the installation by forming the gasket into the channel the rest of the way up both sides. Close the door to seat the seal. There is a bottom door seal mounted to the base of the inner door panel and this seal is non replaceable. If it comes loose or is pulled away from the panel, the inner door panel will need to be replaced.

Tub rollers

The rollers for the upper rack glides are on mounts with two rollers each. There are two sets on each side of the tub.

There are two screws per roller set and for added strength on the outside of the tub these screws pass through the frame of the unit. The roller sets each have o-rings on the inside of the tub for water seals. To replace the tub rollers the dishwasher will need to be removed from under the counter top.



Vent

The air vent for this dishwasher is located on the top left side of the inner door panel. A vent housing inside the console contains baffles to prevent water from splashing out of the tub during the wash and rinse cycles. In the dry cycle, steam laden air at the top of the tub passes out the vent. This allows outside air to enter the tub from the right hand side through the air gap. This air flow speeds the water evaporation, which in turn forces more steam and moisture out the vent. If the customer selects heated dry, the added heat increases the steam pressure and allows for faster drying of the load. There is a gasket around the vent housing and the vent housing and the vent grate are attached together with 4 mounting screws.

DISASSEMBLY AND SERVICE

Always turn off the power supply before servicing any electrical component, making ohm meter checks, or replacing any part.

All voltage checks should be made with a voltmeter having a full scale range of 130 volts or higher.

After service is completed, be sure all safety grounding circuits are completed, all electrical connections are secure and all access panels are in place.

Outer Door Panel

1. Outer door panel mounts onto inner door panel with six screws, three on each side
2. While holding outer door panel in place remove the bottom three screws from both sides of inner door panel.

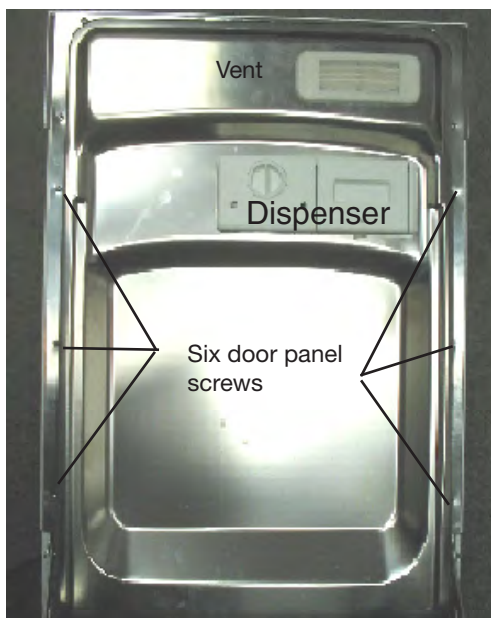

Console

1. Disconnect power to the dishwasher.
2. Remove outer door panel
3. Remove six screws holding console to the inner door panel. Leave the center two screws on either side of the door latch until last.

Timer

1. Disconnect power to the dishwasher
2. Remove outer door panel
3. Remove knob from timer by pulling straight off timer shaft
4. Remove console
5. Press in on locks for the disconnect block and pull block from timer.
6. Remove two timer mounting screws. Ground wire has a locking terminal press down on lock to remove terminal.

IMPORTANT NOTE

All terminals on this dishwasher are locking terminals and have a release that needs to be pressed down to remove wires from all electrical components.



Door Latch

1. Disconnect power to the dishwasher
2. Remove console from inner door panel
3. Remove two screws mounting door latch to console.
4. Remove four wires from latch. Terminals have locks, press down on lock to remove terminal.

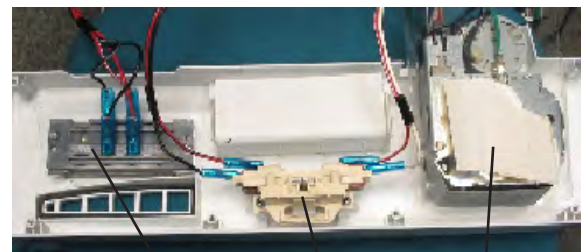

Selector Switch

1. Disconnect power to the dishwasher
2. Remove console from inner door panel
3. Remove two screws mounting selector switch from console
4. Remove four wires from selector switch. Terminals have locks press down on lock to remove terminal.

Vent Housing and Vent Grate

1. Disconnect power to the dishwasher.
2. Remove console from inner door panel.
3. Remove the four screws holding vent housing and vent grate located inside together.
4. On reassembly, make sure gasket is in place in vent housing.

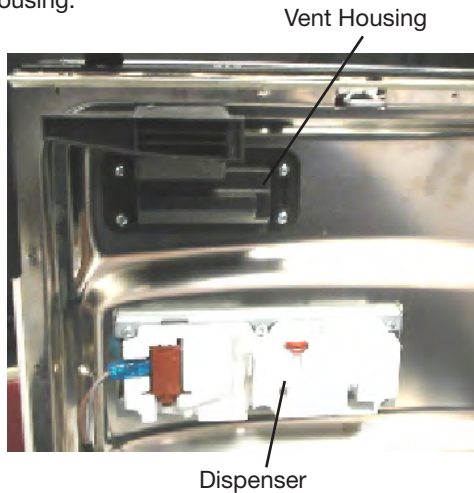

Dispenser

1. Disconnect power to the dishwasher.
2. Remove outer door panel.
3. Remove six screws holding dispenser into door panel. Remove mounting reinforcements from dispenser.
4. Remove two wires from dispenser wax motor. Terminals have locks press down on lock to remove terminal.

Lower Spray Arm

1. Turn the lock clockwise to release arm.
2. When reinstalling arm turn lock counter clockwise until lock clicks.



The lower spray arm has a lock holding it to the spray arm support

Upper Rack

1. Slide rack rail forward the end cap on the rail has a lock.
2. Push lock over and slide end cap off rail.
3. Slide rack from rails.



Center Spray Arm

1. Turn the lock clockwise looking down from top of rack to release arm.
2. When reinstalling arm turn lock counter clockwise looking down from top of rack until lock clicks. There is a gasket inside the spray arm and locking in place will be tight make sure spray arm is fully locked to delivery tube.



The center spray arm has a lock holding it to the delivery tube mounted under the upper rack

Door Seal

1. To remove the door seal, pull free from the channel around the tub.
2. Locate the inside of new seal. Go to the end of the seal one side will be shaved off. This is the inside.
3. Find center of seal. Push center of seal into channel at strike first to hold in place.
4. Go to bottom and adjust seal so end is on bottom of tub and push into channel.



5. Go to top corner and form seal into corner, then tack seal into channel down side.
6. Repeat for opposite side.
7. Close door to seat seal into channel.

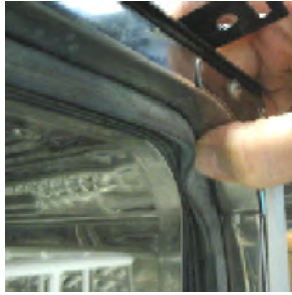

Water Valve

1. Disconnect power to dishwasher.
2. Remove toe kick and outer door panel.
3. Turn off water supply to dishwasher then place protection under water line that attaches to the water valve to catch water that will be in the line.
4. Two screws hold valve to frame.
5. Disconnect wires from valve. Terminals have locks press down on lock to remove terminal.
6. Remove fill hose from valve.
7. Install in reverse order.

Mounting screws

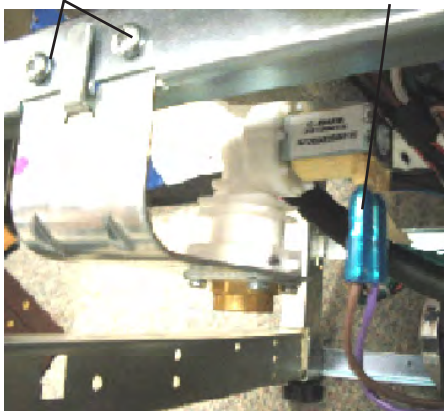

Power connections

1. Disconnect power to dishwasher.
2. Remove as much water as possible from sump.
3. Remove toe kick and outer door panel.
4. Turn off water supply to dishwasher, then place protection under water line that attaches to the water valve to catch water that will be in the line as supply line is removed from the water valve.
5. Access repair per note above or remove unit from under counter top.
6. If unit was removed, lay units on it back. Make sure there is protection for the floor before unit is laid down.
7. Disconnect disconnect block to remove thermostats.

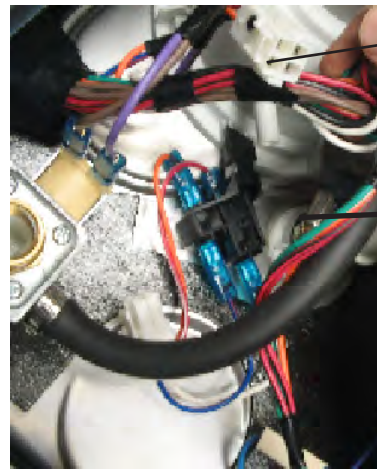

Disconnect block for thermostats

Thermostats mounted to the sump

8. Remove thermostats and mount from sump.
9. Remove the four wires from the thermostats. To remove terminals with locks, press down on lock.
10. Apply Thermal mastic to head of new thermostats before installing onto sump.
11. Reconnect wires to thermostats.
12. Install thermostat and mount assembly onto sump.
13. Complete repairs in reverse order.

Thermostats and Mounting Bracket

New thermostats will come with a new mount.

NOTE

It maybe possible to replace the thermostats with the dishwasher installed under the counter by removing the front top frame rail. Access to the thermostats can be gained by first removing the top rail that mounts between the left and right front frames. To remove this rail first turn off the water to the unit and disconnect power then remove the water valve along with the junction box then the two mounting screws securing on each side of the rail securing it to the frames. See front frame and rail configuration on next page.

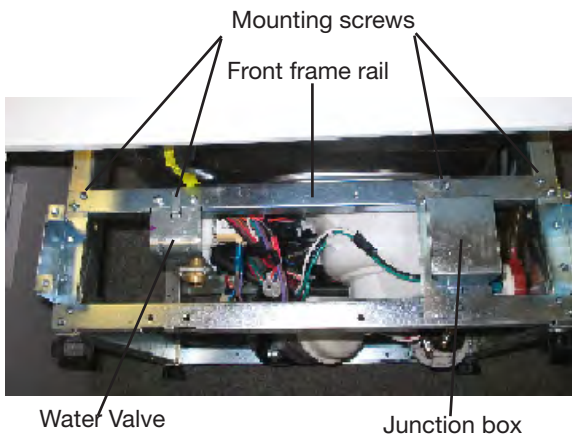

Pressure Switch

1. Disconnect power to dishwasher.
2. Remove as much water as possible from sump.
3. Remove toe kick and outer door panel.
4. Remove unit from under counter top far enough to access back of pressure switch.
5. Removing junction box could give you access to the pressure switch.

CAUTION

The following repairs will require pulling the dishwasher either part way or all the way from under the counter top. When removing the product from under the counter, extreme care must be taken to protect the product and the floor from damage. Always use protection under the feet and legs when pulling unit out. When reinstalling make sure product is leveled and secured.

Door Spring

1. Loosen dishwasher and pull forward to access door spring.
2. Pull pin out of side frame to release top of spring.
3. Replace spring adjust as needed by installing pin into proper hole in frame. Apply grease on both ends of the spring after making final adjustment.
4. Reinstall making sure unit is level and secure.

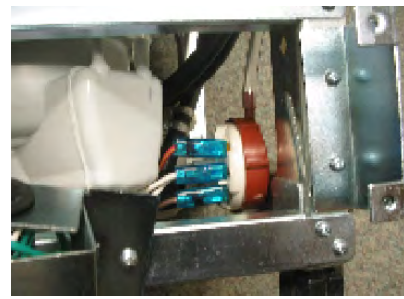
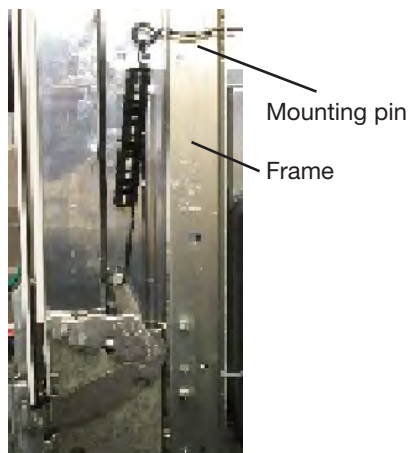

6. With pliers, compress mount on back side of switch and pull switch from frame. See figure below
7. Disconnect the three wires from the pressure switch. Terminals have locks, press down on lock to remove terminal.
8. Remove pressure hose from switch by pushing it from the switch.
9. Complete repair in reverse order.



Hinge Assembly

1. Disconnect power to dishwasher.
2. Loosen dishwasher and pull forward to access door spring.
3. Pull pin out of side frame to release top of spring.
4. Remove outer door panel.
5. Remove screws and nuts holding inner door panel to hinges, close and latch inner door panel.
6. Remove locking clip from both hinge pins and slide hinge assemble from product.

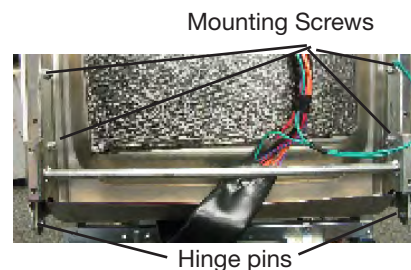

7. Reassemble in reverse order making sure lubricant is used on both ends of springs.
8. Adjust springs as needed before installing under counter.
9. Reinstall making sure unit is level and secure.

Figure below shows all components of the dishwasher with the unit laying on it's back

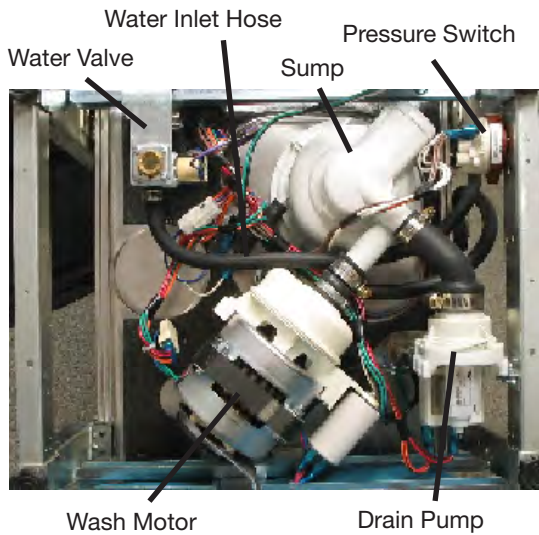

Drain Pump

1. Disconnect power to dishwasher.
2. Remove as much water as possible from sump before starting this repair.
3. Remove toe kick and outer door panel.
4. Turn off water supply to dishwasher then place protection under water line that attaches to the water valve to catch water that will be in the line as supply line is removed from the water valve.
5. Remove unit from under counter top. See Caution on page 10.
6. Place protection under pump to catch water as drain hose is removed from pump.
7. Remove the two screws mounting pump to side frame of unit .
8. Disconnect wires from the drain pump. Terminals have locks, press down on lock to remove terminal.
9. Replace drain pump in reverse order.

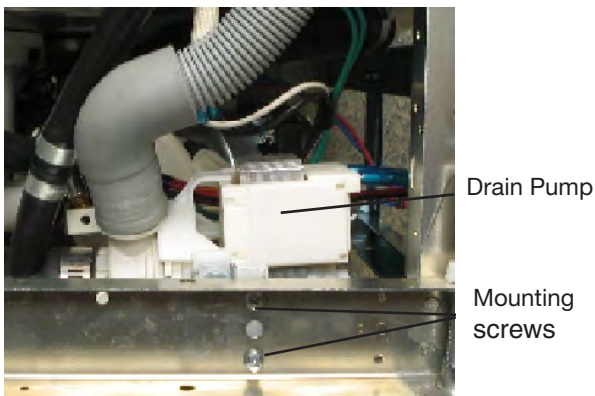

Wash motor and pump Assembly

1. Disconnect power to dishwasher.
2. Remove as much water as possible from sump before starting this repair.
3. Remove toe kick and outer door panel.
4. Turn off water supply to dishwasher, then place protection under water line that attaches to the water valve to catch water that will be in the line as supply line is removed from the water valve.
5. Remove unit from under counter top. See Caution on page 10.
6. The front of the pump is held in placed by the hose to the lower spray arm support, delivery tube, and the intake hose. The rear has an adjustable mounting bracket.
7. Remove the two screws from the rear frame holding motor mounting bracket before laying dishwasher on it, back. Make sure there is protection for the floor before unit is laid down.

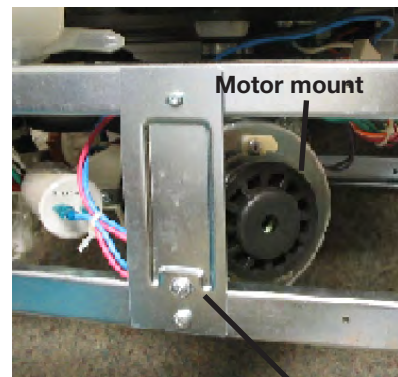

8. Disconnect the two wires from disconnect block and the ground wire attached to the motor frame. Terminals have locks, press down on lock to remove terminal.
9. Remove hose clamps from delivery tube, lower spray arm support, and inlet hose to remove motor and pump assembly.
10. Remove pump and motor assembly.
11. Complete repair in reverse order.

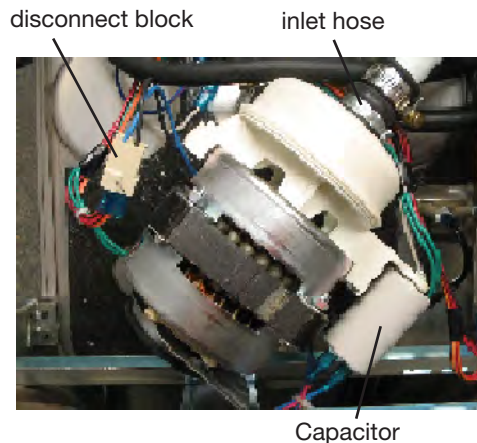

Heater

1. Disconnect power to dishwasher.
2. Remove as much water as possible from sump before starting this repair.
3. Loosen heater from mounts holding heater on the left side of tub.



4. Remove toe kick and outer door panel.
5. Turn off water supply to dishwasher then place protection under water line that attaches to the water valve to catch water that will be in the line as supply line is removed from the water valve.
6. Remove unit from under counter top. See Caution on page 10.
7. Lay unit on it's back. Make sure there is protection for the floor before unit is laid down.
8. Disconnect wires from the heater. Terminals have locks, press down on lock to remove terminal.

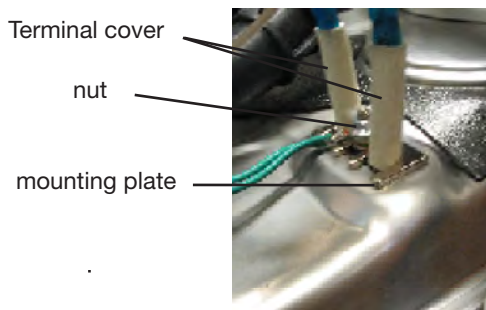

9. Remove nut holding ground wire to mounting screws then remove mounting nut and mounting plate. Push heater into tub.
10. Place new element into tub and fasten heater into mounts and lock in place insert terminals through tub.
11. Install mounting plate and nut, tighten nut.
12. Install ground wire and nut and tighten.

Sump

1. Disconnect power and turn off the water supply to the dishwasher before starting this repair.
2. Remove as much water as possible from sump.
3. Remove lock from inside sump by turning counter clockwise. A pair of slip jaw pliers may be used. Place into sump as shown to turn lockout of sump.



4. Remove toe kick and outer door panel.
5. Before removing the incoming water line to the dishwasher place protection under the water valve to catch any water that will be in the line as it is removed.
6. Remove unit from under counter top. See Caution on page 10.
7. Lay unit on it's back. Make sure there is protection for the floor before unit is laid down.
8. Remove hoses from sump. The hose from the pressure switch, which is mounted to the air chamber of the sump, **is removed easier if it is pushed from the sump and not pulled off by the hose.**
9. Disconnect the disconnect for the thermostats.
10. Carefully remove thermostat mount from sump.
11. Install thermostats on new sump. Make sure there is Thermal mastic on thermostat before mounting sump. Install sump gasket into top of sump.
12. Place sump into tub. There is a square locator in sump, this is to help position the sump properly before locking it in place. Now reinstall all of the hoses.
13. Make sure all clamps are tight then check the sump lock to be sure it is tight.
14. Continue to complete repair in reverse order.

PARTS LIST BREAKDOWN

DOOR / CONTROL PANEL

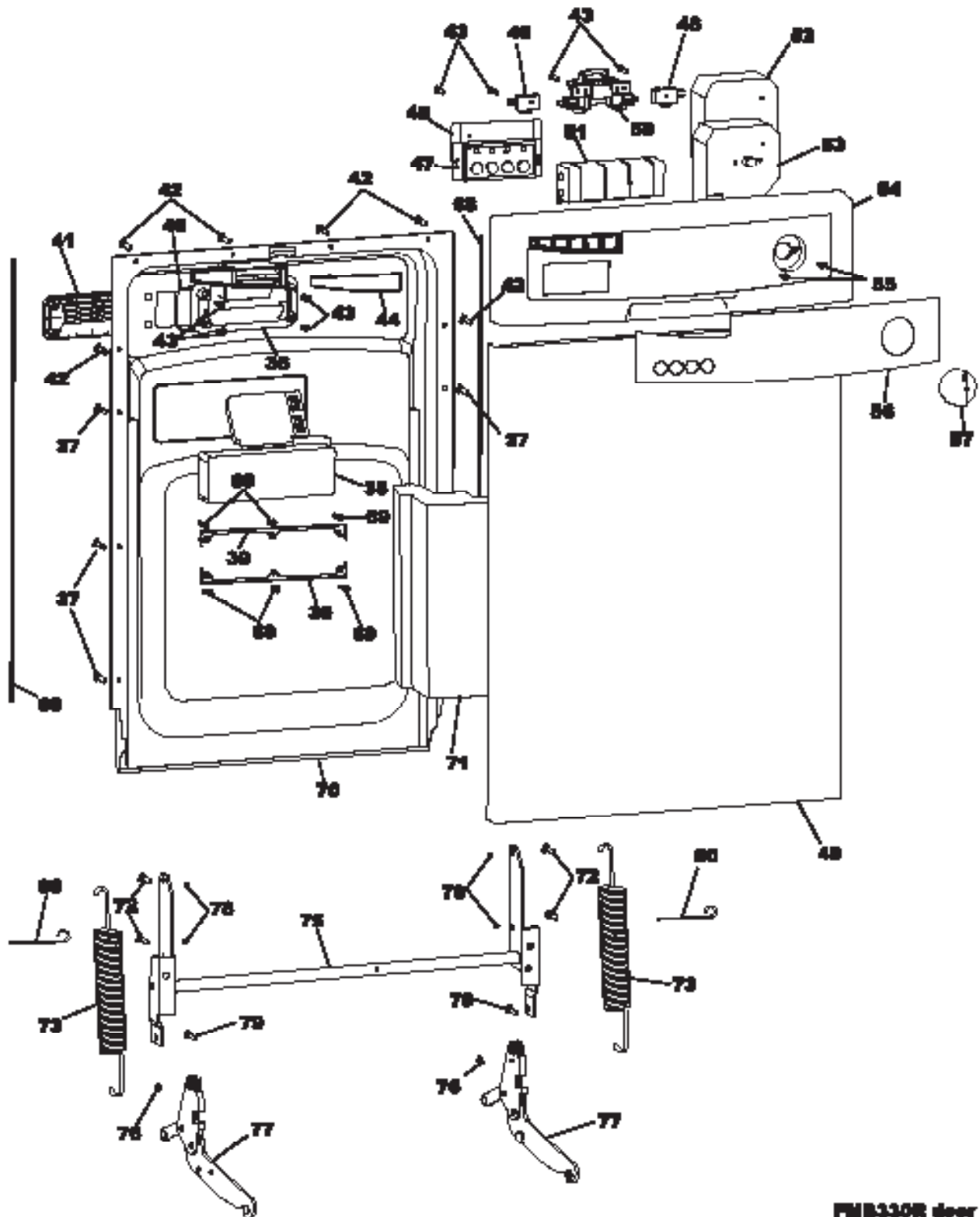

FMB330R door

DOOR / CONTROL PANEL

POS. NO	PART N°	A FMB338RG (FMB338RG50)			DESCRIPTION
		B FMB338RG (FMB338RG50)			
		C FMB338RG (FMB338RG50)			
36	5904458829	A	B	C	Vest Assembly, door
37	5904458810	A	B	C	Screw, tapping, s3.5 x 13, (6)
38 #	5904458811	A	B	C	Dispenser Assembly
39	5904458812	A	B	C	Bracket, dispenser, (2)
40	5904458813	A	B	C	Gasket, door vest, inner door
41	5904458814	A	B	C	Cover, door vest
42	5904458815	A	B	C	Screw, tapping, s3.5 x 14, (6)
43	5904458816	A	B	C	Screw, pan hd, tapping, s4 x 12, (6)
44	5904458817	A	B	C	Gasket, door vest, outer door
45	5904458818	A	B	C	Guard, tap switch, film
47 #	5904458819	A	B	C	Switch, 4 button, tap
48 #	5904458820	A	B	C	Switch, door lock, (2)
49	5904451714	A	-	-	Door Panel, outer, white
49	5904451715	-	B	-	Door Panel, outer, black
49	5904451713	-	-	C	Door Panel, outer, stainless
50 #	5904458823	A	B	C	Latch, door
51	5904458825	A	-	-	Cover, handle, white
51	5904458824	-	B	C	Cover, handle, black
52	5904458826	A	B	C	Guard, timer, film
53 #	5904458827	A	B	C	Timer Assembly
54	5904451532	A	-	-	Panel, console, white
54	5904458829	-	B	C	Panel, console, black
55	5904458830	A	B	C	Screw, hex hd, tapping, s5 x 12, (6)
56	5904458831	A	-	-	Overlay, console, white
56	5904458828	-	B	C	Overlay, console, black
57	5904458835	A	-	-	Knob, inner, white
57	5904458834	-	B	C	Knob, inner, black
68	5904458837	A	-	-	Guard, door edge, white, (2)
68	5904458836	-	B	C	Guard, door edge, black, (2)
69	5904458838	A	B	C	Screw, tapping, m3.5 x 12, (6)
70	5904458839	A	B	C	Liner, door, inner
71	5904458840	A	B	C	Insulation, door, polystyrene
72	5904458841	A	B	C	Screw, M5 x 10, (4)
73	5904458842	A	B	C	Spring, door, (2)
75	5904458843	A	B	C	Hinge Assembly, door
76	5904458844	A	B	C	Clamp, hinge pin, (2)
77	5904458845	A	B	C	Hinge, arm, (2)
78	5904458846	A	B	C	Nut, lock, M5, (4)
79	5904458847	A	B	C	Pin, hinge, (2)
80	5904458848	A	B	C	Ball, door spring, (2)
+	5904451803	A	B	C	Energy Guide

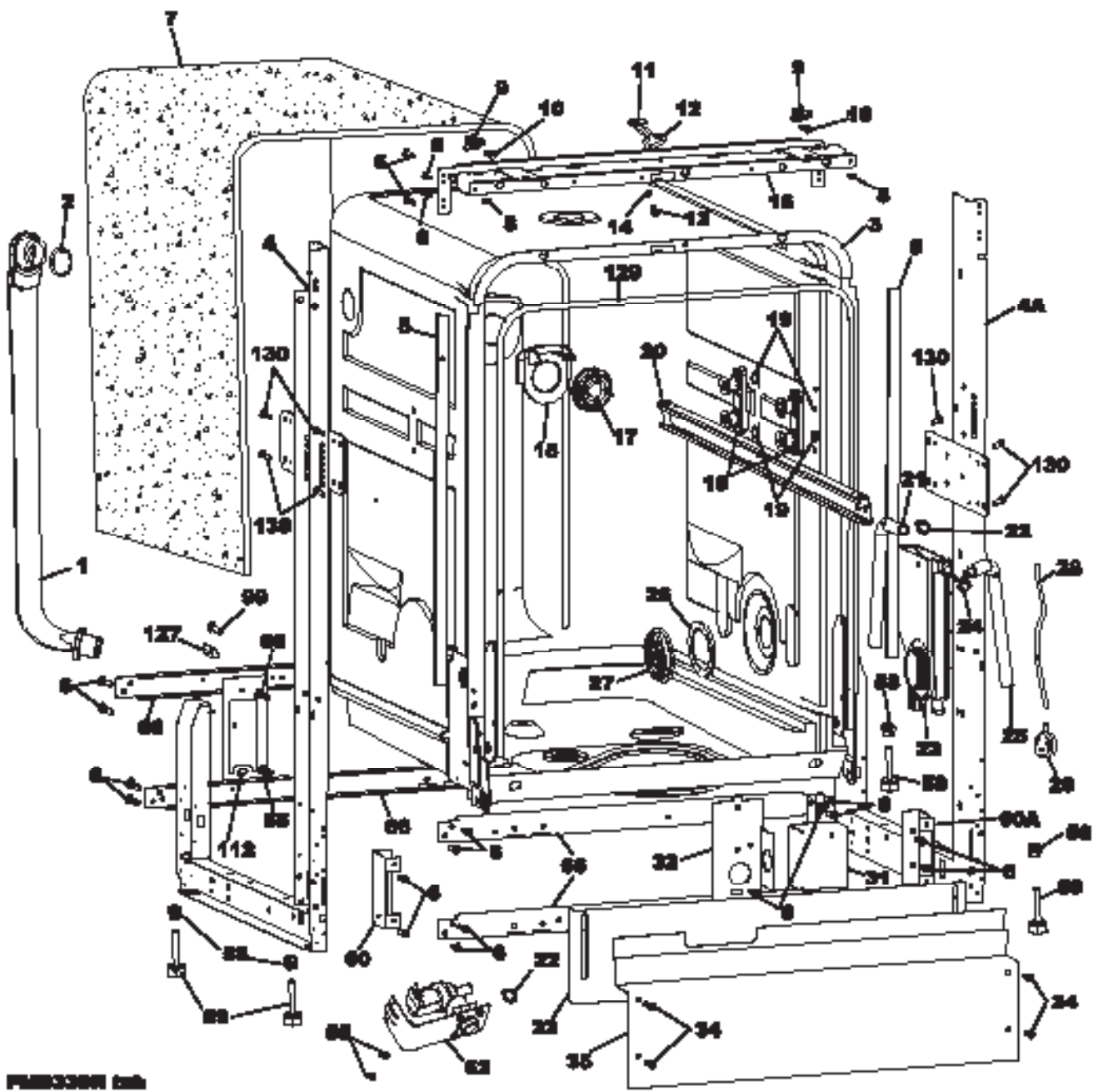
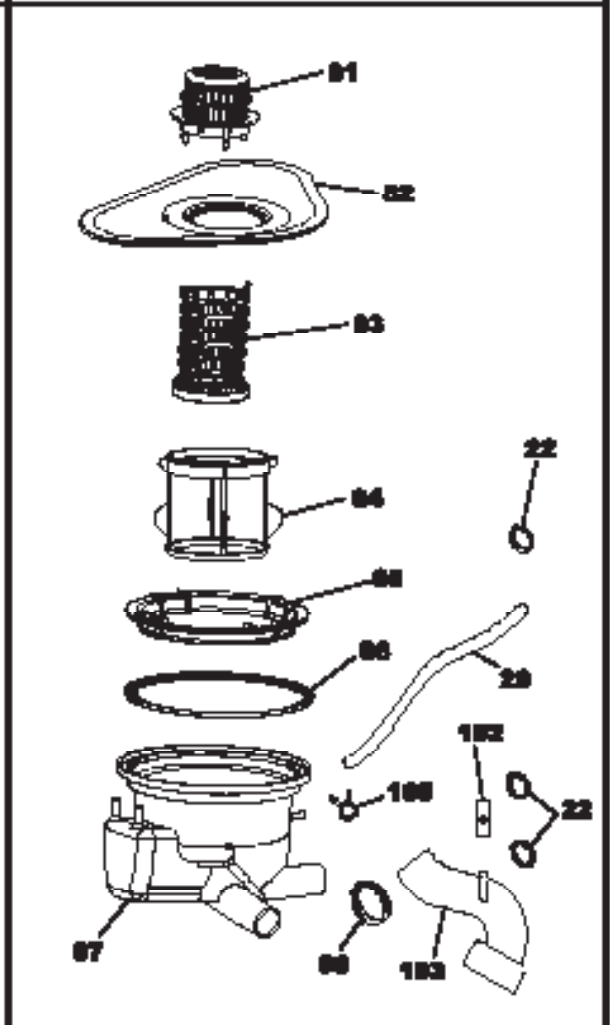
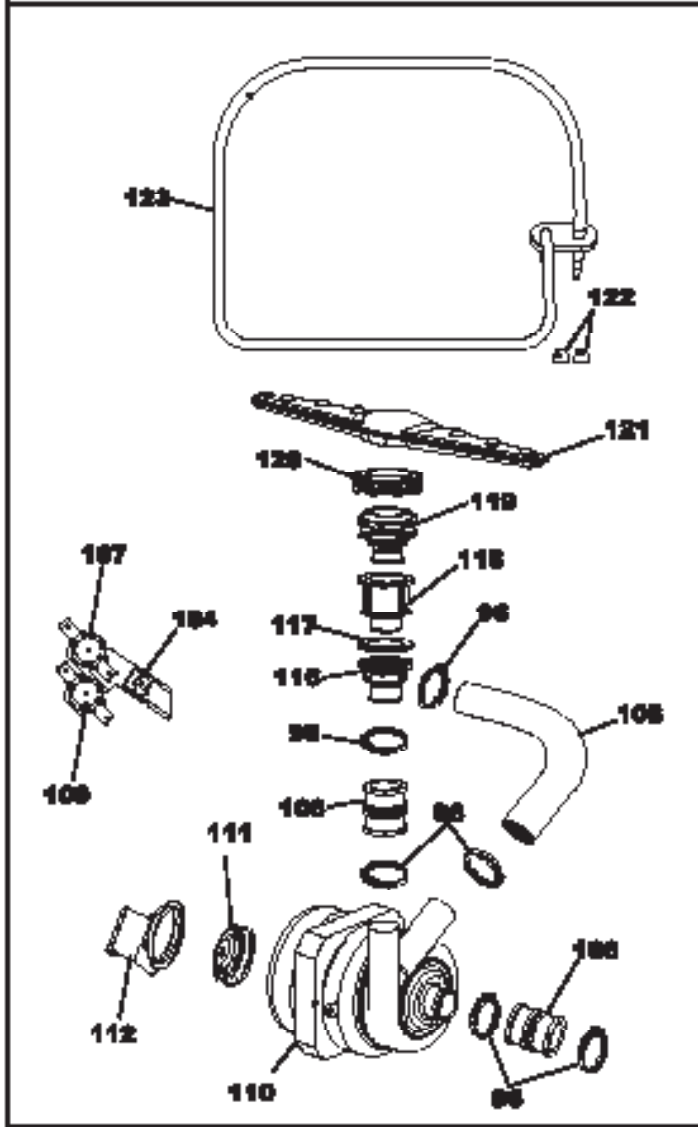
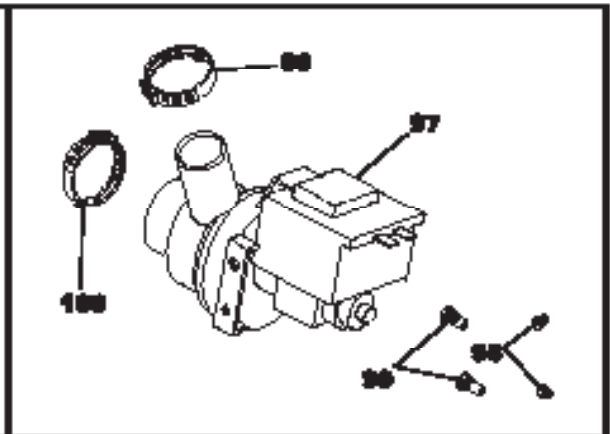
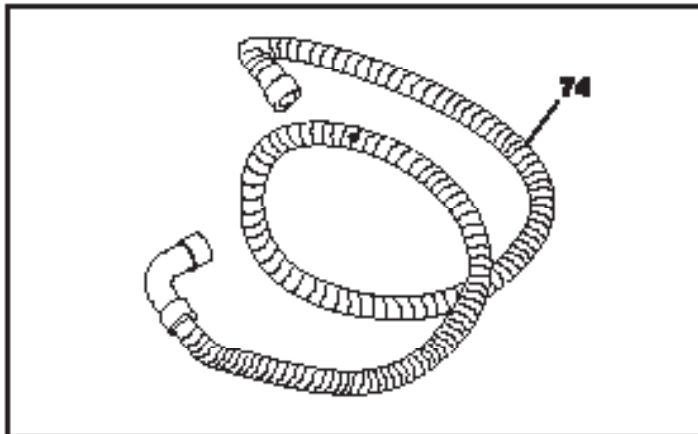

FIGURE 10 (cont)

TUB

Model Index:	A FM5308RG (FM5308RGS0)			B FM5308RG (FM5308RGS0)			C FM5308RG (FM5308RGC0)		
PCBL NO	PART NBR	A	B	C	DESCRIPTION				
1	5904458949	A	B	C	Hose, delivery, external				
2	5904458950	A	B	C	O-ring, delivery hose				
3	5904458951	A	B	C	Tub Assembly				
4	5904458952	A	B	C	Frame, tub, LH				
4A	5904458953	A	B	C	Frame, tub, RH				
5	5904451716	A	-	-	Guard, tub gasket, white, (2)				
5	5904458954	-	B	C	Guard, tub gasket, black, (2)				
6	5904458955	A	B	C	Screw, tapping, s3.5 x 9, (26)				
7	5904458956	A	B	C	Isolator, tub wrapper, outer				
8	5904458957	A	B	C	Rivet, (6)				
9	5904458958	A	B	C	Block, tub, (2)				
10	5904458959	A	B	C	Screw, tapping, s3.5 x 11, (2)				
11	5904458960	A	B	C	Bracket, door lock mtg				
12	5904458961	A	B	C	Hook, door lock				
13	5904458962	A	B	C	Screw, hook mtg, m4 x 16				
14	5904458963	A	B	C	Nut, hook mtg, M4, lock				
15	5904458964	A	B	C	Housing, delivery hose, inner				
16	5904451717	A	B	C	Crosspiece, front, upper				
17	5904458965	A	B	C	Nut, delivery hose, inner				
18	5904458966	A	B	C	Roller Assembly, tub, (4)				
19	5904458967	A	B	C	O-ring, tub roller, (8)				
20	5904458968	A	B	C	Rail, guide, upper sock, (2)				
21	5904458969	A	B	C	Hose, drain pump				
22	5904458970	A	B	C	Clamp, hose, OTR175, (5)				
23	5904458971	A	B	C	Turner, water				
24	5904458972	A	B	C	Clamp, hose, 14.9 x 1.8				
25	5904458973	A	B	C	Hose, inlet, water tunnel				
26	5904458974	A	B	C	Gasket, ring rail				
27	5904458975	A	B	C	Nut, ring				
28	5904458976	A	B	C	Tubing, pressure switch				
29 #	5904458977	A	B	C	Switch, pressure				
31	5904458978	A	B	C	Box, junction, RH				
32	5904458979	A	B	C	Box, junction				
33	5904451718	A	-	-	Toe Grille, adjustable, white				
33	5904451719	-	B	C	Toe Grille, adjustable, black				
34	5904451720	A	B	C	Screw, pan hd, tapping, s3.9 x 13, (4)				
35	5904451722	A	-	-	Kickplate, white				
35	5904451721	-	B	C	Kickplate, black				
55	5904458980	A	B	C	Screw, hex hd, tapping, s5 x 12, (6)				
58	5904458980	A	B	C	Nut, leveling leg, (4)				
58	5904458981	A	B	C	Leg, leveling, (4)				
60	5904451723	A	B	C	Bracket, kickplate mtg, LH				
60A	5904451724	A	B	C	Bracket, kickplate mtg, RH				
63 #	5904458982	A	B	C	Valve, water inlet				
66	5904458983	A	B	C	Crosspiece, lower, (4)				
99	5904458984	A	B	C	Screw, m6 x 12, (3)				
112	5904458985	A	B	C	Bracket, motor support				
127	5904458986	A	B	C	Block, tub gasket, (2)				
129	5904458987	A	B	C	Gasket, tub				
130	5904458988	A	B	C	Screw, hex hd, tapping, s5 x 28, (8)				

MOTOR & PUMP



FWD330R motor

MOTOR & PUMP

Model Index:		A FM5300RG (FM5300RGS0)		B FM5300RG (FM5300RGS0)		C FM5300RG (FM5300RGS0)	
PCBL NO	PART NDL						
22	5904460970	A	B	C	Clamp, hose, OTR175, (5)		
28	5904460976	A	B	C	Tubing, pressure switch		
74	5904460989	A	B	C	Hose, drain		
81	5904460990	A	B	C	Filter, upper		
82	5904460991	A	B	C	Filter, screen, stainless		
83	5904460992	A	B	C	Filter, lower		
84	5904460993	A	B	C	Filter, micro screen		
85	5904460994	A	B	C	Nut, sump mtg		
86	5904460995	A	B	C	Gasket, sump		
87	5904460996	A	B	C	Sump		
96	5904460997	A	B	C	Clamp, hose, OTR210, (8)		
97 #	5904461725	A	B	C	Pump, drain		
98	5904460998	A	B	C	Nut, MA, (2)		
99	5904460994	A	B	C	Screw, m6 x 12, (8)		
100	5904460999	A	B	C	Clamp, hose, OTR440		
102	5904461000	A	B	C	Hose, pump, inlet		
103	5904461001	A	B	C	Hose, duct to pump		
104	5904461726	A	B	C	Bracket, thermostat		
105	5904461002	A	B	C	Clamp, hose, 12.5 x 1.8		
106	5904461003	A	B	C	Duct, connecting, (2)		
107#	5904461727	A	B	C	Thermostat, 50		
108	5904461004	A	B	C	Duct, connecting, delivery hose		
109#	5904461728	A	B	C	Thermostat, 90		
110#	5904461005	A	B	C	Motor, pump assembly		
111	5904461006	A	B	C	Pad, motor vibration		
112	5904460995	A	B	C	Bracket, motor support		
116	5904461007	A	B	C	Support, manifold, lower		
117	5904461008	A	B	C	O-ring, 58 x 2.4		
118	5904461009	A	B	C	Tie-in, inner		
119	5904461010	A	B	C	Axis, sprayarm, lower		
120	5904461011	A	B	C	Nut, sprayarm, lower		
121	5904461012	A	B	C	Sprayarm Assembly, lower		
122	5904461013	A	B	C	Bracket, element, (2)		
123#	5904461014	A	B	C	Element Assembly, heating		
* #	5904461015	A	B	C	Harness, wiring, main		

RACKS

Model Index:		A FMB330RG (FMB330RGS0)
		B FMB330RG (FMB330RGS0)
		C FMB330RG (FMB330RGS0)
PCS. NO	PART NO.	DESCRIPTION
88	5904461816	A B C Rack Assembly, upper
89	5904461817	A B C Dispenser, loading, upper
90	5904461818	A B C Pipe, sprayarm, upper
91	5904461819	A B C Ring Nut, sprayarm, upper
92	5904461820	A B C Sprayarm, upper
93	5904461821	A B C Block, sprayarm, upper
94	5904461822	A B C Rack Assembly, lower
95	5904461823	A B C Basket, silverware

Service Information

IMPORTANT SAFETY NOTICE

THIS INFORMATION IS INTENDED FOR USE BY INDIVIDUALS POSSESSING ADEQUATE BACKGROUNDS OF ELECTRICAL, ELECTRONIC AND MECHANICAL EXPERIENCE. ANY ATTEMPT TO REPAIR A MAJOR APPLIANCE MAY RESULT IN PERSONAL INJURY AND PROPERTY DAMAGE. THE MANUFACTURER OR SELLER CANNOT BE RESPONSIBLE FOR THE INTERPRETATION OF THIS INFORMATION, NOR CAN IT ASSUME ANY LIABILITY IN CONNECTION WITH ITS USE.

DISCONNECT POWER BEFORE SERVICING

IMPORTANT - RECONNECT ALL GROUNDING DEVICES IF GROUNDING WIRES, SCREWS, STRAPS, CLIPS, NUTS OR WASHERS USED TO COMPLETE A PATH TO GROUND ARE REMOVED FOR SERVICE, THEY MUST BE RETURNED TO THEIR ORIGINAL POSITION AND PROPERLY FASTENED.



WARNING Certain internal parts are intentionally not grounded and may present a risk of electric shock only during servicing. Service personnel – **DO NOT** contact the following parts while the appliance is energized: *heating element, water valve, capacitor and drain pump and active vent motor (if present).*

SPECIFICATIONS

Electrical Supply (Under Load) - 60 Hz - 120VAC±10%

Supply Water Flow Rate - Must fill 0.85 gallons container in 75 seconds.

Supply Water Temperature - 120°F to 150°F (49°C - 66°C)

Before starting dishwasher, run water at sink faucet until hot.

Water Charge - 0.85 gallons (3.2 liters)

Spray Arm Rotation - 20 to 60 RPM

COMMON CAUSES OF LEAKS

Door area

- Tub gasket not firmly seated in corners.
- Tub shifted out of square during installation, causing leak in upper corners.
- Spray arm split, open crimp seams, or binding.
- Sudsing, which may be caused by:
 - use of non-dishwasher detergent.
 - low water temperature.
 - inferior dishwasher detergent, not suppressing foam.

Lower pump housing and motor area

- Motor shaft seal damaged or defective.
- Pump housing cracked.
- Hose connections loose.

Other areas

- Water temperature over 160°F (71°C) causing excessive condensation.

WASHABILITY COMPLAINTS

Dishes not clean

- Supply water temperature 120°F (50°C) for best results
- Improper loading
- Detergent is old, caked or lumpy
- Detergent cup is not releasing or opening too soon
- Low water charge due to low water pressure or clogged water valve
- Hard water film (water with 12 grains or more hardness may require a water softener), use more detergent
- Etching (usually on glassware), caused by a combination of soft water (0-4 grains), water temperature over 160°F (71°C), or too much detergent

Dishes not dry

- Dishes not loaded to permit proper draining
- Wetting agent not being used in models equipped with automatic wetting agent dispenser
- Supply water temperature under 120°F (50°C). Purge cold water out of hot water faucet
- Low voltage supply
- Failed heating element—a good element has a resistance of 21.4 to 30.8 ohms

Staining

- Coffee/Tea
 - To remove:
 - Place items in dishwasher and add 1 tablespoon of chlorine bleach to the detergent. Run machine through the cycle. **DO NOT LOAD SILVERWARE OR METAL ITEMS.**
- Red or brown stains (iron stains) on the tub or dishes may be caused by as little as 1PPM of iron in the water supply.
 - To remove:
 - Remove **all** dishware and silverware.
 - Place detergent in covered cup.
 - Allow dishwasher to run through complete normal cycle uninterrupted. The dry cycle may be omitted.
- Hard Water Film/Film/Lime Deposit Build-Up
 - To remove:
 - Pour 2 cups of vinegar into empty dishwasher and run through Rinse/Hold Cycle. Filmed glasses /dishware may also be cleaned in this manner, but not silverware.

Note: Some commercial products, such as “Lime-A-Way”, may be available in your area. **Carefully follow instructions on product container.**

TIMER SWITCHING FUNCTIONS IN MINUTES

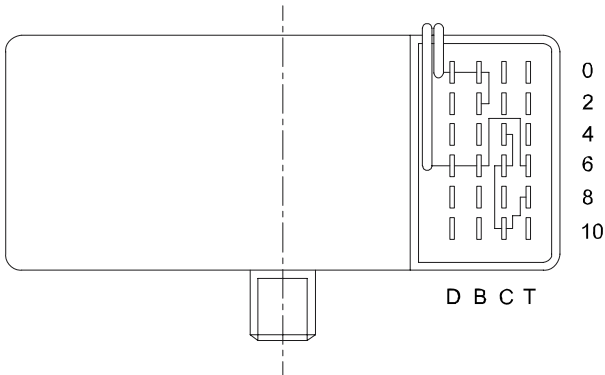
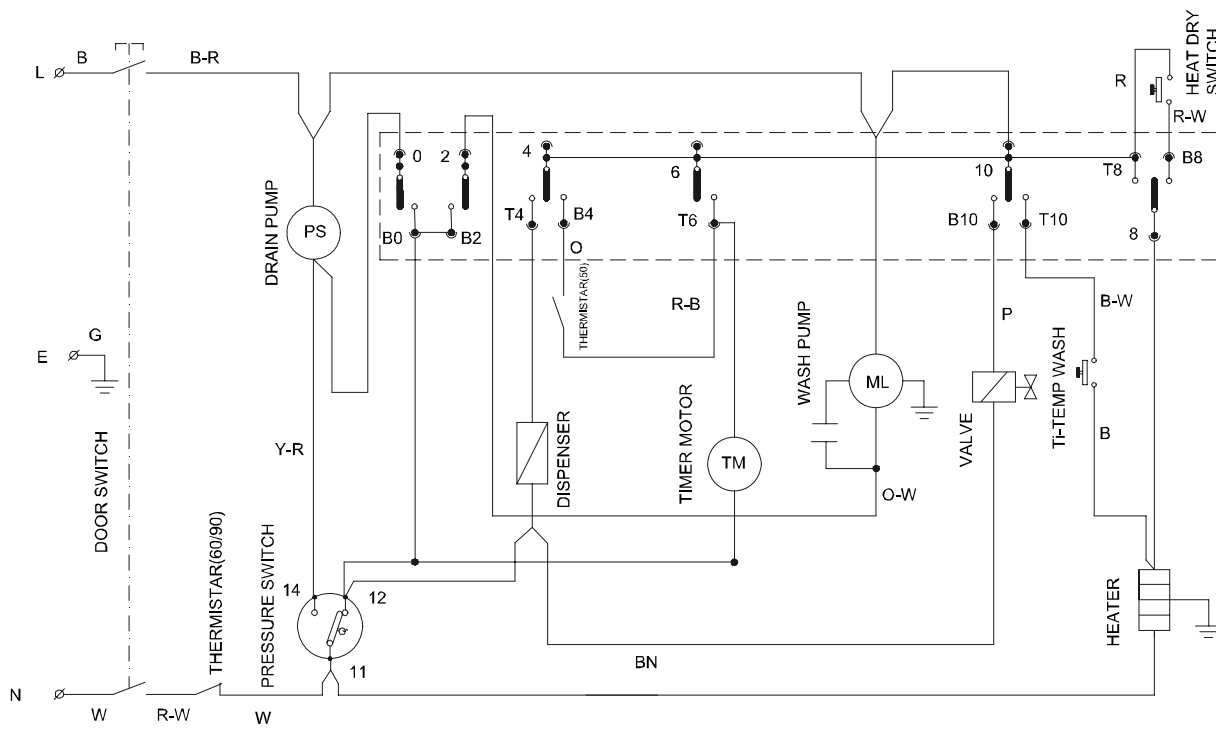
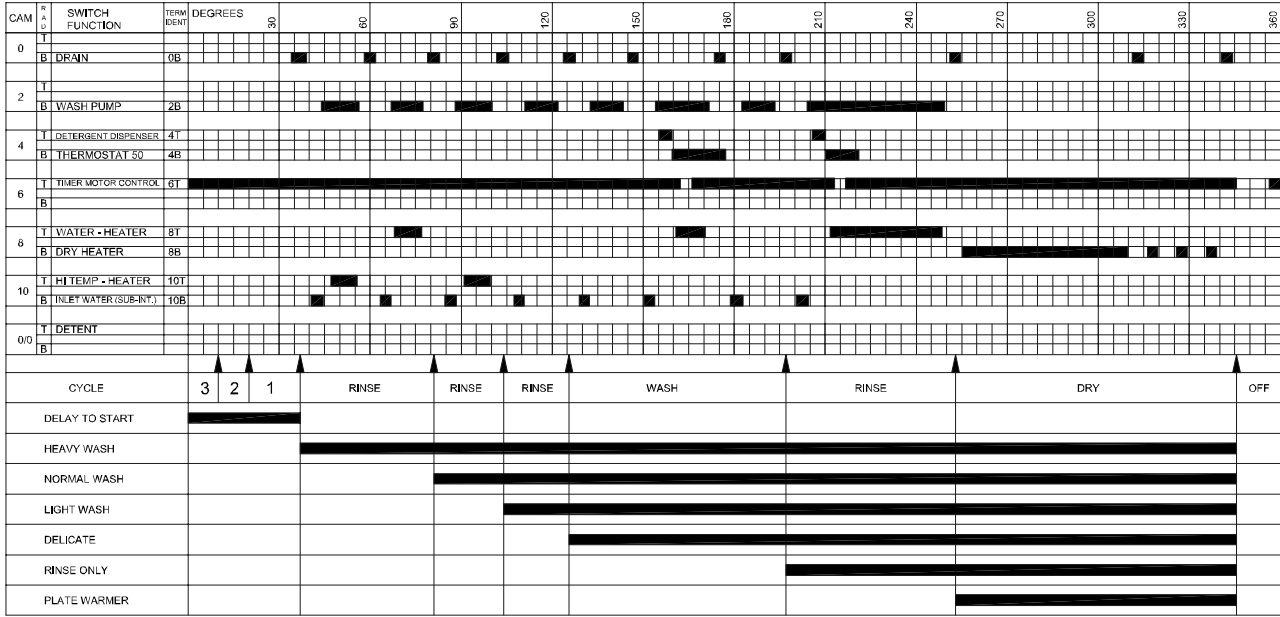

COLOR CODE	
R: RED	B-W: BLACK & WHITER
O: ORANGE	O-W: ORANGE & WHITER
G: GREEN	R-W: RED & WHITER
W: WHITER	B-R: BLACK & RED
B: BLACK	Y-R: YELLOW & RED
P: PURPLE	R-B: RED & BLUE
BN: BROWN	

 **Electrolux**

