



ELECTROLUX HOME PRODUCTS NORTH AMERICA

SERVICE MANUAL

FROST-FREE

CHEST FREEZER

Frigidaire

TAPPAN

W White-Westinghouse

Gibson

Kelvinator 

SAFE SERVICING PRACTICES - ALL APPLIANCES

To avoid personal injury and/or property damage, it is important that **Safe Servicing Practices** be observed. The following are some limited examples of safe practices:

1. **DO NOT** attempt a product repair if you have any doubts as to your ability to complete it in a safe and satisfactory manner.
2. Before servicing or moving an appliance:
 - Remove the power cord from the electrical outlet, trip the circuit breaker to the OFF position, or remove the fuse.
 - Turn off the gas supply.
 - Turn off the water supply.
3. Never interfere with the proper operation of any safety device.
4. **USE ONLY REPLACEMENT PARTS CATALOGED FOR THIS APPLIANCE. SUBSTITUTIONS MAY DEFEAT COMPLIANCE WITH SAFETY STANDARDS SET FOR HOME APPLIANCES.**
5. **GROUNDING:** The standard color coding for safety ground wires is **GREEN**, or **GREEN** with **YELLOW STRIPES**. Ground leads are not to be used as current carrying conductors. It is **EXTREMELY** important that the service technician reestablish all safety grounds prior to completion of service. Failure to do so will create a hazard.
6. Prior to returning the product to service, ensure that:
 - All electrical connections are correct and secure
 - All electrical leads are properly dressed and secured away from sharp edges, high-temperature components, and moving parts
 - All non-insulated electrical terminals, connectors, heaters, etc. are adequately spaced away from all metal parts and panels
 - All safety grounds (both internal and external) are correctly and securely connected
 - All panels are properly and securely reassembled

ATTENTION!!!

This service manual is intended for use by persons having electrical and mechanical training and a level of knowledge of these subjects generally considered acceptable in the appliance repair trade. Electrolux Home Products cannot be responsible, nor assume any liability, for injury or damage of any kind arising from the use of this manual.

SAFE SERVICING PRACTICES	2
QUICK REFERENCE SHEET	6
Serial nameplate location	6
Serial number breakdown	6
Tech sheet location	6
Refrigerant charge	7
Electrical specifications	7
Temperature control	7
Defrost control	7
Performance	7
System schematic	7
Sample wiring diagram	8
SECTION A - OWNERS GUIDE	9
Product registration	9
Energy saving ideas	9
Important safety instructions	9
Proper disposal of your refrigerator/freezer	9
Grounded wall receptacle	9
For your safety	10
Child safety	10
Electrical information	10
Other precautions	10
First steps	10
Installation	10
Leveling	10
To level chest unit	11
Cleaning	11
Lid removal	11
Setting the temperature control	11
Cool down period	11
Temperature control	11
Freezer optional features	11
Power on light	11
Security lock with pop-out key	11
Interior light	11
Slide-aside basket	11
Care and cleaning	12
Cleaning the inside	12
Wire shelf removal	12
Cleaning the outside	12
Power failure/ freezer failure	12
Vacation and moving tips	12
Short vacations	12
Long vacations	12
Moving	13
Avoid service checklist	14
Freezer does not run	14
Freezer runs too much or too long	14
Temperature inside freezer is too cold	14
Temperature inside freezer is too warm	15
Temperature of external freezer surface is warm	15
Louder sound levels whenever freezer is on	15
Louder sound levels when compressor comes on	15
Popping or cracking sound when compressor comes on	15
Bubbling or gurgling sound, like water boiling	15
Vibrating or rattling noise	15

Moisture forms on inside freezer walls	16
Moisture forms on outside of freezer	16
Odor in freezer	16
Lid problems	16
Light bulb is not on	16
Sample freezer warranty	17
SECTION B - AIR FLOW	18
SECTION C - ELECTRICAL CIRCUITS	19
The compressor/evaporator fan motor circuit	19
The defrost circuit	20
Defrost timer motor circuit	21
Freezer interior light	21
Power on light	21
SECTION D - REFRIGERATION SYSTEM & SERVICE	22
Safety	22
Soldering	22
Refrigeration system	22
Refrigerant cycle	24
Low or high side leak or undercharge	24
Test for refrigerant leaks	24
Procedure for checking condenser leaks	24
Evacuating and recharging	25
Equipment needed for evacuation & recharging	25
Installing evacuation and recharging equipment	25
Evacuating system	26
Charging the system	26
Final leak test	27
SECTION E - Troubleshooting Chart	28
Compressor will not run	28
Compressor runs, but no refrigeration	28
Compressor short cycles	28
Compressor runs too much or 100%	29
Noisy	29
Freezer too warm	30
Evaporate or blocked with ice	30
SECTION F - TEARDOWN	31
Removing interior light shield	31
Removing interior light bulb	31
Removing interior light socket	31
Removing interior light switch	31
Removing lid inner liner and seal	32
Removing lid handle	32
Removing lock mechanism	33
Removing power on lamp	33
Removing the machine compartment cover	33
Removing the hinges	34
Removing lid	34
Removing the lid's outer panel	34
Removing the food baskets	35
Removing the lower basket rails	35
Removing the wire shelf	35
Removing the cold control knob	35
Removing the cold control and fan housing cover	36
Removing the cold control	36
Releasing the top of the evaporator cover	37

Removing the evaporator fan assembly _____	37
Removing the evaporator fan blade _____	38
Removing the evaporator fan mounting bracket _____	38
Removing the defrost termination thermostat _____	38
Removing the defrost heater _____	39
Removing the evaporator cover _____	39
Removing the drain pan _____	39
Removing the filter-drier _____	40
Removing the evaporator _____	40
Replacing the compressor _____	41
To flush the system _____	41
Using dry nitrogen to flush the system _____	41
Using refrigerant to flush the system _____	41
Installing a new compressor _____	42
Removing the defrost timer _____	43
Replacing the condenser _____	44
Replacing the breaker collar trim _____	44
Removing the trim _____	45
Removing the end caps _____	45

QUICK REFERENCE SHEET

1. Serial nameplate location: on the left side of the freezer, above the machine compartment.



2. Serial number breakdown.

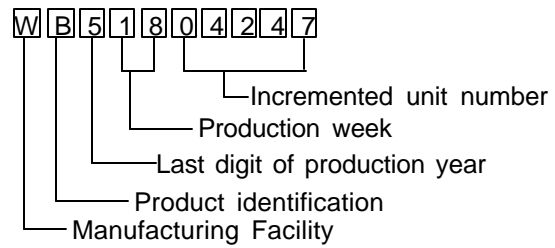

3. Tech sheet location: Rear of freezer on left side.



QUICK REFERENCE SHEET

Refrigerant Charge

Refer to serial name plate.

Electrical Specifications

Refer to serial name plate.

Temperature Control

7.3° F. cut-in, -4.9° F. cut-out @ number 1 setting.

Defrost Control

Defrost cycle

30 minutes every 12 hours

Defrost thermostat

Closes at 10°F. and opens at 50°F.

Performance (Control set at number 1 setting)

Room ambient

70°F.

90°F.

Freezer compartment temperatures

5 to 12°F.

5 to 12°F.

Percent running time

30-40%

45-55%

Wattage range (Last 1/3 of cycle)

110-125

115-130

Suction pressure (Cut-in, cut-out), PSIG

14-0

14-0

High side pressure (Last 1/3 of cycle), PSIG

110-125

150-165

SYSTEM SCHEMATIC

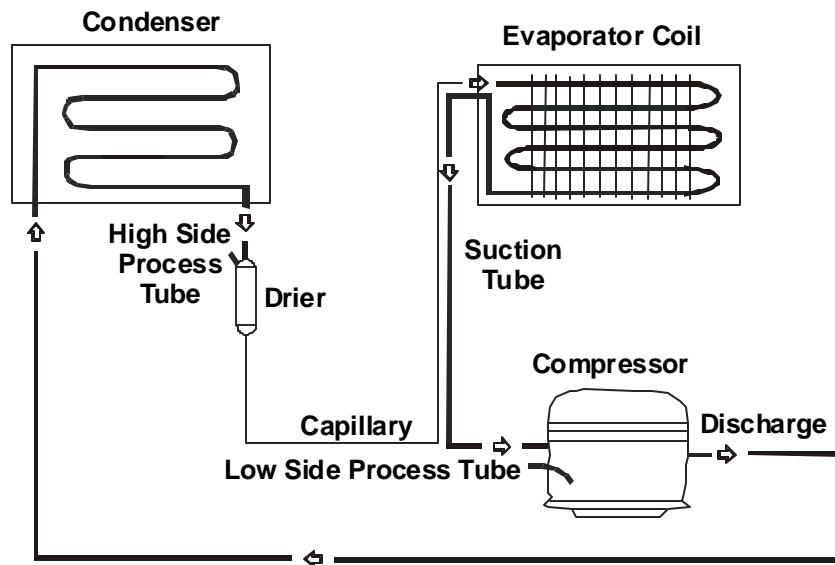

Sample Wiring Diagram

CAUTION: DISCONNECT ELECTRIC CURRENT BEFORE SERVICING. LABEL ALL WIRES PRIOR TO DISCONNECTION WHEN SERVICING CONTROLS. WIRING ERRORS CAN CAUSE IMPROPER AND DANGEROUS OPERATION. VERIFY PROPER OPERATION AFTER SERVICING.

IMPORTANT
 If any green grounding wires are removed during servicing, they must be returned to their original position and properly secured.

ELECTRICAL CIRCUIT

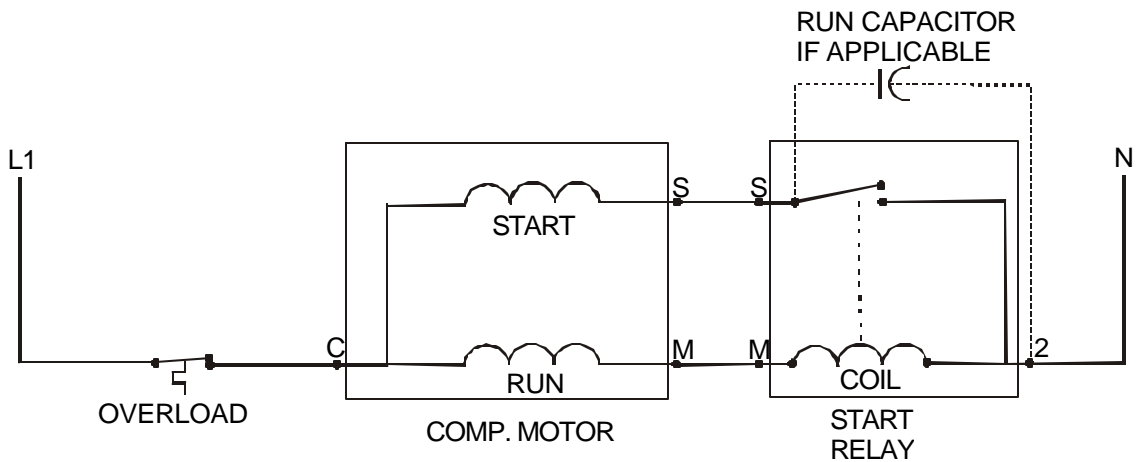
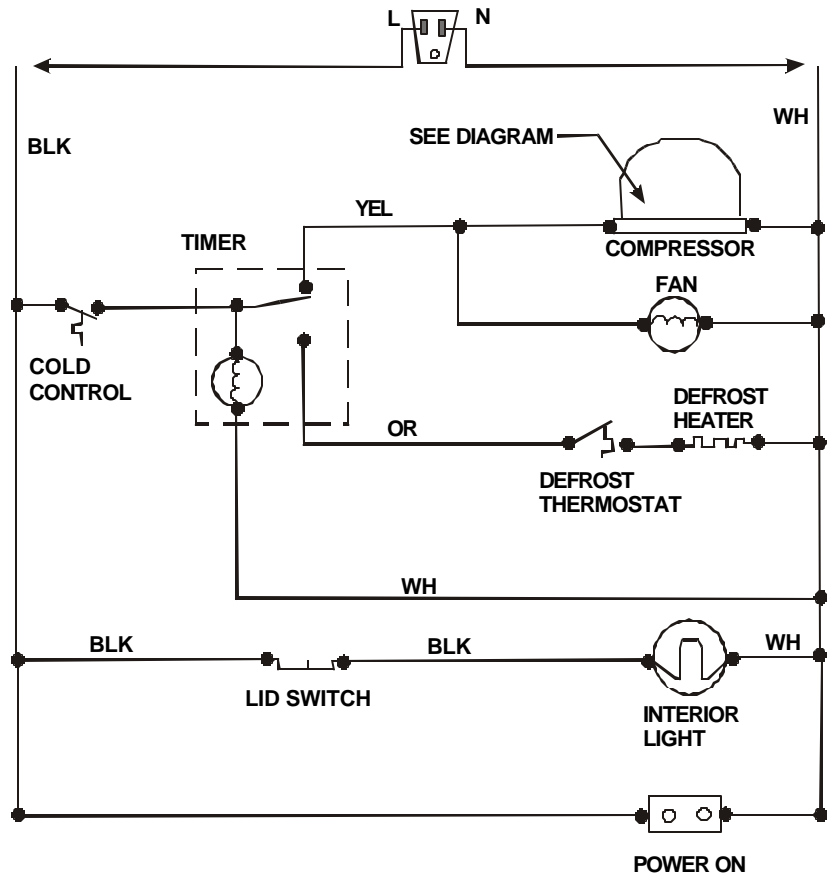

SECTION A - OWNERS GUIDE

Product Registration

The information contained in this Owner's Guide will instruct you on how to properly operate and care for your product. Please read through the information contained in your literature pack to learn more about your new appliance.

Record Your Model and Serial Numbers

Record the Model No. and Serial No. of this freezer in the space provided below.

Model No. _____

Serial No. _____

Register Your Product

The self-addressed PRODUCT REGISTRATION CARD should be filled in completely, signed and returned to Electrolux Home Products.

Note: This Owner's Guide provides operating instructions for your model. Use your freezer only as instructed in this Owner's Guide.

Energy Saving Ideas:

- The freezer should be located in the coolest area of the room, away from heat producing appliances or heating ducts, and out of direct sunlight.
- Let hot foods cool to room temperature before placing in the freezer. Overloading the freezer forces the compressor to run longer. Foods that freeze too slowly may lose quality or spoil.
- Be sure to wrap foods properly and wipe containers dry before placing them in the freezer. This cuts down on frost build-up inside the freezer.
- Freezer baskets should not be lined with aluminum foil, wax paper, or paper toweling. Liners interfere with cold air circulation, making the freezer less efficient.
- Organize and label food to reduce lid openings and extended searches. Remove as many items as needed at one time, and close lid as soon as possible.

Important Safety Instructions

Proper Disposal of Your Refrigerator/Freezer

WARNING Risk of child entrapment. Child entrapment and suffocation are not problems of the past. Junked or abandoned refrigerators or freezers are still dangerous — even if they will sit for “just a few days.” If you are getting rid of your old refrigerator or freezer, please follow the instructions below to help prevent accidents.

BEFORE YOU THROW AWAY YOUR OLD REFRIGERATOR/FREEZER:

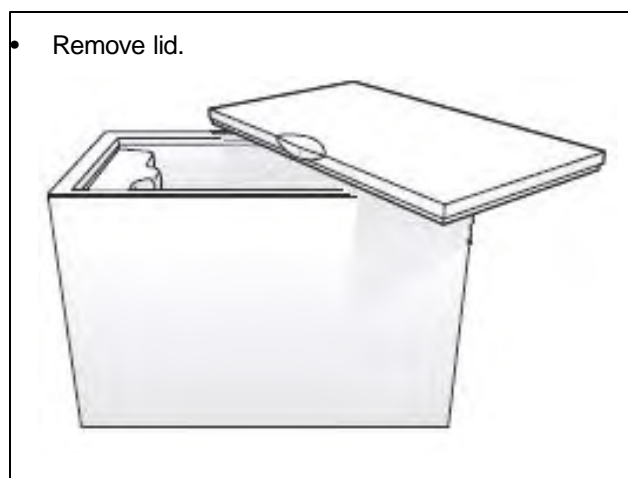

WARNING Avoid fire hazard or electric shock. Do not use an extension cord or an adapter plug. Do not remove any prong from power cord.

Grounding type wall receptacle.

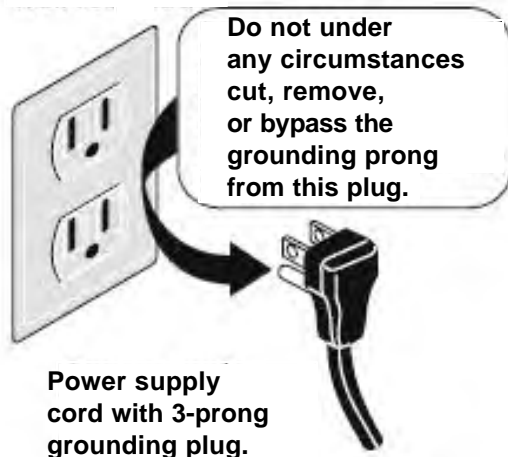

⚠ WARNING Read all instructions before using this freezer.

For Your Safety

Do not store or use gasoline or other flammable vapors and liquids in the vicinity of this or any other appliance. Read product labels for flammability and other warnings.

⚠ WARNING Child Safety

- Destroy carton, plastic bags, and any exterior wrapping material immediately after the freezer is unpacked. Children should never use these items for play. Cartons covered with rugs, bedspreads, plastic sheets or stretch wrap may become airtight chambers and can quickly cause suffocation.
- **A child might suffocate if he crawls into a freezer to hide or play. Remove the door of a freezer when not in use, even if you plan to discard the freezer.** Many communities have laws requiring you to take this safety precaution.
- Remove and discard any spacers used to secure the shelves during shipping. Small objects are a choke hazard to children.

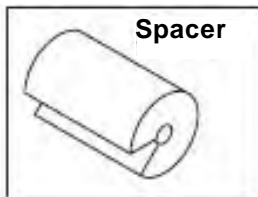

⚠ WARNING Electrical Information

These guidelines must be followed to ensure that safety mechanisms in the design of this freezer will operate properly.

- **Refer to the serial plate for correct electrical rating.** The power cord of the appliance is equipped with a three-prong grounding plug for protection against shock hazards. It must be plugged directly into its own properly grounded three prong receptacle, protected with a 15 amp time delay fuse or circuit breaker. The receptacle must be installed in accordance with the local codes and ordinances. Consult a qualified electrician. Receptacles protected by Ground Fault Circuit Interrupters (GFCI) are NOT RECOMMENDED. **DO NOT use an extension cord or adapter plug.**

- If voltage varies by 10 percent or more, freezer performance may be affected. Operating the freezer with insufficient power can damage the motor. Such damage is not covered under the warranty. If you suspect your household voltage is high or low, consult your power company for testing.
- To prevent the freezer from being turned off accidentally, do not plug unit into an outlet controlled by a wall switch or pull cord.
- Do not pinch, knot, or bend power cord in any manner.

⚠ WARNING Other Precautions

- Never unplug the freezer by pulling on the power cord. Always grip the plug firmly and pull straight out from the receptacle.
- Turning the control to OFF turns off the compressor, but does not disconnect power to other electrical components.

First Steps

Before starting the freezer, follow these important first steps:

Installation

- Choose a place that is near a grounded electrical outlet.
- The freezer should be located where surrounding temperatures will not exceed 110°F (43°C). Temperatures of 32°F (0°C) and below will NOT affect freezer operation. Additional compressor heaters are not recommended.
- Allow space around the unit for good air circulation. Leave a 3 inch (75 mm) space on all sides of the freezer for adequate circulation.

Leveling

The freezer must have all bottom corners resting firmly on a solid floor. The floor must be strong enough to support a fully loaded freezer.

NOTE: It is VERY IMPORTANT for your freezer to be level in order to function properly. If the freezer is not leveled during installation, the lid may be misaligned and not close or

seal properly, causing cooling, frost, or moisture problems.

To Level Chest Unit:

If needed, add metal or wood shims between feet pads and floor.

Cleaning

- Wash any removable parts, the freezer interior, and exterior with mild detergent and warm water. Wipe dry. **DO NOT USE HARSH CLEANERS ON THESE SURFACES.**
- Do not use razor blades or other sharp instruments, which can scratch the appliance surface when removing adhesive labels. Any glue left from the tape can be removed with a mixture of warm water and mild detergent, or touch the residue with the sticky side of tape already removed.

DO NOT REMOVE THE SERIAL PLATE.

Lid removal

See Instructions on Hinge label. (UNPLUG THE UNIT.)

Setting the Temperature Control



COLD CONTROL

Cool Down Period

- For safe food storage, allow 4 hours for freezer to cool down completely. The freezer will run continuously for the first several hours. Foods that are already frozen may be placed in freezer after the first few hours of operation. Unfrozen foods should

NOT be loaded into freezer until freezer has operated for 4 hours.

- When loading freezer, freeze only 3 pounds of fresh food per cubic foot of freezer space at one time. Distribute packages to be frozen evenly throughout the freezer. It is not necessary to turn control knob to a colder setting while freezing food.

Temperature Control

The temperature control is located inside the freezer. The temperature is factory preset to provide satisfactory food storage temperatures. However, the temperature control is adjustable to provide a range of temperatures for your personal satisfaction. If a colder temperature is desired, turn the temperature control knob toward COLDEST and allow several hours for temperatures to stabilize between Cold Control adjustments.

Freezer Optional Features

NOTE: Your freezer may have some, or all of the features listed below. Become familiar with these features, and their use and care.

Power On Light

The Power On Light indicates that the freezer is properly connected to electrical power. The light glows even when the temperature control is turned to OFF. If the light goes out, refer to "Freezer does not run" in the Avoid Service Checklist.

Security Lock with Pop-Out Key

This security lock fastens the door snugly, ensuring that stored food is secure. To lock or unlock the freezer, push the key into the lock and turn. The key pops out of the lock after it has been turned.

Interior Light

The light comes on automatically when the lid is opened. To replace the light bulb, turn the temperature control to OFF and unplug the electrical cord. Replace the old bulb with a bulb of the same wattage.

Slide-Aside Basket

This basket helps organize odd-shaped items. To reach

other packages in the freezer, slide the basket aside or lift out.

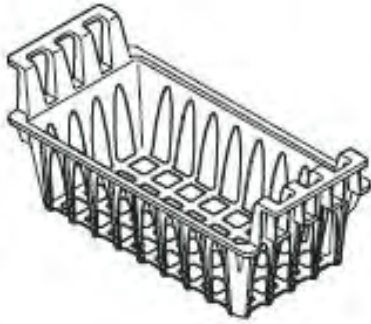

Slide-Aside Basket

Care and Cleaning

CAUTION: Damp objects stick to cold metal surfaces. Do not touch interior metal surfaces with wet or damp hands.

Your freezer is frost-free and defrosts automatically, but should be cleaned occasionally.

CAUTION: Freezer must be unplugged (to avoid electrical hazard) from power source when cleaning unit.

Cleaning the Inside

Wash inside surfaces of the freezer with a solution of two tablespoons of baking soda in one quart (1.136 liters) warm water. Rinse and dry. Wring excess water out of the sponge or cloth when cleaning in the area of the controls, or any electrical parts.

Wash the removable parts with the baking soda solution mentioned above, or mild detergent and warm water. Rinse and dry. **Never** use metallic scouring pads, brushes, abrasive cleaners, or alkaline solutions on any surface. **Do not** wash removable parts in a dishwasher.

CAUTION: Never attempt to operate freezer with out this shelf correctly installed as it will not have adequate air circulation to function properly.

Wire Shelf Removal

Slide top prongs of wire shelf out of their locating holes in the top side of the cabinet. Lift and slide shelf at an angle to guide it out from the locating slots at the bottom

of the cabinet and remove. Reverse this procedure to reinstall the shelf.

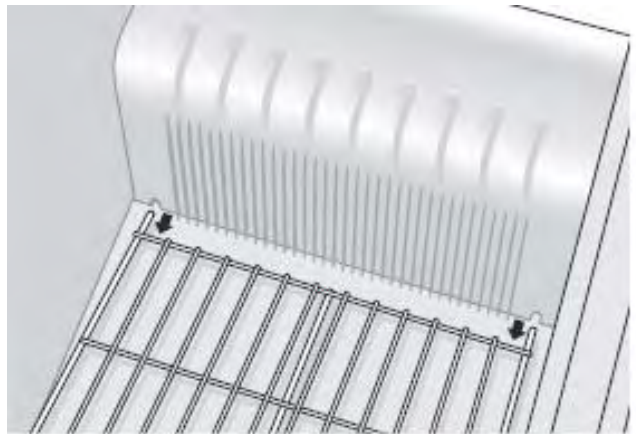

Cleaning the Outside

Wash the cabinet with warm water and mild liquid detergent. Rinse well and wipe dry with a clean soft cloth. Replace parts and food.

Power Failure/ Freezer Failure

⚠ WARNING If leaving freezer lid open while on vacation, make certain that children cannot get into the freezer and become entrapped.

Vacation and Moving Tips

Short Vacations: Leave the freezer operating during vacations of less than three weeks.

Long Vacations: If the freezer will not be used for several months, remove all food and unplug the power cord.

Clean and dry the interior thoroughly. To prevent odor and mold growth, leave the freezer lid open slightly, blocking it open if necessary.

Moving: Disconnect the power cord plug from the wall outlet. Remove foods and clean the freezer. Secure all loose items, such as baskets, by taping them securely in place to prevent damage. In the moving vehicle, secure freezer in an upright position, and secure to prevent movement. Also protect outside of freezer with a blanket, or similar item.

NOTE: Do not open freezer lid unnecessarily if freezer is off for several hours.

If a power failure occurs, frozen foods will stay frozen for at least 24 hours if the freezer is kept closed. If the power failure continues, pack seven or eight pounds of dry ice into the freezer every 24 hours. Look in the Yellow Pages under "Dry Ice," "Dairies," or "Ice Cream Manufacturers" for local dry ice suppliers. Always wear gloves and use caution when handling dry ice.

If the freezer has stopped operating, see "Freezer does not run" in the Avoid Service Checklist Section of this manual. If you cannot solve the problem, call an authorized servicer immediately. If the freezer remains off for several hours, follow the directions above for the use of dry ice during a power failure. If necessary, take the food to a local locker plant until the freezer is ready to operate. Look in the Yellow Pages under "Frozen Food Locker Plants."

Avoid Service Checklist	Before calling for service, review this list. It may save you both time and expense. This list includes common occurrences that are not the result of defective workmanship or materials in this appliance.
OCCURRENCE	SOLUTION
Freezer Does Not Run.	<ul style="list-style-type: none"> • Check to ensure that freezer is not plugged into a circuit that has ground fault interrupt. If you are unsure about the outlet, have it checked by a certified technician. • Temperature control is in the OFF position. See Setting the Temperature Control section. • Freezer may not be plugged in or plug may be loose. Be sure plug is tightly pushed into electrical outlet. • House fuse has blown or circuit breaker has tripped. Check / reset circuit breaker or replace fuse with 15 amp time delay fuse. • Power outage. Check house lights. Call local electric company.
Freezer Runs Too Much or Too Long.	<ul style="list-style-type: none"> • Room or outside weather is too hot. It is normal for the freezer to work harder under these conditions. • Freezer has recently been disconnected for a period of time. Freezer requires 4 hours to cool down completely. • Large amounts of warm water or hot food have been stored recently. Warm food will cause the freezer to run more until the desired temperature is reached. • Lid is kept open too long or too frequently. Warm air enters the freezer every time the lid is opened. Open the lid less often. • Freezer lid may be slightly open. See OCCURRENCE “Lid Problems” • Temperature control is set too cold. Turn the control knob to a warmer setting. Allow several hours for the temperature to stabilize. • Freezer gasket is dirty, worn, cracked, or poorly fitted. Clean or change gasket. Leaks in the lid seal will cause freezer to run longer in order to maintain desired temperature.
Temperature Inside Freezer is Too Cold.	<ul style="list-style-type: none"> • Temperature control is set too cold. Turn the control

OCCURRENCE	SOLUTION
<p>Temperature Inside Freezer is Too Warm.</p>	<ul style="list-style-type: none"> • Temperature control is set too warm. Turn the control to a colder setting. Allow several hours for the temperature to stabilize. • Lid is kept open too long or too frequently. Warm air enters the freezer every time the lid is opened. Open the lid less often. • Freezer lid may be slightly open. See OCCURRENCE “Lid Problems” • Large amounts of warm water or hot food have been stored recently. Wait until the freezer has had a chance to reach its selected temperature. • Freezer has recently been disconnected for a period of time. Freezer requires 4 hours to cool down completely.
<p>Temperature of External Freezer Surface is Warm.</p>	<ul style="list-style-type: none"> • The exterior freezer walls can be as much as 30°F warmer than room temperature. This is normal while the compressor works to transfer heat from inside the freezer cabinet.
<p>Louder Sound Levels Whenever Freezer is ON.</p>	<ul style="list-style-type: none"> • Modern freezers have increased storage capabilities and more even temperatures. They require a high efficiency compressor. When the surrounding noise level is low, you might hear the compressor running while it cools the interior.
<p>Louder Sound Levels When Compressor Comes ON.</p>	<ul style="list-style-type: none"> • Freezer operates at higher pressures during the start of the ON cycle. This is normal. Sound will level off or disappear as freezer continues to run.
<p>Popping or Cracking Sound When Compressor Comes ON.</p>	<ul style="list-style-type: none"> • Metal parts undergo expansion and contraction, as in hot water pipes. This is normal. Sound will level off or disappear as freezer continues to run.
<p>Bubbling or Gurgling Sound, Like Water Boiling.</p>	<ul style="list-style-type: none"> • Refrigerant (used to cool freezer) is circulating throughout the system. This is normal.
<p>Vibrating or Rattling Noise.</p>	<ul style="list-style-type: none"> • Freezer is not level. It rocks on the floor when it is moved slightly. Level the unit. Refer to “Leveling” in the First Steps section. • Floor is uneven or weak. Freezer rocks on the floor when it is moved slightly. Be sure floor can adequately support freezer. Level the freezer by putting wood or metal shims under part of the freezer. • Freezer is touching the wall. Level the freezer or move freezer slightly. Refer to “Leveling” in the First Steps section.

OCCURRENCE	SOLUTION
<p>Moisture Forms On Inside Freezer Walls.</p>	<ul style="list-style-type: none"> • Weather is hot and humid, which increases internal rate of frost buildup. This is normal. • Lid is slightly open. See OCCURRENCE “Lid Problems”. • Lid is kept open too long, or is opened too frequently. Open the Lid less often.
<p>Moisture Forms On Outside of Freezer.</p>	<ul style="list-style-type: none"> • Lid is slightly open, causing the cold air from inside the freezer to meet warm moist air from outside. See OCCURRENCE “Lid Problems”.
<p>Odor In Freezer.</p>	<ul style="list-style-type: none"> • Interior needs to be cleaned. Clean interior with sponge, warm water and baking soda. • Foods with strong odors are in the freezer. Cover the food tightly.
<p>Lid Problems.</p>	<ul style="list-style-type: none"> • Freezer is not level. It rocks on the floor when it is moved slightly. This condition can force the cabinet out of square and misalign the lid. Refer to “Leveling” in the First Steps section. • Floor is uneven or weak. Freezer rocks on the floor when it is moved slightly. Be sure floor can adequately support freezer. Level the freezer by putting wood or metal shims under the freezer or brace the floor supporting the freezer.
<p>Light Bulb is Not On.</p>	<ul style="list-style-type: none"> • Light bulb is burned out. Follow directions under “Interior Light” in the “Freezer Features” section. • No electric current is reaching the freezer. See OCCURRENCE “Freezer does not run”.

Sample Freezer Warranty Always Refer to Warranty with Product

Your freezer is protected by this warranty

	WARRANTY PERIOD	THROUGH OUR AUTHORIZED SERVICERS, WE WILL:	THE CONSUMER WILL BE RESPONSIBLE FOR:
FULL ONE-YEAR WARRANTY	One year from original purchase date.	Pay all costs for repairing or replacing any parts of this appliance which prove to be defective in materials or workmanship	Costs of service calls that are listed under NORMAL RESPONSIBILITIES OF THE CONSUMER. *
LIMITED 2ND-5TH YEAR WARRANTY (Sealed System)	Second through fifth years from original purchase date.	Repair or replace any parts in the Sealed Refrigeration System (compressor, condenser, evaporator, drier and tubing) which prove to be defective in materials or workmanship, and provide the labor to install such part.	Diagnostic costs and any removal, transportation and reinstallation costs, which are required because of service. Costs for labor, parts and transportation other than with respect to the Sealed Refrigeration System.
LIMITED 6TH-10TH YEAR WARRANTY (Compressor Only)	Sixth through tenth years from original purchase date.	Provide a replacement for any compressor, which proves to be defective in materials or workmanship.	Diagnostic costs and any removal, transportation and reinstallation costs, which are required because of service. Costs for labor, parts and transportation other than the cost of the replacement compressor itself.
LIMITED WARRANTY (Applicable to the State of Alaska)	Time periods listed above.	All of the provisions of the full and limited warranties above and the exclusions listed below apply.	Costs of the technician's travel to the home and any costs for pick up and delivery of the appliance required because of service.
THREE-YEAR LIMITED FOOD SPOILAGE PLAN	During the first three years from original purchase date.	If food loss results because of defects in materials or workmanship during the time periods listed above, and applies to the limitations stated in the normal responsibilities of the consumer listed below, Electrolux will reimburse the consumer for the actual food spoilage loss in excess of \$5.00 per occurrence, but not to exceed a cumulative maximum payment of \$100.00 , provided the food losses: A) Are reported and the food shown to any Electrolux authorized servicer within 24 hours of the discovery of the loss. B) Are not occasioned by either the manual disconnection of the electrical power within the premises of the owner or a general power failure. C) Occur even though the owner exercised reasonable care and diligence to save food per suggestions furnished with	

In the U.S.A., your appliance is warranted by Electrolux Home Products, Inc. We authorize no person to change or add to any of our obligations under this warranty. Our obligations for service and parts under this warranty must be performed by us or an authorized Electrolux Home Products, Inc. servicer. In Canada, your appliance is warranted by Electrolux Canada Corp.

*NORMAL RESPONSIBILITIES OF THE CONSUMER

This warranty applies only to products in ordinary household use, and the consumer is responsible for the items listed below:

1. Proper use of the appliance in accordance with instructions provided with the product.
2. Proper installation by an authorized servicer in accordance with instructions provided with the appliance and in accordance with all local plumbing, electrical and/or gas codes.
3. Proper connection to a grounded power supply of sufficient voltage, replacement of blown fuses, repair of loose connections or defects in house wiring.
4. Expenses for making the appliance accessible for servicing, such as removal of trim, cupboards, shelves, etc., which are not a part of the appliance when it was shipped from the factory.
5. Damages to finish after installation.
6. Replacement of light bulbs and/or fluorescent tubes (on models with these features).

EXCLUSIONS

This warranty does not cover the following:

1. CONSEQUENTIAL OR INCIDENTAL DAMAGES SUCH AS PROPERTY DAMAGE AND INCIDENTAL EXPENSES RESULTING FROM ANY BREACH OF THIS WRITTEN OR ANY IMPLIED WARRANTY.
NOTE: Some states do not allow the exclusion or limitation of incidental or consequential damages, so this limitation or exclusion may not apply to you.
2. Service calls which do not involve malfunction or defects in workmanship or material, or for appliances not in ordinary household use. The consumer shall pay for such service calls.
3. Damages caused by services performed by servicers other than Electrolux Home Products, Inc. or its authorized servicers; use of parts other than genuine Electrolux Home Products, Inc. parts; obtained from persons other than such servicers; or external causes such as abuse, misuse, inadequate power supply or acts of God.
4. Products with original serial numbers that have been removed or altered and cannot be readily determined.

IF YOU NEED SERVICE

Keep your bill of sale, delivery slip, or some other appropriate payment record. The date on the bill establishes the warranty period should service be required. If service is performed, it is in your best interest to obtain and keep all receipts. This written warranty gives you specific legal rights. You may also have other rights that vary from state to state. Service under this warranty must be obtained by contacting Electrolux Home Products, Inc.

This warranty only applies in the 50 states of the U.S.A., Puerto Rico, and Canada. Product features or specifications as described or illustrated are subject to change without notice. All warranties are made by Electrolux Home Products, Inc. In Canada, your appliance is warranted by Electrolux Canada Corp.

USA
800-944-9044 Electrolux Home Products Inc
P.O. Box 212387 Augusta, GA. 30917

Canada
866-213-9397 Electrolux Canada Corp.
6150 McLauhin Road Mississauga Ontario
L5R 4C2

SECTION B - AIR FLOW

The fin and tube evaporator is mounted to the left side of the of the freezer compartment.

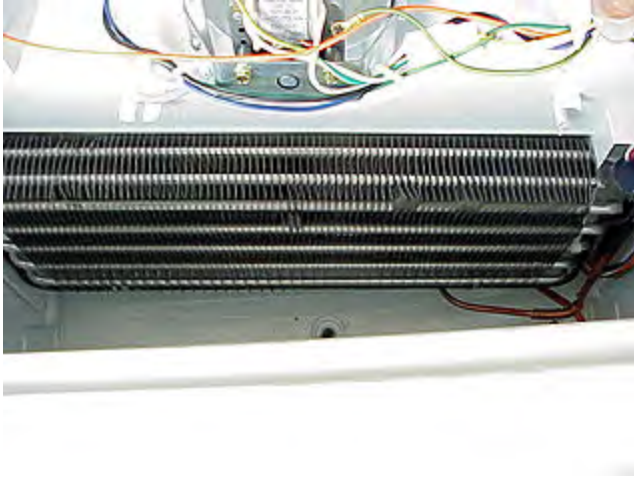

The air is cooled as it is drawn through the evaporator, then forced out across the top of the food through the holes in each side of the control cover.



The evaporator fan is mounted to the evaporator cover above the evaporator.



Whenever the compressor is running the evaporator fan runs. The fan draws air through the slots in the bottom of the evaporator cover



SECTION C - ELECTRICAL CIRCUITS

There are (5) electrical circuits in the frost-free freezer:

1. The Compressor/Evaporator Fan Motor Circuit.

This circuit is made up of the cold control, contacts 1 and 2 of the defrost timer, compressor, and evaporator fan motor.

When power is applied to the freezer, line 1 is connected to the cold control. The cold control is a hydraulically operated switch that senses the temperature in the freezer. When the temperature in the freezer raises above the cold control setting the contacts close applying power to terminal (1) of the defrost timer.

The defrost timer is a single pole double throw switch that is operated by a motorized cam. The cam turns one revolution every (12) hours that power is supplied to the motor. The contacts between terminals (1) and (4), of the defrost timer, are closed for 11 hours and 30 minutes of the 12 hour cycle providing power to the compressor and evaporator fan motor circuits.

The compressor motor and the evaporator fan motor are connected electrically in parallel. Power from terminal (4) of the defrost timer is applied to the over load protector of the compressor. The overload

protector is a thermal device that senses a temperature of the compressor shell and prevents damage to compressor motor by removing power if the compressor overheats.

The overload protector is connected to pin the "C" of the compressor. Pin "C" of the compressor is connected internally in the compressor to the end of the start and run windings of the compressor motor. The other end of the run winding is internally connected to pin "M" of the compressor, while the other end of the start winding is internally connected to pin "S" of the compressor.

The compressor start relay is pushed on over compressor pins "M" and "S". The start relay is a current sensitive relay, made up of a coil and a set of contacts. The coil of the relay is connected between pin "M" of the compressor and terminal (2) of the relay, which in turn is connected to neutral. The contacts of the relay are connected between terminal "S" of the compressor and terminal (2) of the relay.

The evaporator fan motor is connected between the defrost timer terminal (4) and neutral. This puts evaporator fan motor electrically in parallel with the overload protector, compressor and start relay.

Electrical Current Flow

When the contacts of the cold control close, powers is applied to terminal one of the defrost timer. If the

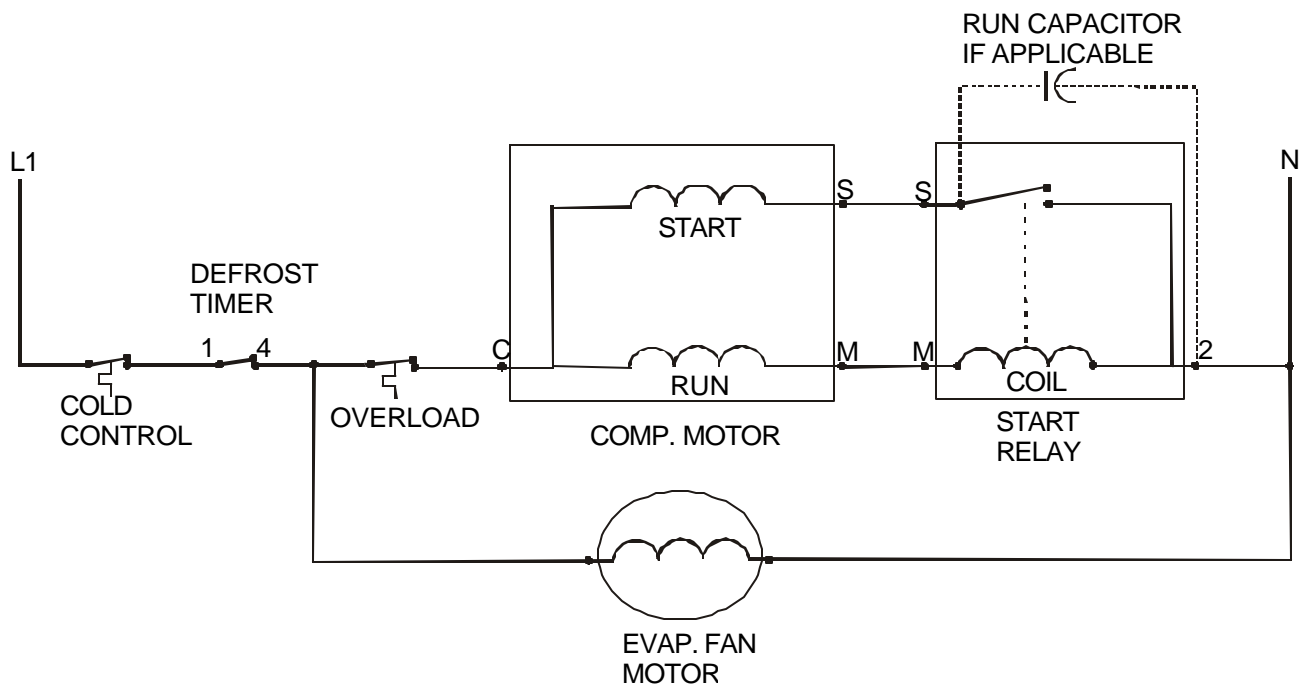

defrost timer is in the run mode contacts (1) to (4) are closed and powers applied to the overload protector of the compressor. Current flows through the overload protector applying powers to both the start and run windings of the compressor. When the compressor is trying to start the only path for current flow is through the circuit formed by the run winding and the coil of the start relay to neutral.

Because of the relatively high starting resistance of the compressor. The current through the coil is high enough to energize the relay. This closes the contacts of the start relay and connects the start winding to neutral. The current through the start winding induces a second, out-of-phase, magnetic field in the stator and starts the motor. As the motor speed increases, the run winding current is reduced.

At a predetermined condition, the run winding current, which is also the current through the relay coil, drops to a value below that necessary to hold up the relay armature. The armature drops and opens a start relay contacts and takes the start winding out of the circuit.

The evaporator fan motor is connected between terminal (4), of the defrost timer, and neutral. This connects the evaporator fan electrically in parallel with the compressor. This is helpful when troubleshooting because, if either one of the components operate, this indicates that the cold control and defrost timer contacts (1) to (4) are good and at the problem is in the other circuit. If neither operate then the cold control and defrost timer should be checked first.

2. The Defrost Circuit.

The defrost cycle, operates for 30 minutes out of every 12 hours of run time, to remove the frost from the evaporator. The defrost circuit is made up of the cold control, contacts one and two of the defrost timer, defrost thermostat and the defrost heater.

When the defrost cycle is in operation, the cold control contacts are closed applying power to terminal (1) of the defrost timer. Terminal (1) is then closed to terminal (2) of the defrost timer, which applies power to the defrost thermostat.

The defrost thermostat is a bimetal device that protects the evaporator from overheating during the defrost cycle and damaging the cabinet. The contacts of the defrost thermostat are closed at normal freezer temperatures. Power passes to the contacts of the defrost thermostat and is applied to the defrost heater.

Electrical Current Flow

Since the defrost timer contacts are electrically after the cold control, the contacts of the cold control must be closed before the defrost cycle can operate.

With the contacts of the cold control close, when the cam of the defrost timer closes contacts (1) to (2), powers is applied to defrost heater through the normally close contacts of the defrost thermostat. The other end of the defrost heater is connected to neutral, which completes the circuit and allows current flow through the defrost heater.

The specifications of the defrost thermostat are that it closes at 10°F and opens at 50°F. Although the defrost timer provides power to the circuit for 30 minutes, the heating element provides enough heat to open the contacts of the defrost thermostat in about 10 to 12 minutes.

The rest of the time is used to allow the moisture to drip off the evaporator so it does not refreeze when the compressor starts.

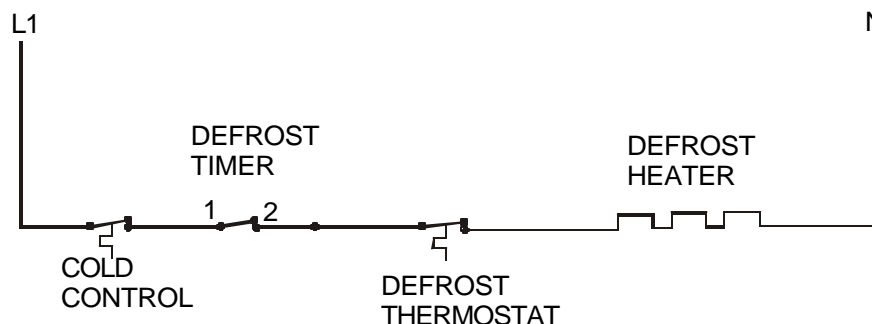

3. Defrost Timer Motor Circuit.

The defrost timer motor circuit is made up of the cold control and the defrost timer motor. Whenever the cold control contacts are closed. Power is applied to the defrost timer motor. This means that the defrost timer motor only runs whenever the cold control contacts are closed.

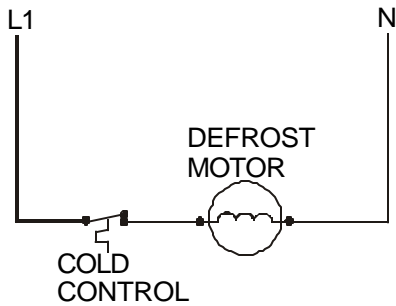

4. Freezer Interior Light.

The freezer interior light circuit is made up of a spring loaded lid switch and a (25) Watt light bulb. Whenever the lid is raised the contacts of the spring loaded switch closes, applying power to the light bulb.

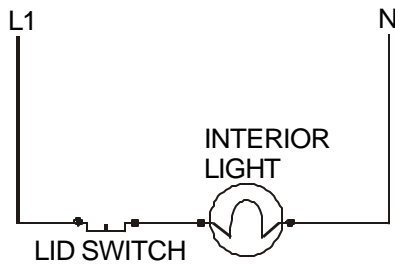

5. Power On Light.

The power on light is connected between line and neutral and glows anytime power is applied to the freezer.

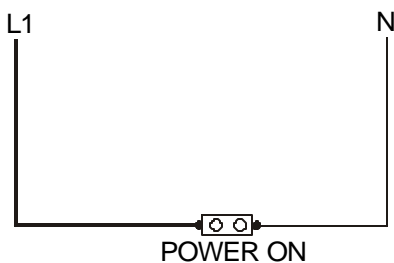

SECTION D - REFRIGERATION SYSTEM & SERVICE

NOTICE: Instructions given here are furnished as a guide. Persons attempting to use these to make repairs to the sealed refrigeration system should have a working knowledge of refrigeration and previous training on sealed system repair.

Safety

WARNING **Compressor Testing:** Whenever testing a compressor, extreme caution should be used to prevent damaging the terminals. A compressor with a damaged terminal or a ground terminal winding can expel a terminal from its insulated housing when the compressor is energized. If this happens, a mixture of refrigerant and oil will be released that could be ignited by an external heat source (open flame, heater, etc.). Also, if there is air in the system when it happens, a spark at the compressor shell could ignite the refrigerant and oil mixture.

WARNING **Charging Sealed Systems:** Overcharging a freezer system with refrigerant can be dangerous. If the overcharge is sufficient to immerse the major parts of the motor and compressor in liquid refrigerant, a situation has been created which, when followed by a sequence of circumstances, can lead to the compressor shell seam separating.

A hydraulic block occurs preventing the compressor from starting. This condition is known as locked rotor. Electrical current continues to flow through the compressor motor winding which becomes, in effect, electrical resistance heaters. The heat produced begins to vaporize the excess refrigerant liquid, causing a rapid increase in system pressure. If the compressor protective devices fail, the pressure within the system may rise to extremes far in excess of the design limits. Under these conditions, the weld seam around the compressor

shell can separate with explosive force, spewing oil and refrigerant vapor which could ignite.

To eliminate this exceedingly rare but potential hazard, never add refrigerant to a seal system. If refrigerant is required, evacuate the existing charge and recharge with the correct measured amount of refrigerant specified for the system.

Soldering

CAUTION Wear the proper and approved safety glasses when working with or on any pressurized system or equipment. Have an approved dry type fire extinguisher handy when using any type of gas operated torch.

1. All joints to be soldered must have a proper fit. The clearance between tubes to be soldered should be from .001" to .006". It is not practical to actually measure this, however you do not want a dry fit or a loose fit. The tubing joints should overlap about the distance of their diameter except for restrictor tubes which should be inserted 1.25"
2. Clean all joint areas with fine steel wool or preferably an abrasive cloth, such as grit cloth No. 23 or "Scotch-Brite."
3. Apply a thin film of a liquid flux recommended for silver soldering to the surfaces to be joined, and to the surfaces immediately adjacent to the joint.
4. Align the tubing so that there is no stress on the joint. Do not move the tubing while the solder is solidifying or leaks will result.

CAUTION During the application of heat, use wet cloths to prevent the heat from conducting to areas other than the soldered joint. Use a sheet of metal as a heat deflector to keep the flame away from inflammable materials and painted surfaces.

5. Use a torch of adequate capacity so that the joint can be quickly heated with a minimum of heat travel to other points. Use a good grade of silver solder.
6. Solder the connections. If the tubing is properly cleaned and fluxed, solder will flow readily. Do not use an excessive amount of solder, just enough to make a good bond.

7. Allow the joint to cool then wash exterior with water to remove flux.

4. The capillary tube connects the output end of the drier to the input of the evaporator.

Refrigeration System

Basic components of a freezer are:

1. The compressor located in the machine compartment.

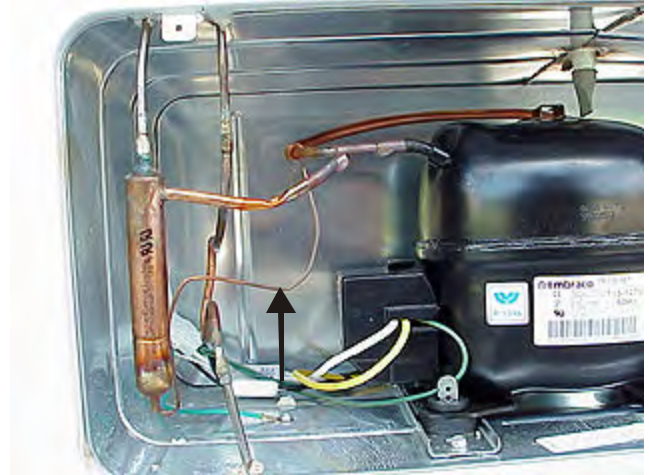

2. The condenser that is foamed to the outer walls of the cabinet.



5. The filter-drier located in the machine compartment.

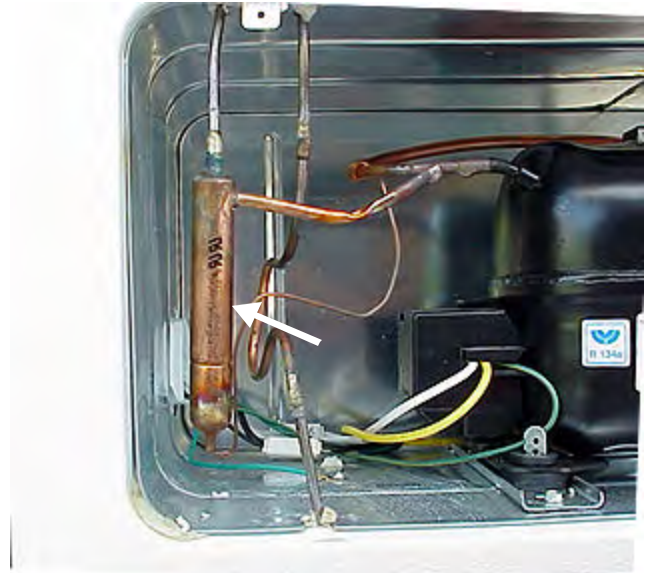

3. The evaporator located on the inside left wall of the food compartment.

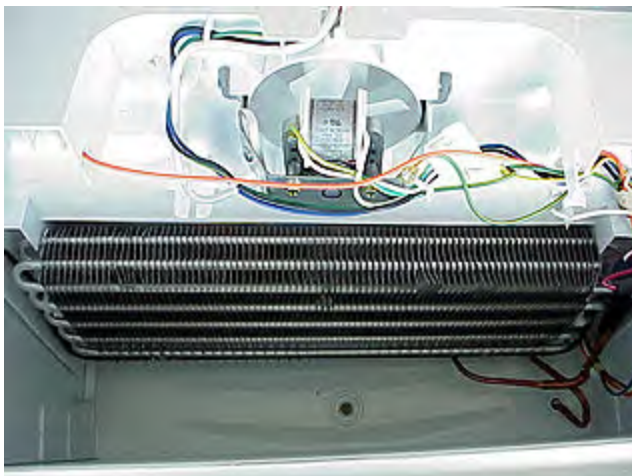

6. The suction line connects the output of the evaporator to the input side of the compressor.



Note: Portions of the capillary tube and the suction line are solder together to form the heat exchanger.

Refrigerant Cycle

The refrigerant cycle is a continuous cycle that occurs whenever the compressor is in operation. Liquid refrigerant is evaporated in the evaporator by the heat that enters the cabinet through the insulated walls and the heat introduced by the product load and door openings. The refrigerant vapor is then drawn from the evaporator, through the suction line, to the compressor. The pressure and temperature of the vapor is raised in the compressor by compression, and the vapor is then forced through the discharge valve into the discharge line and into the condenser. Air passing over the condenser surface removes heat from the high pressure vapor, which then condenses to a liquid. The liquid refrigerant flows from the condenser to the evaporator, through the small diameter liquid line (capillary tube). Before it enters the evaporator, it is sub-cooled in the heat exchanger by the low temperature suction vapor in the suction line.

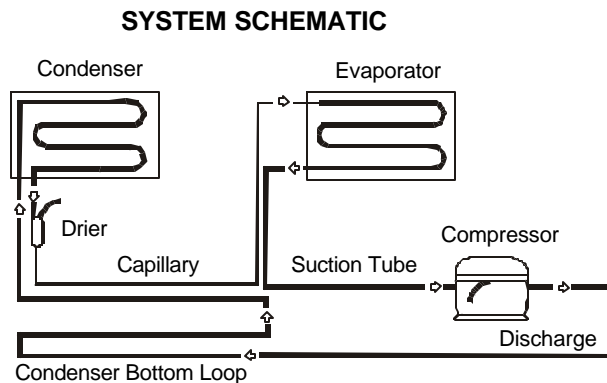

Low or High Side Leak or Undercharge

A loss of refrigerant results in excessive or continuous compressor operation; above normal freezer compartment temperature; a partially frosted evaporator (depending on the amount of refrigerant loss); above normal freezer compartment temperature; low suction pressure (vacuum) and low wattage. The condenser will be "warm to cool," again, depending on the amount of refrigerant lost.

When refrigerant is added, the frost pattern will improve; the suction and discharge pressures will rise; the condenser will become hot; and the wattage will increase. In the case of a low side refrigerant leak, resulting in a complete loss of refrigerant, the compressor will run, but

with no refrigeration. Suction pressure will drop below atmospheric pressure, and air and moisture will be drawn into the system, saturating the filter-drier.

If a slight undercharge of refrigerant is indicated, and no leak could be found after a thorough leak test, the charge can be corrected without changing the compressor.

If there is reason to believe the system has operated for a considerable length of time with no refrigerant, and the leak occurred in the evaporator, excessive amounts of moisture may have entered the system. In such cases the compressor may need to be replaced to prevent repetitive service.

If a high side leak is located and some refrigerant remains in the system, it is not necessary to change the compressor.

Test for Refrigerant Leaks

If the system is diagnosed as short of refrigerant and the system has not been recently opened, there is probably a leak in the system. Adding refrigerant without first locating and repairing the leak, or replacing the component would not permanently correct the difficulty. **THE LEAK MUST BE FOUND.** Sufficient refrigerant may have escaped to make it impossible to leak test effectively. In such cases, add a 1/4" line piercing valve to the compressor process tube. Add sufficient refrigerant to increase the pressure to 75 lb. per sq. inch. Through this procedure, slow leaks are more easily detected before discharging the system.

Note: The line piercing valve (clamp on type) should be used for adding refrigerant and test purposes only. It must be removed from the system after it has served its purpose.

Procedure for Checking Condenser Leaks

Before checking for leaks in the condenser, check all accessible system components and joints for leaks.

If a condenser leak is suspected:

1. Discharge the system by using refrigerant recovery equipment.
2. Disconnect the condenser tube from the drier and pinch off and solder both the drier and condenser tube closed.
3. Remove the discharge tube from the compressor and seal the opening to the compressor.

4. Connect a pressure gauge and access valve to the discharge tube and pressurize to 250 lbs. using dry nitrogen or carbon dioxide.

WARNING Never pressurize with oxygen. Never open a high pressure tank unless it is equipped with a pressure regulator. Never put high pressure on the dome of the compressor. Make sure the gauge and fitting is in good condition and do not leak.

5. Leave the pressure on the condenser for 24 hours. Any drop in pressure is an indication of a leak.

Evacuating and Recharging

CAUTION: Check the serial plate for the correct refrigerant type. It is extremely important to verify the type of refrigerant in the system before starting any sealed system repairs.

CAUTION: With the possible exception of the vacuum pump, all service equipment that comes in contact with R-134a during evacuation and recharging must be dedicated. Accordingly, R-134a will require a dedicated charging cylinder, manifold gauge set, process tube adaptors, and hoses. Any residual mineral oil on other tools (tubing cutter, etc.) must be thoroughly cleaned off before using on R-134a/Ester oil systems. It will be necessary to check with the manufacturer of your vacuum pump for refrigerant and oil compatibility issues.

CAUTION: If you use a vacuum pump with mineral oil to evacuate an R-134a system, it is **ABSOLUTELY ESSENTIAL** to have a shut-off valve between the pump and your manifold gauge set. The hand valve must be closed during all times when the vacuum pump is not operating. This will prevent the migration of mineral oil vapor into the R134a/Ester oil system. If the vacuum pump should stop during evacuation for any reason, the hand pump shut-off valve must be closed immediately.

CAUTION: Insure that your refrigeration hoses are specified for use with R-134a refrigerant. Research has shown that

compounds in standard refrigeration hoses may enter sealed systems and ultimately restrict the cap tube in an R-134a system.

Equipment Needed For Evacuation & Recharging:

- Heated charging cylinder.
- Standard 3-port manifold gauge set:
4 charging hoses.
Tee fitting with valve core stem removed. (Robinair No. 40396).
Hand shut-off valve (Robinair No.40380).
- Two stage vacuum pump.
- Process tube adapter kit (Robinair No. 12458).
- Tubing cutter.
- Pinch-off tool capable of making leak proof seal.
- Complete brazing torch set.
- Small 3-corner file.
- Grit cloth or Scotch-Brite.
- 45% silver solder and flux.

Installing Evacuation and Recharging Equipment:

1. Disconnect freezer from electrical supply.
2. If compressor was replaced, install correct sized process tube adaptor on process tube. If compressor was not replaced, cut process tube with tubing cutter leaving as much tube as possible and install correct size process tube adaptor.
3. Install correct sized process tube adaptor on high-side process tube.
4. Attach refrigeration service gauge manifold to system in following order:
 - Low-side (compound gauge) hose to suction side process tube adaptor.
 - High-side (pressure gauge) hose to high-side process tube adaptor.

- Center port manifold hose before hand shut-off valve to charging cylinder.
- Center port manifold hose after hand shut-off valve to vacuum pump.

Evacuating System

WARNING: R-134A SYSTEMS ARE PARTICULARLY SUSCEPTIBLE TO MOISTURE CONTAMINATION WHICH CAN ONLY BE PREVENTED BY EVACUATING THE SYSTEM FOR A MINIMUM OF 30 MINUTES TO ATTAIN A MINIMUM 29.9 INCH (500 MICRON OR LOWER) VACUUM.

To achieve the required levels of evacuation, a properly maintained two stage vacuum pump in good condition is required. It is absolutely essential to maintain your vacuum pump according to the manufacturer's instructions including required oil changes at the recommended intervals. Vacuum pump oil should always be changed after evacuating a contaminated system. Vacuum pump performance should be checked periodically with a micron gauge.

1. Make certain that charging cylinder valve, hand shut-off valve, and manifold gauge valves are closed.
2. Start vacuum pump.
3. Open hand shut-off valve and slowly open both manifold valves, turning counterclockwise, for two full rotations.

CAUTION: If high vacuum equipment is used, just crack both manifold valves for a few minutes and then open slowly for the two full turns counterclockwise. This will prevent the compressor oil from foaming and being drawn into the vacuum pump.

4. Operate the vacuum pump for a minimum of 30 minutes to a minimum of 29.9" (500 micron) vacuum.
5. Close hand shut-off valve to vacuum pump. Watch compound gauge for several minutes. If reading rises, there is a leak in the system, go to step 6. If no leak is indicated, stop vacuum pump. System is now ready for charging.
6. If a leak is indicated, stop vacuum pump and introduce a small charge of refrigerant into system by cracking valve on bottom of charging cylinder until system is pressurized to 40 or 50 lbs psig.

7. Leak test low-side. Close compound gauge. Run compressor for a few minutes and leak test high side.

When leak is found, recapture refrigerant using EPA approved recovery system Repair and go back to step 1.

Charging the System

CAUTION: Check the serial plate for the correct refrigerant type. It is extremely important to verify the type of refrigerant in the system before starting any sealed system repairs.

CAUTION: After charging the system with liquid be certain to wait at least 5 minutes before starting the compressor to give the refrigerant a chance to disperse throughout the system. Otherwise the compressor could be damaged by attempting to pump excessive quantities of liquid.

Preparing The Charging Cylinder:

1. Make certain that hand shut-off valve to vacuum pump is closed.
2. Close high-side manifold gauge valve.
3. Set charging cylinder scale to pressure indicated on cylinder pressure gauge.
4. Observe refrigerant level in sight glass. Subtract amount to be charged into system and note shut off point.
5. Open charging cylinder valve slowly and allow proper charge to enter system.
6. As soon as refrigerant in sight glass has gone down to predetermined level, close charging cylinder valve.

WARNING: DISCONNECT THE CHARGING CYLINDER HEATER AT THIS TIME TO PREVENT THE CYLINDER PRESSURE FROM EXCEEDING ITS MAXIMUM LIMITS.

7. Allow system to sit for five minutes.
8. Turn on freezer's compressor. and allow it to run for a few minutes and monitor system pressures.

9. When satisfied that the unit is operating correctly, clamp the high-side process tube with the pinch-off tool while the unit is still running.
10. Slowly open the high-side manifold gauge valve to allow the compressor to remove any refrigerant trapped in the high-side hose and the process fitting.
11. Close both of the manifold gauge valves. If the high-side gauge reading rises, the pinch-off must be corrected before proceeding.
12. Remove the high-side process tube adaptor and solder the process tube closed.
13. Clamp the low-side process tube with the pinch-off tool while the unit is running. Remove the low-side process tube adaptor and solder the process tube closed.
14. Check the process tubes for refrigerant leaks.

Final Leak Test:

1. With the refrigerator turned OFF, leak test all low-side system components.
2. Turn the unit ON and run until the condenser is warm. Leak test the high-side system components.

SECTION E - Troubleshooting Chart

Complaint.	Cause-Remedy
<p>Compressor Will Not Run.</p>	<ol style="list-style-type: none"> 1. No voltage at wall receptacle - check circuit breaker or fuse. 2. Service cord pulled out of the wall receptacle - replace. 3. Low voltage causing compressor to cycle on overload. (Voltage fluctuation should not exceed 10% plus or minus from normal rating.) 4. Control thermostat dial in "Off" position - turn control on. 5. Inoperative control thermostat - replaced control. 6. Compressor stuck - replaced compressor. 7. Compressor windings open - replace compressor. 8. Defrost timer stuck in defrost - replace defrost timer. 9. Compressor overload open - replace overload. 10. Relay lead loose - repair or replace Lead. 11. Relay leads or inoperative - replace relay. 12. Service cord pulled out of harness - repair connection. 13. Faulty cabinet wiring - repair wiring.
<p>Compressor Runs, but No Refrigeration.</p>	<ol style="list-style-type: none"> 1. System out of refrigerant - check for leaks. 2. Compressor not pumping - replaced compressor. 3. Restricted filter-drier - replace filter-drier. 4. Restricted capillary tube - replace. 5. Moisture in the system - check for leaks in low side.
<p>Compressor Short Cycles.</p>	<ol style="list-style-type: none"> 1. Erratic control thermostat - replace control. 2. Faulty relay - replace relay. 3. Restricted airflow over condenser - insurer condenser has unobstructed airflow. 4. Low voltage - fluctuation exceeds 10%. (Call qualified electrician.) 5. Compressor draws excessive wattage - replaced compressor

Complaint.	Clause-Remedy
<p>Compressor Runs Too Much or 100%.</p>	<ol style="list-style-type: none"> 1. Erratic control thermostat, or setting too cold - replace are reset to normal position. 2. Freezer exposed to unusual heat - relocate freezer. 3. Abnormally high room temperature - advised customer. 4. Low pumping capacity compressor - replaced compressor. 5. Lid gasket not ceiling - adjust or replace necessary parts. 6. System undercharged - check for leaks. 8. Interior light stays on - check lid switch. 9. Non-condensables in system - replaced filter drier, evacuate, and recharge. 10. Capillary tube kinked or partially restricted - replace heat exchanger. 11. Filter drier, partially restricted - replace filter drier. 12. Excessive service load - advise customer. 13. Restricted airflow over condenser - ensure condenser has unobstructed airflow.
<p>Noisy.</p>	<ol style="list-style-type: none"> 1. Tubing vibrates - adjust tubing. 2. Internal compressor noise - replaced compressor. 3. Compressor vibrating on cabinet frame - just compressor. 4. Loose parts - check shelving, kick plate, and defrost drain pan. 5. Compressor operating at high head pressure due to restricted airflow around freezer - ensure freezer is installed properly.

Complaint.	Clause-Remedy
<p>Freezer Too Warm.</p>	<ol style="list-style-type: none"> 1. Inoperative fan motor - check wiring and fan motor. 2. Improperly positioned fan blade - position blade at end of shaft. 3. Evaporator iced up - check defrost system. 4. Defrost heater in operative - check wiring and defrost heater. 5. In operative defrost thermostat - checked wiring and defrost thermostat. 7. Wire loose at defrost timer - repair wire. 8. Excessive service load - advised customer. 9. Freezer lid left open - advise customer. 10. Controlled thermostat out of calibration - replace control. 11. Lid gasket not sealing - adjust or replaced necessary parts. 12. Control thermostats sensing element improperly positioned - reposition sensing element. 13. Shortage of refrigerant - check for leaks. 14. Restricted filter drier or capillary tube - check for leaks or burned compressor windings.
<p>Evaporate or Blocked With Ice.</p>	<ol style="list-style-type: none"> 1. Inoperative defrost timer- check wiring and defrost timer. 2. Defrost thermostat terminates too early - check for correct position of defrost thermostat or replace. 3. Defrost timer incorrectly wired - check wiring. 4. Inoperative fan motor - check wiring and fan motor. 5. Inoperative defrost thermostat - checked wiring and defrost thermostat. 6. Inoperative defrost heater - checked wiring and defrost heater. 7. Freezer lid left open - advise customer. 8. Freezer defrost drain plug - clean defrost port.

SECTION F - TEARDOWN

This section will describe how to remove components from the freezer. Unless stated, reverse the procedure to reinstall the component.

⚠ WARNING Always remove electrical power from the freezer when working in an area where electrical power is present.

Removing Interior Light Shield:

1. Raise the lid and using a small common screwdriver release the tab on either end and lift the cover off.

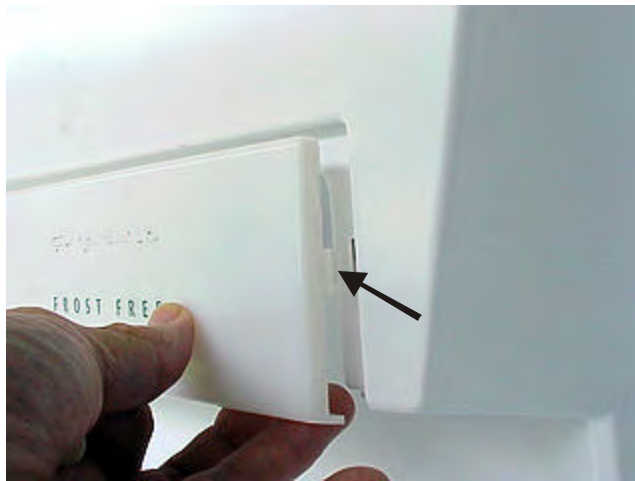

Removing Interior Light Bulb:

1. Raise the lid, remove the light shield and unscrew the light bulb.



Removing Interior Light Socket:

1. Disconnect electrical power from the freezer.
2. Raise the lid, remove the light shield and light bulb.
3. Use a small common screwdriver to release the tabs on the sides of the socket and pull the socket out of the inner liner.
4. Disconnect the two wires from the socket. When reconnecting the wires be sure to connect the white wire to the terminal marked W.



Removing Interior Light Switch:

1. Disconnect electrical power from the freezer and raise the lid.
2. Use a small common screwdriver to release the tab on the left side of the switch and pull the switch out of the inner liner.
3. Disconnect the two wires from the switch.

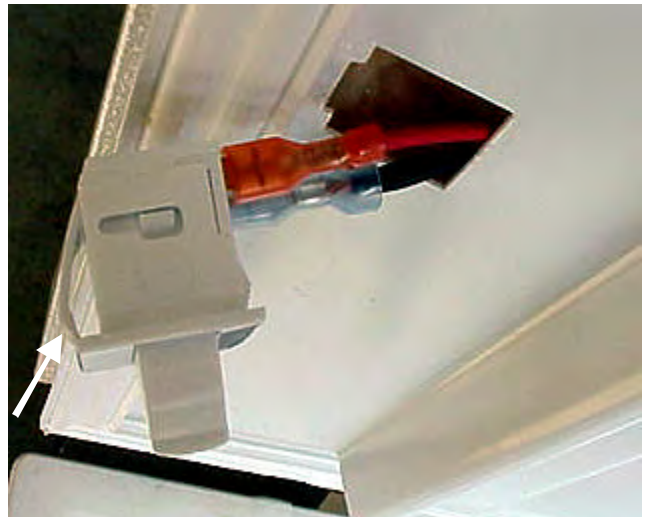

Removing Lid Inner Liner and Seal:

The lid inner liner is held to the lid cover by (36) plastic rivets and (4) Phillips head screws that are hidden in by the seal.

1. Disconnect electrical power from the freezer and raise the lid.
2. Remove the light switch and light socket.
3. Roll the seal back and using a common screwdriver pop-out the (36) rivets.



4. Remove the (4) Philips head screws holding the liner to the lid, lift the inner liner off, and carefully lay liner down on the smooth surface.

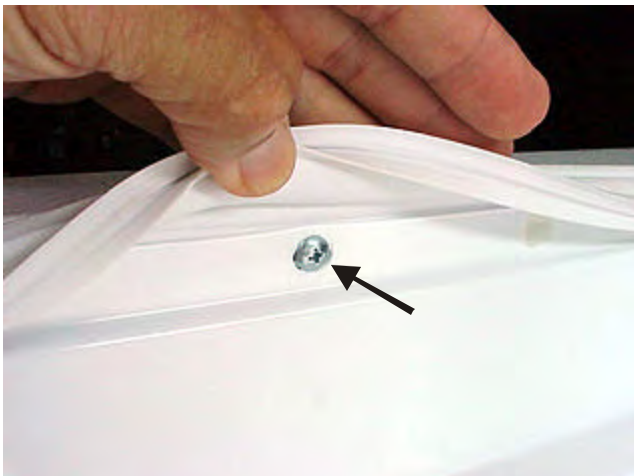

5. Remove the seal by starting in the corner and lifting the seal off.



Removing Lid Handle:

1. Disconnect electrical power from the freezer and remove the inner lid liner.
2. Pull the insulation back and remove the (2) nuts holding the handle to the outer liner of the lid.



3. Pull out on the front edge of the handle to disengage from the locking mechanism and lift to handle off.



Removing Lock Mechanism:

1. Disconnect electrical power from the freezer, remove the inner lid liner and the lid handle.
2. Remove the spring-loaded metal clip that holds a lock mechanism to the outer lid liner.



3. Remove the Phillips head screw holding the latch arm and remove the latch arm.



4. With the latch are removed slide that lock mechanism up the front of the panel.

Removing Power On Lamp:

1. Disconnect electrical power from the freezer, remove the inner lid liner and the lid handle.

2. Disconnect the (2) wires from the lamp. Squeeze the tabs on the side of the lamp housing and push the housing out through the panel.



Removing the Machine Compartment Cover:

1. Remove the (2) Phillips head screws holding the cover to the side of the freezer.



2. Lift up and out on the cover to disengage the (2) tabs at the bottom of the cover and lift the cover off.



Removing the Hinges:

1. While holding in on the bottom part of the hinge remove the (4) screws holding the bottom part of the hinge to the freezer.



2. Slowly release the pressure from the bottom part of the hinge.
3. While holding the hinge, remove the (4) screws holding the hinge to the lid.

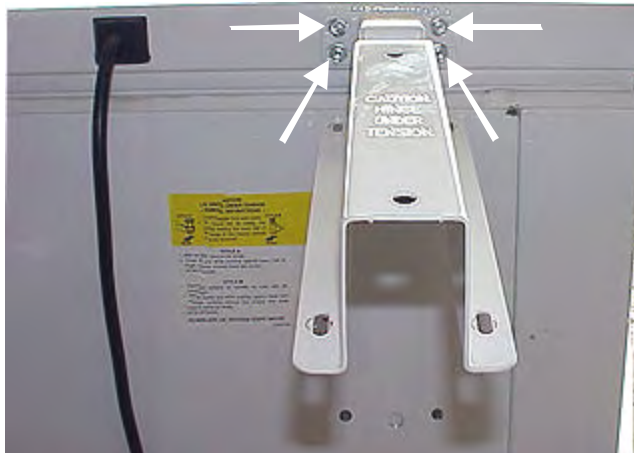

Removing the Hinges:(Alternate Method)

1. With the lid closed insert a pin or nail into the hinge to lock it closed.

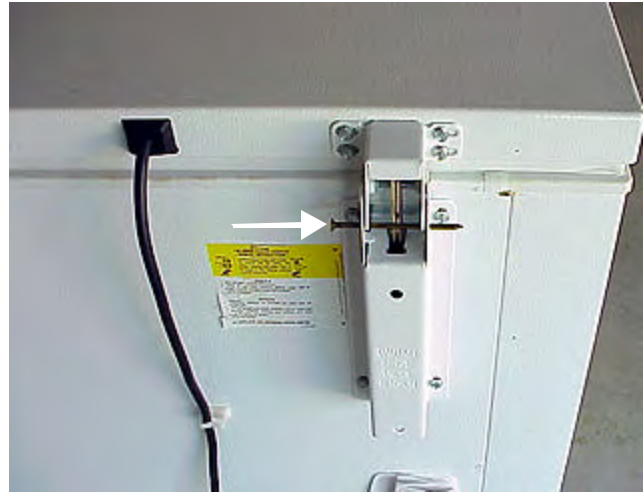

2. Remove the (4) screws holding the hinge to the lid and the (4) screws holding the hinge to the chassis.

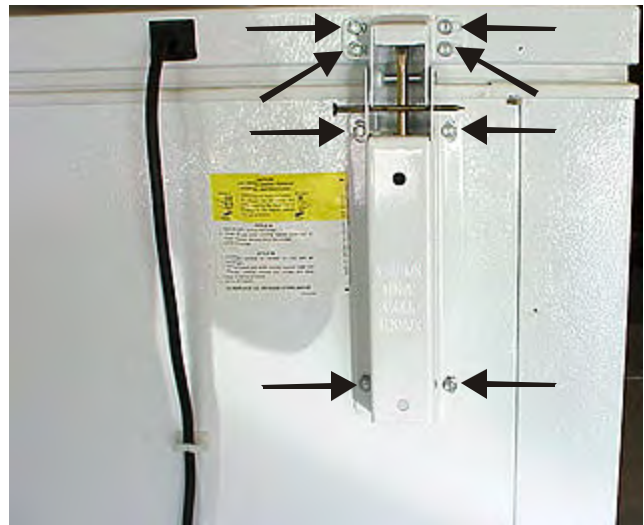

Removing Lid:

1. Disconnect electrical power from the freezer and remove the machine compartment cover.

2. Unplug the wiring harness going to the lid.



3. Remove the hinges, lift the lid off and place it on a clean flat surface.

Removing the Lid's Outer Panel:

1. Disconnect electrical power from the freezer and using a common screwdriver push the wiring harness grommet into the lid.



2. Remove the lid and place it on a clean and smooth surface.
3. Remove that inner liner, wiring harness, insulation, handle, locking mechanism and power on light.

Removing the Food Baskets:

1. The food baskets lift out of the freezer compartment.



Removing the Lower Basket Rails:

1. Remove the food baskets.
2. Remove the (6) Phillips head screws holding the rail to the freezer liner.

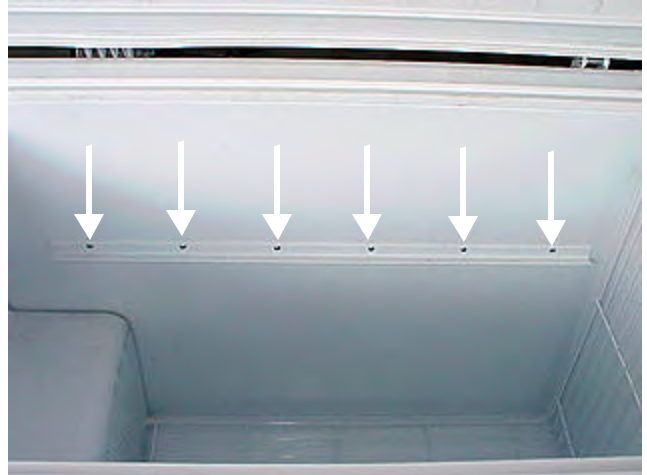

Removing the Wire Shelf:

1. Remove the food baskets.

- Disengage the two wire tips from the holes in the right side of the food liner.



- To lift up on the end of the rack to disengage the wire tip's from the bottom of the evaporator cover and pull out.



Removing the Cold Control Knob:

- Using a small common screwdriver, pop the knob off the shaft.



Removing the Cold Control and Fan Housing Cover:

- Using a small common screwdriver, open the (2) screw covers, one on each side.



- Remove the (2) Philips head screws holding the housing to the evaporator cover and slide the housing forward to remove.

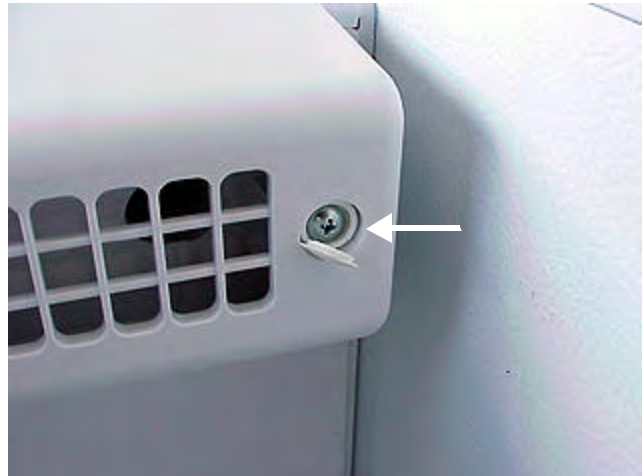

Removing the Cold Control:

- Disconnect power from the freezer and remove the cold control and fan housing cover.

2. Remove the Philips head screw holding the cold control bulb to the fan mounting bracket.



3. Remove the cold control bulb from the brackets on the evaporator cover.

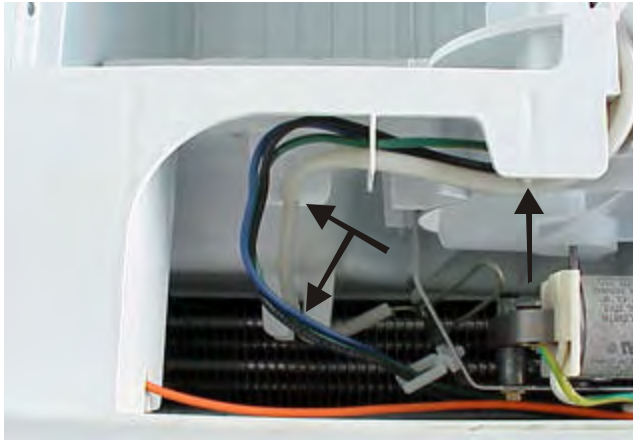

4. Remove the tape holding the cold control to the control housing.

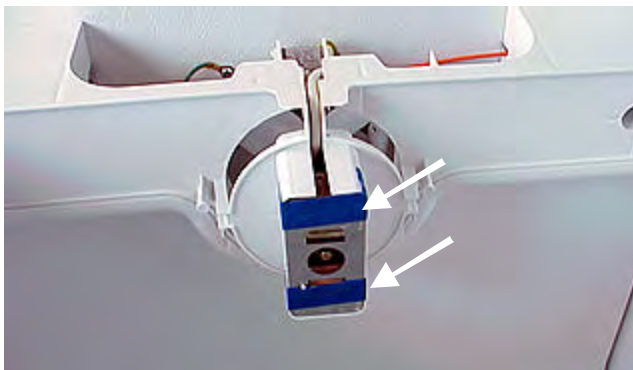

4. Pull the control forward and disconnect the (3) wires.

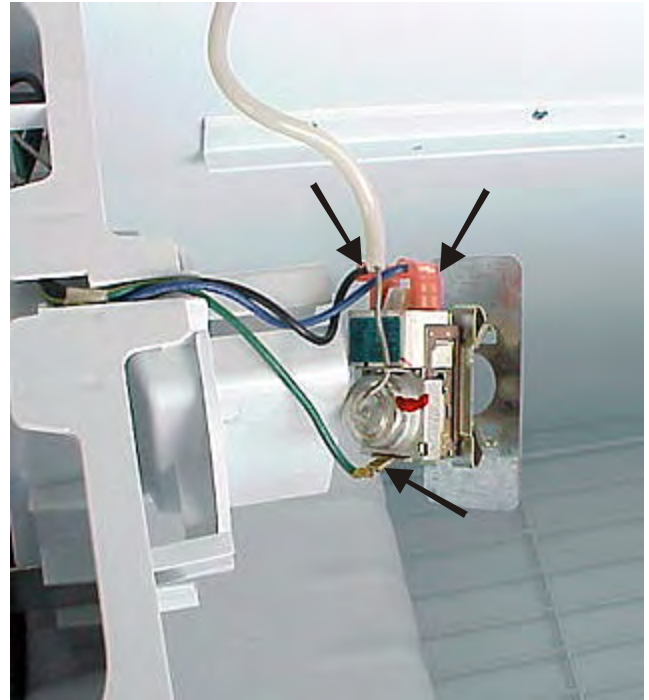

Releasing the Top of the Evaporator Cover:

1. Disconnect power from the freezer and remove the cold control and fan housing cover.
2. Remove the (2) 1/4" hex head screws, one on each end, holding the cover to the freezer liner.



3. Before refastening the evaporator cover make sure the wire plug in the bottom of the freezer is in place.

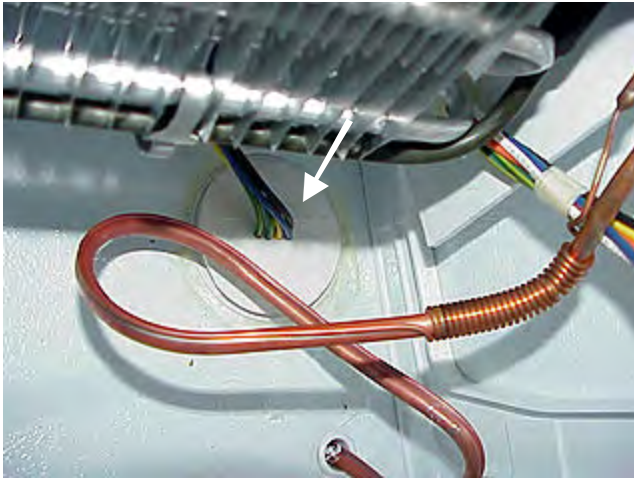

2. Disconnect the fan assembly wiring harness.

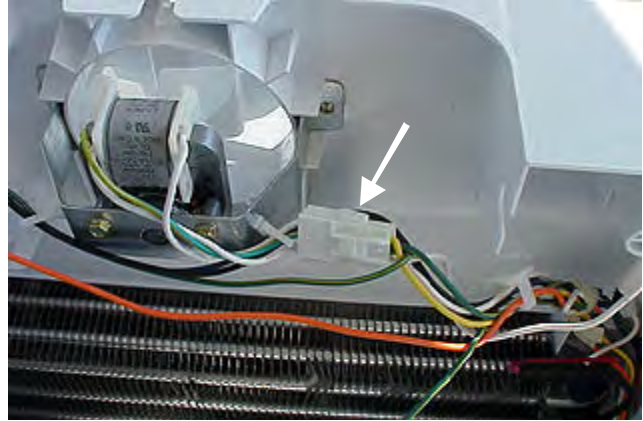

4. Tip the cover forward, and remove the green ground wire from the freezer liner.

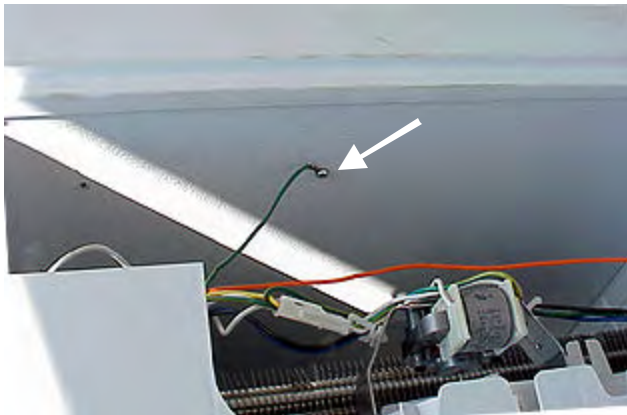

3. Using a 5/16" socket remove the (2) bolts holding the fan assembly to the fan mounting bracket and lift the fan assembly out.

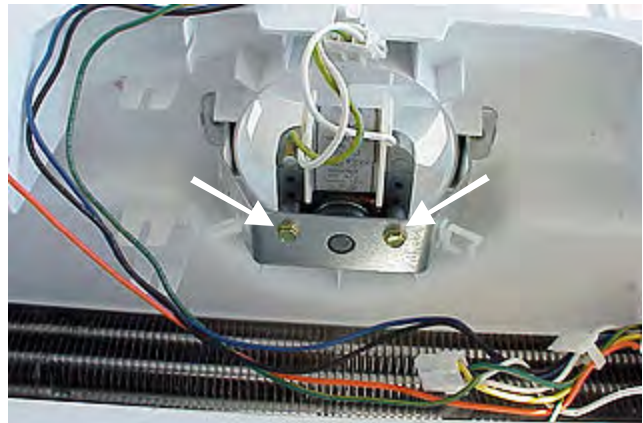

Removing the Evaporator Fan Assembly:

1. Disconnect power from the freezer, remove the cold control and fan housing cover and release the top of the evaporator cover.

Removing the Evaporator Fan Blade:

1. Disconnect power from the freezer and remove the evaporator fan assembly.
2. Pull the fan blade off with a shaft of the fan.

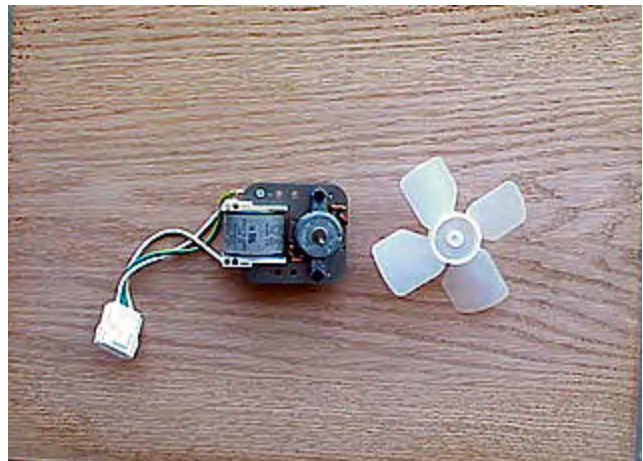

Removing the Evaporator Fan Mounting Bracket:

1. Disconnect power from the freezer, remove the cold control and fan housing cover and release the top of the evaporator cover.
2. Disconnect the fan assembly wiring harness and remove the cold control bulb from the bracket.
3. Remove the (2) Philips head screws holding the bracket to the evaporator cover.

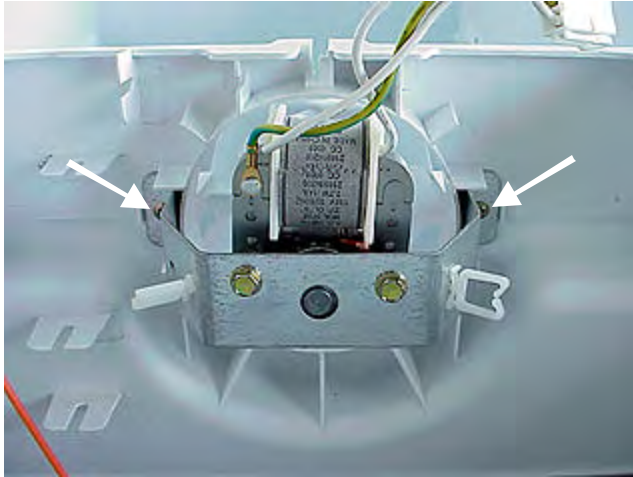

3. Unsnap the defrost termination thermostat from the evaporator to tubing.



Removing the Defrost Heater:

1. Disconnect power from the freezer, remove the cold control and fan housing cover and release the top of the evaporator cover.
2. Disconnect the (2) wires, one on each end, from the defrost heater.



Removing the Defrost Termination Thermostat:

1. Disconnect power from the freezer, remove the cold control and fan housing cover and release the top of the evaporator cover.
2. Disconnect the (2) wires from the defrost termination thermostat.

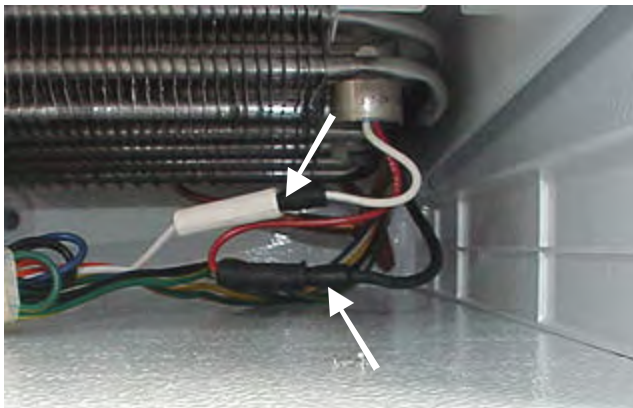

3. Remove the two metal straps holding the defrost heater to the bottom of the evaporator, and pull down on the heater.

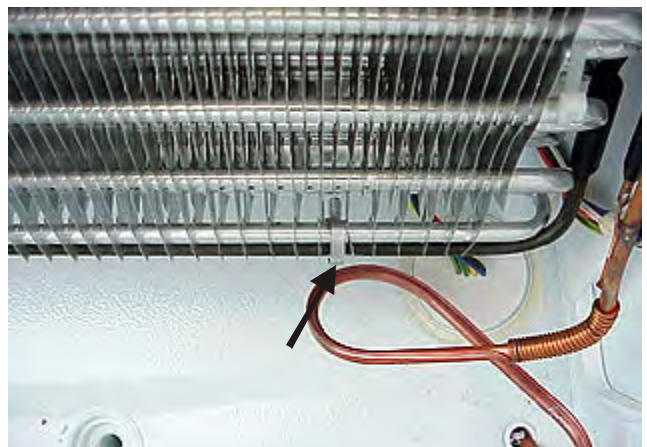

Removing the Evaporator Cover:

1. Disconnect power from the freezer, remove the cold control and fan housing cover and release the top of the evaporator cover.
2. Remove the cold control, disconnect the fan mounting bracket and release any wire clips from the cover.
3. Remove the two plastic straps, one on each end, holding the evaporator to the cover and lift the cover off.



Removing the Drain Pan:

1. Disconnect power from the freezer and remove the machine compartment cover.
2. The drain pan is mounted to the top of the compressor and is held in place by a plastic tab through a slot in the compressor housing.
3. To remove the drain pan, pull out.

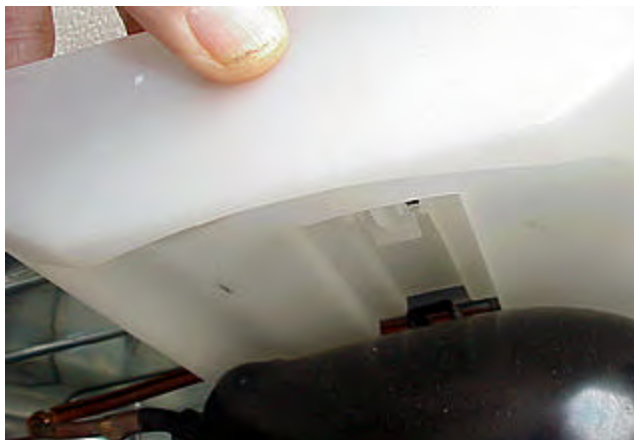

Removing the Filter-Drier:

1. Disconnect power from the freezer and remove the machine compartment cover.

CAUTION: On R-134a systems, the system must NOT be left open to the atmosphere for more than 10 minutes to prevent moisture contamination of compressor oil.

2. Recover refrigerant by using EPA approved recovery system.

CAUTION: DO NOT un-braze old filter-drier from system. This will vaporize and drive moisture from desiccant back into system. The old filter-drier should be cut out of system.

3. Using a three corner file score and break the tube at the bottom of the filter-drier.



4. Remove the filter-drier by cutting the tube at the top of the filter-drier as close as possible.



5. Evacuate and charge system using recommended procedure described under Evacuating and Recharging.

Removing the Evaporator:

1. Disconnect power from the freezer, remove the cold control and fan housing cover and release the top of the evaporator cover.
2. Remove the defrost heater, termination thermostat and the plastic straps holding evaporator to the evaporator cover.
3. Remove the machine compartment cover.
4. Recover refrigerant by using EPA approved recovery system.

Note: Whenever this sealed system is opened, the filter-drier must be replaced.

CAUTION: On R-134a systems, the system must NOT be left open to the atmosphere for more than 10 minutes to prevent moisture contamination of compressor oil.

5. Remove the filter-drier.
6. Cut the suction line at the compressor.

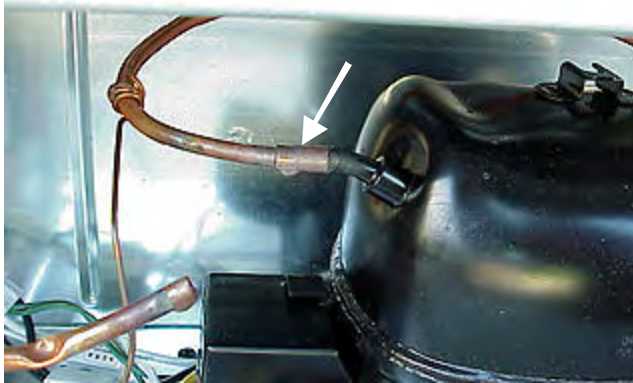

7. Straighten the tubing and carefully feed the heat exchanger, up through the cabinet, while lifting up on evaporator.

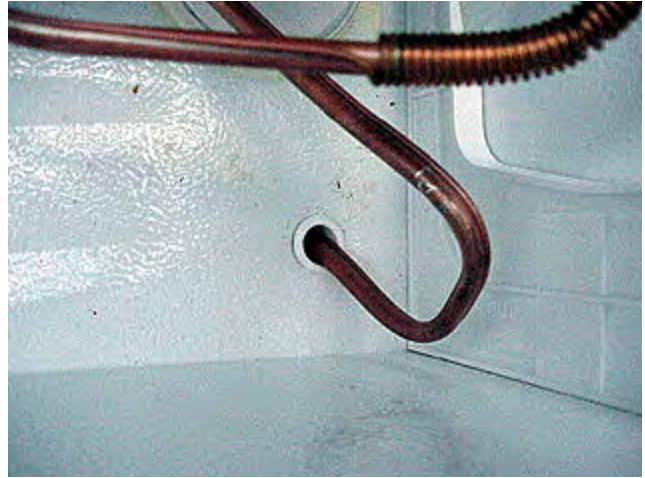

8. With the evaporator and heat exchanger removed from the freezer, remove the heat exchanger from the evaporator.

Replacing the Compressor:

CAUTION: NEVER install a new compressor without first checking for possible system contamination.

To check for contamination, obtain oil sample from old compressor.

- If the oil has burned odor, but no color change or residue — install the new compressor
- If oil has a burned odor and a sugar or gritty feel as well as showing signs of contamination (dark color) — Flush The System. Remove as much of contamination as possible from system before installing new compressor and filter-drier.

To Flush the System:

NOTE: It is recommended that system be flushed with dry Nitrogen. However, if refrigerant is used to flush the system you must look at the serial plate to see what type of refrigerant is used in the system. This is the only refrigerant that can be used to flush the system and it must be recovered.

CAUTION: Use extreme care when using Dry Nitrogen to flush systems. Pressure in

nitrogen cylinder could be as high as 2000 psi Nitrogen cylinder must be equipped with approved pressure regulator and pressure relief valve. Ensure that your hoses have adequate ratings for pressure involved and that all of your equipment is in good condition.

CAUTION: The end of the flushing hose on this tank regulator must be equipped with a hand shut-off valve (Robinair No. 4038 Close hand shut-off valve and adjust nitrogen regulator to correct pressure before proceeding with flushing procedure.

Using Dry Nitrogen to Flush the System:

1. Remove compressor and filter-drier. Connect process coupling to outlet tube of condenser.
2. Fasten cloth over other end of coil to prevent old oil from spraying over room.
3. Connect hand shut-off valve on flushing hose to process coupling.
4. Slowly open hand shut-off valve and allow nitrogen to flow through condenser until discharge is clear.

CAUTION: DO NOT exceed 300 PSIG.

5. Disconnect cap tube from evaporator. Flush evaporator in same manner as condenser.

CAUTION: DO NOT exceed 150 PSIG.

6. Flush cap tube. This is only possible if you have proper service valve adaptor.

CAUTION: DO NOT exceed 300 PSIG.

7. Reassemble system.

Using Refrigerant to Flush the System:

CAUTION: Refrigerant used for flushing must be recovered into a recovery system. Meter amount of refrigerant used for flushing with your charging cylinder. DO NOT OVERFILL THE SYSTEM.

1. Disconnect the suction and discharge lines from the compressor and remove the filter-drier. Connect process coupling to outlet and inlet tube of condenser.

2. Connect hose to outlet process coupling and charging cylinder. Connect another hose to inlet coupling and recovery system.
3. Open charging cylinder and allow refrigerant to flow through condenser until discharge into bag is clear.

NOTE: To flush evaporator and heat exchanger you must remove evaporator from inside product to disconnect cap tube.

4. Disconnect capillary tube from evaporator. Flush evaporator in same manner as condenser.
5. Flush cap tube. This is only possible if you have proper service valve adaptor.
6. Reassemble system.

Installing a New Compressor:

NOTE: Entirely new compressors have been developed for use with R-134a and Ester oil refrigeration systems. Both compressor and electric motor have been modified. Old compressors intended for R-12 refrigerant must not be used for new systems charged with R-134a.

Replacement of compressor and installation of filter-drier must be done in a continuous sequence so system is exposed to atmosphere no longer than necessary.

All replacement compressors are shipped with rubber plugs in the suction, discharge and process tubes and contain the correct oil charge and a holding charge of inert gas.

Compressors have a low-side process tube attached to the compressor shell. A high-side process tube is attached to the filter-drier.

WARNING: DO NOT OPERATE RECIPROCATING COMPRESSOR WHEN CHARGING LIQUID REFRIGERANT INTO SYSTEM THROUGH ITS PROCESS TUBE.

Replacement compressors for refrigerator may have an oil cooler even if the original compressor did not. If the product is not equipped for an oil cooler, leave the plastic caps in place and install the compressor connecting only to the suction and discharge lines of the new compressor.

Before installing the replacement compressor remove the discharge plug and check for the pop sound of the inert gas leaving the compressor.

CAUTION: DO NOT use compressor if you do not hear this sound.

If the compressor checks OK, reinstall the plug. Do not remove any of the plugs again until the compressor is in position and you are ready to braze the lines.

CAUTION: On R-134a systems, compressor must NOT be left open to atmosphere for more than 10 minutes to prevent moisture contamination of oil.

A new compressor which is cold (e.g. after having been kept in a cold service van) should be left to warm to the surrounding temperature before the plugs on the compressor connections are removed. This will help prevent condensation from forming in the oil and the compressor. Also, avoid opening the system when any of the components or lines are cold.

NOTE: RELEASE holding charge (release slowly to avoid oil discharge) on new compressor to ensure there is no leak in seam or tubing. Reinstall rubber plug.

1. Disconnect electrical supply to refrigerator.
2. Remove machine compartment panel.
3. Recover refrigerant by using EPA approved recovery system.
4. Remove the cover from the start relay and overload.

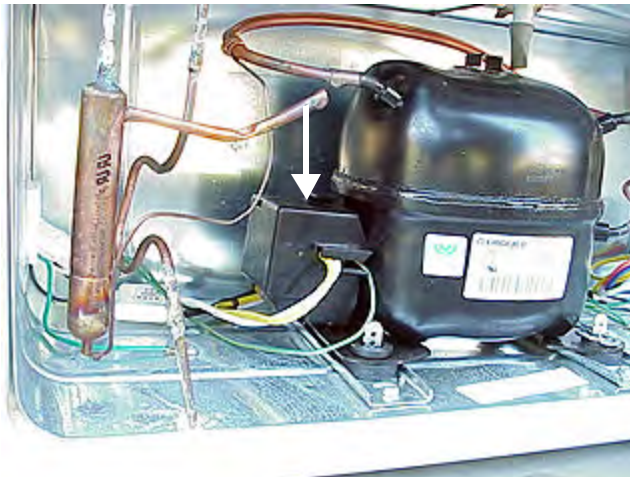

5. Remove the start relay, overload and disconnect the ground wire.

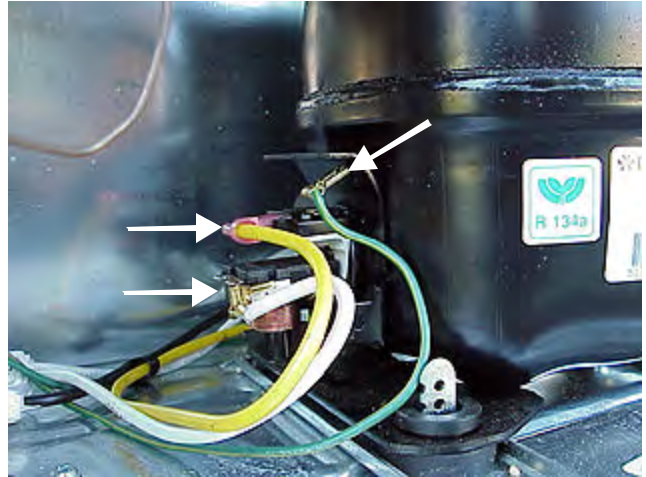

6. Remove mounting clips and washers.



7. After refrigerant is completely recovered, cut suction and discharge lines as close to compressor as possible. Leave only enough tubing to pinch off and seal defective compressor. Plug or tape any open system tubing to avoid entrance of moisture and air into system. Remove inoperable compressor and transfer mounting parts to new compressor.
8. Install new compressor in exact same manner as original compressor.
9. Reform both suction and discharge lines to align with new compressor. If they are too short, use additional lengths of tubing. Joints should overlap 0.5" to provide sufficient area for good solder joint. Clean and mark area where tubing should be cut. Cut tubing with tubing cutter. Work as quickly as possible to avoid letting moisture and air into system.

NOTE: If low-side process tube is too short, silver solder four inch piece of tubing onto process tube at this time.

10. Solder all connections.

13. Replace the original filter-drier.

CAUTION: DO NOT un-braze old filter-drier from system. This will vaporize and drive moisture from desiccant back into system. The old filter-drier should be cut out of system.

15. Evacuate and charge system using recommended procedure described under Evacuating and Recharging.

Removing the Defrost Timer:

1. Disconnect power from the freezer and remove the machine compartment cover.
2. Disconnect the wiring harness from the defrost timer.

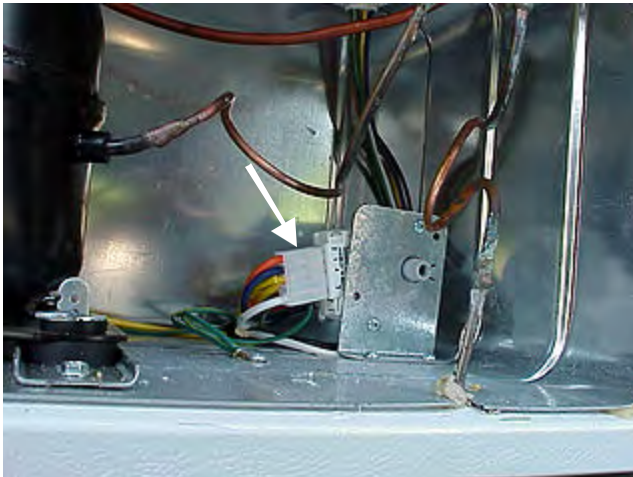

3. Remove the (2) Phillips head screws holding the timer to the timer mounting bracket and slide the timer out the back.

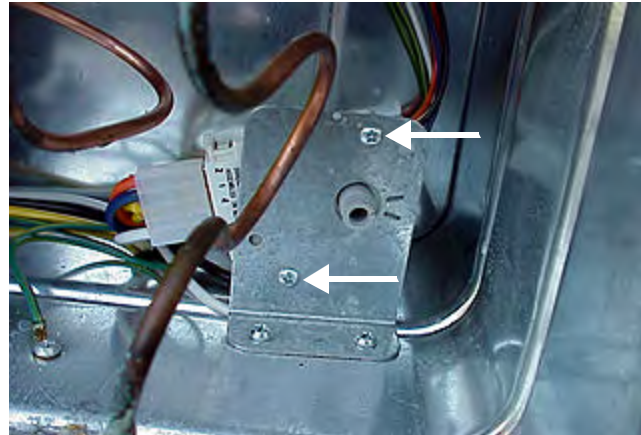

Replacing the Condenser:

The condenser is foamed in place and is not accessible for repair. However, repair can be made by installing a service replacement condenser kit. Refer to the appropriate part list of the model been service for the correct kit part number.

Each service replacement condenser kit consists of: a condenser assembly that can be installed on the back of the Cabinet, mounting hardware, replacement filter-drier and a complete installation instructions.

To install, use the following procedure:

1. Disconnect unit from source of power.
2. Recover refrigerant by using EPA approved recovery system.
3. Installed the replacement condenser in accordance with the instructions included with the kit.
4. Evacuate and charge a system using the recommended procedure described under evacuation and recharging found in section D.

Replacing the Breaker Collar Trim:

When the freezer is manufactured, the trim and end caps are installed before foam is added to the freezer. When foam is added to the freezer, some of the foam adheres to the trim and caps, helping to hold them in place. When a piece of trim or cap is removed, some of the foam will come with it. If the trim or end cap is to be reused the foam must be cleaned off.

The outer liner of the freezer has a 3/16" flange and the inner liner has (2) grooves in it.

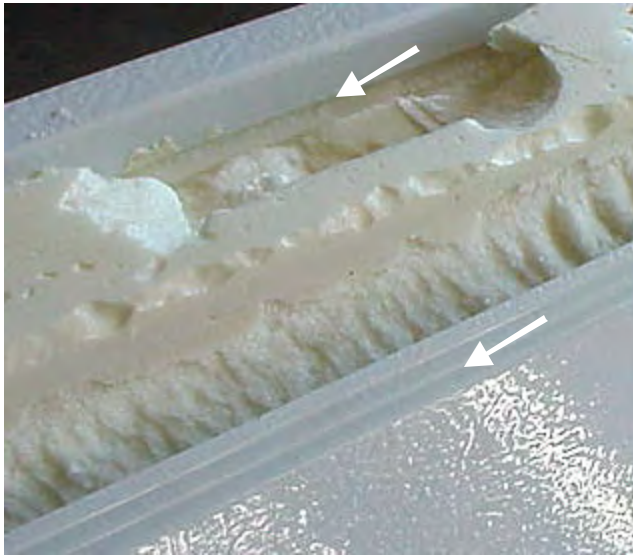

The trim has a channel with a locking tab that snaps down over the inner liner and a flange with a locking tab that snaps under the flange of the outside liner.

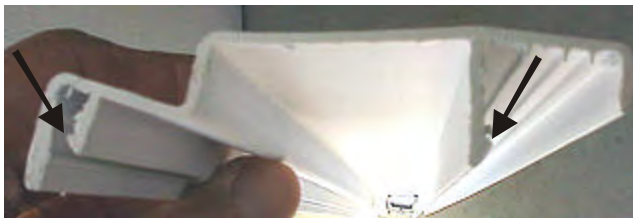

The end caps are formed to allow the trim to slide into them.

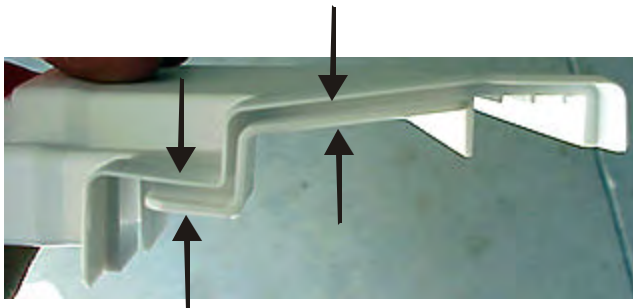

Removing the Trim:

1. Lift the freezer lid and starting at the inside center, lift up and out on the trim to disengage it from the inside liner. Then pull up and out on the trim to disengage it from the foam, and the flange of the outer freezer liner.



2. Once the trim has been disengaged from the liners and the foam, bow the center of the trim up to disengage from the end cap.

To Remove the End Caps:

1. Lift the lid and remove one of the pieces of trim connect to the end cap.
2. Lift up on the front edge of the end cap, that is in line with the remaining piece of trim, and slide it off.



