



ELECTROLUX HOME PRODUCTS NORTH AMERICA

Service Manual

Built-in Side by Side Refrigerator



SAFE SERVICING PRACTICES - ALL APPLIANCES

To avoid personal injury and/or property damage, it is important that **Safe Servicing Practices** be observed. The following are some limited examples of safe practices:

1. **DO NOT** attempt a product repair if you have any doubts as to your ability to complete it in a safe and satisfactory manner.
2. Before servicing or moving an appliance:
 - Remove the power cord from the electrical outlet, trip the circuit breaker to the OFF position, or remove the fuse.
 - Turn off the gas supply.
 - Turn off the water supply.
3. Never interfere with the proper operation of any safety device.
4. **USE ONLY REPLACEMENT PARTS CATALOGED FOR THIS APPLIANCE. SUBSTITUTIONS MAY DEFEAT COMPLIANCE WITH SAFETY STANDARDS SET FOR HOME APPLIANCES.**
5. **GROUNDING:** The standard color coding for safety ground wires is **GREEN**, or **GREEN** with **YELLOW STRIPES**. Ground leads are not to be used as current carrying conductors. It is **EXTREMELY** important that the service technician reestablish all safety grounds prior to completion of service. Failure to do so will create a hazard.
6. Prior to returning the product to service, ensure that:
 - All electrical connections are correct and secure
 - All electrical leads are properly dressed and secured away from sharp edges, high-temperature components, and moving parts
 - All non-insulated electrical terminals, connectors, heaters, etc. are adequately spaced away from all metal parts and panels
 - All safety grounds (both internal and external) are correctly and securely connected
 - All panels are properly and securely reassembled

ATTENTION!!!

This service manual is intended for use by persons having electrical and mechanical training and a level of knowledge of these subjects generally considered acceptable in the appliance repair trade. Electrolux Home Products cannot be responsible, nor assume any liability, for injury or damage of any kind arising from the use of this manual.

© 2001 White Consolidated Industries

Table of Contents

3-Way Valve	40
Auger Motor	32
Casters and Leveling	26
Components	23
Component Locator Views	12
Component Resistance Values	8
Compressor	39
Control Features	10
Cube Motor and Cube Reed Switch	32
Defrost Cycles	43
Diagnostic Mode	54
Dispenser Control Panel	34
Dispenser Heater	37
Dispenser Switch	37
Doors	23
Door Closer Assembly	25
Door Switches	41
Door Water Line Replacement	38
Drain Pan	26
Drier	40
Duct Door Assembly	36
Evacuation and Charging Procedure	16
Fans	44
Freezer Evaporator Assembly	46
Freezer Evaporator Components	49
Freezer Heater Testing	46
Fresh Food Evaporator Assembly	50
Fresh Food Evaporator Components	52
Fresh Food Heater Testing	50
Heat Exchanger	39
Icemaker Controls	11
Icemaker Fill Tube and Heater	31
Ice Bin and Icemaker	31
Ice Dispenser	35
Installation Example 42" Model	5
Interior Airflow	17
Interior Lights	42
Introduction	4
Machine Compartment Access Door	23
Main Switch	34
Mufflers	39
Nomenclature	9
Power Control Board (PCB)	27
Refrigerant Flow	14
Refrigeration Components	13
Refrigeration System	13
Replacing the Freezer or Fresh Food Evaporator	52
Schematics	58
Service Diagnostics	54
Technical Data	8
Terminal Block Panel	29
Thermistors	42
Troubleshooting Notes	57
Water Valve and Water Tank	35

INTRODUCTION

The new Profile Built-In Side by Side refrigerator has the following features:

- Separate freezer and fresh food evaporators are recessed into the machine compartment for increased efficiency and interior space savings.
- 3-Way valve directs refrigerant flow where needed.
- High-and low-side sealed system mufflers quiet the operation.
- Inverter is built into the power control board (PCB).
- Combined dispenser and temperature control board provides customer control and test mode operations.
- Dispenser cube motor and cam replaces solenoid-operated cube mechanism.
- Room ambient thermistor aids power control board (PCB) operation.
- Component electrical testing is performed at the machine compartment-mounted terminal block.
- Rear leveling mechanism is front-adjustable.



INSTALLATION EXAMPLE 42" MODEL

THE INSTALLATION SPACE

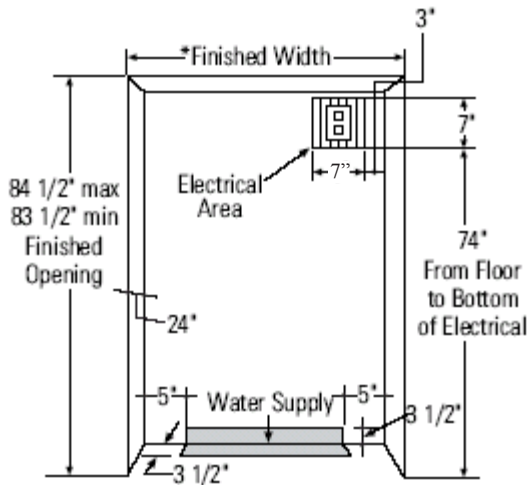

* The finished cutout width must be:
41-1/2" for 42" models

Water and Electrical Locations

The opening must be prepared with the electrical and water supply located as shown.

The cutout depth must be 24"

The refrigerator will project forward, slightly beyond adjacent cabinets, depending on your installation.

Additional Specifications

- A 120 volt, 60Hz, 15 or 20 amp power supply is required. An individual properly grounded branch circuit or circuit breaker is recommended. Install a properly grounded 3-prong electrical receptacle recessed into the back wall. Electrical must be located on rear wall as shown.

Note: GFI (ground fault interrupter) is not recommended.

- Water line can enter the opening through the floor or rear wall. The water line installed should be 1/4" O.D. copper tubing between the cold water line and water connection location. The line should be long enough to extend to the front of the refrigerator. Installation of an easily accessible shutoff valve in the water line is required.

Wood Panel 70 LB food door 30 LB freezer door

DIMENSIONS AND CLEARANCES

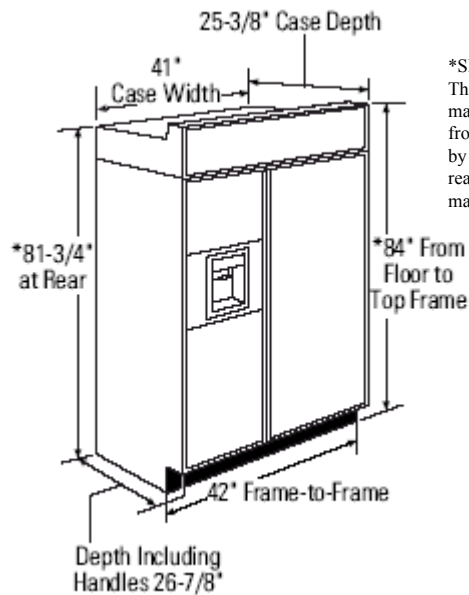

*Shipping height
The front height may be adjusted from 83-1/2" to 84-1/2" by adjusting front and rear leveling legs a maximum of 1".

Product Clearances

These refrigerators are equipped with a 2 position door stop. The factory set 130° door swing can be adjusted to 90° if clearance to adjacent cabinets or walls is restricted

130° Door Swing

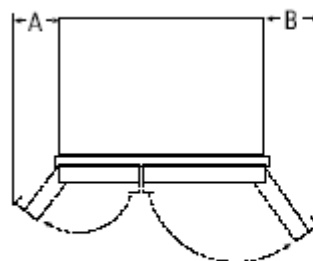

90° Door Swing

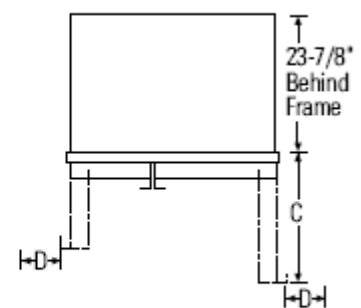

Models	A	B	C	D
42"	12-3/16"	16"	24"	4"

May Change with our handle

Allow minimum clearances for Freezer door (Dimension A) and Fresh Food door (Dimension B) for a full 130° door swing and to allow for drawer removal.

Four inch (4") minimum clearance is required when door swing is adjusted to 90°. If the 90° door stop position is used, drawer access is maintained, but drawer removal is restricted.

INSTALL ANTI-TIP BRACKETS

⚠ WARNING: ANTI-TIP PRECAUTIONS

The refrigerator is **Top-Heavy** and must be secured to prevent the possibility of tipping forward.

- Cut a 2" x 4" wood block 36" long, and secure the block to the mounting brackets provided, using #12 or #14 wood screws.
- Secure the brackets with wood block to the back wall so that it is 82" (or the rear installation height) from the finished floor. Use #12 or #14 wood screws.
- Screws must penetrate at least 1" into vertical wall studs.

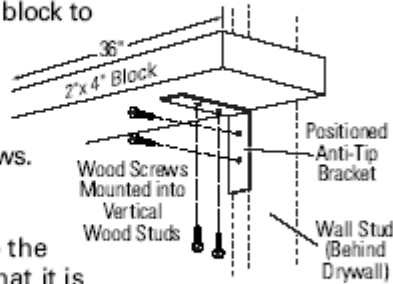

SECURE REFRIGERATOR TO CABINETS

Whenever possible, perform this step for anti-tip security.

The refrigerator must be secured to prevent tipping.

- Raise the grille panel to access case trim.
- Drive a screw through the trim and into the adjacent cabinet using holes provided.
- Follow the same procedure on the opposite side.

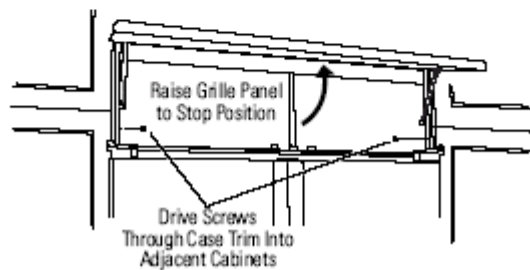

ALTERNATE ANTI-TIP PRECAUTIONS

SKIP THIS STEP WHEN USING ANTI-TIP BRACKETS

All Profile built-in refrigerators are **Top-Heavy**. They must be secured to prevent the possibility of tipping forward. Use this alternative method to secure the refrigerator whenever steel wall studs are encountered.

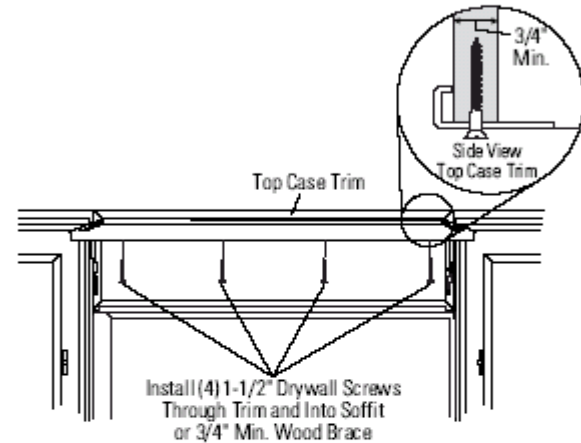

- Adjust height of refrigerator to match installation cutout opening 83-1/2" to 84-1/2". The refrigerator must be level and plumb with cabinets. The top case trim at the front is 2-1/8" higher than the rear and will overlap upper cabinets or cabinet trim.
- Open grille panel to access the top case trim.
- Use a 3/16" bit to drill 4 evenly spaced clearance holes through the metal top case trim.
- Use a 1/16" bit to drill pilot holes through the metal clearance holes and into wood soffit. The holes should be centered in the soffit or a 3/4" minimum wood brace. The brace spanning the enclosure must be securely fastened to cabinets on both sides.
- Install four 1-1/2" drywall screws into the pilot holes.

**CUSTOMIZATION BASICS:
Framed Or Custom Panels**

Stainless Steel Wrapped Models

42" wide model - PSB42LSRBV

Trimmed Models

42" wide models - PSB42LGRWV, PSB42LGRBV

Stainless Steel Wrapped Refrigerators

Stainless Steel wrapped refrigerators have wrapped doors and grille panels, and beveled edges. These models are shipped ready for installation.

Door Handles

The handles can be used to accommodate both framed or custom panels.

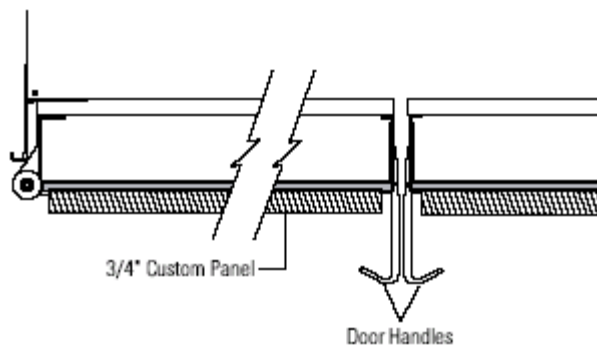

Trimmed Refrigerators

Trimmed refrigerators are designed to be customized with decorative panels. Field installed custom door and grille panels are required. You may install 1/4" thick custom panels from your cabinet manufacturer. The decorative panel slides into the factory installed trim. Or, order black and white accessory panels from your Profile dealer.

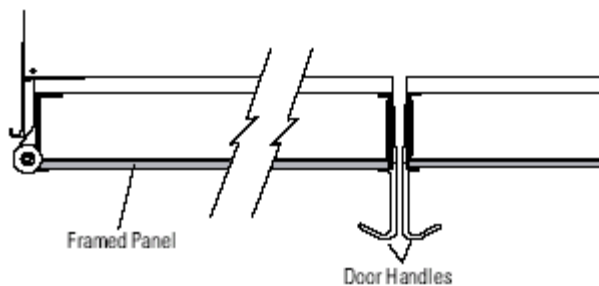

Side Panels

Side panels (not supplied) must be used whenever the sides of the refrigerator will be exposed.

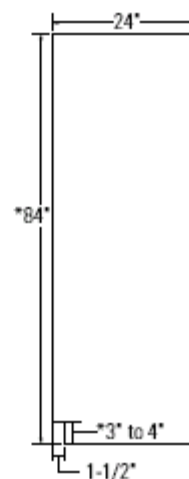

*Depending on installation height.

**DISCONNECT POWER CORD BEFORE SERVICING
IMPORTANT - RECONNECT ALL GROUNDING
DEVICES**

TECHNICAL DATA

All parts of this appliance capable of conducting electrical current are grounded. If grounding wires, screws, straps, clips, nuts or washers used to complete a path to ground are removed for service, they must be returned to their original position and properly fastened.

CAUTION

To avoid personal injury when servicing the condensing unit, stand on a ladder which will give enough support to allow removal of the top panel and safely allow access to service the unit.

ELECTRICAL SPECIFICATIONS

Max Defrost Control	
w/No Door Openings.....	16 hrs
Evap Defrost Thermistor.....	68°F (FZ)..63°F (FF)
Electrical Rating: 115V AC 60 HZ.....	5.4 amp
Maximum Current Leakage.....	0.75 mA
Maximum Ground Path Resistance.....	0.1 W
Energy Consumption Model 42.....	50.5 KWh/mo
Energy Consumption Model 48.....	53.75 KWh/mo

COMPONENT RESISTANCE VALUES

FF fan motor	1600 Ω! ± 20%
FZ fan motor	1600 Ω! ± 20%
Condenser fan motor	1600 Ω! ± 20%
Auger motor	3.7 Ω! ± 15%
Cube motor	2091 Ω! ± 10%
Cover motor	2091 Ω! ± 10%
Defrost heater FZ	44 Ω! ± 7%
Drain heater FZ	377 Ω! ± 7%
Sub-heater FZ	1322 Ω! ± 7%
Defrost heater FF	120 Ω! ± 7%
Drain heater FF	440 Ω! ± 7%
Fill-tube heater	2645 Ω! ± 7%
Dispenser heater (Recess).....	1889 Ω! ± 7%
Compressor (between the different phase)	11.7 Ω! ± 7% / 1 phase
3- way valve	40 ± 4 Ω! / 1 phase
Water valve (Ice maker)	180 Ω! ± 7%
Water valve (Dispenser)	325 Ω! ± 7%

IMPORTANT SAFETY NOTICE

This information is intended for use by individuals possessing adequate backgrounds of electrical, electronic and mechanical experience. Any attempt to repair a major appliance may result in personal injury and property damage. The manufacturer or seller cannot be responsible for the interpretation of this information, nor can it assume any liability in connection with its use.

NO LOAD PERFORMANCE

Control Position	37-0°F and
Ambient Temperature of:	70°F 90°F
Fresh Food °F	37-42 36-43
Frozen Food °F (-2)-2 (-2)-5	
Percent Running Time, %.....	35-45 65-75

REFRIGERATION DIAGNOSIS

To access the **low pressure** side of the system, install a line tap valve on the process tube extending from the compressor case.

REFRIGERATION SYSTEM

Refrigerant Charge (R134a).....	8.11 ounces
Compressor.....	738-1270 BTU/hr
Minimum Compressor Capacity	
Vacuum.....	26 inches
Minimum Equalized Pressure	
@70°F.....	66 PSIG
@90°F.....	74 PSIG

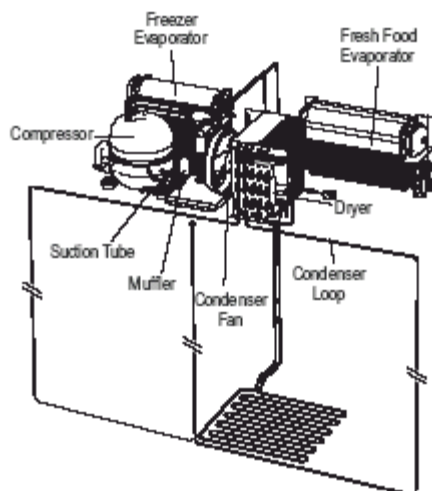

Icemaker Controls

MODEL AND SERIAL NUMBER INFORMATION

E42BS85EPS

THE PS IS FOR STAINLESS STEEL

E42BS75ETT

THE TT IS FOR MODEL WITH TRIM ON DOORS

Serial Plate Location



The Serial plate is located at the top of the fresh food section on the right-side wall. It contains the model and serial numbers and specifies the minimum

installation clearances, electrical voltage, frequency, maximum amperage rating, and refrigerant charge.

Mini-Manual

The mini-manual is located behind the grille panel at the top of the refrigerator. When service is completed, return the mini-manual to its original location for future use.

Serial Number

The first letter tells us where the product was made, the second letter tells us what type product it is. The first number is the year the product was made. The next two numbers are the week the product was made.

Example BA51400000,

B - Is the Anderson refrigerator factory.

A - Is a refrigerator

5 - Is 2005

14 - Is week 14

The rest of the numbers are the sequence number for week 14 of 2005.

Control Features

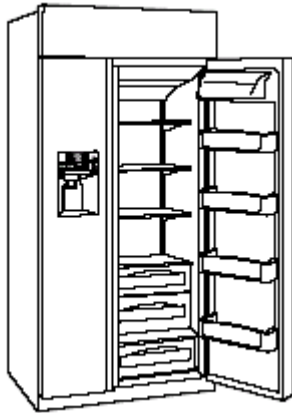
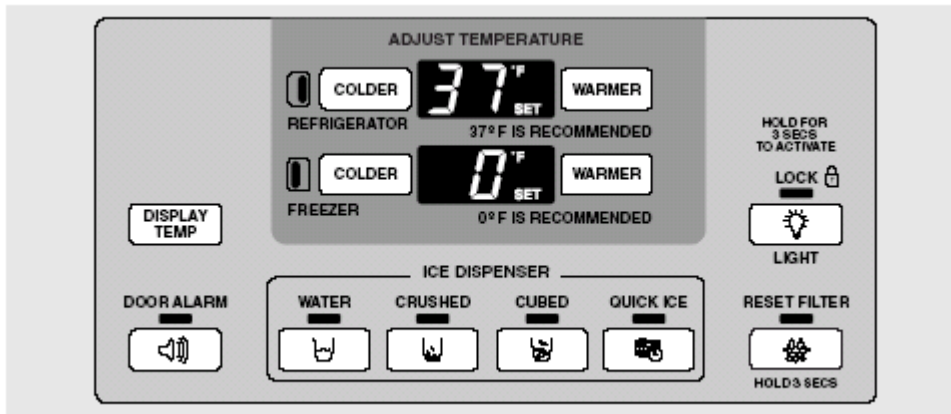

The temperature controls are preset in the factory at 37°F for the refrigerator compartment and 0°F for the freezer compartment. Allow 24 hours for the temperature to stabilize to the preset recommended settings.

The temperature controls can display both the **SET** temperature as well as the actual temperature in the refrigerator and freezer.

The actual temperature may vary slightly from the SET temperature based on usage and operating environment.

NOTE: The refrigerator is shipped with protective film covering the temperature controls. If this film was not removed during installation, remove it now.

To change the temperature, press and release the **WARMER** or **COLDER** button. **SET** will illuminate in the display, as well as the set temperature. To change the temperature, tap either the **WARMER** or **COLDER** button (while **SET** is illuminated) until the desired temperature is displayed. Refrigerator temperatures can be adjusted between 34°F and 47°F and the freezer temperatures can be adjusted between -6°F and +8°F.

Once the desired temperature has been set, the temperature display will clear after 10 seconds. To display the temperature, the **DISPLAY TEMP** button may be tapped. Several adjustments may be required. Each time you adjust controls, allow 24 hours for the refrigerator to reach the temperature you have set.

Icemaker Controls

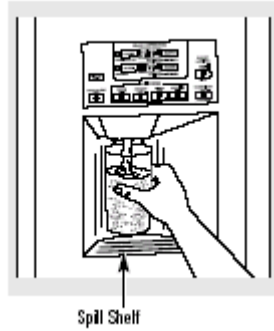

To Use the Dispenser

Select **CUBED**, **CRUSHED** or **WATER**. Press the glass gently against the middle of the dispenser pad. The spill shelf is not self-draining. To reduce water spotting, the shelf and its grille should be cleaned regularly.

If no water is dispensed when the refrigerator is first installed, there may be air in the water line system. Press the dispenser arm for at least two minutes to remove trapped air from the water line and to fill the water system. To flush out impurities in the water line, throw away the first six glassfuls of water.

CAUTION:

Never put fingers or any other objects into the ice crusher discharge opening.

Locking the Dispenser



Press the **LOCK/LIGHT** button for 3 seconds to lock the dispenser and control panel. To unlock, press and hold the button again for 3 seconds.

Display after power failure:

After a power failure, the display will reset based on freezer temperature. If the freezer temperature is below 40°F, the display will retain the settings prior to power loss. The chart at the right describes the possible settings.

Control Function	Freezer<40°F	Freezer>40°F
Refrigerator Set Temperature	Previous Setting	Default 37°F
Freezer Set Temperature	Previous Setting	Default (0°F)
Door Alarm	Previous Setting	Previous Setting
Dispenser Option	Previous Setting	Default (Crushed Ice)
Quick Ice	Previous Setting	OFF
Reset Filter	Previous Setting	Previous Setting
Lock	Previous Setting	Previous Setting
Dispenser Light	Previous Setting	OFF

Quick Ice



When you need ice in a hurry, press this button to speed up ice production. This will increase ice production for the following 48 hours or until you press the button again.

Dispenser Light



This button turns the **night light** on the dispenser on and off. The light also comes on when the dispenser pad is pressed. If this light burns out, it should be replaced with a 6 watt 12V maximum bulb.

Door Alarm



To turn the Door Alarm on, press the **DOOR ALARM** button once. The **ACTIVE** light will come on. To turn it off, press it again. When the **DOOR ALARM** is active, the **ACTIVE** light will flash if you open the door and beep if you keep the door open for more than 2 minutes. The light goes out and the beeping stops when you close the door. Spill Shelf

Note: When **QUICK ICE** is selected, the freezer temperature operates at -9°F for 48 hours or until **QUICK ICE** is pressed again. There is no change of temperature on the display panel. In the event of a power loss, if the freezer temperature is above 40°F, Quick Ice will not restart. Below 40°F, the refrigerator will return to the Quick Ice mode.

Component Locator Views

Machine Compartment

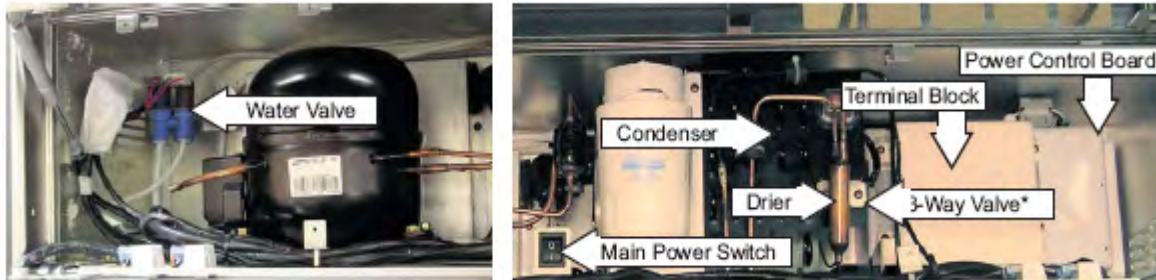

*The 3-way valve is located behind the condenser front plate.

Refrigerator (Bottom View, Drain Pan Removed)

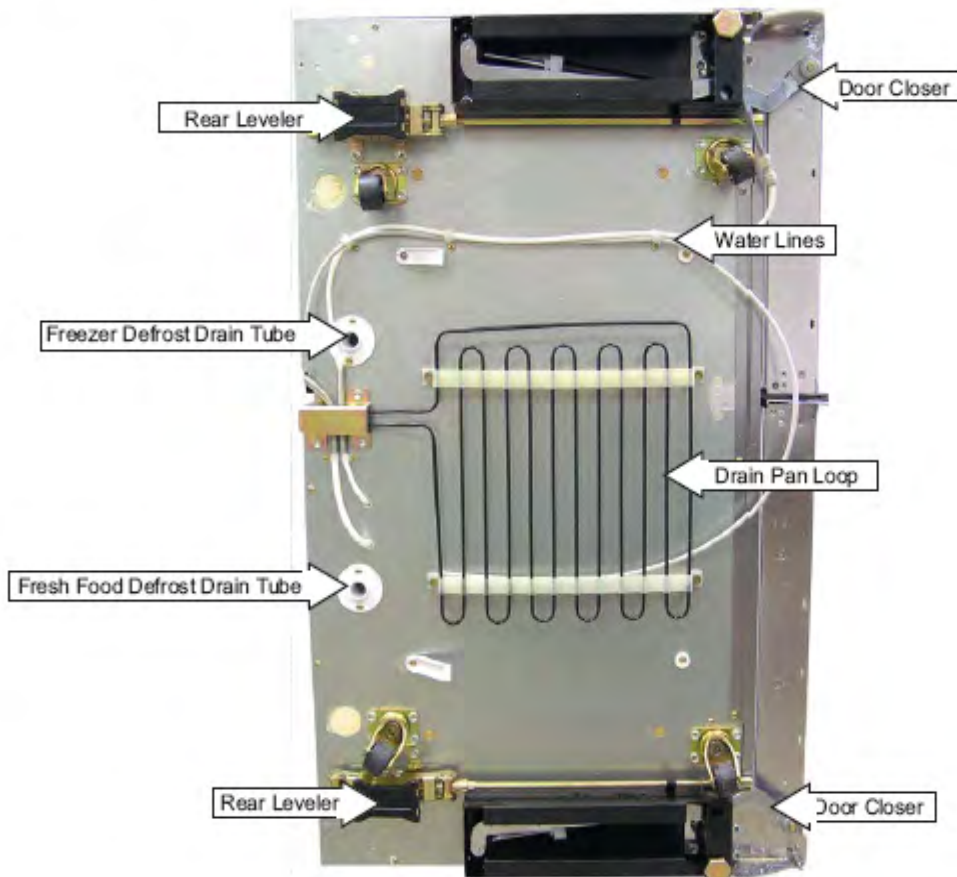

Refrigeration System

Refrigeration Components

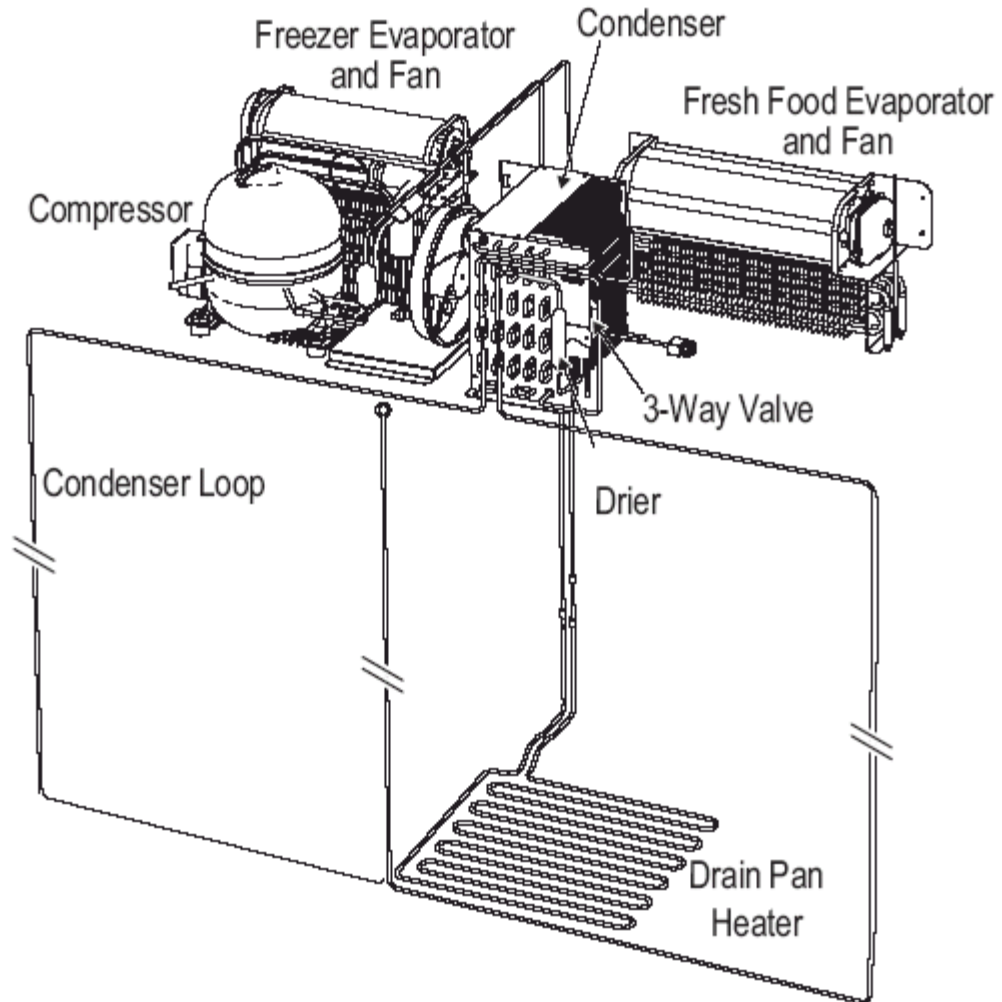

Refrigerant Flow

The compressor compresses R134a refrigerant, raising its pressure and temperature. Refrigerant vapor is pumped out the compressor discharge, down through the drain pan loop, up through the condenser coil, around the condenser loop, through the drier, and into the 3-way valve. By the time the refrigerant has reached the 3-way valve, it has completely condensed into a liquid. Depending upon whether the main control board opens the 3-way valve to the freezer evaporator

or the fresh food and freezer evaporators, refrigerant flows through the appropriate capillary tube and into the evaporator. As the high pressure liquid passes through the capillary and enters the low pressure evaporator, it quickly expands and evaporates. During evaporation, the refrigerant absorbs heat, becoming cold. At the outlet of the freezer evaporator, an accumulator captures any remaining liquid, allowing only low pressure vapor to return to the compressor through the suction line.

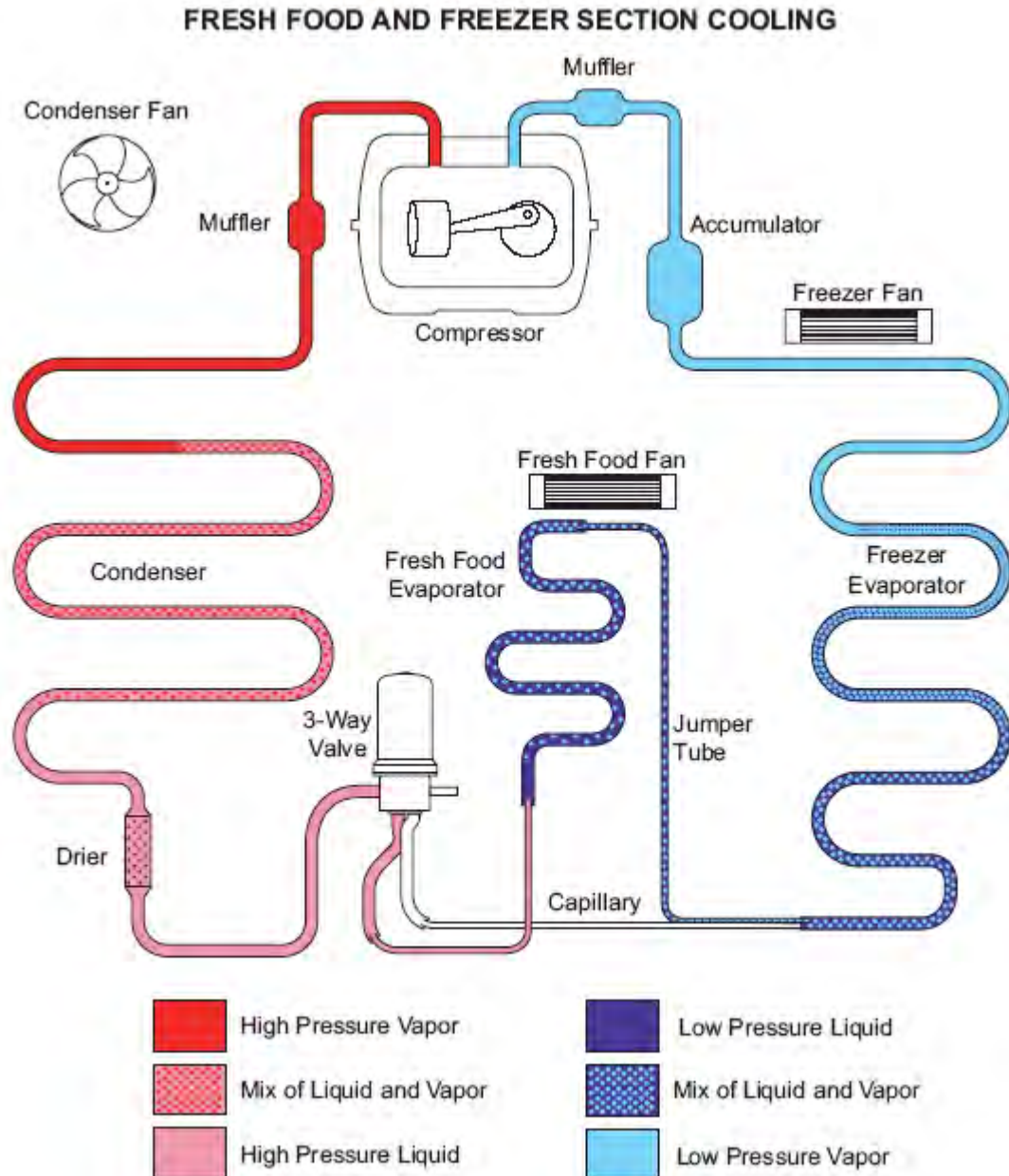

FREEZER SECTION COOLING

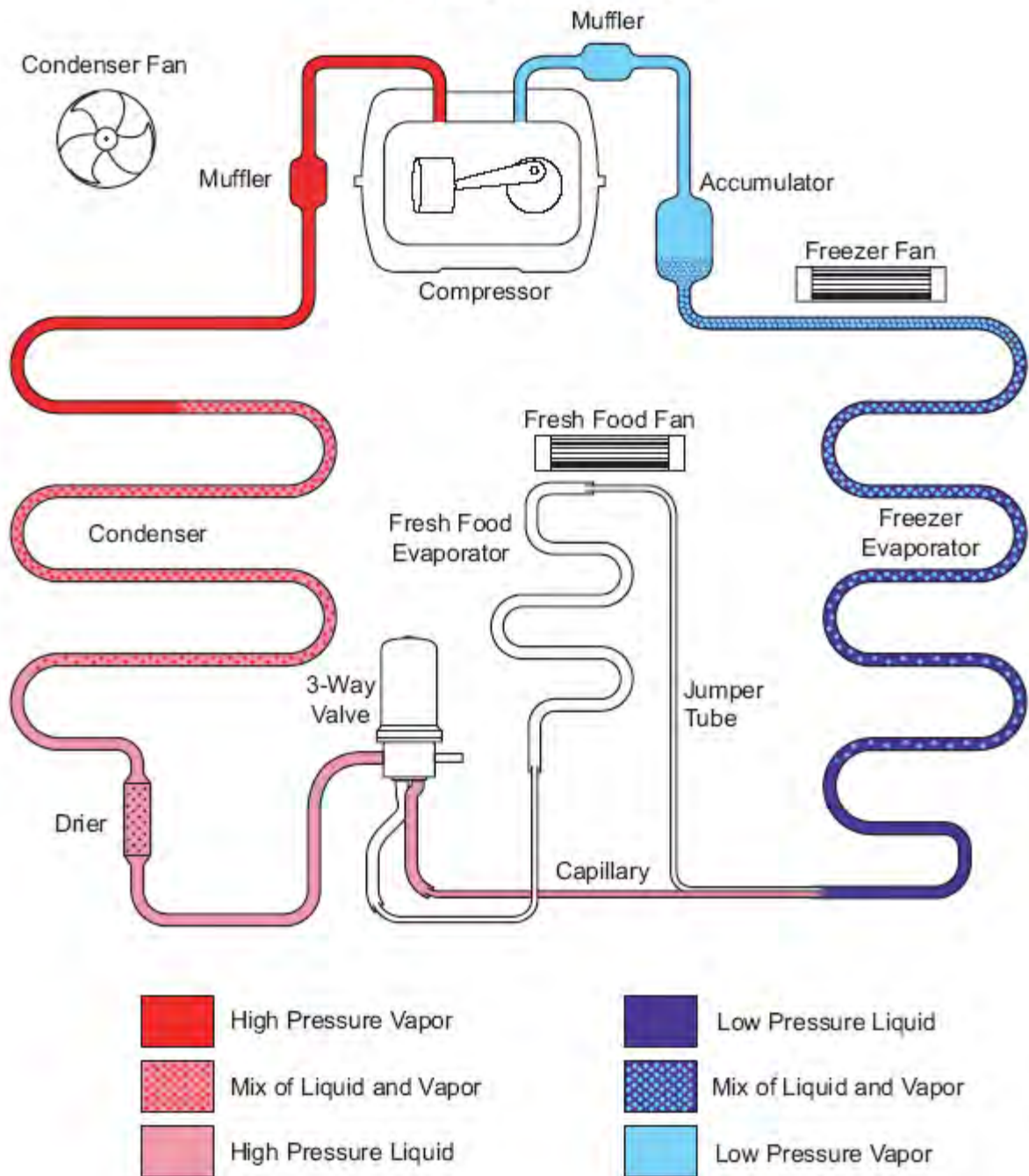

Note: The refrigerator will operate with the 3-way valve set for freezer only or set for fresh food and freezer. There is no 3-way valve setting for fresh food only. If the fresh food thermistor is not satisfied, but the freezer thermistor is satisfied, the refrigerator will still operate with the 3-way valve set in the fresh food and freezer mode.

Evacuation and Charging Procedure

Equipment Needed for Evacuation & Recharging:

- Heated charging cylinder
- Standard 3-port manifold gauge set:
 - 4 charging hoses
 - Tee fitting with valve core stem removed (Robinair No. 40396)
 - Hand shut-off valve (Robinair No.40380)
- Two stage vacuum pump
- Process tube adapter kit (Robinair No. 12458)
- Tubing cutter
- Pinch-off tool capable of making leak proof seal
- Complete brazing torch set
- Small 3-corner file
- Grit cloth or Scotch-Brite
- 45% silver solder and flux

Installing Evacuation and Recharging Equipment

1. Disconnect refrigerator from electrical supply.
2. If compressor was replaced, install correct sized process tube adaptor on process tube. If compressor was not replaced, cut process tube with tubing cutter leaving as much tube as possible and install correct size process tube adaptor.
3. Install correct sized process tube adaptor on high-side process tube.
4. Attach refrigeration service gauge manifold to system in following order:
 - Low-side (compound gauge) hose to suction side process tube adaptor.
 - High-side (pressure gauge) hose to high-side process tube adaptor.
 - Center port manifold hose before hand shut-off valve to charging cylinder.
 - Center port manifold hose after hand shut-off valve to vacuum pump.

Evacuating System

WARNING: R-134A SYSTEMS ARE PARTICULARLY SUSCEPTIBLE TO MOISTURE CONTAMINATION WHICH CAN ONLY BE PREVENTED BY EVACUATING THE SYSTEM FOR A MINIMUM OF 30 MINUTES TO ATTAIN A MINIMUM 29.9 INCH (500 MICRON OR LOWER) VACUUM.

To achieve the required levels of evacuation, a properly maintained two stage vacuum pump in good condition is required. It is absolutely essential to maintain your vacuum pump according to the manufacturer's instructions including required oil changes at the recommended intervals. Vacuum pump oil should always be changed after evacuating a contaminated system.

Vacuum pump performance should be checked periodically with a micron gauge.

1. Make certain that charging cylinder valve, hand shut-off valve, and manifold gauge valves are closed.

2. Start vacuum pump.
3. Open hand shut-off valve and slowly open both manifold valves, turning counterclockwise, for two full rotations.

CAUTION: If high vacuum equipment is used, just crack both manifold valves for a few minutes and then open slowly for the two full turns counterclockwise. This will prevent the compressor oil from foaming and being drawn into the vacuum pump.

4. Operate the vacuum pump for a minimum of 30 minutes to a minimum of 29.9" (500 micron) vacuum.
5. Close hand shut-off valve to vacuum pump. Watch compound gauge for several minutes. If reading rises, there is a leak in the system, go to step 6. If no leak is indicated, stop vacuum pump. System is now ready for charging.
6. If a leak is indicated, stop vacuum pump and introduce a small charge of refrigerant into system by cracking valve on bottom of charging cylinder until system is pressurized to 40 or 50 lbs psig.
7. Leak test low-side. Close compound gauge. Run compressor for a few minutes and leak test high-side. When leak is found, recapture refrigerant using EPA approved recovery system. Repair and go back to step 1.

Charging The System

CAUTION: Check the serial plate for the correct refrigerant type. It is extremely important to verify the type of refrigerant in the system before starting any sealed system repairs.

CAUTION: After charging the system with liquid be certain to wait at least 5 minutes before starting the compressor to give the refrigerant a chance to disperse throughout the system. Otherwise the compressor could be damaged by attempting to pump excessive quantities of liquid.

Preparing The Charging Cylinder:

1. Make certain that hand shut-off valve to vacuum pump is closed.
2. Close high-side manifold gauge valve.
3. Set charging cylinder scale to pressure indicated on cylinder pressure gauge.
4. Observe refrigerant level in sight glass. Subtract amount to be charged into system and note shut off point.
5. Open charging cylinder valve slowly and allow proper charge to enter system.

6. As soon as refrigerant in sight glass has gone down to predetermined level, close charging cylinder valve.

WARNING: DISCONNECT THE CHARGING CYLINDER HEATER AT THIS TIME TO PREVENT THE CYLINDER PRESSURE FROM EXCEEDING ITS MAXIMUM LIMITS.

7. Allow system to sit for five minutes.
8. Turn on refrigerator compressor. Run compressor for a few minutes and monitor system pressures.
9. When satisfied that the unit is operating correctly, clamp the high-side process tube with the pinch-off tool while the unit is still running.
10. Slowly open the high-side manifold gauge valve to allow the compressor to remove any refrigerant trapped in the high-side hose and the process fitting.

11. Close both of the manifold gauge valves. If the high-side gauge reading rises, the pinch-off must be corrected before proceeding.
12. Remove the high-side process tube adaptor and solder the process tube closed.
13. Clamp the low-side process tube with the pinch-off tool while the unit is running. Remove the low-side process tube adaptor and solder the process tube closed.
14. Check the process tubes for refrigerant leaks.

Final leak test

1. With the refrigerator turned OFF leak test all low-side system components.
2. Turn the unit ON and run until the condenser is warm. Leak test the high-side system components.

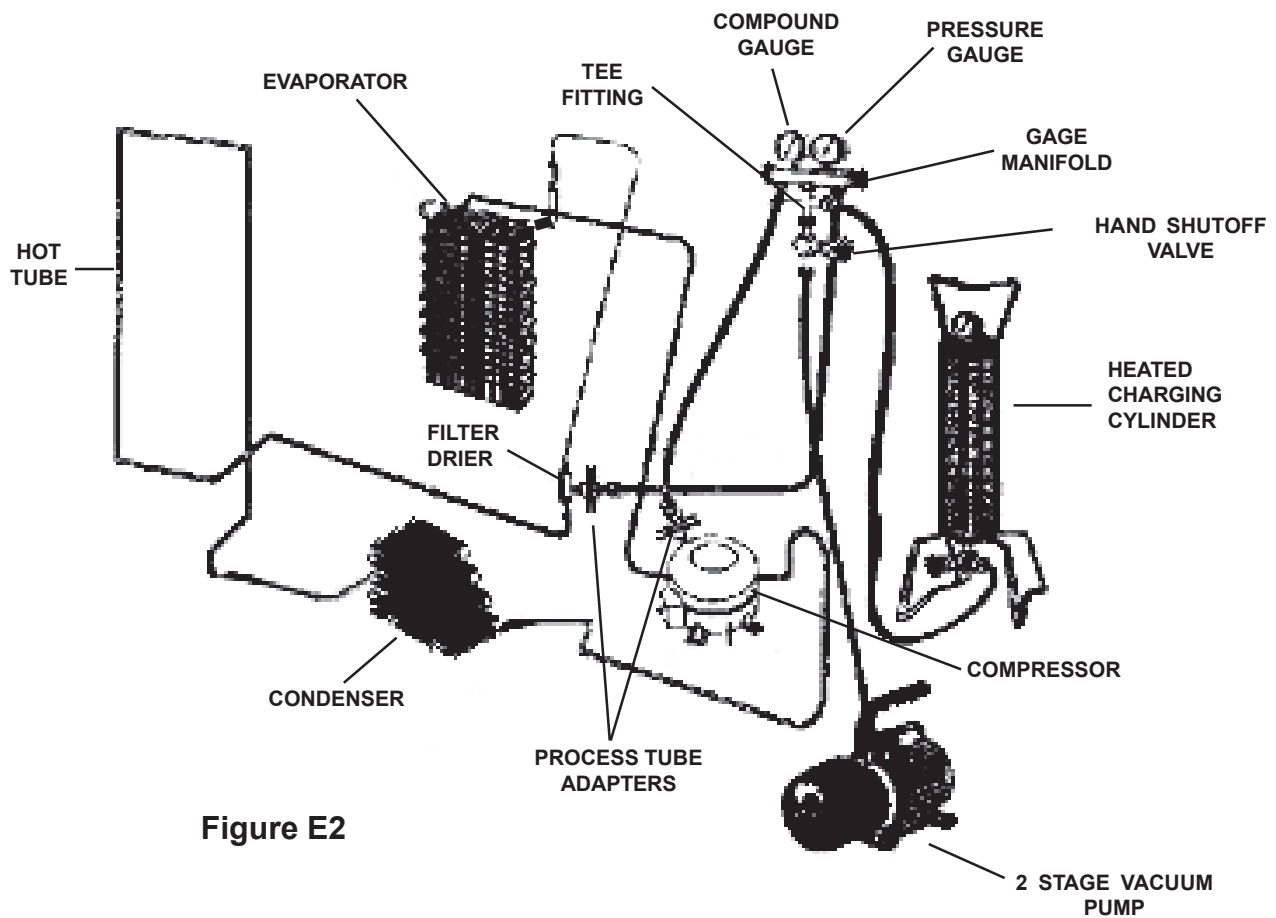

Figure E2

R-134a service information

NOTICE: Instructions given here are furnished as a guide. Persons attempting to use these instructions to make repairs to the sealed refrigeration system should have a working knowledge of refrigeration and previous training on sealed system repair.

Verify refrigerant type in the system

CAUTION: R-134a and R-12 are completely incompatible. Before starting any sealed system repair, it is extremely important to check serial plate of product to verify the type of refrigerant in the system.

Dedicated Equipment

R-134a must not be mixed with other types of refrigerants. R-134a must be recovered in dedicated and properly identified recovery bags and tanks.

It will be necessary to check with the manufacturer of your recovery equipment to determine R-134a compatibility. Some recovery equipment manufacturers have changeover instructions for switching between refrigerant types. Protect yourself and your equipment by following all manufacturer guidelines.

Also, ensure that your refrigeration hoses are specified for use with R-134a refrigerant. Research has shown that compounds in standard refrigeration hoses may enter sealed systems and ultimately restrict the cap tube in an R-134a system.

R-134a refrigeration systems

The sealed refrigeration system will consist of the same basic components being utilized in the R-12 systems.

There is a 10% to 15% discharge pressure increase using R-134a, with a 5% to 10% decrease in suction pressure when compared to the same product with an R-12 system operating at 90°F (32°C) ambient temperature conditions. Lower suction pressures result from the lower density of R-134a refrigerant which effects refrigerant flow rate. R-134a systems commonly operate in a 1"-2" vacuum on the suction side.

Products using R-134a refrigerant will generally have a longer capillary tube to maintain a similar flow rate and some models will have a larger condenser to reduce the discharge pressures and lower start-up sound transmission.

Miscibility of r-134a and ester oil

A special synthetic oil known as Ester oil is used as a lubricant in refrigeration systems operating on R-134a. Ester oils are produced from alcohols and fatty acids

and are available in several different variants. Ester oils have a pleasant aroma reminiscent of fruit.

Ester oils generally include various types of additives for improving certain properties such as viscosity, temperature sensitivity, etc. These additives are often aggressive, and skin contact with Ester oils should therefore be avoided.

One of the most important requirements made on a refrigerant system is that the oil mix with the refrigerant. Since mineral oil and ordinary synthetic oil DO NOT mix with R-134a, Ester oil is used for lubrication. Ester oil dissolves in R-134a.

Ester oil is broken down by chlorine and cannot be used with R-12 (R-12 contains chlorine) or any other compound containing chlorine. Therefore, R-134a refrigeration systems have virtually no tolerance for chlorine molecules from CFC refrigerants (R-134a is an HFC and contains no chlorine).

CAUTION: During R-134a service, it is extremely important to avoid using equipment that may contain residual amounts of mineral oil, CFC's or HCFC's which could enter and contaminate the sealed system.

For example, hoses that were used for a refrigeration system operating on R-12 may contain small quantities of mineral oil which can block the capillary tube in a system operating on R-134a. As little as one milligram may be sufficient to cause a blockage. In addition, sealed system components that have been used with CFC systems must not be used with R-134a systems. These components may contain residual amounts of refrigerant and oil which could damage an R-134a system.

At the earliest stage of development work on R-134a, tests were carried out on a different type of synthetic oil known as Poly-Alkaline Glycol (PAG). This oil is also used in certain air conditioning systems for cars. PAG and Ester oil DO NOT mix with one another. Service equipment used for R-134a / Ester oil must not come into contact with PAG.

Water in the refrigeration system

Even in very small quantities, water in any refrigeration system can cause the following problems:

- Ice plugs in capillary tubes.
- Copper plating in compressor.
- Reactions with organic materials in systems.
- Corrosion of metals.

R-134a and Ester oil will aggravate the problem of water in the refrigeration system. Ester oil may react with water vapor and is hygroscopic (it will absorb water if it comes in contact with humid air). Water is also more soluble in R-134a than R-12.

To minimize the water content whenever service work is performed, the refrigeration system should always be thoroughly evacuated through process tube adaptors on both the high and low sides of the system. Evacuation must be for a minimum of 30 minutes to at least a 29.9 inch (500 micron) vacuum.

VACUUM CHART		
Vacuum Inches Hg.	Microns	Boiling Point of Water °F
28.940	25000	77.9
29.530	10000	52.0
29.832	4600	32.0
29.882	1000	1.0
29.901	500	-11.2
29.915	150	-32.8
29.917	100	-38.2
29.919	50	-49.0

To achieve the required 29.9 inch (500 micron) vacuum, a properly maintained two-stage vacuum pump in good condition is required. A two stage pump can reach a deeper vacuum than a single stage because the exhaust from the first pumping stage is discharged into the second pumping stage. This means the second stage begins pumping at a lower pressure so a lower ultimate vacuum can be achieved (See 2-Stage Vacuum Pump, Figure E3).

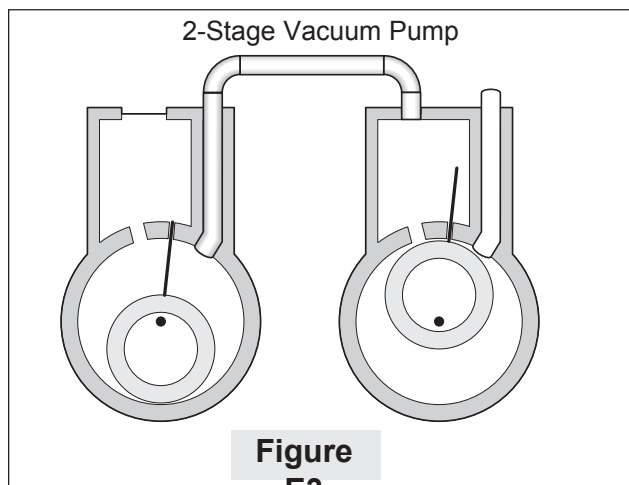

Vacuum pump maintenance

It is absolutely essential to maintain your vacuum pump according to the manufacturer's instructions including required oil changes at the recommended intervals. Vacuum pump oil should always be changed after evacuating a contaminated system. Vacuum pump performance should be checked periodically with a micron gauge.

Vacuum pump suppliers may or may not recommend changing the vacuum pump oil to the same type that's in the system being evacuated. Some manufacturers may recommend a vacuum pump that's dedicated to R-134a systems.

Robinair has stated that their current and discontinued vacuum pump models, using mineral oil currently specified for use in their vacuum pumps, can be used to evacuate R-134a/Ester oil systems. Robinair also states that it is acceptable to alternate between evacuating R-12/mineral oil and R-134a/Ester oil systems without adversely effecting the vacuum pump's performance.

For other brands of vacuum pumps, check with the manufacturer for restrictions and guidelines when using with R-134a.

CAUTION: If you use a vacuum pump with mineral oil to evacuate an R-134a system, it is ABSOLUTELY ESSENTIAL to have a shut-off valve between pump and your manifold gauge set as shown in Figure E4. The hand valve must be closed during all times when vacuum pump is not operating. This will prevent migration of mineral oil vapor into R134a/Ester oil system. If vacuum pump should stop during evacuation for any reason, the hand pump shut-off valve must be closed immediately.

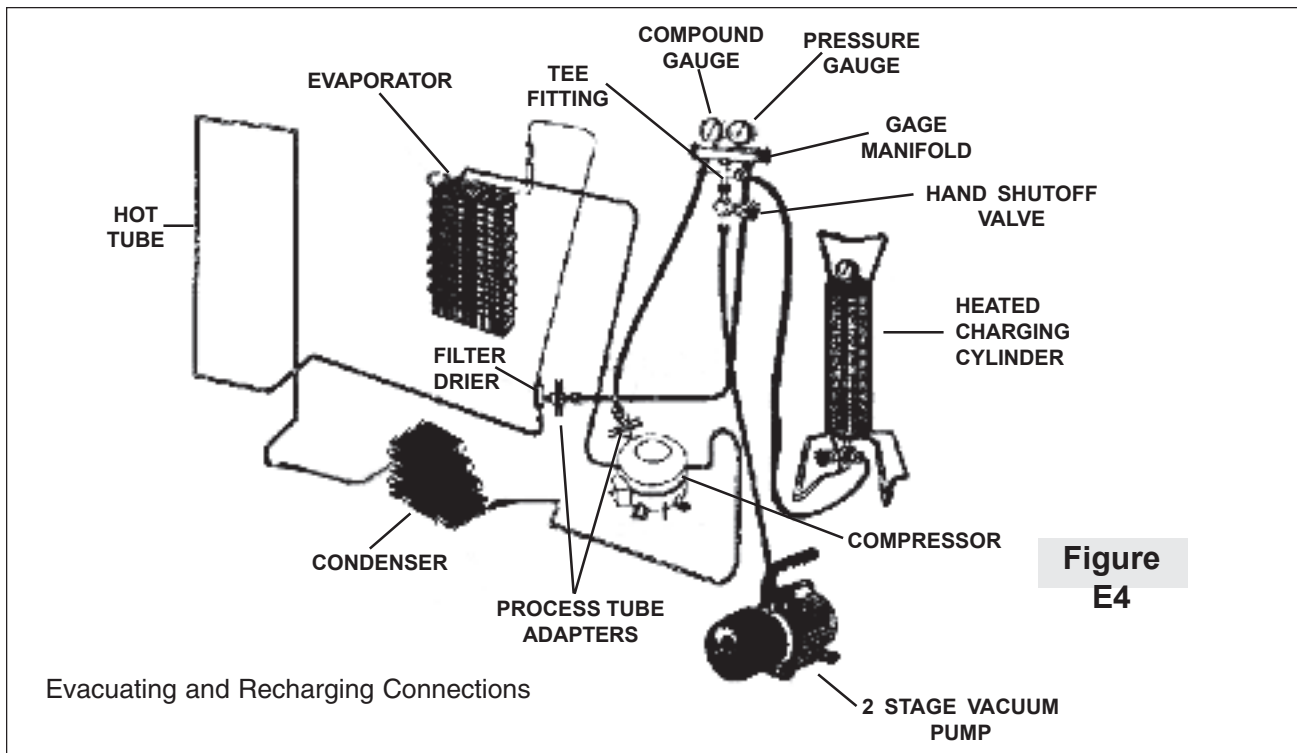

Refrigerant leaks

A system with R-134a and Ester oil will become saturated with moisture much faster than a system with R-12 and mineral oil. The compressor in an R-134a system will have to be replaced if the product has had a low side leak.

R-134a refrigerant molecules are smaller than R-12 molecules. This means that R-134a will pass more minor leaks and the rate of flow will be greater than for R-12. Therefore, it is now more important than ever to follow good brazing practices. Use a good grade of silver solder. 45% silver solder is recommended.

leak detection

R-134a system leaks can be pinpointed by means of an electronic leak detector or by bubble solution.

Electronic leak detectors for R-134a service are currently available from several manufacturers. The least expensive models are non-selective detectors that will detect any type of emission or vapor present, regardless of its chemical composition. Some non-selective detectors designed for use with R-12 may have a much lower sensitivity when used with R-134a. However, newly designed detectors with good R-134a sensitivity are now available. Be sure to consult with the manufacturer before selecting or using a non-selective detector with R-134a.

Halogen-specific detectors use a specialized sensor that allows detection of compounds containing chlorine, fluorine, bromine, and iodine without being activated by other species. The major advantage of this type of detector is a reduction in the number of "nuisance alarms". Halogen-specific detectors are generally more expensive

than non-selective detectors but feature higher sensitivity. R-134a properties

R-134a properties

The properties of R-134a are very similar to those of R-12. The principal data for the two refrigerants are shown in the chart below.

	REFRIGERANTS	
	R-12	R-134a
NAME	Dichlorodifluoromethane	1,1,1,2--Tetrafluoromethane
Formula	CCl_2F_2	$\text{CH}_2\text{F}-\text{CF}_3$
Molecular Weight (g/mol)	120.93	102.3
Ozone Depletion Potential (ODP)	1	0
Global Warming Potential (GWP)	3.1	0.3
Boiling Point °F	-21.6	-15.7
Vapor Pressure (77°F)	80 psig	82 psig
Flammability	None	None
Solubility of Water in Refrigerant (wt% @ 77°F)	0.009	0.11

Evacuation and Charging Procedure using Sweep Charge.

WARNING:

- Before cutting or using a torch on refrigerant tubes, recover the refrigerant from the system using approved recovery equipment.
- Never charge new refrigerant through the purge valve. This valve is always located on the high pressure side of the system.
- Never apply heat from any source to a container of refrigerant. Such action will cause excessive pressure in the container.
- Always wear goggles when working with refrigerants and nitrogen holding a charge in some replacement parts. Contact with these gases may cause injury.

1. Attach the hose from the R-134a charging cylinder to the process tube port on the compressor.
2. Evacuate the system to a minimum 20-in. vacuum using the refrigerator compressor and recovery pump, which is attached to the new drier assembly.
3. Turn off the recovery pump. Close the ball valve on the hose connected to the high-side port connection. Add 3 ounces of R-134a refrigerant to the system. Let the refrigerator operate and circulate the refrigerant for 5 minutes.

4. Open the ball valve. Recover the purge/ sweep charge using the recovery pump and the refrigerator compressor until a 20-in. vacuum is attained. Close the ball valve and remove the recovery hose.
5. Charge the system with the exact amount of R 134a refrigerant specified.
6. Disconnect the power cord to the refrigerator. This allows the pressure to equalize. After 3 to 5 minutes, the low-side pressure will be positive and then the hose-to-charging port can be disconnected.
7. Using an electronic leak detector, check all brazed joints and both schrader ports. Reinstall caps to schrader ports.

Interior Airflow

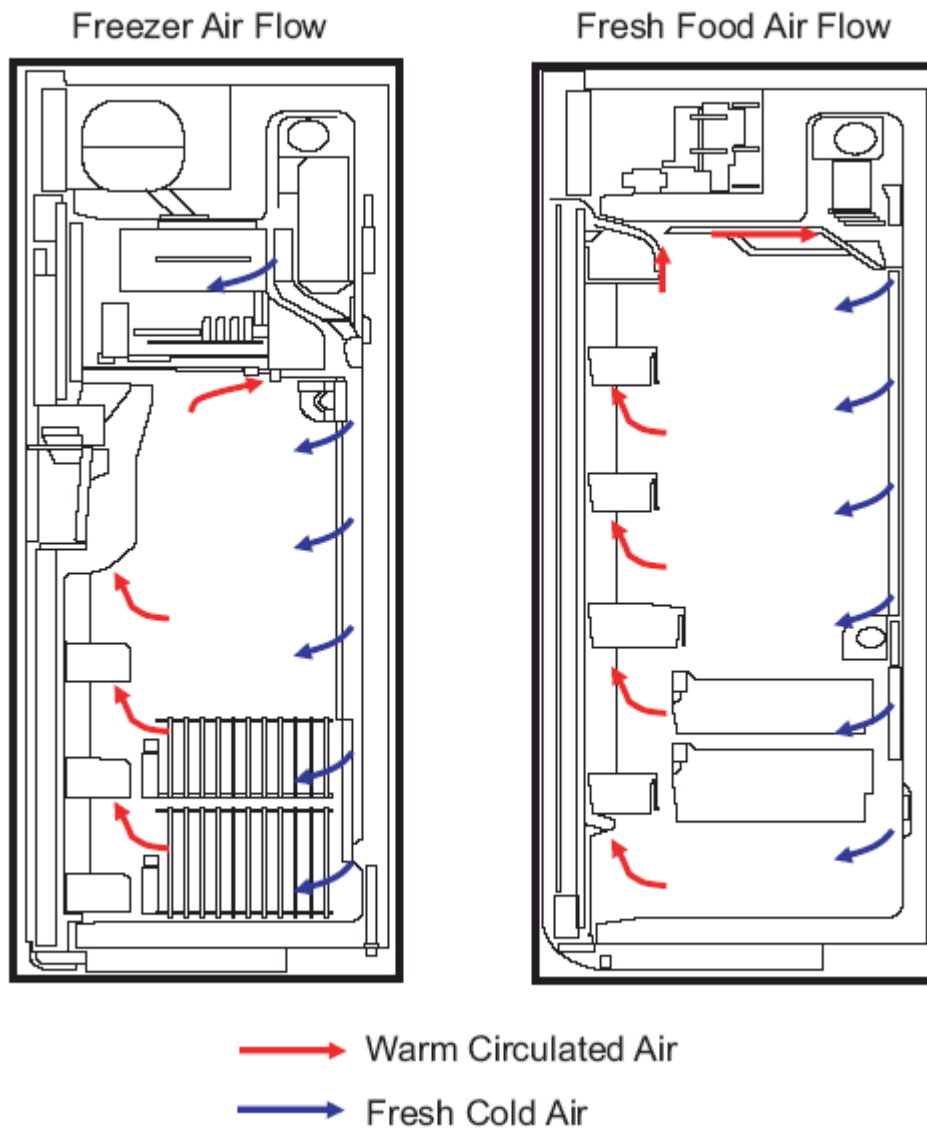

Note: The fans are extremely quiet. Check for airflow at the icemaker air duct in the freezer and the top tower vent in the fresh food section. Fans turn off when the doors are opened (DC door switches control operation) and delay 10 seconds before restarting when the doors are closed again. The freezer door switch controls only the freezer fan. The fresh food door switch controls both the fresh food and freezer fan operation.

Components

Machine Compartment Access Door

The machine compartment access door is held in place by 2 hinges and 2 gas shocks.

To remove the machine compartment access door:

1. Remove the grille panel.
2. Remove the gas shocks from the cabinet:
 - a. Insert a small screwdriver under the retainer clip.
 - b. Pull the retainer inward to dislodge the gas shock from the pivot ball.
3. Remove the 2 screws from both hinges, then remove the machine compartment access door.

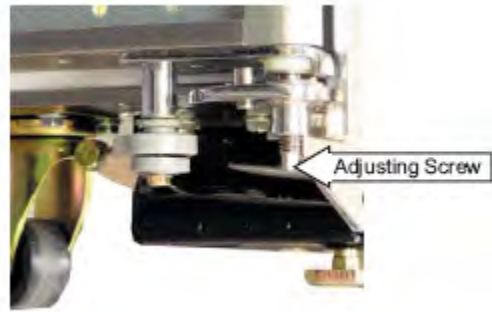

does not allow the door to swing open fully to 130°, the stop can be adjusted to a 90° door swing. The pin is factory installed in the 130° location. To change the stop location, use a flathead screwdriver to move the stop pin.

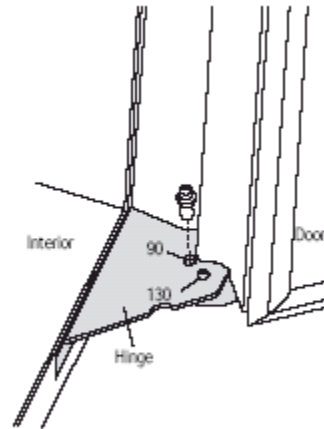

Doors

The doors are of one-piece construction with foamed-in insulation. The inner and outer door panels cannot be separated and must be replaced as an assembly.

Note: On trimmed models, the maximum weight for the fresh food door panel is 70 pounds. The maximum weight for the freezer door panel is 30 pounds.

Door Alignment

The freezer door is nonadjustable. The fresh food door has an adjustment screw at the bottom hinge. Use a 7/32-in. socket or open-end wrench to turn the adjusting screw clockwise to raise the door, or counterclockwise to lower the door. A lockin screw using a Phillips head screw is used to hold the adjusting screw in place. You must loosen this screw to adjust the door.

Note: Raising the fresh food door too high will cause the upper hinge to bind on the machine compartment access door.

Door Stop

The refrigerator has a 2-position door stop. When space

Door Removal

WARNING: Use the appropriate safety equipment and lifting techniques. Two persons may be required for door removal.

Caution: Use wood or a heavy plastic sheet to protect the floor where the door will be placed.

1. Remove the 8-mm mounting screw from the hinge arm link using a 5/16-in. or 8-mm socket.



2. If removing the freezer door, shut off the water supply and disconnect the water line and electrical connectors. If removing the refrigerator door, disconnect the static ground wire from the grounding screw.

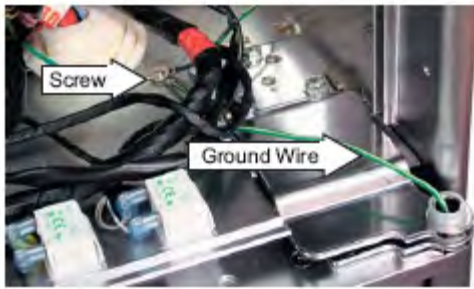

3. Remove the upper hinge.
4. Lift the door up and out.

Door Gaskets

The fresh food and freezer doors have magnetic gaskets that create a positive seal to the front of the steel cabinet. The cabinet has magnets around the perimeter and center mullion under the front edge.

Shown With Plastic Liner Removed

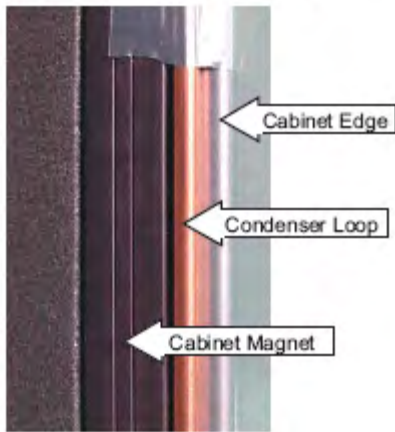

The magnetic door gaskets are secured to the doors by a barbed edge that locks into a retainer channel.

To remove and replace the door gasket:

1. Starting at any corner, pull the old gasket out of the retaining channel.
2. Soak the new gasket in warm water to make it pliable.
3. Push the barbed edge of the gasket into the retainer channel.



Door Closer Assembly

Each door is equipped with a door closer assembly that provides a smooth closing action and prevents the door from being slammed shut. The assembly is connected to the bottom hinge. When the door is open to a 90° position, it will automatically close. Beyond this position, the door will stay open.

To remove the door closer assembly:

1. Remove the toe plate.
2. Remove the 8-mm mounting screw.
3. Insert a small screwdriver into the retaining clip at the bottom of the shock absorber and lift up (see photo).
4. Using a large screwdriver, lever the shock absorber off the pivot ball as shown.

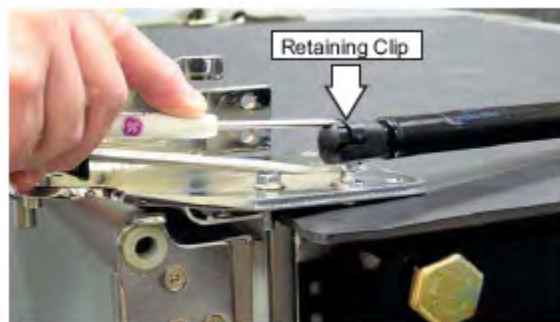

5. Remove the door closer assembly by pulling it forward. Make certain to retain the white nylon shock absorber support.

To install the door closer:

1. To make installation of the shock absorber easier, secure the white nylon support to the cylinder body with electrical tape.



2. Ensure the opening on the white nylon support faces towards the inside of the cabinet.



NOTE: Tape in place when installing in the field, this will prevent support from falling off before closer is in place.

3. Make sure the door closer assembly support is fully seated in the bracket to ensure alignment of ball and socket.

Shown from Installation Viewpoint

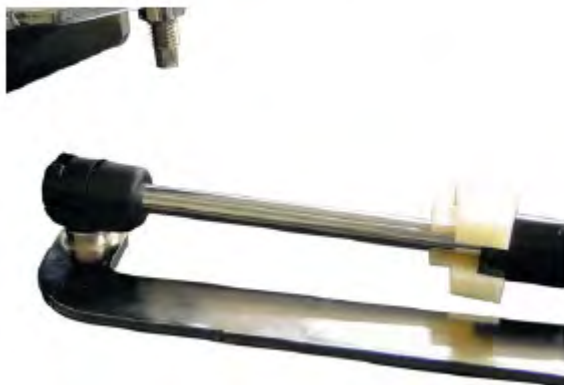

Side Magnet Replacement

1. Remove side case trim.

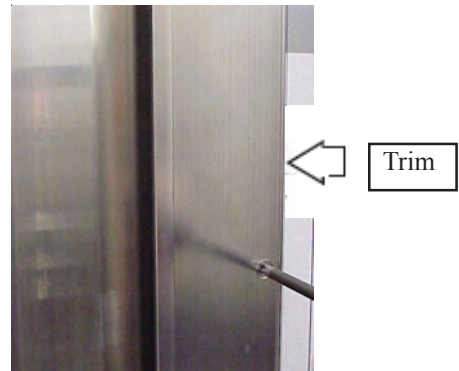

2. The hot gas loop will be visible between the front baker strip and cabinet. Carefully move the hot gas loop tubing out of the space between barker strip and cabinet. The case magnet is behind the hot gas loop tubing.

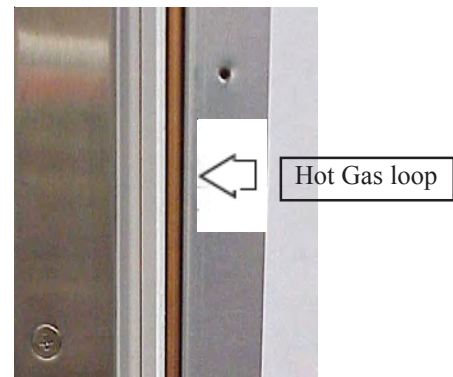

3. With the hot gas loop out of the channel, the cabinet magnet can be removed from the channel, using a flat screw driver or putty knife to assist.

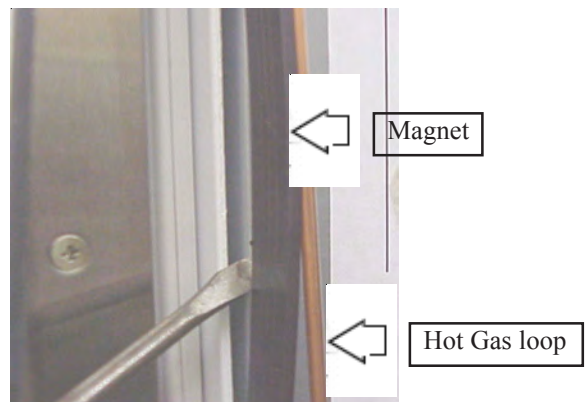

4. Rotate magnet and reinsert into breaker/cabinet channel.
5. Reinsert hot gas loop tubing in breaker/cabinet channel
6. Tape may be necessary to hold hot gas loop tubing in channel while trim is installed.
7. Re-install side trim.

Casters and Leveling

Leveling is provided by 2 adjustable rear levelers and 2 front leveling legs. The unit has 4 fixed casters that are used to position the refrigerator. When adjusting the rear levelers, turn the 7/16-in. hex nut, located above the front casters, clockwise to lower, or counterclockwise to raise. When adjusting the front legs, use an open-end wrench and turn the front legs clockwise to lower, or counterclockwise to raise.

Note: The rear levelers and the 4 casters are each attached to the refrigerator with four 10-mm screws. To access the screws, raise or tilt the refrigerator.

Bottom Right Half of Refrigerator Shown

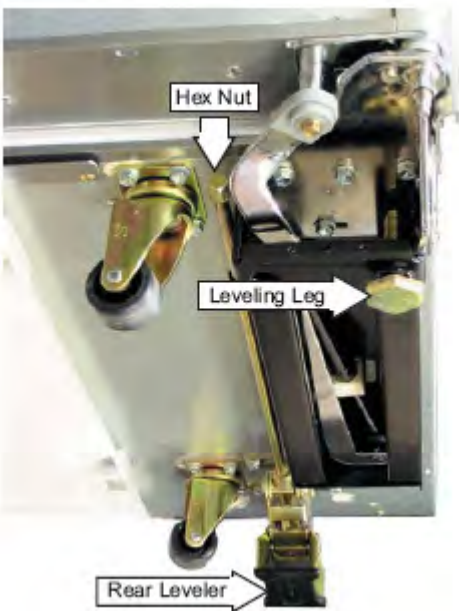

The defrost water in the pan is evaporated by use of a submersible serpentine coil, which is part of the sealed system. The tubing is copper coated with black paint.

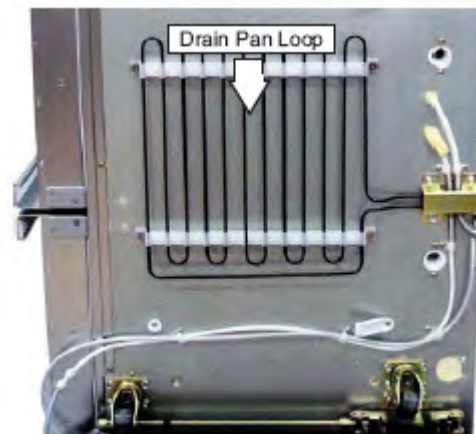

Warning: Use the appropriate safety equipment and lifting techniques. Two persons may be required.

Drain Pan

The drain pan can be removed for cleaning purposes.

Drain pan removal:

1. Remove the toe plate.
2. To remove the drain pan, grasp the center of the drain pan and pull outward.
3. To install the drain pan, slide it back into position so the rear and front mounting tabs engage.
4. Firmly push the drain pan into position.

Power Control Board (PCB)

The PCB housing is attached to the rear wall of the machine compartment by 2 Phillips-head screws.

The PCB is enclosed inside a housing and mounted on the right side of the machine compartment behind the terminal block panel.

Noise Filter

The noise filter is mounted in a recessed area in the PCB housing.

To access the noise filter:

1. Remove 3 screws from the

filter cover.

2. Disconnect the 2 lead wires.

3. Remove the 13-mm hex nut at the end of the noise filter that holds the ground wire in place.

To check the noise filter, look for the epoxy molding to be broken or burnt by heat or a power surge.

The noise filter resistance should be approximately 500K Ω between the black and red wires.



Control Board Connector Locator

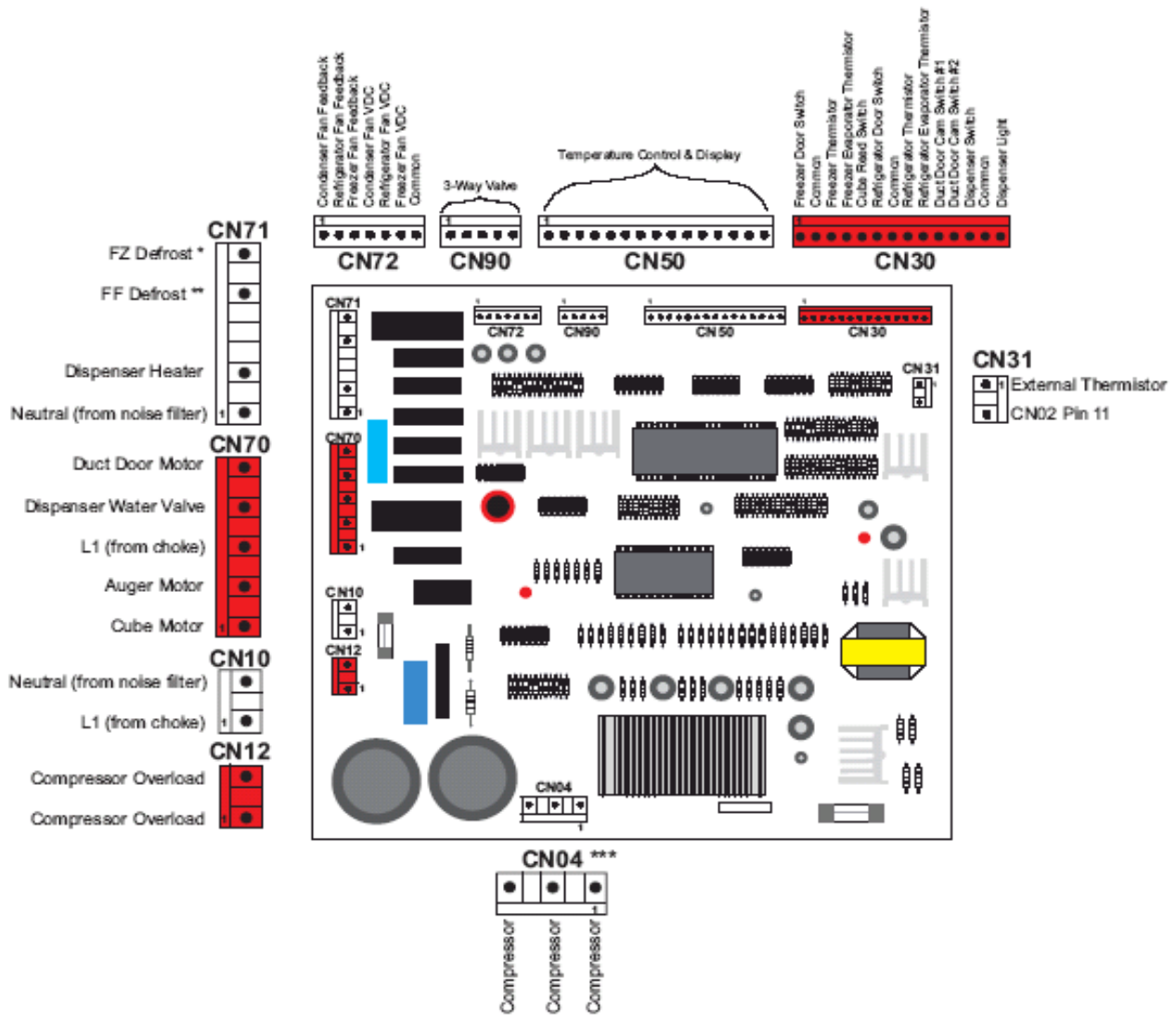

* FZ Defrost - Freezer defrost circuit consists of the defrost heater, bi-metal thermostat, drain pan and tube heater and suction line drain pan heater.

** FF Defrost - Fresh food defrost circuit consists of the defrost heater, bi-metal thermostat, drain pan heater and icemaker fill tube heater.

*** CN04 on the control board connects to the CN8 connector on the terminal block panel.

Terminal Block Panel

The terminal block panel is located on the right side of the machine compartment and attached to the PCB housing cover. The terminal block consists of AC and DC wire harness connectors.

To access the wire harness connectors, remove the 4 Phillips-head screws that hold the front cover in place.
Front Cover

Terminal Block Panel with Cover Removed



Connector Locator

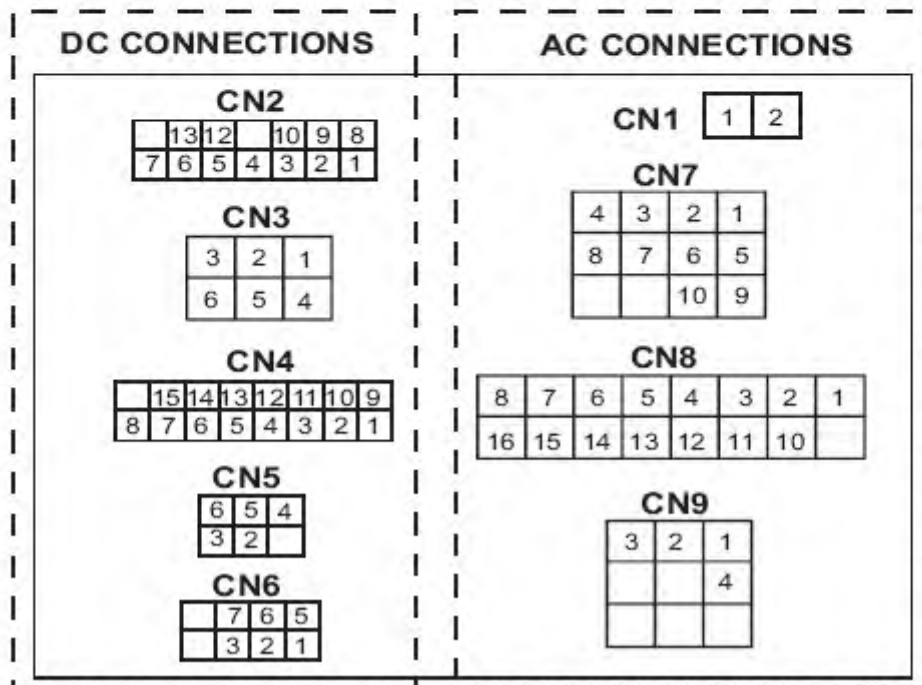

Note: Through the service guide, reference to the terminal block connectors may or may not contain a zero (i.e., CN3 and CN03 are the same connector)

Connector Description

DC CONNECTIONS			
CON	PIN	DESCRIPTION	WIRE COLOR
CN2	1	Condenser Fan Feedback	Red
CN2	2	Condenser Fan VDC	Light Blue
CN2	3	Condenser Fan Common	Gray
CN2	4	3-Way Valve	Red
CN2	5	3-Way Valve	Black
CN2	6	FZ Door Switch	White/Yellow
CN2	7	FZ & FF Door Switch (Common)	Gray
CN2	8	3-Way Valve	Blue
CN2	9	3-Way Valve	Yellow
CN2	10	3-Way Valve	Orange
CN2	11	Empty	
CN2	12	External Thermistor	Red
CN2	13	FF Door Switch	White/Blue
CN2	14	Empty	

CN3	1	Duct Door Cam Switch #1	Blue
CN3	2	Duct Door Cam Switch #2	Purple
CN3	3	Dispenser Switch	White
CN3	4	Dispenser Components (Common)	Gray
CN3	5	Dispenser Light	Light Blue
CN3	6	Empty	

CN4	1	Temperature Control & Display	Black
CN4	2	Temperature Control & Display	Brown
CN4	3	Temperature Control & Display	Red
CN4	4	Temperature Control & Display	Orange
CN4	5	Temperature Control & Display	Yellow
CN4	6	Temperature Control & Display	Pink
CN4	7	Temperature Control & Display	Blue
CN4	8	Temperature Control & Display	Purple
CN4	9	Temperature Control & Display	Gray
CN4	10	Temperature Control & Display	White
CN4	11	Temperature Control & Display	Light Blue
CN4	12	Temperature Control & Display	White/Black
CN4	13	Temperature Control & Display	White/Red
CN4	14	Temperature Control & Display	White/Blue
CN4	15	Temperature Control & Display	White/Yellow
CN4	16	Empty	

CN5	1	Empty	
CN5	2	FF Fan & Thermistors (Common)	Gray
CN5	3	FF Thermistor	Yellow
CN5	4	FF Evaporator Thermistor	Pink
CN5	5	FF Fan Feedback	Brown
CN5	6	FF Fan VDC	Orange

CN6	1	FZ Fan Feedback	Black
CN6	2	FZ Fan VDC	Yellow
CN6	3	FZ Fan, Thermistors & Cube Switch (Common)	Gray
CN6	4	Empty	

AC CONNECTIONS			
CON	PIN	DESCRIPTION	WIRE COLOR
CN1	1	L1 (Switched thru Master Switch)	Black
CN1	2	Neutral (Switched thru Master Switch)	Red

CN7	1	FZ Defrost (Switched L1)	Brown
CN7	2	FZ Defrost (Neutral)	Orange
CN7	3	Ice maker (L1)	Black
CN7	4	Ice maker (Water) (Switched L1)	Blue
CN7	5	Ice maker (Neutral)	Red
CN7	6	Auger & Cube Motor (Switched Neutral)	R/Blue
CN7	7	Cube Motor (Switched L1)	Light Blue
CN7	8	Auger Motor (Switched L1)	Pink
CN7	9	FZ Light (L1)	Black
CN7	10	FZ Light (Switched Neutral)	White/Blue
CN7	11	Empty	
CN7	12	Empty	

CN8	1	Water Valve (Ice maker) (Switched L1)	Purple
CN8	2	Water Valve (Dispenser) (Switched L1)	Gray
CN8	3	Water Valve (Neutral) (Ice maker & Dispenser)	Red
CN8	4	Duct Door Motor & Dispenser Heater (Neutral)	Red
CN8	5	Dispenser Heater (Switched L1)	Brown
CN8	6	Duct Door Motor (Switched L1)	White
CN8	7	Compressor (3 Phase)	Black
CN8	8	Compressor (3 Phase)	Purple
CN8	9	Empty	
CN8	10	FZ Door Switch (Auger & Cube Motor)	R/Blue
CN8	11	FF Door Light Switch (Switched Neutral)	Yellow
CN8	12	FZ Door Light Switch (Switched Neutral)	Orange
CN8	13	FF Door Light Switch (L1)	Black
CN8	14	Compressor Overload (Pwr Supply Neutral)	Light Blue
CN8	15	Compressor Overload (Pwr Supply Neutral)	Light Blue
CN8	16	Compressor (3 Phase)	Blue

CN9	1	FF Defrost (Switched L1)	White
CN9	2	FF Defrost (Neutral)	Red
CN9	3	FF Lights (Switched L1)	Light Blue
CN9	4	FF Lights (Neutral)	Red
CN9	5	Empty	
CN9	6	Empty	
CN9	7	Empty	
CN9	8	Empty	
CN9	9	Empty	

Ice Bin and Icemaker

Ice Bin

The ice bin holds approximately 7 pounds of ice, equivalent to about 230 cubes.



The ice bin can be removed by lifting it upward, to clear the tabs holding the bin in place, then pulling forward.

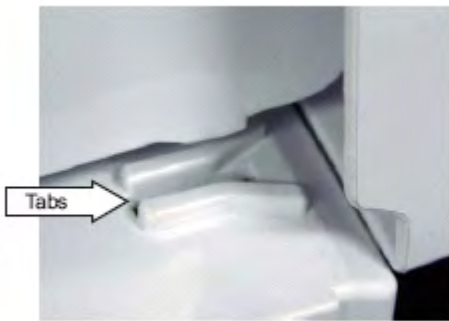

Icemaker

The icemaker is mounted to the upper left wall of the freezer cabinet. Under normal operating conditions, the icemaker is capable of producing approximately 4.3 pounds of ice in a 24-hour period. During **QUICK ICE**, the icemaker is capable of producing 5.5 pounds of ice in a 24-hour period.

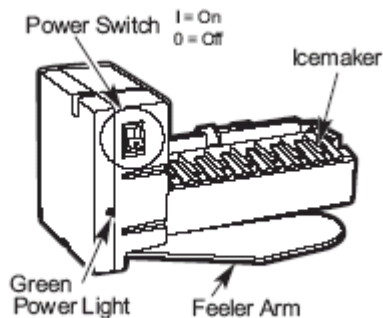

To remove the icemaker:

1. Remove the ice bin. Remove 2 front screws that hold the ice bin shelf in place.

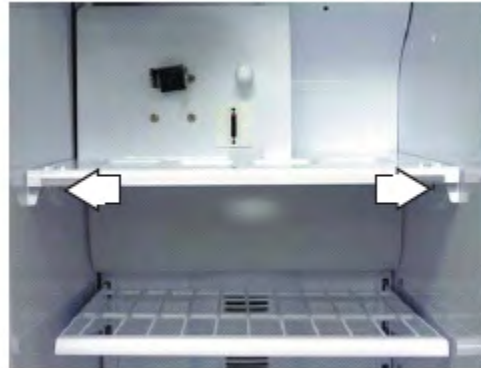

2. Pull the shelf forward to access the icemaker plug, then unplug the icemaker.
3. Remove the 2 screws that hold the icemaker in place. Remove the icemaker.

Check for 120 VAC to the icemaker at CN07 on the terminal block between pin #3 (power) and pin # 5 (neutral).

Icemaker Fill Tube and Heater

To remove the icemaker fill tube and heater:

1. Remove the ice bin and icemaker (see *Ice Bin and Icemaker*).
2. Remove the elbow from the end of the fill tube.

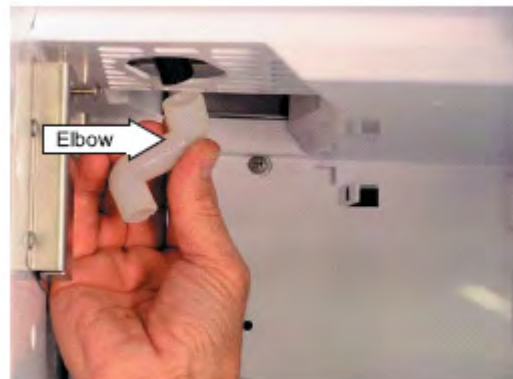

3. In the machine compartment, remove the 2 screws from the fill tube cover (located beneath the water valve to the left of compressor).



4. Disconnect the fill tube water line, then remove the fill tube from the cabinet.

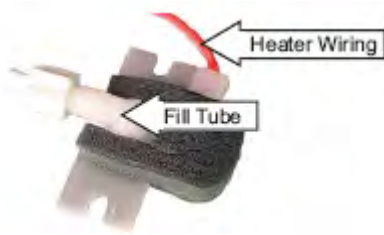

5. The heater is attached to the fill tube and can be separated from the tube by removing the tape and foil.



Note: The heater is supplied with 120 VAC only during the fresh food evaporator defrost cycle. The fill tube heater is in parallel with the fresh food evaporator defrost heater and the fresh food drain heater. The fill tube heater is also referred to as the “PIPE HEATER” on some schematics and “SUB-HEATER FF” in early mini-manuals. When the fresh food defrost cycle is initiated, check for 120 VAC at CN09 on the terminal block, between pin #1 and pin #2.

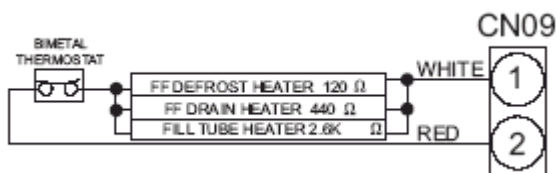

Auger Motor

The auger motor is mounted to the ice bin shelf.

To access the auger motor:

1. Remove the ice bin (see *Ice Bin and Icemaker*).
2. Remove the 2 screws that hold the ice bin shelf in place.



3. Pull the shelf forward to expose the electrical connectors.
4. Disconnect the auger motor wire harness and remove the ice bin shelf.
5. Unsnap the auger motor cover to access the auger motor. The auger motor is held in place by 4 Phillips-head mounting screws.



The auger motor operates on 120 VAC and has a resistance of approximately 3.7 Ω.

To check the supply voltage to the auger motor, select **CUBED** on the ice dispenser control panel, then press the dispenser pad to close the switch. Check for 120 VAC at CN07 on the terminal block between pin #6 and pin #8.

Cube Motor and Cube Reed Switch

The cube motor replaces the cube solenoid assembly and is mounted to the ice container shelf.

To access the cube motor and reed switch:

1. Unsnap the cover.
2. Remove the 2 screws that attach the cube motor assembly to the ice bin shelf.
3. Disconnect the wire harness.

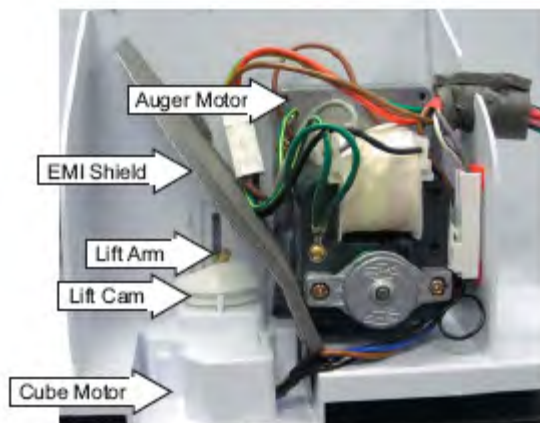

The EMI shield prevents electrical interference from the auger motor from affecting the operation of the cube

motor reed switch. Make sure the shield is in place before replacing the cover.

The cube motor operates on 120 VAC and has a resistance of approximately 2K W.

Note: The auger motor thermal overload is in the cube motor circuit.

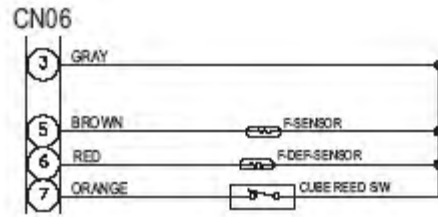
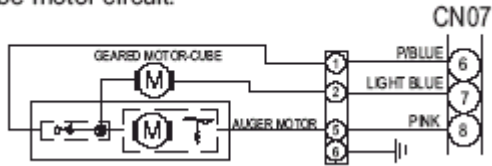

To check the supply voltage to the cube motor, select **CUBED** on the ice dispenser control panel, then press the dispenser pad to close the switch. Check for 120 VAC at CN07 on the terminal block between pin #6 and pin #7. The cube reed switch is mounted to the cube motor housing. A small magnet is attached to the motor lift cam. The magnetic operation of the reed switch informs the power control Board (PCB) of the position of the cube motor lift cam.

To check the cube reed switch:

1. Select **CUBED** on the ice dispenser control panel, then press the dispenser pad to close the switch.
2. Check for 5 VDC at CN06 on the terminal block between pin #3 and pin #7.
3. Select **CRUSHED** on the ice dispenser control panel, then check for 0 VDC at the same pin location with the dispenser switch in the closed position.

Shown with Motor Removed



Note: The motor, cam, reed switch, and harness are replaced as a complete assembly.

Dispenser Control Panel

The dispenser control panel contains the control module and room ambient thermistor. The panel is available in black or white. Stainless steel models come with black trim. To remove the dispenser control panel on stainless steel front models, insert a flat-bladed screwdriver and lift the frame outward to release the 15 retaining hooks from the freezer door. Protect the freezer door with cloth or tape to prevent marring the surface.

To remove the dispenser frame on trimmed models, remove the door handle first, then slide out the top panel. The dispenser cover can then be removed by pulling it away from the door front.

Note: Some force is required to remove the trim frame.



Control Module

- The control module is located on the back of the dispenser control panel.
- The control module is held in place by 8 Phillips-head screws.
- The ambient thermistor is clipped to the bottom of the module housing.

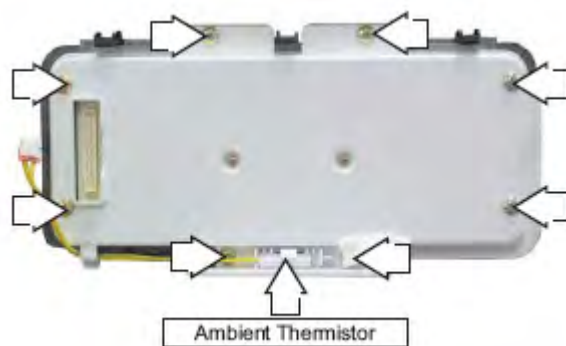

Testing the Dispenser Control Pads

Run the HMI Self-Test 06 (see *Service Diagnostics*). If any portion of the test fails, the control module pads can be tested at the CN04 connector on the terminal block (see *Terminal Block Panel*).

Disconnect the CN04 connector and read the resistance between the wires to the control module. When each pad is pressed, a reading of approximately 10K W should be present between the pins as shown in the chart below. As an example, when the **REFRIGERATOR COLDER** pad is pressed, 10K W should be present between the purple and white/blue wires (pin #8 and pin #14).

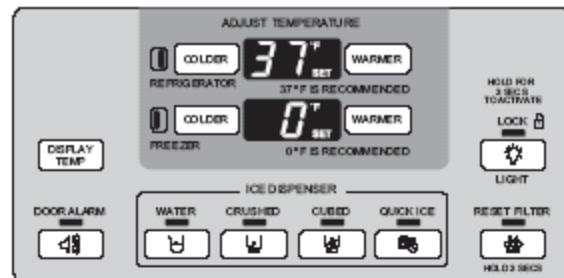

Pad Description	Pin	Wire	Pin	Wire
REFRIGERATOR COLDER	8	Purple	14	White/Blue
REFRIGERATOR WARMER	9	Gray	14	White/Blue
FREEZER COLDER	10	White	14	White/Blue
FREEZER WARMER	11	Light Blue	14	White/Blue
DISPLAY TEMP	12	White/Black	14	White/Blue
DOOR ALARM	13	White/Red	14	White/Blue
WATER	8	Purple	15	White/Yellow
CRUSHED	9	Gray	15	White/Yellow
CUBE	10	White	15	White/Yellow
QUICK ICE	11	Light Blue	15	White/Yellow
RESET FILTER	12	White/Black	15	White/Yellow
LIGHT/LOCK	13	White/Red	15	White/Yellow

Ice Dispenser

The water, crushed ice, and cubed ice functions are controlled by the power control board (PCB).

To select a function, press the appropriate pad on the dispenser. The LED will light to identify the selection. To dispense the selected item, depress the dispenser pad located in the recessed area. With any ice selection, the duct door motor and cam will open the chute door, and upon release, delay its closure. A motor and cam replace the more familiar duct door solenoid. Filter with the bypass plug.

When **CUBED** is selected on the ice dispenser control panel, the cube motor behind the ice bin rotates. The motor cam lifts a linkage arm allowing the ice to bypass the crusher blades. A motor and cam replace the ice cube solenoid.

Dispenser Light

The light bulb is a 6-watt 12 VDC bulb (WR02X10675). Check for 12 VDC at CN03 on the terminal board, between pin #4 and pin #5, with the dispenser switch in the closed position.

Water Valve and Water Tank

The water valve is mounted in the left section of the machine compartment.



The incoming water line is routed under the unit, up the back of the refrigerator cabinet, into the machine compartment, through the GWF water filter, and into the inlet of the water valve.

From the water valve, 2 low-pressure water lines independently supply water to the icemaker and water tank.

The icemaker water line is routed from the water valve, through the machine compartment, and to the icemaker fill tube. The water tank line is routed from the water valve, through the back of the machine compartment, down the back of the cabinet, through the bottom of the unit, and into the fresh food compartment where it is

attached to the water tank. The water tank holds approximately 35 oz of water. (4 QT)

The door dispenser supply line is routed from the cold water tank, through the bottom of the unit, and into the freezer door.

The dispenser valve (blue coil) delivers filtered water through the water tank to the freezer door dispenser. The coil has a resistance of approximately 325 ohms.

The icemaker valve (brown coil) delivers filtered water directly to the icemaker. The coil has a resistance of approximately 180 ohms.

The dispenser coil receives 120 VAC from CN08, between pin #2 (when **WATER** is selected) and CN08, pin #3 (neutral).

The icemaker coil receives 120 VAC from terminal block location CN08, between pin #1 (when the icemaker is calling for fill water) and CN08, pin #3 (neutral).

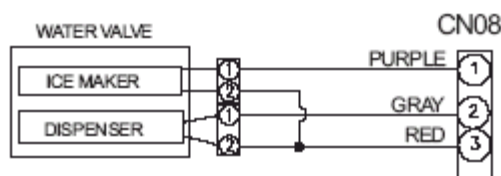

Note: The water filter should NOT be installed if the home has a water filtration system in place (reverse osmosis filter system, etc.) Replace the

To replace the water valve:

Note: Some water may leak from the water supply line and valve when they are disconnected.

1. Shut off the water supply to the unit.
2. Open the machine compartment and remove the grille panel.
3. Remove the single Phillips-head screw that holds the water valve in place.
4. Disconnect the wiring harness connector and 3 water lines from the water valve.

To replace the chilled water tank:

Note: Some water may leak from the water supply line and valve when they are disconnected.

1. Shut off the water supply to the unit.
2. Remove the 2 Phillips-head screws from the chilled water tank.
3. Cut the water lines leaving enough line to reconnect. Use 2 unions (5/16-in. x 5/16-in.), part

WR02X10471.

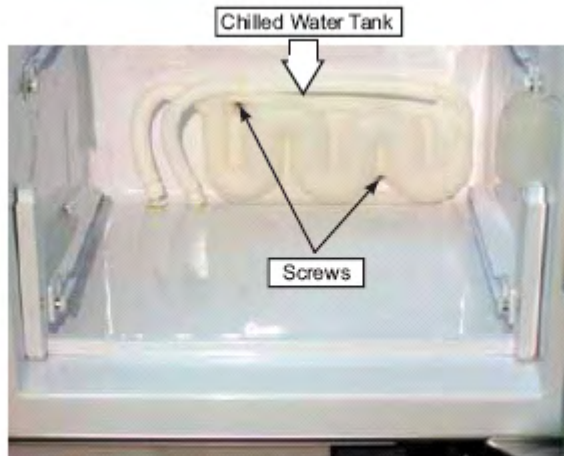

Approximate water temperature by the glass:

- Room Ambient at 76°F (24°C).
- 8-ounce glass.
- One-minute interval between dispensing water.

1st glass	53°F	12°C	5th glass	66°F	19°C
2nd glass	48°F	9°C	6th glass	69°F	21°C
3rd glass	52°F	11°C	7th glass	71°F	22°C
4th glass	57°F	14°C	8th glass	73°F	23°C

Duct Door Assembly

Duct Door

The dispenser control panel must be removed before removing the duct door.

Insert a fl at-blade screwdriver between the duct door (top right corner) and the switch housing. Use the screwdriver to slide the door to the left, until the hinge pin is free.



Duct Door Motor Switch Housing

The dispenser motor operates through 2 switches located in a housing at the top, right corner of the dispenser cavity. The dispenser motor switch housing is held in place by 4 Phillips-head screws.

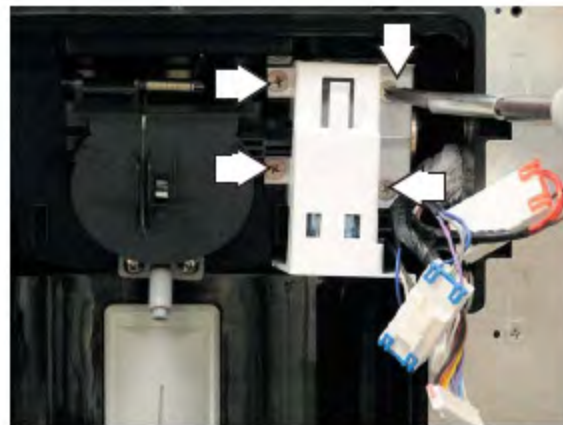

The duct door motor switches are held in place by 2 tabs.

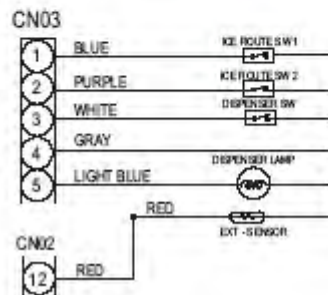

Duct Door Motor

The duct door motor rotates an eccentrically shaped plastic cam which operates the duct door.

To remove the duct door motor:

1. Manually rotate the motor cam until the cam lobe points forward.
2. Remove the 2 Phillips-head screws from the motor mounting bracket. (Photo shown with cam removed.)

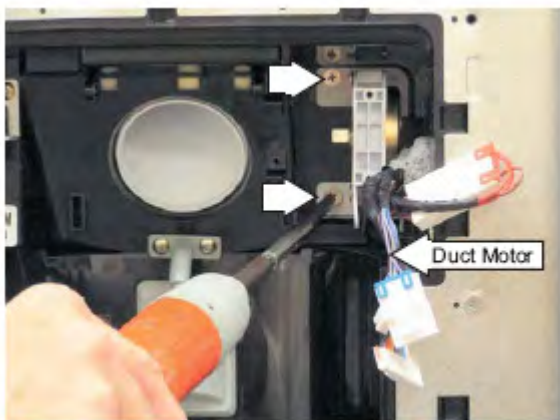

3. Slide motor assembly to the left to clear the rear mounting tabs.
4. Pull the motor forward while rotating it clockwise.
5. Disconnect the motor wire connector.

Caution: When assembling, ensure the duct door post is in the outer channel of the cam, to avoid damage to the duct door and/or cam.

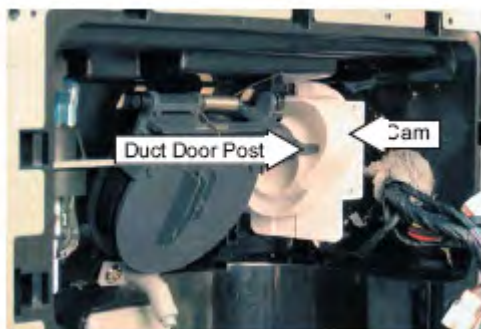

Caution: When installing the motor, ensure the motor mount is behind the side and bottom tabs, or damage to the cam will occur.

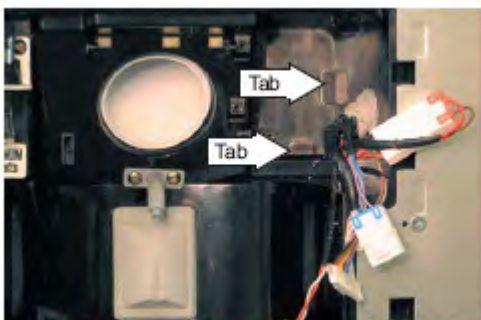

Note: Before reapplying power, remove the switch housing and rotate the motor cam clockwise by hand to ensure proper door/cam operation. To avoid motor gear

damage, DO NOT rotate the motor cam counterclockwise.

The duct door motor operates at 120 VAC when energized by the power control board (PCB). The motor has resistance of approximately 2K W. Check at CN08 on the terminal board, between pin # 4 (neutral) and pin # 6.

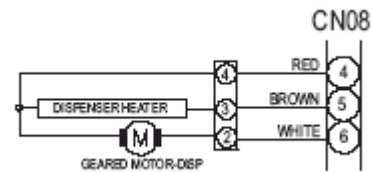

Dispenser Switch

The dispenser switch pad must be removed to access the dispenser switch. Insert a fl at-blade screwdriver into the bottom slot of the dispenser switch pad and lift up.

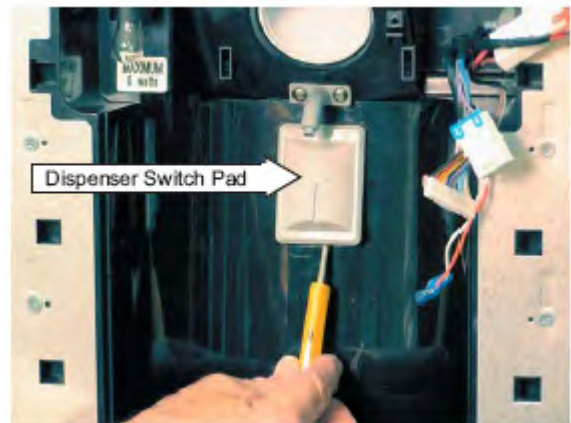

To remove the switch, lift it up at the bottom (see photo) with a screwdriver. Release the switch from the tabs at the top.



The switch is a normally open switch. Check for 5 VDC at CN03 on the terminal board, between pin #3 and pin #4, when the dispenser switch is open.

Dispenser Heater

The dispenser cavity heater is non serviceable. If defective, the freezer door must be replaced. The amount

of time the heater is energized is based on ambient temperature (provided by the ambient thermistor). Below 46°F (8°C), the heater is constantly on. Between 46°F (8°C) and 80°F (27°C), the heater cycles on and off with the compressor. Between 80°F (27°C) and 98°F (37°C), the heater cycles on for 5 minutes and off for 5 minutes, while the compressor is running. When the compressor is off, the heater cycles on for 5 minutes and off for 25 minutes. Above 98°F (37°C), the heater cycles on and off, with the compressor. Check for 120 VAC at CN08 on the terminal block, between pin #4 and pin #5, when the heater should be energized or when the refrigerator is in test mode **0 9** (see *Service Diagnostics*). Heater resistance is approximately 1.9K

Door Water Line Replacement

To remove the existing water line, remove the screws from the water line retainer at the dispenser, then pull the retainer off the tubing. From the bottom of the door, disconnect the water line and pull it down and out. To install the new water line, soak the new line in hot water (to make it pliable) and insert it into the door at the dispenser location. Feed the water line into the door, until it emerges through the bottom hinge as shown in the photo below. (The stainless steel panel is shown pulled away from the door for clarity).



Note: On custom panel models, it may be necessary to remove the door handle and slide the panel to the right to feed the water line past the bend.

Main Switch

The main switch is mounted to a bracket at the front of the machine compartment. The main switch opens both the line voltage and neutral side to the refrigerator.

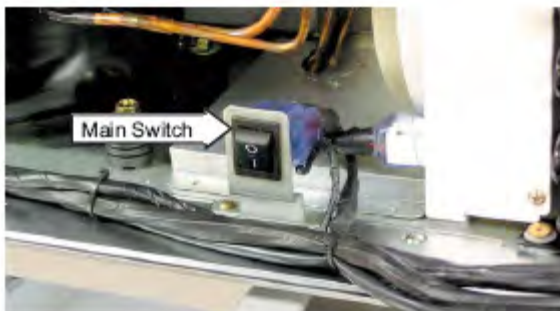

When the refrigerator is plugged in, the line voltage and neutral is supplied at CN01, between pin #1 and pin #2.

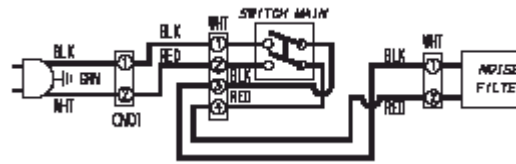

Caution: Do NOT connect or disconnect CN1 connector with power applied. Always turn off power at the main switch to avoid arcing at connector terminals.

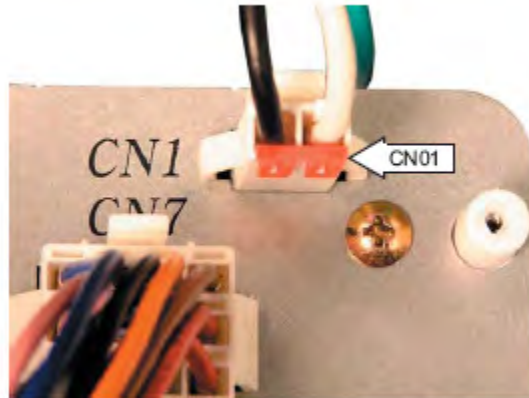

Note: If the refrigerator is dead (no lights or component operation), check for power to CN1. Ensure the main switch is operating correctly. Check for loose connectors at the terminal block.

To check power to the main switch, check for 120 VAC between the black and red wires on the connector shown below.

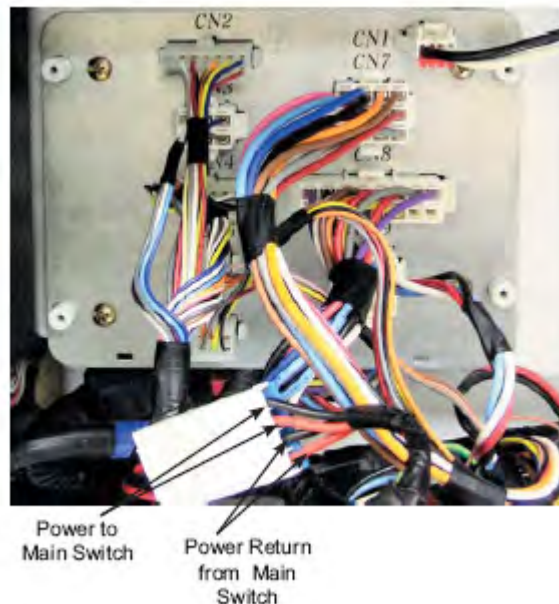

Compressor

The refrigerator contains a variable speed inverter compressor (2200 to 3800 RPM). The inverter is part of the main power control board (PCB). The compressor will start (if required) one minute after power is applied to the refrigerator. Compressor operation is determined by the fresh food and freezer thermistors.

Should the compressor fail to start when required, check the compressor windings and associated wiring harness BEFORE checking for a power control board (PCB) problem. The compressor resistance between each pin should be approximately 12 Ohms. Measure the resistance at CN08, between pin #7 (black wire), pin #8 (purple wire), and pin #16 (blue wire).

A thermal overload, designed to protect the compressor, is mounted within the compressor terminal cover. The overload will open at 257°F (125°C) and close at 156°F (69°C). The overload should be checked at CN08, between the pin #14 and pin #15 (light blue wires).

Note: An open compressor overload will prevent the main control board from operating. If voltage is present at CN01, and the refrigerator is dead (except for the interior lights), check to make certain the thermal overload is closed.

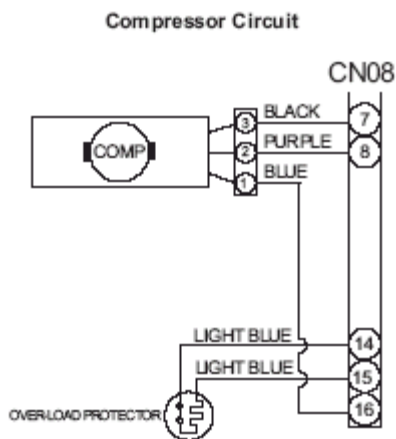

Refrigerant Charge

The refrigerant used in the sealed system is R134a. Proper system charge is 8.11 oz.

Refrigerant Charge

Heat Exchanger

The heat exchanger is located at the rear of the machine compartment, behind the compressor. The tubing is coiled and foamed into a galvanized cover. A replacement heat exchanger and cover come as a complete assembly.



Shown with Cover Cut Open



Mufflers

The sealed system has 2 mufflers to reduce noise, one in the suction line and one in the compressor discharge line.

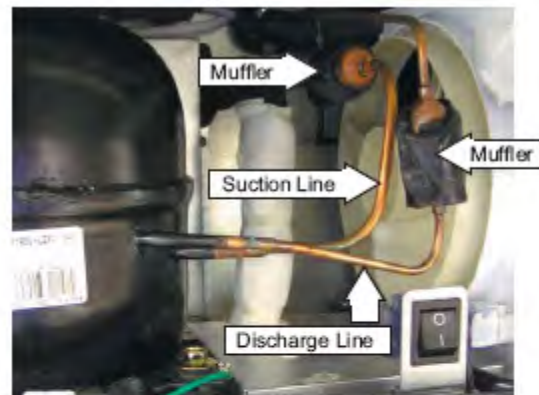

Mufflers Cross-Cut View



Drier

The drier is positioned vertically in the center of the machine compartment. A short jumper tube runs from the drier to the 3-way valve behind it. The standard replacement drier is WR86X93. Use the filter drier WR86X96 if the system has been contaminated.

Note: When the compressor first cycles off, the drier surface may have moisture beads and feel cold to the touch. This is normal due to the refrigerant equalizing through the evaporators.

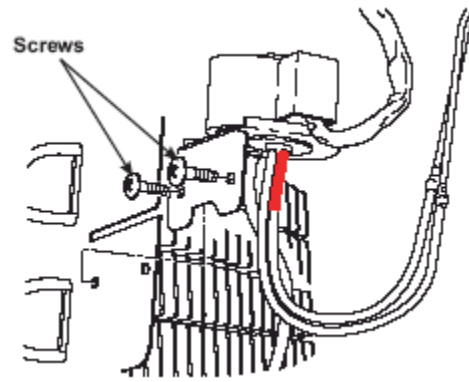
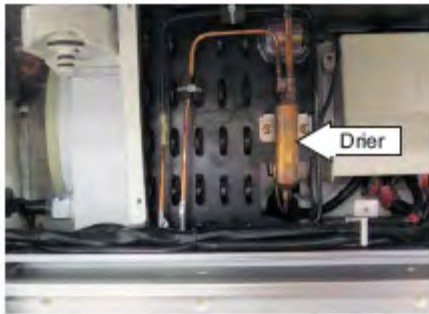

The valve is composed of a magnetic coil and valve body.

3-Way Valve

The 3-way valve directs the refrigerant flow to the two evaporators as needed, and is controlled by the power control board (PCB). It is located on the right side of the compartment.

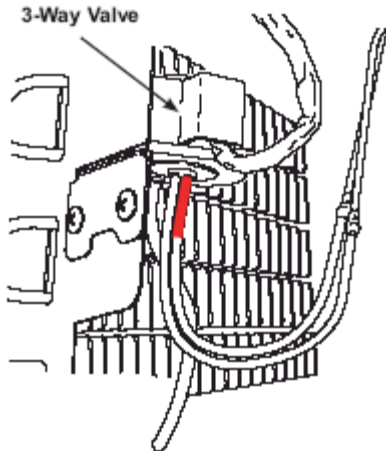

The 3-way valve is held in place by 2 Phillipshead screws.

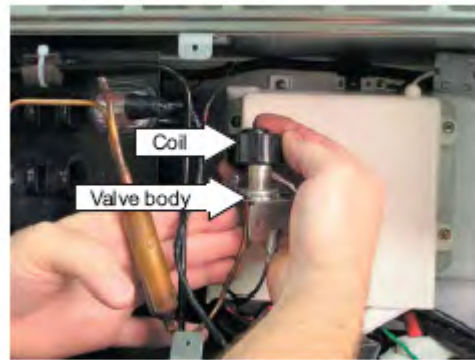

Testing

To test whether the 3-way valve is receiving a signal from the power control board:

1. Turn the power OFF at the main switch for at least 10 seconds.
2. Place a finger on top of the valve.

Caution: Be careful of the condenser fan and any exposed wires.

3. Turn the main switch back on. You should feel movement, and you may hear the 3-way valve move to the home position.
4. If movement is detected, the power control board and valve coil should be OK.

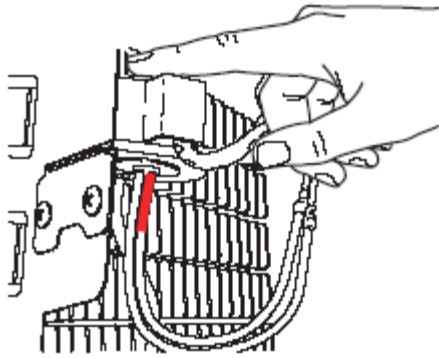

Check for proper resistance of the valve coil windings at the coil harness.

Orange - Gray = 40 W

Blue - Gray = 40 W

Orange - Blue = 80 W

Gray - Black = 40 W

Gray - Yellow = 40 W

CN02

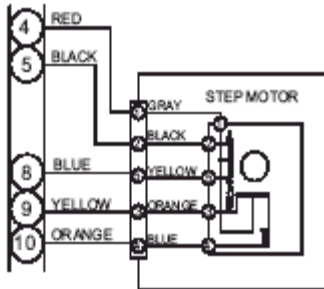

Replacement

When replacing the 3-way valve, note the red sleeve on the valve tube. This tube connects to the freezer capillary. The corresponding freezer capillary has red paint above the b

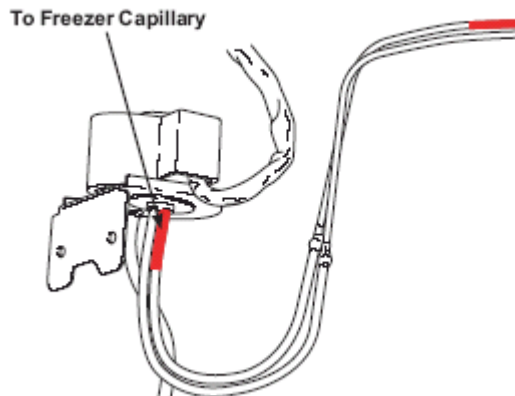

The 3-way valve is extremely sensitive to heat. When brazing, thoroughly cover the valve base with heat absorbing paste (part # WR5X8927). Make certain to direct the flame away from the valve body.

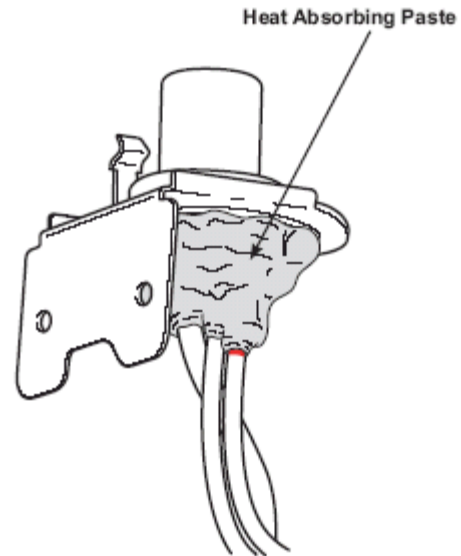

Door Switches

The refrigerator is equipped with an AC and a DC switch above each door. The switches are located inside the machine compartment.

Freezer Door



Fresh Food Door

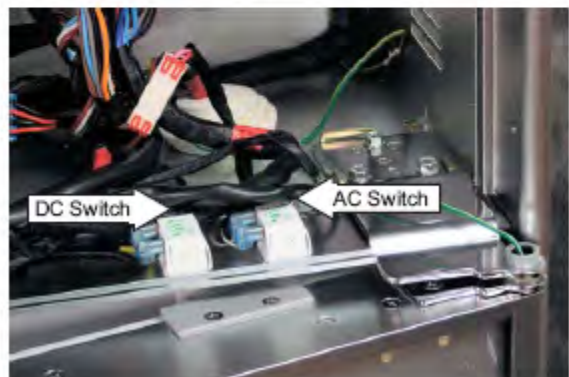

The AC switch, above the freezer door, controls the freezer interior lights and the auger motor operation. The freezer light is switched through the neutral side of the line.

The AC switch, above the fresh food door, controls the fresh food interior lights.

AC DOOR SWITCHES

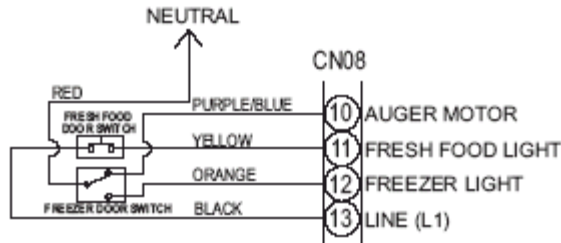

The DC switches provide “door open” information to the power control board (PCB).

Note: The fans turn off when the doors are opened (DC door switches control operation) and delay 10 seconds before restarting when the doors are closed again. The freezer door switch controls only the freezer fan. The fresh food door switch controls both the fresh food and freezer fan operation.

DC DOOR SWITCHES

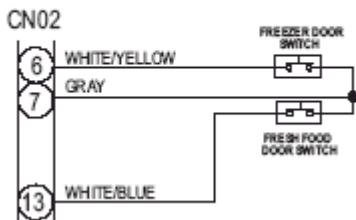

Interior Lights

Both the fresh food and freezer interior lights use 120 VAC, 40-watt incandescent bulbs. There are 4 bulbs (160 watts) in the fresh food section, and 2 bulbs (80 watts) in the freezer section.

Freezer bulb voltage is checked at CN07 on the terminal block. Test for voltage between pin #9 and pin #10.

Note: Pin #10 is only at neutral when the freezer door AC switch has closed contacts (door open). Fresh food bulb voltage is checked at CN09 on the terminal block. Test for voltage between pin #4 (neutral) and pin #3.

Note: Pin #3 is only at line voltage (120 VAC) when the fresh food AC door switch has closed contacts (door

open).

WARNING: The center terminal of the freezer light socket is energized whenever the refrigerator is plugged in and the main switch is closed, regardless of door position.

Thermistors

The main control board uses input from 5 thermistors:

- Ambient
- Freezer
- Fresh Food
- Freezer Evaporator
- Fresh Food Evaporator

The thermistors have a negative coefficient. As the temperature increases, the thermistor’s resistance decreases.

Testing

The most accurate method of testing a thermistor is to place it in a glass of ice water for several minutes. The thermistor should read approximately 13K W in the glass of 33°F ice water.



Note: Thermistors can also be checked for an open or shorted condition by using the diagnostic mode (see *Service Diagnostics*).

Ambient Thermistor

The ambient thermistor measures room temperature and is clipped to the back of the dispenser cover. Check for thermistor resistance (see *Thermistor Chart*) by disconnecting the harness at CN03 and testing between pin #4 (gray wire) and pin #6 (red wire) on the harness.

Freezer Air Thermistor

The freezer air thermistor is clipped to the inside of the evaporator cover.

Check for thermistor resistance (see *Thermistor Chart*) by disconnecting the harness at CN06 and testing between pin #3 (gray wire) and pin #5 (brown wire) on the harness.

Fresh Food Air Thermistor

The fresh food air thermistor is clipped to the inside of the ceiling cover. Check for thermistor resistance (see

Thermistor Chart) by disconnecting the harness at CN05 and testing between pin #2 (gray wire) and pin #3 (yellow wire) on the harness.

Freezer Evaporator Thermistor

The evaporator thermistor is mounted in a copper sleeve on the top, right corner of the evaporator. Check for thermistor resistance (see **Thermistor Chart**) by disconnecting the harness from CN06 and testing between the pin #3 (gray wire) and pin #6 (red wire) on the harness.

Fresh Food Evaporator Thermistor

The fresh food evaporator thermistor is mounted in a sleeve on the left side of the evaporator. Check for thermistor resistance (see **Thermistor Chart**) by disconnecting the harness at CN05 and testing between pin #2 (gray wire) and pin #4 (pink wire) on the harness.

Thermistor Chart

°F	Resistance In Ohms (KΩ)	°C
-9	37K	-23
-6	34K	-21
0	29K	-18
6	25K	-14
32	13K	0
37	12K	3
50	8.8K	10
77	5K	25
86	4.2K	30
95	3.5K	35

Thermistor Emergency Operation

If the freezer thermistor opens (or shorts), the unit defaults to the freezer evaporator thermistor. The compressor and freezer fan cycle off when the freezer evaporator temperature is -22°F (-30°C) or colder. The compressor and freezer fan cycle on when the freezer evaporator temperature is -2°F (-19°C) or warmer.

If the fresh food thermistor opens (or shorts), the fresh food cooling operation defaults to the freezer thermistor. Refrigerant will flow through the fresh food evaporator any time the freezer evaporator is cooling. The fresh food fan will cycle off once the fresh food evaporator thermistor reaches 5°F (-15°C) or colder.

Defrost Cycles

The refrigerator incorporates two different methods of defrost. Once the compressor has accumulated 2 hours of compressor run time, and certain conditions are satisfied, the fresh food evaporator goes through a “natural defrost” cycle. In addition, at a specific time interval, both the fresh food and freezer evaporators go through a “heated defrost” cycle.

Natural Defrost (Fresh Food Only)

Once the fresh food temperature is satisfied, natural defrost occurs on the fresh food evaporator, if the following conditions have been met:

- The compressor has accumulated 2 hours of run time.
- The ambient room temperature is above 66°F (19°C).
- The freezer temperature is satisfied.

If the above conditions have been met, when the fresh food temperature is satisfied, and the compressor cycles off, the 3-way valve will open to both the fresh food and freezer evaporators. This allows the refrigerant within the system to equalize back through the evaporators. This warm thermal mass (refrigerant) flowing through the evaporators helps to remove any frost buildup on the fresh food evaporator (it has very little impact on the freezer evaporator due to the freezer temperature). In addition, when the fresh food evaporator thermistor is below 23°F (-5°C), the fresh food evaporator fan will run to help move air across the evaporator. Once the thermistor reaches 28°F (-2°C), the fan will cycle off.

Note: If the compressor is still cooling the freezer section when the fresh food cycles off, or the ambient room temperature is below 66°F (19°C), natural defrost will not occur.

Heated Defrost

In normal cooling operation (normal food load, door openings, etc.), the power control board (PCB) will energize the fresh food defrost heater every 5 hours of compressor running time and the freezer defrost heater every 10 hours of compressor running time. For example, after approximately 10 accumulated hours of compressor running time, the freezer evaporator will have gone through one defrost cycle, and the fresh food evaporator will have gone through two defrost cycles.

The fresh food heater cycles off when the fresh food evaporator thermistor reaches 63°F (17°C). The freezer heater cycles off when the freezer evaporator thermistor reaches 68°F (20°C). The compressor and fans do not

operate when either section is defrosting, regardless of the cabinet temperature. There is a 10-minute dwell period after the heater cycles off.

Note: Upon initial power-up, the fresh food and freezer go into heated defrost simultaneously, after 4 hours of accumulated compressor run time.

During unusual cooling situations where there are no door openings (such as vacations), the time between heated defrost cycles may increase. If the ambient room temperature is above 82°F (28°C) and there are no door openings, the fresh food defrost occurs every 8 hours, and the freezer defrost occurs every 16 hours. If the ambient room temperature is below 82°F (28°C), defrost occurs at the normal intervals – fresh food defrost every 5 hours and freezer defrost every 10 hours of accumulated compressor run time.

Thermistor Error Defrost Operation

If either evaporator thermistor fails (open or shorted), the power control board (PCB) defaults to a timed defrost cycle based on cabinet temperature.

If the freezer evaporator thermistor fails (open or shorted) and the freezer temperature is below 27°F (-3°C), the freezer defrost heater will be energized for 20 minutes. If the freezer temperature is above 27°F (-3°C), the heater will not come on.

If the fresh food evaporator thermistor fails (open or shorted) and the fresh food temperature is below 68°F (20°C), the fresh food defrost heater will be energized for 10 minutes. If the fresh food temperature is above 68°F (20°C), the heater will not come on.

During thermistor error operation, the control defaults to fresh food defrost every 5 hours and freezer defrost every 10 hours of accumulated compressor run time.

Fans

All 3 fans (condenser, freezer, and fresh food) are variable-speed DC fans. The speed of each fan is controlled by an algorithm in the power control board (PCB) and determined by many factors, such as room ambient, thermal load, temperature settings, number of door openings, etc. The fans are extremely QUIET, and determining fan speed is very difficult. As a general rule, if the voltage measured at the fan is within limits and airflow is felt through the vents, assume the fans are working correctly.

Note: The fans will run on a 9-volt battery for testing purposes. Use the two higher voltage pins as described in the following procedures.

Freezer Evaporator Fan

The freezer fan assembly is mounted directly to the freezer evaporator. The fan assembly (motor, blower and housing) is available as a separate part or complete and preassembled on a new freezer evaporator.

Operation of the freezer fan is also affected by room temperature. If the ambient thermistor senses a temperature of 82°F (28°C) or higher, the freezer fan will delay 5 minutes (after the compressor has started) before starting and circulating the freezer air. Below 82°F (28°C), the fan will start immediately with the compressor.

The freezer evaporator fan motor supply voltage can be checked at CN06 on the terminal block.

When the power control board (PCB) is energizing the fan, check for approximately 8 to 11 VDC at CN06, between pin #2 and pin #3, and approximately 2.25 VDC, between pin #1 and pin #3.

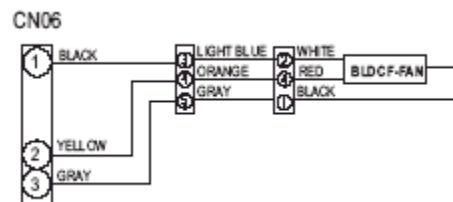

Fresh Food Evaporator Fan

The fresh food fan assembly is mounted directly to the fresh food evaporator. The fan assembly (motor, blower, and housing) is available as a separate part or complete and preassembled on a new fresh food evaporator.

The fresh food evaporator fan motor supply voltage can be checked at CN05 on the terminal block. When the power control board (PCB) is energizing the fan, check for approximately 7 to 8 VDC between pin #2 and pin #6, and approximately 2 VDC between pin #2 and pin #5 at CN05.

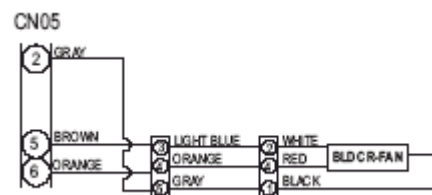

Condenser Fan Assembly

Ambient temperature affects the operation of the condenser fan. If the room temperature is less than 45°F (7°C), the condenser fan will not run when the

compressor is on. If the temperature is between 45°F (7°C) and 50°F (10°C), the fan will start 5 minutes after the compressor has started. Above 50°F (10°C) (or if the ambient thermistor is open or shorted), the condenser fan is synchronized with the compressor.



The condenser fan assembly is held in place by 2 Phillips-head screws at the front and 2 tabs at the rear. The 2 tabs are inserted into the rear condenser mounting plate. The 2 front screws attach the shroud assembly to the front condenser plate. (See photo below.)

Shown with Condenser Fan Assembly Removed

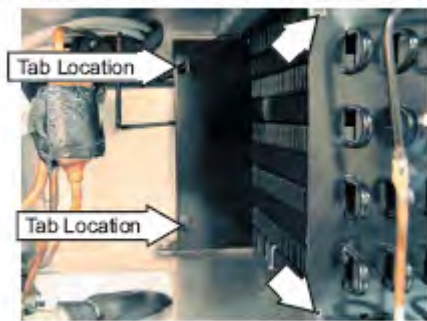

The 3-bladed fan can be removed without removing the complete fan assembly.

The fan rotates counterclockwise as viewed from the motor shaft end. It is held in place by a spring retention clip.



To remove the condenser fan assembly:

1. Remove the water filter cartridge.
2. Remove the 2 Phillips-head screws from the water filter receptacle.

3. Remove the 2 Phillips-head screws from the front of the shroud assembly and disconnect the fan wiring.
4. Bend the 2 wire retention tabs back to release the wire harness.
5. Pull the fan forward and tilt it to the left to release the 2 water filter tubes from the channel at the top of the condenser fan motor shroud.

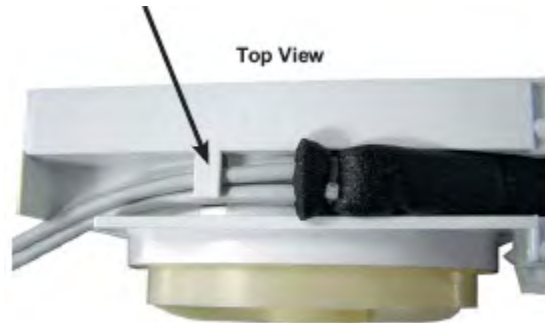

6. Pull the cabinet wiring down as shown in the photo below. Carefully pull the condenser fan assembly out of the machine compartment.

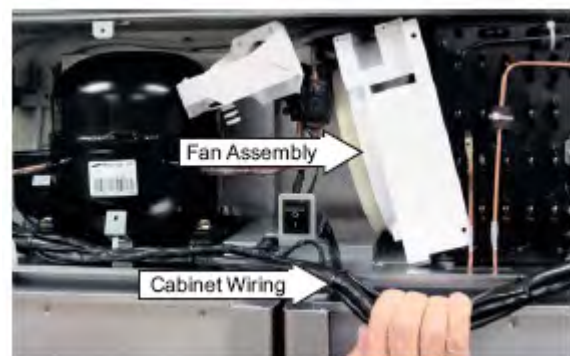

Installing the condenser fan assembly:

1. Secure the wires to the condenser fan shroud to prevent interference with the fan blade rotation.
2. Ensure the rubber tab covers are in place when reinstalling the condenser fan assembly.

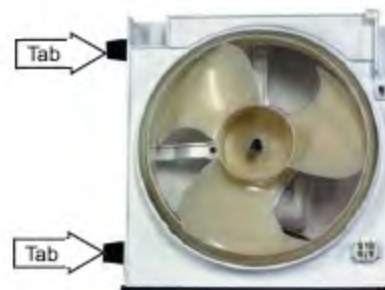

3. Ensure water filter lines are fully seated into the top channel of the water filter housing bracket.

Voltage Checks

When the power control board (PCB) is energizing the fan, check for approximately 9 to 10 VDC between pin #2 and pin #3 at CN02 on the terminal block. Check for approximately 2 VDC between pin #1 and pin #3 at CN02.

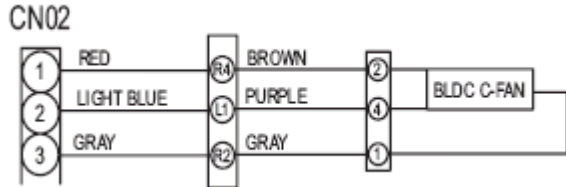

Fresh Food Heater Testing

The fresh food evaporator defrost heater, evaporator drain pan heater, and icemaker fill tube heater are in a parallel circuit. The heaters are in series with the bimetal defrost safety thermostat.

Check for a combined resistance of 91 W at CN09 on the terminal block, between pin #1 and pin #2, when the defrost safety thermostat is closed. When the fresh food is in the defrost test mode 1 4 (see *Service Diagnostics*) check for 120 VAC at CN09 on the terminal block, between pin #1 and pin #2.

Note: Access to the evaporator is necessary to complete testing of the above components, with exception of the icemaker fill tube heater.

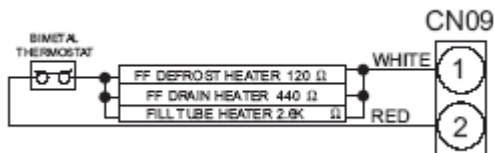

- The resistance value of the defrost heater is approximately 120 Ohm.
- The resistance value of the drain pan heater is approximately 440 Ohm.
- The resistance value of the icemaker fill tube heater (referred to as the “PIPE HEATER ICE WATER” on some schematics) is approximately 2.6K Ohm.
- The defrost safety thermostat is a bimetal type which will open at 140°F (60°C) and will reset at 104°F (40°C)

Freezer Heater Testing

The freezer evaporator defrost heater, suction line drain pan heater, and the evaporator drain pan/drain tube heater are in a parallel circuit. The heaters are in series with the bimetal defrost safety thermostat.

Check for a combined resistance of approximately 38 Ohm at CN07, on the terminal block, between pin #1 and pin #2.

When the freezer is in defrost test mode 1 4 (see *Service Diagnostics*), check for supply voltage of 120 VAC at CN07 on the terminal block, between pin #1 and pin #2.

Note: Access to the evaporator is necessary to complete testing of the above components, with the exception of the suction line drain pan heater.

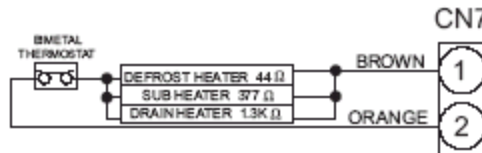

- The resistance value of the defrost heater is approximately 44 Ohm.
- The resistance of the suction line drain pan heater (referred to as the “DRAIN HEATER” on some schematics) is approximately 1.3K Ω.
- The resistance value of the evaporator drain pan and drain tube heater (referred to as the “SUB HEATER” on some schematics) is approximately 377 Ohm!
- The defrost safety thermostat is a bimetal type which will open at 140°F (60°C) and will reset at 104°F (40°C).

Freezer Evaporator Assembly

The freezer evaporator assembly consists of an evaporator, defrost and drain heaters, defrost safety thermostat, thermistor, and fan assembly. All the parts are available as a complete replacement assembly, or the components are available individually.

All components are housed together and installed in a recessed compartment in the freezer ceiling.

To access the freezer evaporator assembly:

1. Remove the ice container shelf, then remove the icemaker.
2. Remove 4 Phillips-head screws that hold the top air duct cover in place.



- Remove auger motor and cube motor connectors from the freezer evaporator cover.
- Remove the 2 Phillips-head screws that hold the rear air duct cover in place, then pull it down.

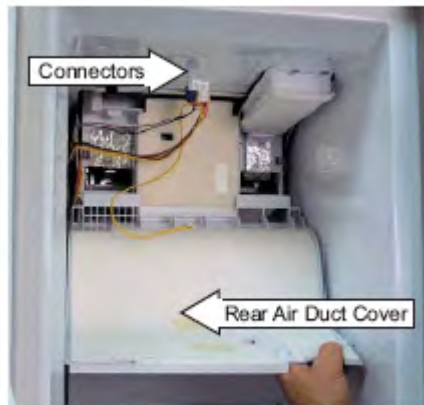

- Disconnect all the electrical connectors from the ceiling.
- Remove the rear air duct cover.
- Remove the 2 Phillips-head screws from the suction line drain pan and heater assembly. Disconnect the associated wiring.

Note: The suction line drain pan heater has a resistance value of 1.3K Ohm.



- Carefully remove the styrofoam air duct.

Note: The styrofoam air duct is held in place by adhesive.

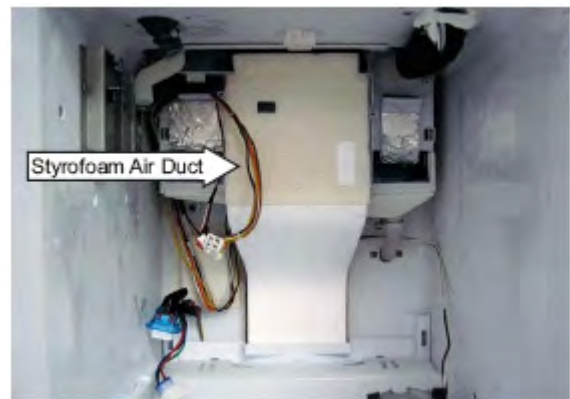

- Remove the 2 Phillips-head screws that hold the freezer plug cover in place, then remove the freezer plug cover. Freezer Plug Cover

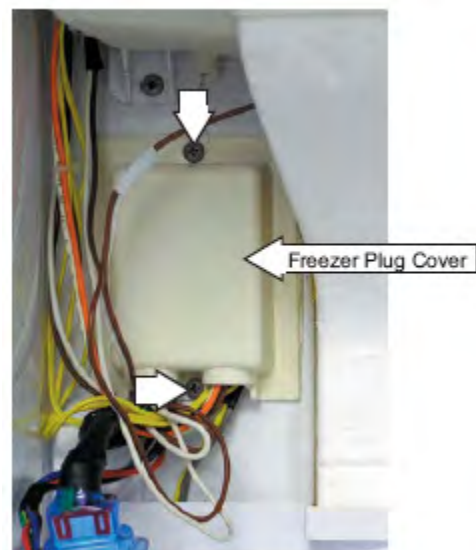

- Disconnect the freezer evaporator wiring.



Note: When installing plug cover, place wiring connectors inside the cover, then mount the plug cover to the wall.

- Remove the 2 Phillips-head screws that hold the freezer evaporator assembly housing in place.

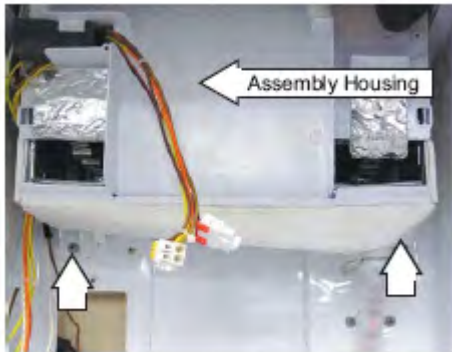

- Lower the evaporator assembly into the freezer compartment.



- Place the freezer shelf in the top position. Place the evaporator assembly on the shelf.

Caution: Refrigerant lines may be damaged if the evaporator assembly is left unsupported.

Freezer Evaporator Fan Assembly

The freezer evaporator fan assembly consists of a 2-speed DC fan motor, blower wheel, and housing. It is mounted on top of the evaporator.

To remove the freezer evaporator fan assembly:

- Access the freezer evaporator assembly. (See *Freezer Evaporator Assembly*.)
- To access the fan assembly screws, support the evaporator assembly from the machine compartment grille mounting bracket with a bent wire hook (see photo).
- Remove the 4 Phillips-head screws that hold the evaporator fan assembly in place. Remove the evaporator fan assembly. Evaporator Assembly

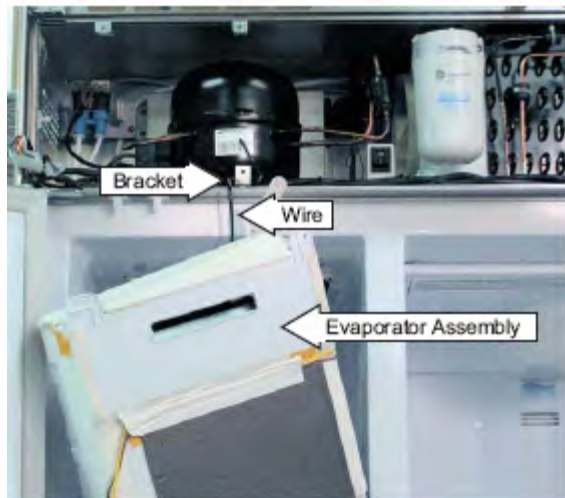

Note: When installing the fan assembly, ensure that the housing lip inserts into the channel.



Freezer Evaporator

To access the freezer evaporator:

- Access the freezer evaporator assembly. (See *Freezer Evaporator Assembly*.)
- Remove the freezer evaporator fan assembly. (See *Freezer Evaporator Fan Assembly*.)
- Place the freezer shelf in the top position. Place the evaporator assembly on the

shelf. (Note the position of all wiring prior to disassembly.)

4. Starting at one corner, use a screwdriver and unlock the 6 tabs from the housing cover.



WARNING: The evaporator fins are very sharp. Wear Kevlar gloves when handling.

5. Remove the single Phillips-head screw at the corner of the evaporator.

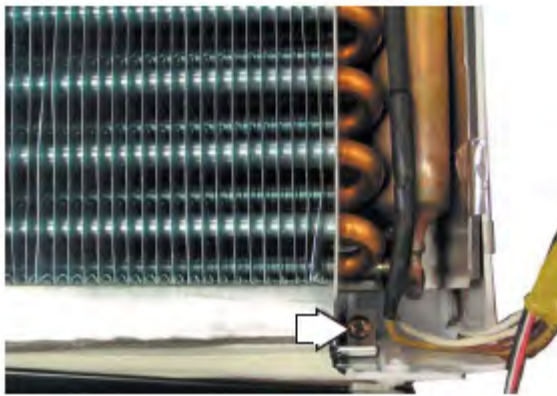

6. To access the remaining Phillips-head screw that holds the evaporator in place, suspend the evaporator from the machine compartment grille mounting bracket with a bent wire hook. Remove the screw.

Note: The screw may be covered by foil.



7. Lift the evaporator from the housing.



Freezer Evaporator Components

To access the freezer evaporator components:

1. Access the freezer evaporator assembly. (See *Freezer Evaporator Assembly*.)
2. Remove the freezer evaporator fan assembly. (See *Freezer Evaporator Fan Assembly*.)
3. Access the freezer evaporator. (See *Freezer Evaporator*.)

Defrost Safety Thermostat

To remove the defrost safety thermostat, remove the single Phillips-head screw from the thermostat mounting bracket. Separate the thermostat from the bracket.

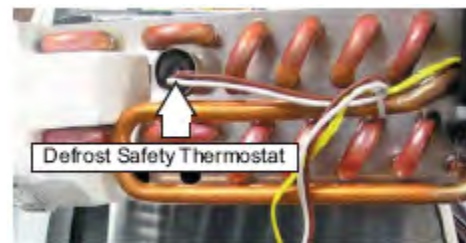

Freezer Evaporator Thermistor

To remove the freezer evaporator thermistor, pull it straight out from its mounting tube.



Defrost Heater

To remove the defrost heater, remove the 2 Phillips-head screws from the evaporator defrost heater mounting brackets. Separate the defrost heater from the evaporator.

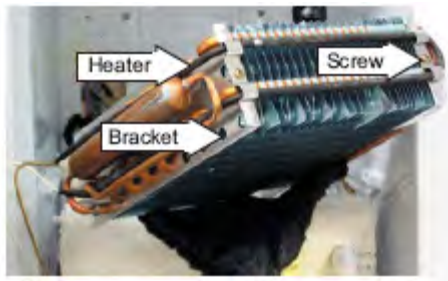

Fresh Food Evaporator Assembly

The fresh food evaporator assembly consists of an evaporator, defrost and drain heaters, bimetal defrost safety thermostat, thermistor, and evaporator fan assembly.

All components are housed together and installed in the refrigerator interior in a recessed compartment in the refrigerator ceiling. This compartment extends vertically into the machine compartment.

To access the fresh food evaporator assembly:

1. Remove the fresh food grille cover by inserting a flat blade screwdriver into the slot (see photo) and lifting up.



2. Remove 4 Phillips-head screws from the fresh food air duct cover. Pull the front of the cover down.
3. Disconnect the thermistor and lighting connector. Remove the fresh food air duct cover.

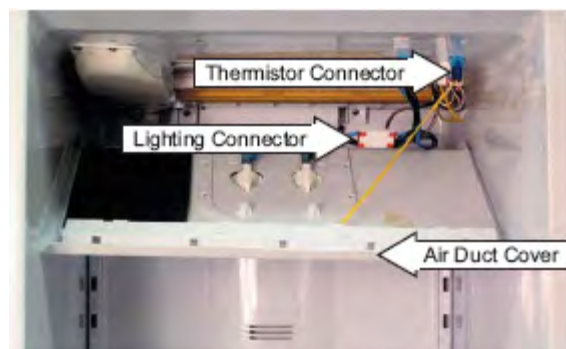

4. Remove the 4 Phillips-head screws that hold the refrigerator suction line drain assembly in place. Remove the assembly.

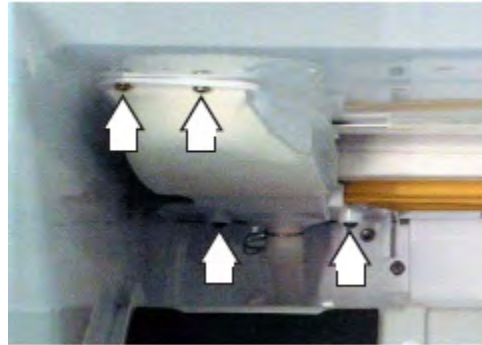

5. Remove the 2 Phillips-head screws that hold the fresh food upper duct cover assembly in place. Remove the upper duct cover.



6. Disconnect the remaining electrical connectors.
7. Remove 2 Phillips-head screws from the fresh food evaporator housing.

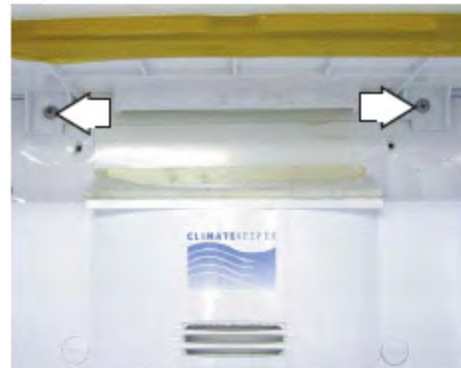

8. Lower the evaporator assembly into the fresh food compartment.



9. Place the fresh food shelf in the top position. Place the evaporator assembly on the shelf.



Caution: Refrigerant lines may be damaged if the evaporator assembly is left unsupported.

Fresh Food Evaporator Fan Assembly

To remove the fresh food evaporator fan assembly:

1. Access the fresh food evaporator assembly. (See *Fresh Food Evaporator Assembly*).
2. The fan assembly is attached to the evaporator assembly with 4 Phillips-head screws (2 on each side of the fan assembly). Remove the 4 screws that hold the fan assembly in place.
3. Separate the fan assembly from the evaporator assembly.

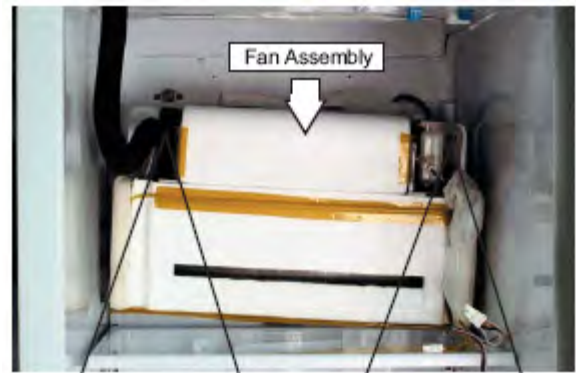

Fresh Food Evaporator

To access the fresh food evaporator:

1. Access the fresh food evaporator assembly. (See *Fresh Food Evaporator Assembly*.)
2. Remove the fresh food evaporator fan assembly. (See *Fresh Food Evaporator Fan Assembly*.)
3. Remove the tape from the front of the Styrofoam cover. Note the position of the wires under the tape. The tape must be replaced after repair.
4. Remove the Styrofoam cover.

WARNING: The evaporator fins are very sharp. Wear Kevlar gloves when handling.

5. Remove the 2 Phillips-head screws that hold the fresh food evaporator in place (Fig. 1 and Fig. 2)
6. Disconnect the 2 electrical connectors and lift the fresh food evaporator from the housing.

WARNING: The evaporator fins are very sharp. Wear Kevlar gloves when handling.

Fig. 1

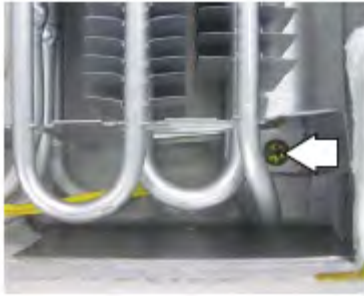
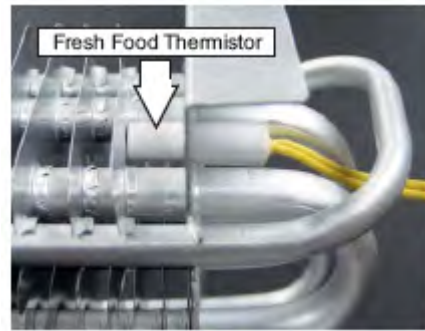
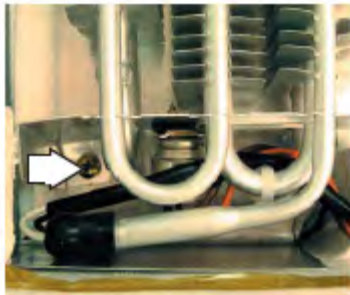

Fig. 2



Replacing the Freezer or Fresh Food Evaporator

The freezer evaporator can be replaced as a complete unit, including the defrost components and fan assembly, or it can be replaced as an individual component.

The fresh food evaporator can be replaced as a complete unit or as an assembly consisting of the evaporator and defrost heater (the fresh food defrost heater is not available separately).

To replace the freezer or fresh food evaporator:

1. Access the specific evaporator as described in *Fresh Food Evaporator Assembly* or *Freezer Evaporator Assembly*.
2. In the machine compartment, remove the screws that hold the main switch in place. Move the main switch out of the way to provide better access to the evaporator tubing.

Fresh Food Evaporator Components

To access the fresh food evaporator components:

1. Access the fresh food evaporator assembly. (See *Fresh Food Evaporator Assembly*.)
2. Remove the fresh food evaporator fan assembly. (See *Fresh Food Evaporator Fan Assembly*.)
3. Access the fresh food evaporator. (See *Fresh Food Evaporator*.)

Defrost Safety Thermostat

To remove the defrost safety thermostat, remove the single Phillips-head screw from the thermostat mounting bracket. Separate the defrost thermostat from the bracket.



Fresh Food Evaporator Thermistor

To remove the fresh food evaporator thermistor, pull it straight out from its mounting tube.

Note: The defrost heater is not available separately and only comes as a part of the evaporator assembly.

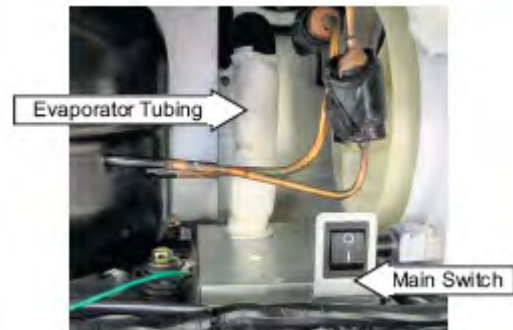

3. Remove the condenser fan assembly from the compartment. (See *Fans*.)
4. Remove the 5 Phillips-head screws holding the metal cover over the Styrofoam block (see photo below). Remove the metal cover.
5. Remove the Styrofoam block from the base of the evaporator tubing.

Note: Adhesive may be holding the Styrofoam block in place after the metal cover is removed.



6. Carefully cut and remove the insulation on the suction line and capillary tubing to expose the solder joints.

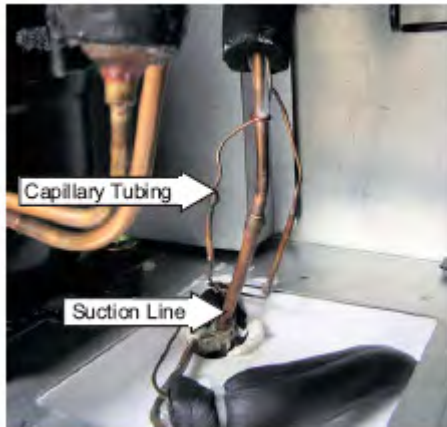

Note: Save the insulation to rewrap the refrigerant tubing after brazing.

7. Recover the refrigerant. (See *Evacuation and Charging Procedures*).

8. Disconnect the suction line and capillary of the specific evaporator to be replaced. Note the position of the tubing within the machine compartment. Pull the evaporator tubing down from the cabinet and remove the evaporator.

9. Install the new evaporator and carefully bend the tubing to the correct position. Braze the suction line and capillary tubing.

10. Replace the drier (part # WR86X93) and install a process valve (part # WJ56X61) at the compressor.

11. Reinstall the remaining components within the cabinet section while the braze joints are cooling.

12. Charge the system with the exact amount of refrigerant (8.11 oz.) specified on the rating plate

13. Check for refrigerant leaks at all joints.

14. Reinstall insulation around the tubing. Wrap with tape to provide a good airtight seal.

15. Reinstall Styrofoam block and metal cover.

16. Check refrigerator for proper operation.

Service Diagnostics

Diagnostic Mode

1. To enter the diagnostic mode, the temperature display must be lit up. If the temperature display is not lit, press any pad on the overlay.

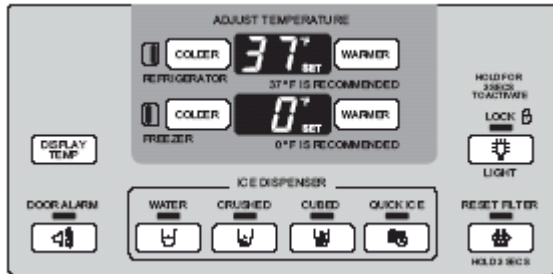

2. Press the 2 **COLDER** and 2 **WARMER** pads simultaneously for three seconds. The **FREEZER** and **REFRIGERATOR** displays will change to **0 0**.

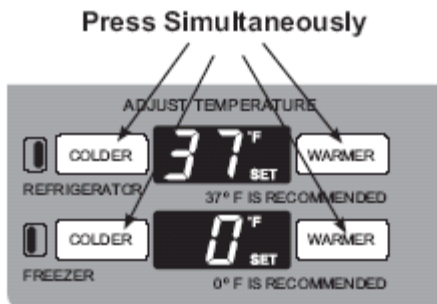

3. To select a test mode:
 - a. Enter a numeric value (see *Test Mode Chart*) on the **FREEZER** display using the **COLDER** or **WARMER** pad.

Note: The **COLDER** pad decreases the numeric value. The **WARMER** pad increases the numeric value.

 - b. Enter a numeric value (see *Test Mode Chart*) on the **REFRIGERATOR** display using the **COLDER** or **WARMER** pad.

4. Once the displays indicate a test mode, press any pad on the temperature board overlay, other than the **COLDER** or **WARMER** pads, to enter that mode.

Note: A test mode must be selected within 30 seconds of entering the diagnostic mode or it will time out, normal refrigerator operation will resume, and the displays will turn off. Once a test mode is selected, the display will flash to confirm the mode selected.

5. At the end of a test session, to exit the diagnostic mode, do one of the following:
 - Enter **1** on the **FREEZER** display and **5** on the **REFRIGERATOR** display. Press any pad other than the **COLDER** or **WARMER** pads to execute a system restart.
 - Enter **1** on the **FREEZER** display and **6** on the **REFRIGERATOR** display. Press any pad other than the **COLDER** or **WARMER** pads to exit the service diagnostic test mode.
 - Recycle power to the unit through the main switch. As a cautionary measure, the system will automatically time out of the diagnostic mode after 15 minutes of inactivity. In the diagnostics mode, the unit can be tested under different conditions.

Test Mode Chart

FZ Display	FF Display	Mode	Comments
0	1	Showroom Mode	See Note #1.
0	2	Do Not Use	
0	3	Do Not Use	
0	4	Do Not Use	
0	5	Do Not Use	
0	6	HMI Self-Test	See Note #2.
0	7	Control and Sensor Self-Test	See Note #3.
0	8	Do Not Use	
0	9	Dispenser Recess Heater Test	Turn the dispenser heater ON for 30 seconds.
1	0	Do Not Use	
1	1	Do Not Use	Each fan will run for 5 seconds.
1	2	100% RunTime	See Note #4.
1	3	Do Not Use	
1	4	Toggle the State of Defrost	See Note #5.
1	5	Refrigerator Reset	Causes a system reset except for defrost.
1	6	Test Mode Exit	Exit test mode.
1	7	Do Not Use	
1	8	Do Not Use	

Note #1 (Showroom Mode)

In the showroom mode, the compressor and fans do not operate. The fresh food and freezer lights operate as normal (ON when door is opened). The dispenser and dispenser display operate as normal. Temperature set points can be changed. Press the **DISPLAY TEMP** pad to display the actual cabinet temperature. To exit the showroom mode, cycle power OFF or enter test mode **1 5** to reset the unit.

Note: The showroom mode can also be entered outside of the service mode by simultaneously pressing the **COLDER** pad on the **FREEZER** display and the **WARMER** pad on the **REFRIGERATOR** display for 3 seconds (the display must be lit before pressing the pads).

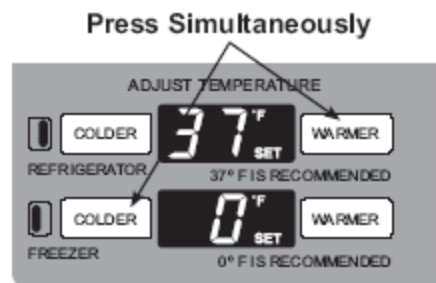

Note #2 (HMI Self-Test)

Once the HMI self-test is started, all of the LEDs and seven segment LEDs will illuminate. The **COLDER** pad turns off the seven segment LEDs and the **WARMER** pad turns off the **SET** LED for both the **FREEZER** and **REFRIGERATOR** displays.

When all the available LEDs have been turned off for that specific temperature board, the **COLDER** and **WARMER** pads on the **REFRIGERATOR** display must be held simultaneously for 3 seconds to exit the HMI self-test. This can be done any time during the test.

Note #3 (Control and Sensor System Self-Test)

This test does a check on all thermistors, fans, and defrost circuits. The thermistor test will display pass, open or shorted. The fan and defrost tests will display pass or fail. Once this test is invoked, the test mode will stop flashing and the numbers from 1 to 10 (corresponding to the chart below) will appear on the HMI display.

1	FZ Room Sensor	6	FZ Fan Error
2	FZ Defrost Sensor	7	FF Fan Error
3	FF Room Sensor	8	Condenser Fan Error
4	FF Defrost Sensor	9	FZ Defrost Error
5	Ambient Sensor	10	FF Defrost Error

For each test, the HMI will respond by displaying the following:

P = Pass

F = Fail

O = Open Thermistor Circuit

S = Short Thermistor Circuit

The control will display an **O** if the thermistor value is greater than 149.2K Ω ! (-58°F (-50°C)). The control will display a **S** if the thermistor value is less than 1.34K Ω ! (149°F (65°C)).

Note #4 (100% Run Time)

This test runs the sealed system 100% of the time and will automatically time out after 1 hour. Cycle power OFF or enter test mode **1 5** to reset and exit this mode.

Note: The 3-way valve position during 100% run time depends on the fresh food temperature. If the fresh food temperature is satisfied, the 3-way valve opens to the freezer evaporator only. If it is not satisfied, the valve opens to the fresh food evaporator and refrigerant flows through both evaporators.

Note #5 (Toggle the State of Defrost)

Any time a pad on the temperature board (other than the **COLDER** and **WARMER** pads) is pressed, the status of the defrost heaters will toggle in the following sequence:

1. Fresh food heater ON.
2. Fresh food and freezer heaters ON.
3. Fresh food and freezer heaters OFF.

Pressing the pad a fourth time will cycle through the sequence again. During the sequence, heater current can be measured.

- Fresh food heater - approximately 1.2 amps when measured at the CN01 connector black wire.
- Fresh food and freezer heaters - approximately 4 amps when measured at the CN01 connector black wire.

Troubleshooting Notes

Problem	Action
Refrigerator HMI displays a temperature of 80°F (27°C), even though the temperature in the refrigerator section is correct.	The HMI may display 80°F (27°C) if the refrigerator thermistor (air) is either open or shorted. Run service diagnostics (Test 0 7) to confirm.
Freezer HMI displays -25°F (-32°C), even though the temperature in the freezer section is correct.	The HMI may display -25°F (-32°C) if the freezer thermistor (air) is open. Run service diagnostics (Test 0 7) to confirm.
Freezer HMI displays 80°F (27°C), even though the temperature in the freezer section is correct.	The HMI may display 80°F (27°C) if the freezer thermistor (air) is shorted. Run service diagnostics (Test 0 7) to confirm.
Unit is dead (except for interior lights). CN1 connector reads 120VAC.	Check the compressor overload. Control board will not receive voltage if the overload is open.
Ambient air thermistor fails service diagnostics test. HMI displays open circuit.	Check the thermistor connection behind the HMI display to see if the pins are pushed out of the connector.

Schematics

AC Section

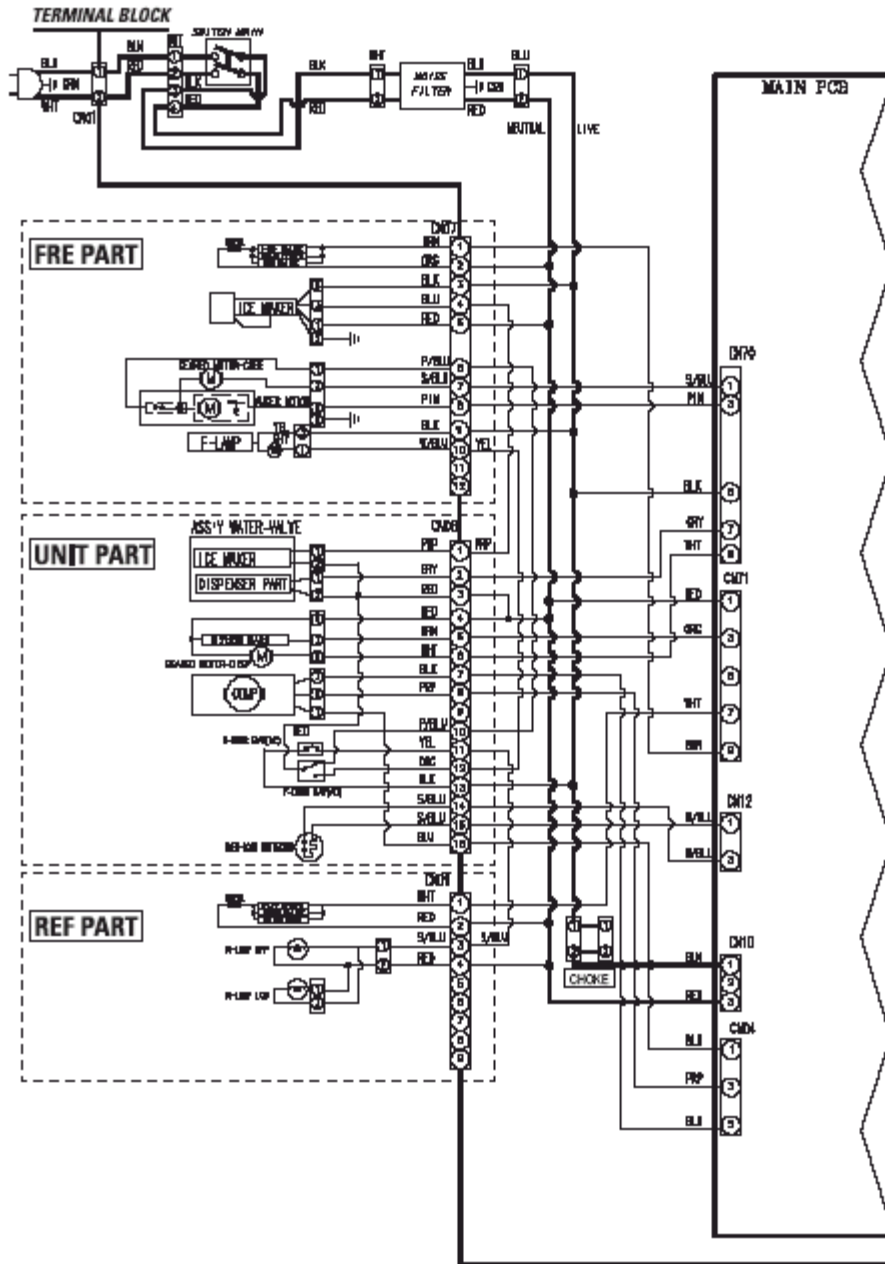

(Part 1)

Schematics (Part 2)

DC Section

