



ELECTROLUX HOME PRODUCTS NORTH AMERICA

SERVICE MANUAL

3.0 Cu. Ft. HORIZONTAL

AXIS WASHER

GOOD & BETTER MODELS

Frigidaire

TAPPAN

W White-Westinghouse

Gibson

Kelvinator 

5995413084

December 2004

SAFE SERVICING PRACTICES - ALL APPLIANCES

To avoid personal injury and/or property damage, it is important that **Safe Servicing Practices** be observed. The following are some limited examples of safe practices:

1. **DO NOT** attempt a product repair if you have any doubts as to your ability to complete it in a safe and satisfactory manner.
2. Before servicing or moving an appliance:
 - Remove the power cord from the electrical outlet, trip the circuit breaker to the OFF position, or remove the fuse.
 - Turn off the gas supply.
 - Turn off the water supply.
3. Never interfere with the proper operation of any safety device.
4. **USE ONLY REPLACEMENT PARTS CATALOGED FOR THIS APPLIANCE. SUBSTITUTIONS MAY DEFEAT COMPLIANCE WITH SAFETY STANDARDS SET FOR HOME APPLIANCES.**
5. **GROUNDING:** The standard color coding for safety ground wires is **GREEN**, or **GREEN** with **YELLOW STRIPES**. Ground leads are not to be used as current carrying conductors. It is **EXTREMELY** important that the service technician reestablish all safety grounds prior to completion of service. Failure to do so will create a hazard.
6. Prior to returning the product to service, ensure that:
 - All electrical connections are correct and secure
 - All electrical leads are properly dressed and secured away from sharp edges, high-temperature components, and moving parts
 - All non-insulated electrical terminals, connectors, heaters, etc. are adequately spaced away from all metal parts and panels
 - All safety grounds (both internal and external) are correctly and securely connected
 - All panels are properly and securely reassembled

ATTENTION!!!

This service manual is intended for use by persons having electrical and mechanical training and a level of knowledge of these subjects generally considered acceptable in the appliance repair trade. Electrolux Home Products cannot be responsible, nor assume any liability, for injury or damage of any kind arising from the use of this manual.

SAFE SERVICING PRACTICES	2
Model lines	7
QUICK REFERENCE SHEET	8
Serial nameplate location	8
Serial number breakdown	8
Tech sheet location	8
Component resistance chart	9
Water fill height	9
Electrical requirements	9
Incoming water pressure	9
Drain requirements	9
Motor	9
On line test	10
Operation speeds	11
Tub pulley to motor pulley ratio	12
Tub capacity	12
Auto temp control temperature specifications	12
Sample schematic (Good Models)	13
Sample schematic (Better Models)	14
Operation chart	15
SECTION A - INSTALLATION INSTRUCTIONS	16
What to do if you smell gas	16
Pre-installation requirements	16
Tools required for installation	16
Electrical requirements	16
Circuit	16
Power supply	16
Outlet receptacle	16
Grounding requirements	16
Water supply requirements	17
Drain requirements	17
Rough-in dimensions	18
Location of your washer	20
Do not install your washer	20
Minimum installation clearances	20
Unpacking	20
Drain hose installation	21
Installation	22
Replacement parts	23
SECTION B - Washer & Dryer Pedestal Installation Instructions	24
Washer Installation	24
Dryer installation	26
Warranty	28
SECTION C - OPERATING INSTRUCTIONS	29
Before operating your washer	29
Operating steps	29
Cycle selection	30
Heavy duty	30
Normal wash	30
Perm press	30
Quick	30
Sport	30
Delicates	30
Handwash	30
Soak	30
Drain/spin	30

Rinse/spin _____	30
Cycle settings _____	31
Wash/rinse water temperature _____	31
Final spin speed _____	31
Water level _____	31
Cycle options _____	31
Heavy soil/stain _____	31
Extra rinse _____	31
Extra spin _____	31
Cycle signal _____	31
Washer features _____	31
Delay start _____	31
Control lock _____	31
Status lights _____	31
Washer settings chart _____	32
Error code chart _____	33
SECTION D - OWNER'S GUIDE _____	34
Product record _____	34
Your safety and the safety of others is very important _____	34
Pedestal _____	34
Important safety instructions _____	34
Read all instructions before using this washer _____	34
Prevent fire _____	34
Protect Children _____	34
Prevent Injury _____	35
Washing procedures _____	36
Sort laundry into loads that can be washed together _____	36
Prepare items for washing _____	37
Pretreat stains and heavy soil _____	37
Add laundry load to washer _____	37
Add detergent, bleach and fabric softener to automatic dispenser _____	37
Start the washer _____	39
Remove items when the cycle is completed _____	39
General precautions _____	39
Stain removal _____	39
Safe stain removal procedures _____	40
Stain removal _____	41
Common washing problems _____	42
Care and cleaning _____	43
Outside _____	43
Cleaning the dispenser drawer area _____	43
Winterizing instructions _____	44
Avoid service checklist _____	45
Warranties _____	48
SECTION E - OPERATION _____	50
Control _____	50
Dispenser Drawer Reed Switch _____	50
Door Switch Assembly _____	50
Pressure Switch _____	51
Electronic water level sensor _____	52
Water Inlet Valve _____	52
Auto Temp System (Better Models) _____	54
Automatic Dispenser _____	54
Drain Pump _____	58
Speed Control _____	59
Motor _____	59

SECTION F - CONSTRUCTION	60
Cabinet	60
Front Panel and Door Assembly	60
Bellows (Door Boot)	60
Outer Tub Assembly	60
Spin Basket Assembly	60
SECTION G - TROUBLESHOOTING	61
Failure code chart	62
Test	63
Jacks and plugs	65
SECTION H - TEARDOWN	66
Removing the detergent drawer	66
Detergent drawer disassembly	66
Removing door strike	67
Removing the door handle	67
Removing loading door	67
Disassembling the door	68
Removing loading hinges	68
Releasing the bellows from the front panel	69
Removing the door safety switch	69
Removing the front service panel	70
Removing the drain pump assembly	70
Disassembling the drain pump	71
Removing the top panel	71
Removing the pressure switch	72
Removing the electronic water level sensor	72
Releasing the console	72
Removing the reed switch	73
Removing the water temperature selector knob (Good Models)	73
Removing the console	74
Removing the electronic control	74
Removing the selector knob (Good Models)	74
Removing the water temperature selector shaft (Good Models)	74
Removing the selector dial (Better Models)	75
Removing the selector knob (Better Models)	75
Removing the programing buttons and springs	75
Removing the front panel	75
Removing the console mounting brace	76
Removing the bellow or boot	76
Reinstalling or replacing the boot	77
Removing the weight ring	79
The water inlet and overflow/vent tube grommet	79
Removing the water inlet grommet	79
Removing the overflow/vent tube grommet	80
Removing the overflow/vent tube	80
Removing the water inlet valve assembly	81
Removing the water inlet screens	82
Removing the top rear brace	82
Removing the suspension springs	82
Removing the top center brace	83
Removing the detergent cavity assembly	83
Removing the detergent dispenser outlet hose	85
Removing the siphon break hose	85
Removing the drain sump	85
Removing the hose between the drain pump and the drain hose coupler	85
Removing the external drain hose	86

Removing the drain hose coupler _____	86
Removing the rear access panel _____	86
Drive belt _____	87
To remove or replace the drive belt _____	87
Removing the large pulley _____	87
Removing the drive motor _____	88
Removing the speed control board assembly _____	88
Removing the right hand air shock absorber _____	90
Removing the left hand air shock absorber _____	90
To remove the air bell _____	91
Removing the tub assembly _____	91
Removing the spin basket and rear tub half _____	94
Removing the spin basket vanes _____	94

Model Lines

This manual will cover the Good and Better model lines of the 3.0 Cu. Ft. HORIZONTAL AXIS WASHER.

Differences:

Good Models

1. Control panel does not have a display.



2. Water fill height control is a pressure switch.



3. Does not have a water temperature sensor.

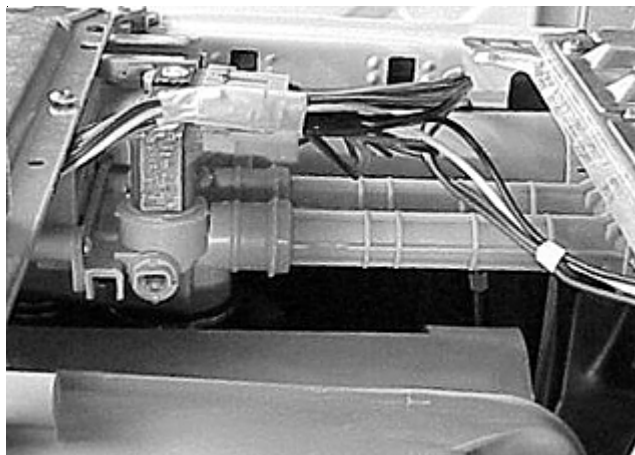

Better Models

1. Control panel has a display.



2. Water fill height control is a electronic pressure sensor.

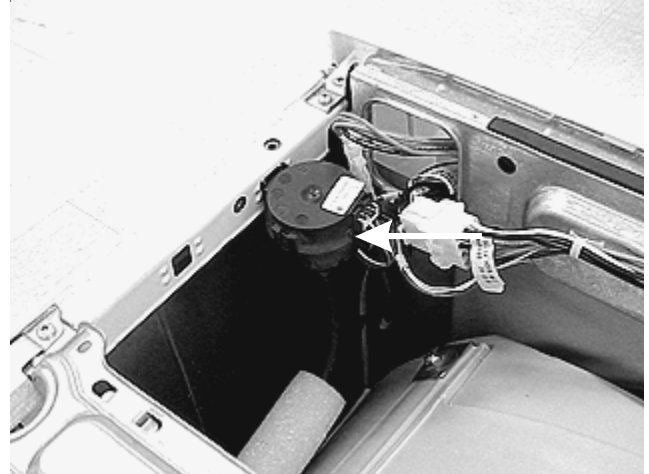

3. Has a water temperature sensor.

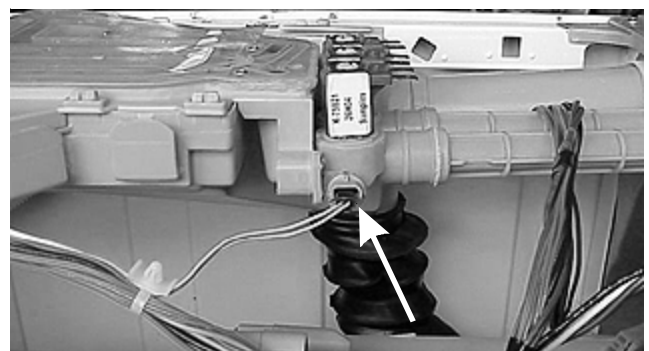

QUICK REFERENCE SHEET

1. Serial nameplate location:

On the front panel at the lower left of the washer door opening.

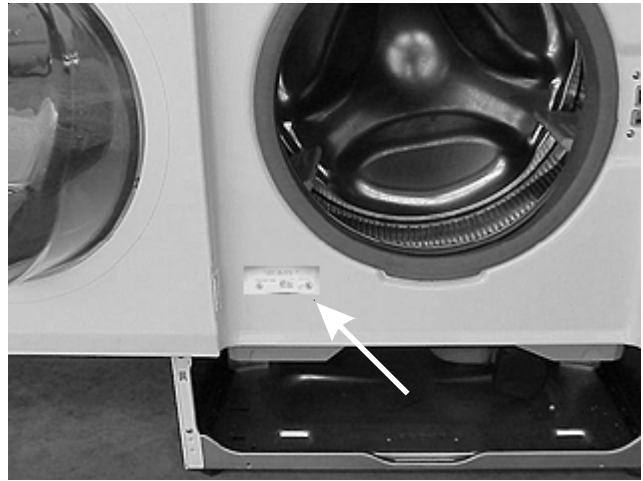

2. Serial number breakdown.

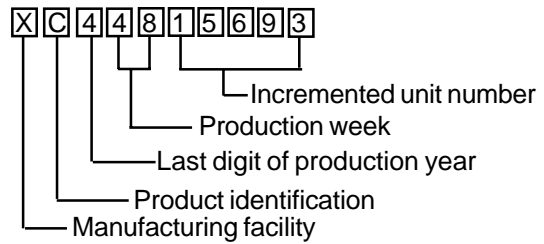

3. Tech sheet location

On the lefthand bodyside behind the front access panel.



QUICK REFERENCE SHEET

Component resistance chart.

Electrical component		Resistance Ω @ 77° F (25°C)
Dispenser valve solenoids		800 \pm 7%
Door lock solenoid		1325 \pm 10%
Pump motor		12 \pm 7%
NTC Thermistor		50K \pm 2%
Motor	M1 TO M2	5.3 \pm 7%
	M2 TO M3	5.3 \pm 7%
	M1 TO M3	5.3 \pm 7%
	M4 TO M5	118 \pm 7%

Good Models

Water fill height 4 \pm .5 "

No load, start position of permanent press cycle.

Better Models

Water fill height dependent upon selected cycle.

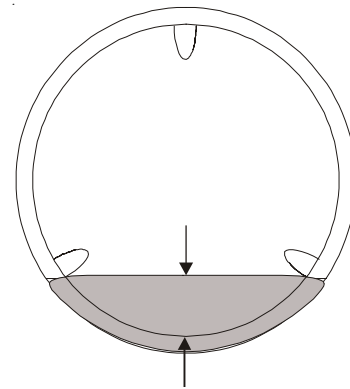

Electrical requirements.

Circuit - Individual, properly polarized and grounded 15 amp. branch circuit fused with 15 amp. time delay fuse or circuit breaker.

Incoming water pressure.

30 and 120 pounds per square inch (maximum unbalance pressure, hot vs. cold, 10 psi.)

Drain requirements.

Drain capable of eliminating 17 gals (64.3 L) per minute.

A standpipe diameter of 1-1/4 in. (3.18 cm) minimum.

The standpipe height above the floor should be:

Minimum height: 24 in. (61 cm)

Maximum height: 96 in. (244 cm)

Motor.

No load agitate wattage - Max 150

No load spin wattage - Max 550

Diagnostic Test:

The diagnostic test is performed by using the Program Knob. To START THE TEST:

- On non-digital display models, turn the **Program Knob** to start position, **Drain/Spin**.
 - On digital display models, turn the **Program Knob** to start position, **Touch Up**.
 - Press **Pause/Cancel** to turn off LEDs.
 - Within 5 seconds, press and hold the **Option** and **Pause Cancel** buttons until LEDs start sequentially chasing, then release buttons.
1. All the LEDs will sequentially light. Pressing a button below a light cluster will light all the LEDs in that cluster at one time to confirm functionality.
 2. Turn the program knob (1) click clockwise from the start position. The hot water solenoid will activate and hot water should enter through the detergent compartment.
 3. Turn the program knob (2) clicks from the start position. The bleach water solenoid will activate and cold water should enter through the bleach compartment.
 4. Turn the program knob (3) clicks from the start position. The bleach and the wash water solenoids will activate and cold water should enter through the softener compartment.
 5. Turn the program knob (4) clicks from the start position. The door lock solenoid will activate.
 6. Turn the program knob (5) clicks from the start position. The door lock solenoid will deactivate and the loading door can be opened.
 7. Turn the program knob (6) clicks from the start position. The washer will fill and tumble.
 8. Turn the program knob (7) clicks from the start position. The washer will fill and spin (leakage test).
 9. Turn the program knob (8) clicks from the start position. The drain pump and door lock solenoid will activate and the washer will operate in high spin.
SAFETY WARNING: If power is removed during this test, the door can be opened. To prevent injury, DO NOT put your hands inside when the tub is rotating.

10. Turn the program knob (9) clicks from the start position. The control will signal the last error code. **See Section F, Troubleshooting**, for details for properly identifying the error code on non-digital display models.

Exiting Diagnostic Mode

There are two options for exiting the Diagnostic Test mode and returning the washer to normal operation:

- a) Unplug the power cord, wait 5-8 seconds, then reconnect the power cord **OR**
- b) Turn the program knob clockwise 2 or 3 clicks after the Start Position. Press **Options** and **Pause Cancel** buttons together for a few seconds until wash cycle LEDs appear.

If a situation arises where you cannot exit the Diagnostic mode as described above and the bank of 5 LED's on the right end remain ON regardless of Program Knob position, a combination of pushed buttons caused the control to enter a special factory test mode. Disconnect power to reset the control to return washer to normal operation is this occurs.

To clear latest stored error code:

Place the control into Diagnostic test Mode.

- Turn the program knob clockwise 9 clicks from the Start Position. The control will signal the last error code.
- Press and hold the **Options** and **Pause Cancel** buttons for 3 seconds. The code will be cleared.
- Exit Diagnostic Mode to return the washer to normal operation.

Operation speeds:

Agitate Speed - RPM (Heavy, Normal, Quick, Prem Press, Soak and Towels)	47	
Agitate Speed - RPM (Hand Wash, Sport, Delicate, and Wool)	32	
Spin speeds	Good Models	Better Models
Heavy Duty, Normal & Quick		
Spin Speed R.P.M. (Hang Dry)	NA	NA
Spin Speed R.P.M. (Low)	850	950
Spin Speed R.P.M. (Medium)	900	1000
Spin Speed R.P.M. (Max)	950	1050
Perm Press & Sport		
Spin Speed R.P.M. (Hang Dry)	450	450
Spin Speed R.P.M. (Low)	800	800
Spin Speed R.P.M. (Medium)	850	850
Spin Speed R.P.M. (Max)	900	900
Delicate & Hand Wash		
Spin Speed R.P.M. (Hang Dry)	350	350
Spin Speed R.P.M. (Low)	350	350
Spin Speed R.P.M. (Medium)	400	400
Spin Speed R.P.M. (Max)	450	450
Soak		
Spin Speed R.P.M. (Hang Dry)	NA	NA
Spin Speed R.P.M. (Low)	350	350
Spin Speed R.P.M. (Medium)	400	400
Spin Speed R.P.M. (Max)	450	450
Rinse/Spin & Drain/Spin		
Spin Speed R.P.M. (Hang Dry)	450	450
Spin Speed R.P.M. (Low)	850	950
Spin Speed R.P.M. (Medium)	900	1000
Spin Speed R.P.M. (Max)	950	1050
Wool		
Spin Speed R.P.M. (Hang Dry)	NA	NA
Spin Speed R.P.M. (Low)	NA	350
Spin Speed R.P.M. (Medium)	NA	400
Spin Speed R.P.M. (Max)	NA	450
Bulky		
Spin Speed R.P.M. (Hang Dry)	NA	NA
Spin Speed R.P.M. (Low)	NA	800
Spin Speed R.P.M. (Medium)	NA	850
Spin Speed R.P.M. (Max)	NA	900

Operation speeds:

Good Models

Better Models

Touch Up		
Spin Speed R.P.M.(Hang Dry)	NA	450
Spin Speed R.P.M. (Low)	NA	950
Spin Speed R.P.M. (Medium)	NA	1000
Spin Speed R.P.M. (Max)	NA	1050
Tub Pulley to Motor Pulley Ratio _____ 16 TO 1		
Tub Capacity _____ 3.0 cu. ft.		
Automatic Temperature Control Specifications. (Better Models)		
Regulated hot/coldsetings_____		130° ± 7° F
Regulated warm/warm and warm /cold settings_____		90° ± 7° F
Regulated cold/cold settings _____		65° ± 7° F

SAMPLE SCHEMATIC FOR GOOD MODELS

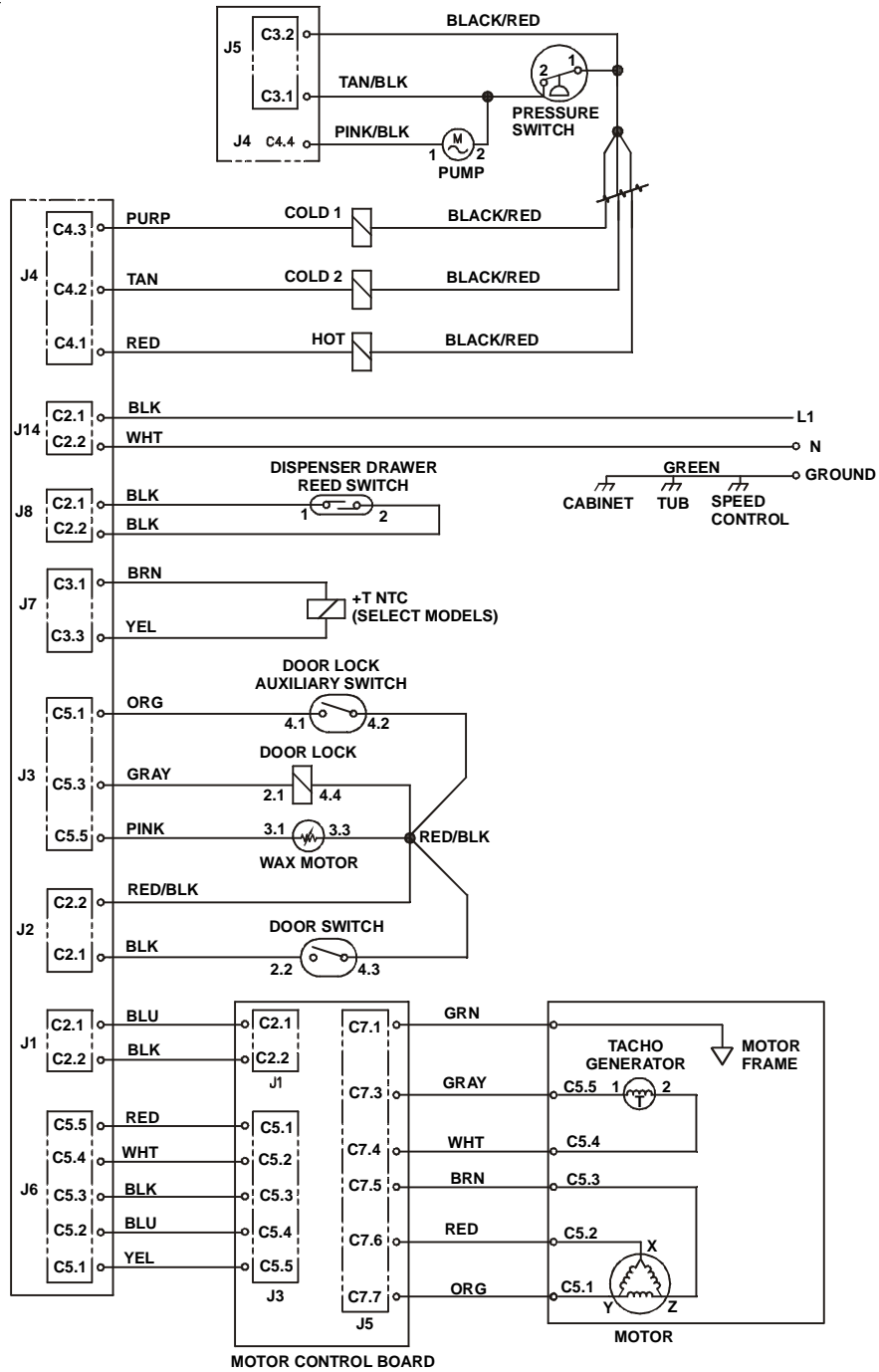

DISPENSER VALVE

EVENT	COLD 1	COLD 2
DETERGENT	O	X
BLEACH	X	O
SOFTNER	X	X

X = CLOSED O = OPEN

WIRING CODES
⊕ CONNECTION
⊖ NO CONNECTION
⏏ CABINET GROUND
⏏ LOCAL GROUND

SAMPLE SCHEMATIC FOR BETTER MODELS

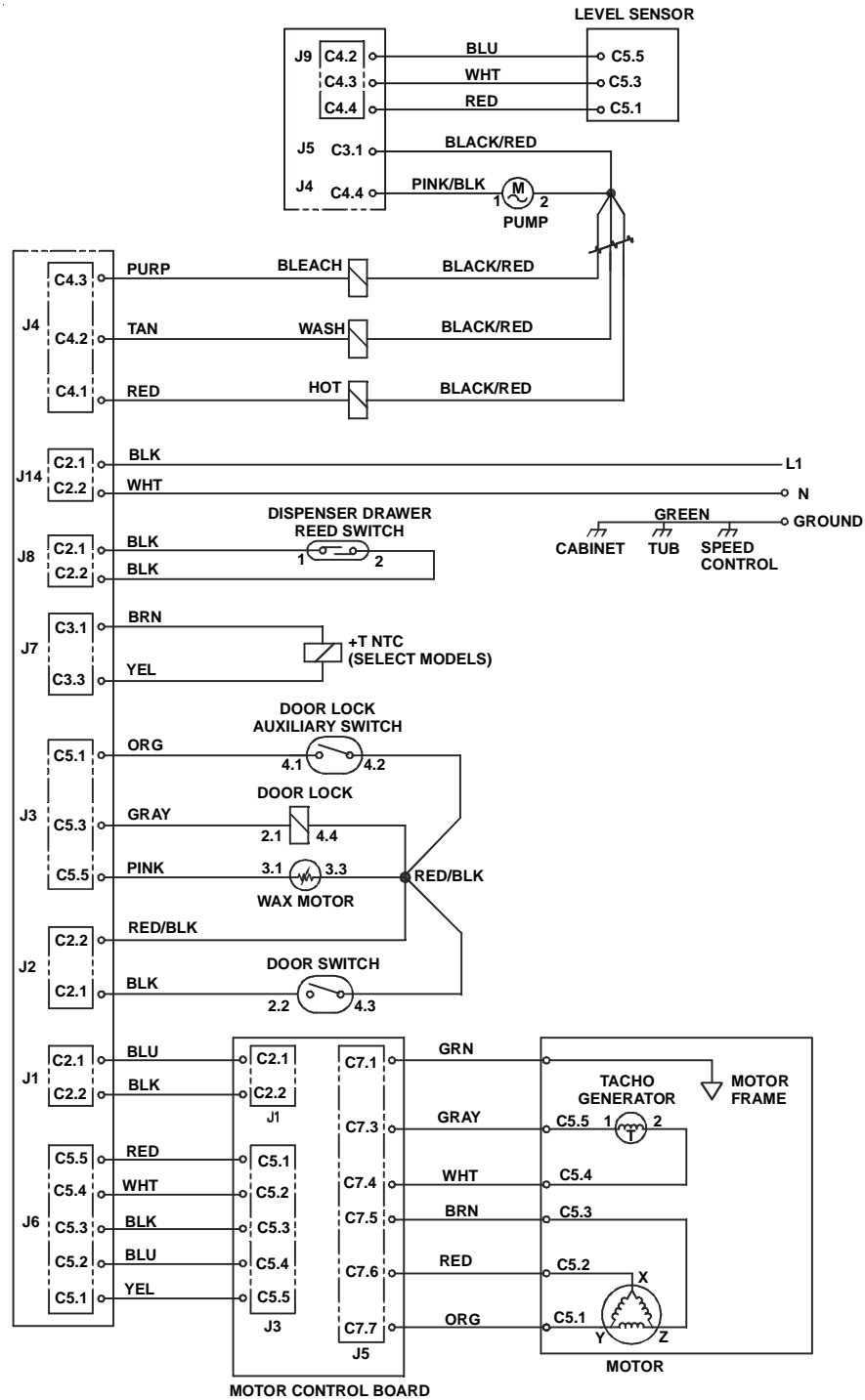

DISPENSER VALVE

EVENT	COLD 1	COLD 2
DETERGENT	O	X
BLEACH	X	O
SOFTNER	X	X

X = CLOSED O = OPEN

WIRING CODES	
+	CONNECTION
+	NO CONNECTION
///	CABINET GROUND
▽	LOCAL GROUND

OPERATION CHART

Wash Cycle	Wash Phase	*Estimated Step Time (sec)	Pump	Dispenser
Heavy (Heavy opt.) (Normal)	Fill and Tumble	60	OFF	Wash (Det)
	Fill Then Tumble	300	OFF	Wash (Det)
	Fill Then Tumble	120	OFF	Wash (Det)
	Fill Then Tumble	660	OFF	Wash (Det)
	Tumble	120	OFF	OFF
	Drain/spin	180	ON	OFF
Rinse/Spin	Fill and Tumble	90	OFF	BLEACH
	Fill Then Tumble	180	OFF	BLEACH
	Drain/spin	180	ON	OFF
	Fill and Tumble	90	OFF	BLEACH
	Fill Then Tumble	180	OFF	BLEACH
	Drain/spin	180	ON	OFF
Extra Rinse	Fill and Tumble	90	OFF	BLEACH
	Fill Then Tumble	240	OFF	BLEACH
	Drain/spin	180	ON	OFF
	Fill and Tumble	90	OFF	FABRIC
	Fill Then Tumble	120	OFF	FABRIC
	Drain	30	ON	OFF
	Spin	570	ON	OFF
Extra spin	Spin	180	ON	OFF
	Tumble	150	OFF	OFF
*Estimated Cycle Time (min)		Stop	53	OFF OFF

Wash Cycle	Wash Phase	*Estimated Step Time (sec)	Pump	Dispenser
Normal (Normal) (Light)	Fill and Tumble	60	OFF	Wash (Det)
	Fill Then Tumble	300	OFF	Wash (Det)
	Fill Then Tumble	180	OFF	Wash (Det)
	Fill Then Tumble	300	OFF	Wash (Det)
	Tumble	120	OFF	OFF
	Drain/spin	60	ON	OFF
Rinse/Spin	Fill and Tumble	90	OFF	BLEACH
	Fill Then Tumble	180	OFF	OFF
	Drain/spin	180	ON	OFF
	Fill and Tumble	90	OFF	BLEACH
	Fill Then Tumble	180	OFF	OFF
	Drain/spin	180	ON	OFF
Extra Rinse	Fill Then Tumble	90	OFF	BLEACH
	Fill Then Tumble	180	OFF	BLEACH
	Drain/spin	180	ON	OFF
	Fill and Tumble	90	OFF	FABRIC
	Fill Then Tumble	180	OFF	FABRIC
	Drain	30	ON	OFF
	Spin	570	ON	OFF
Extra spin	Spin	180	ON	OFF
	Tumble	150	OFF	OFF
*Estimated Cycle Time (min)		Stop	49	OFF OFF

SECTION A - Installation Instructions

Full Size Tumble Action Washers

Before beginning installation, carefully read these instructions. This will simplify the installation and ensure the washer is installed correctly and safely. Leave these instructions near the washer after installation for future reference.

NOTE: The electrical service to the washer must conform with local codes and ordinances and the latest edition of the National Electrical Code, ANSI/NFPA 70.

⚠ WARNING For your safety the information in

this manual must be followed to minimize the risk of fire or explosion or to prevent property damage, personal injury or loss of life.

- Do not store or use gasoline or other flammable vapors and liquid in the vicinity of this or any other appliance.

WHAT TO DO IF YOU SMELL GAS

- Do not try to light any appliance.
- Do not touch any electrical switch; do not use any phone in your building.
- Clear the room, building or area of all occupants.
- Immediately call your gas supplier from a neighbor's phone. Follow the gas suppliers instructions.
- If you cannot reach your gas supplier, call the fire department.

Installation and service must be performed by a qualified installer, service agency or the gas supplier.

PRE-INSTALLATION REQUIREMENTS

Tools Required for Installation:

1. Phillips screwdriver
2. 10 mm socket with ratchet.
3. Channel-lock adjustable pliers.
4. Carpenter's level.

ELECTRICAL REQUIREMENTS

CIRCUIT - Individual, properly polarized and grounded 15 amp. branch circuit fused with 15 amp. time delay fuse or circuit breaker.

POWER SUPPLY - 2 wire, with ground, 120 volt, single phase, 60 Hz, Alternating Current. NOTE: The use of this washer with power created by gas powered generators, solar powered generators, wind powered generators or any other generator other than the local utility company is not recommended.

OUTLET RECEPTACLE - Properly grounded 3-prong receptacle to be located so the power supply cord is accessible when the washer is in an installed position.

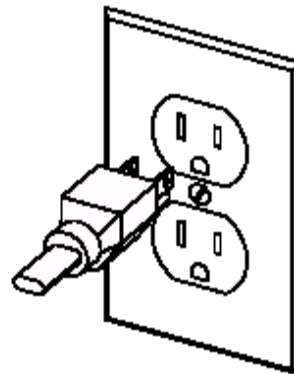

NOTE: GFI (Ground Fault Interrupter) receptacle is not required.

GROUNDING REQUIREMENTS

⚠ WARNING Improper connection of the equipment grounding conductor can result in a risk of electrical shock. Check with a licensed electrician if you are in doubt as to whether the appliance is properly grounded.

1. The washer **MUST** be grounded. In the event of malfunction or breakdown, grounding will reduce the risk of electrical shock by a path of least resistance for electrical current.

- Since your washer is equipped with a power supply cord having an equipment-grounding conductor and a grounding plug, the plug **MUST** be plugged into an appropriate, copper wired receptacle that is properly installed and grounded in accordance with all local codes and ordinances or in the absence of local codes, with the National Electrical Codes, ANSI/NFPA 70 (latest edition). If in doubt, call a licensed electrician. **DO NOT** cut off or alter the grounding prong on the power supply cord. In situations where a two-slot receptacle is present, it is the owner's responsibility to have a licensed electrician replace it with a **properly grounded** three prong grounding type receptacle.

WATER SUPPLY REQUIREMENTS

Hot and cold water faucets **MUST** be installed within 42 inches (107 cm) of your washer's water inlet. The faucets **MUST** be 3/4 inch (1.9 cm) garden hose type so inlet hoses can be connected. Water pressure **MUST** be between 30 and 120 pounds per square inch (maximum unbalance pressure, hot vs. cold, 10 psi.) Your water department can advise you of your water pressure. The hot water temperature should be about 140 degrees F (60 degrees C).

DRAIN REQUIREMENTS

- Drain capable of eliminating 17 gals (64.3 L) per minute.
- A standpipe diameter of 1-1/4 in. (3.18 cm) minimum.
- The standpipe height above the floor should be:

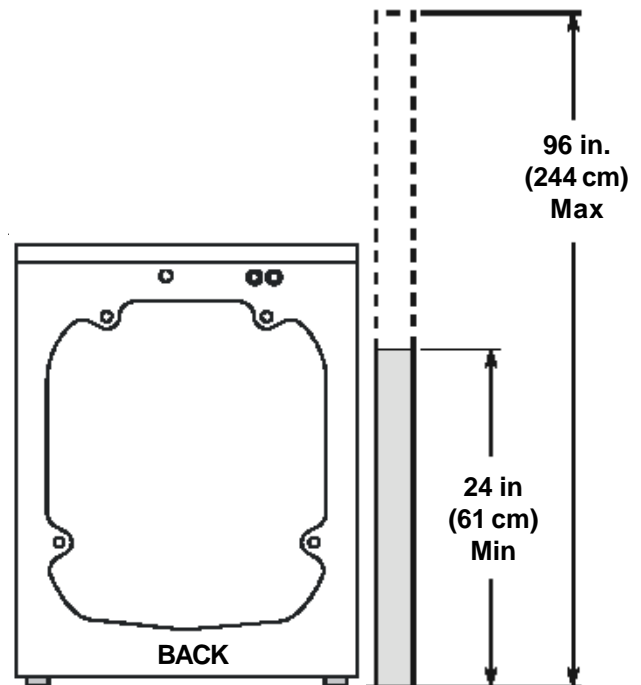

Minimum height: 24 in. (61 cm)

Maximum height: 96 in. (244 cm)

NOTE:

Drain hose attached to the washer can reach a 90 in. (229 cm) high standpipe. For a higher standpipe, use hose P/N 134369410 available from an authorized parts distributor.

ROUGH-IN DIMENSIONS

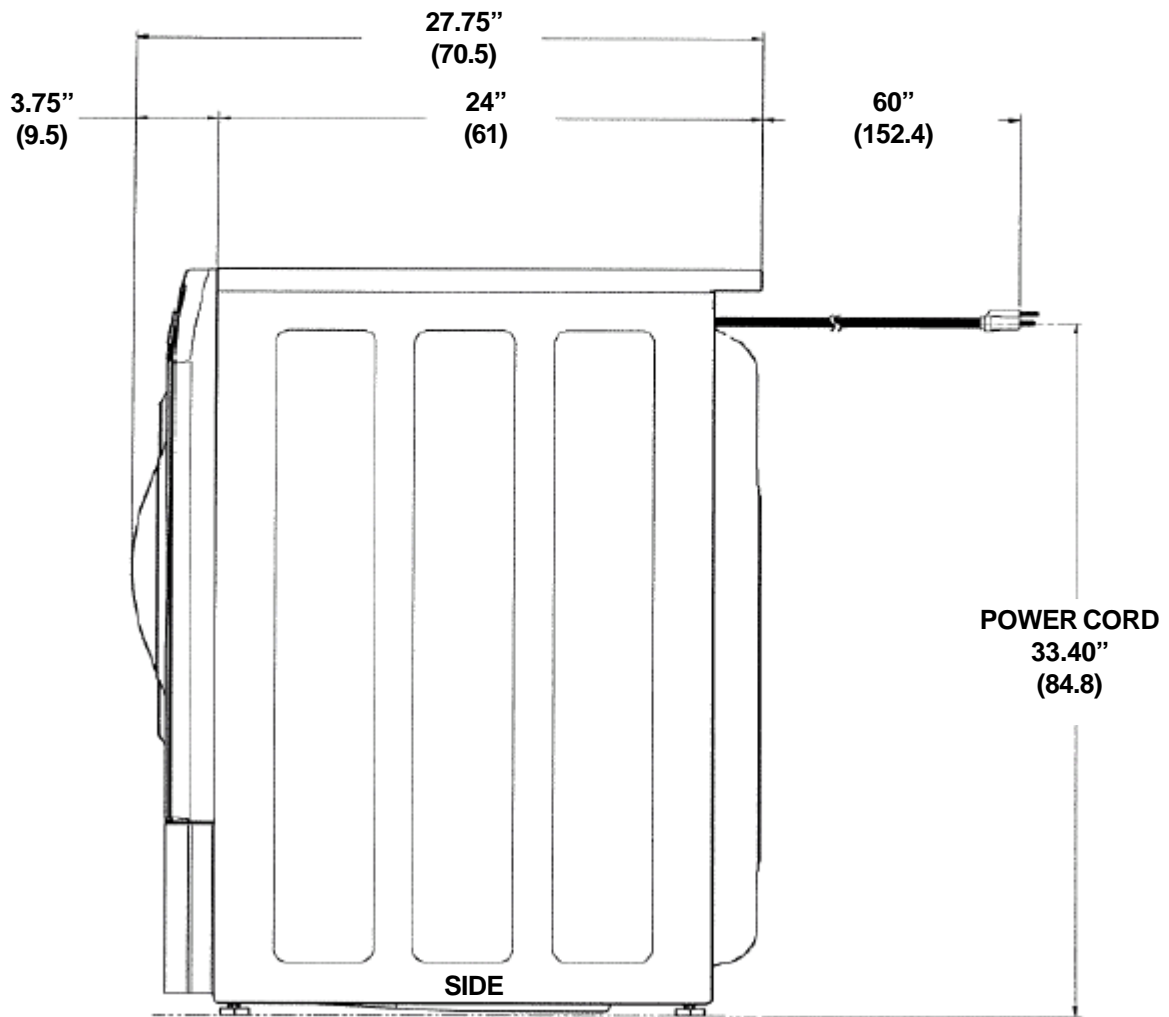

ROUGH-IN DIMENSIONS

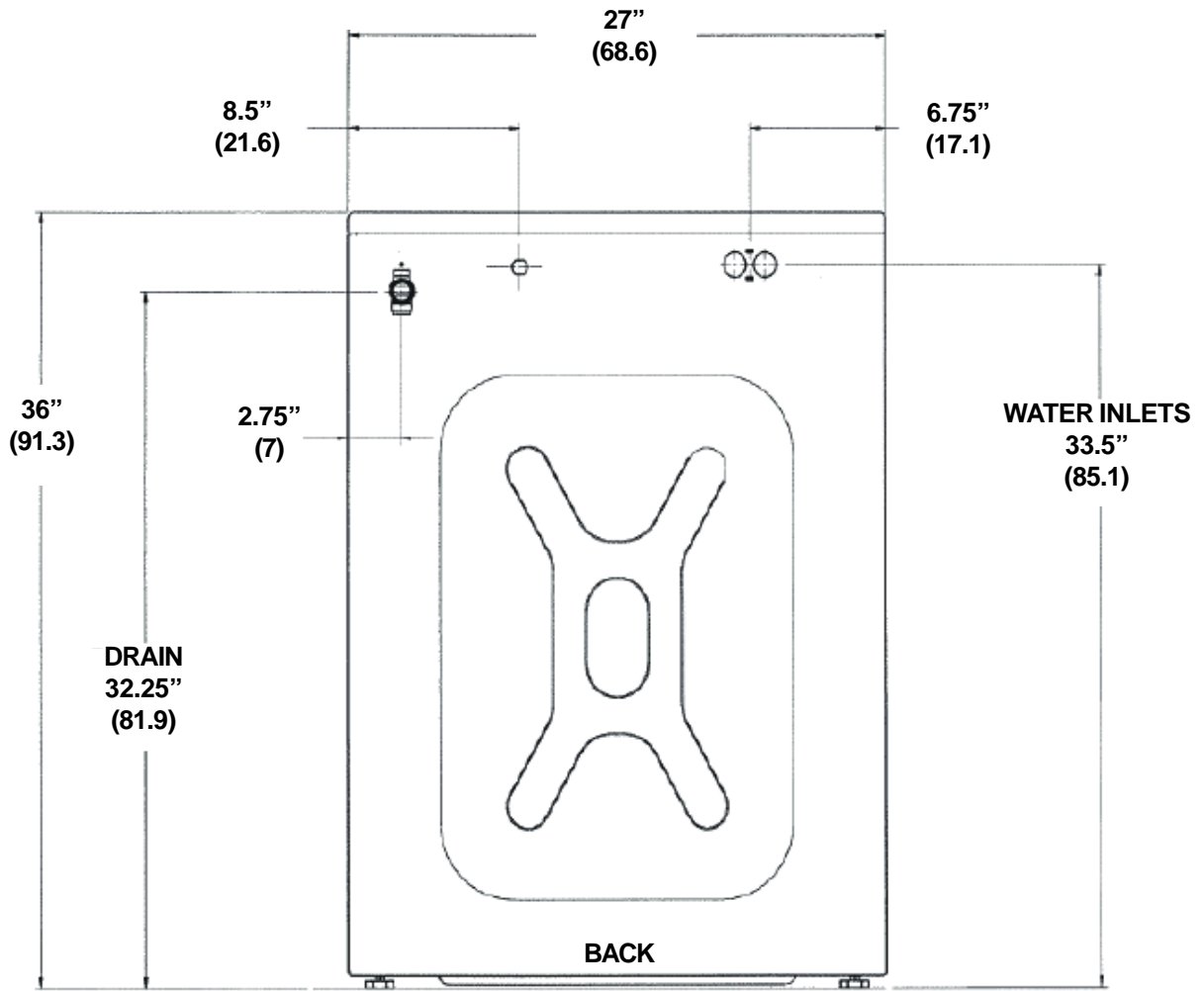

LOCATION OF YOUR WASHER

DO NOT INSTALL YOUR WASHER:

1. In an area exposed to dripping water or outside weather conditions. The ambient temperature should never be below 60 ° F (15.6 ° C) for proper washer (detergent breakdown) operation.
2. In an area where it will come in contact with curtains or drapes.
3. In an area (garage or garage-type building) where gasoline or other flammables are kept or stored (including automobiles).
4. On carpet. Floor **MUST** be solid with a maximum slope of 1/2 in. per foot (1.27 cm per 30.5 cm). To ensure vibration or movement does not occur, reinforcement of the floor may be necessary.

IMPORTANT

MINIMUM INSTALLATION CLEARANCES

When installed in alcove or closet:

Sides, Rear = 0 in. (0 cm)
Top = 0 in. (0 cm)

When installed in closet: Front = 1 in. (2.54 cm)

Closet door ventilation required: 2 louvered openings each 60 in ² (387 cm ²), 3 in. (7.6 cm) from top and bottom of door.

UNPACKING

1. Cut the shipping carton along the dotted line along the base of the unit.
2. While in the carton carefully lay the washer on its back side.
3. Remove the styrofoam base.
4. Carefully return the washer to an upright position and remove the carton.
5. Carefully move the washer to within 4 feet (122cm) of the final location.

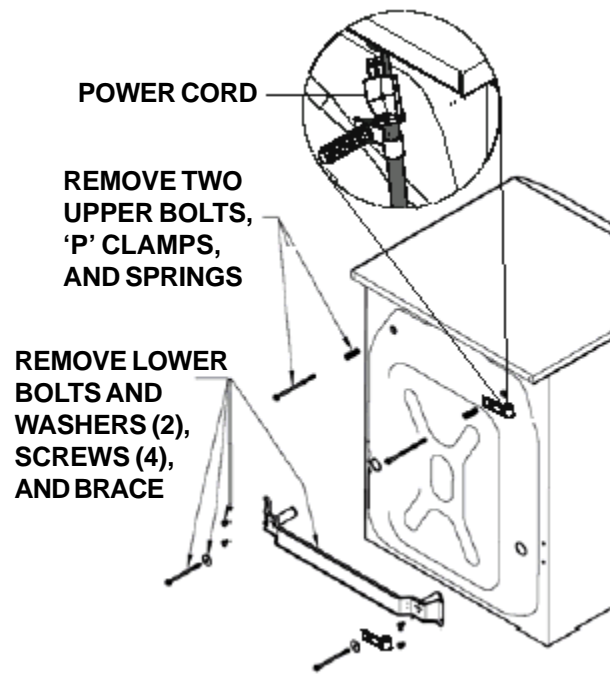

6. Remove the following from the back panel of the washer:

4 packaging bolts,
2 packaging springs,
2 washers,
2 metal "P" clamps,
4 screws,
1 packaging brace.

7. Remove the 4 transport plugs from the literature pack and install them in the corresponding holes in the back panel of the washer.
8. Remove the 4 small hole plugs from the literature pack and install them in the side panel holes vacated by the packaging brace.
9. Using the shipping posts, prop up the front of the washer approximately 2 inches to gain access to the service panel screws.

10. Remove the 2 screws and remove the service panel.

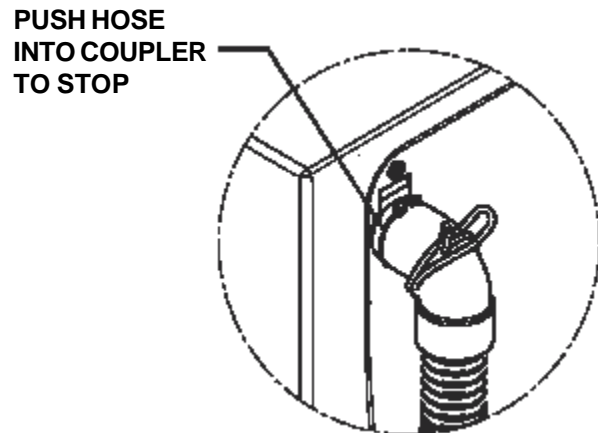
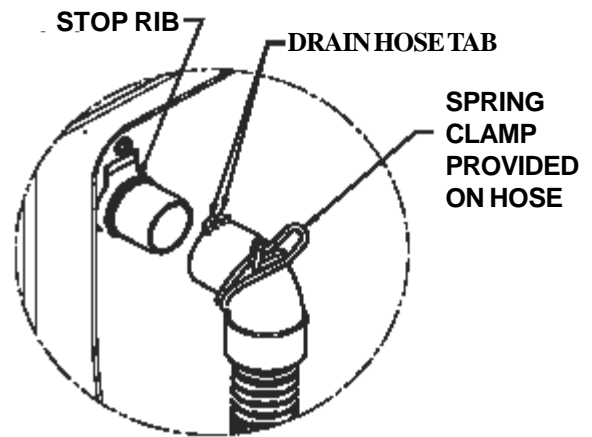
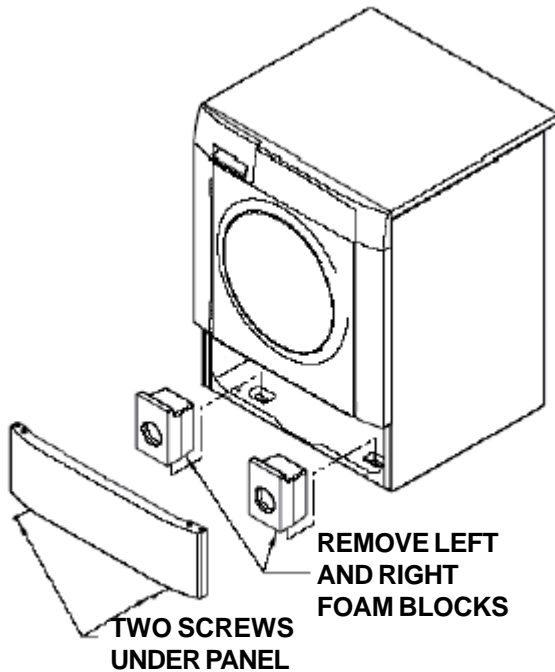

11. Remove the two (2) styrofoam blocks located under the drum (a yellow ribbon surrounds the items to be removed). Lift up on the drum, tilt the base of the foam blocks inwards toward the rear of the washer until free, then pull them out.

12. Remove and discard the yellow ribbon from the front of the washer.

13. Replace the service panel and screws.

NOTE: If the washer is to be transported at a later date, the shipping support hardware must be reinstalled to prevent shipping damage.

3. Using pliers, squeeze the ears of the spring clamp and position the clamp so the clamp ears align with and contact the tabs on the drain hose. This assures proper location of the clamp to prevent leaks.

Drain Hose Installation

The drain hose is field installed to allow hose orientation to the left or right, up or down depending on location of the house drain. The hose is shipped in the washer tub with the spring clamp on the coupler elbow and drain hose hanger installed on the end of the hose.

1. Remove the drain hose from the tub of the washer.

2. Push the hose onto the drain coupler at the upper left of the washer back panel until the hose contacts the STOP RIB.

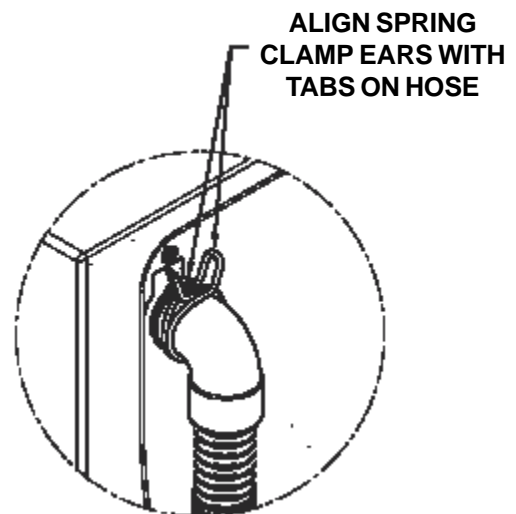

ORIENT HOSE TO RIGHT, LEFT, UP OR DOWN AS NEEDED BEFORE PLACING CLAMP IN POSITION

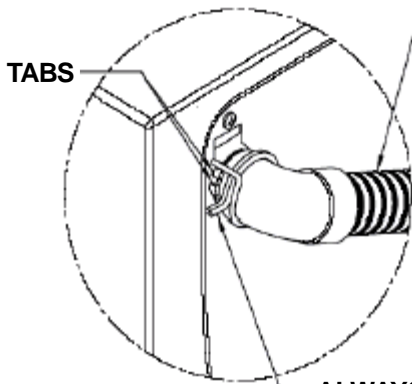

ALWAYS ALIGN CLAMP EARS WITH TABS ON HOSE

INSTALLATION

1. Run some water from the hot and cold faucets to flush the water lines and remove particles that might clog up the water valve screens.

2. Remove the inlet hoses and rubber washers from the plastic bag located in the drum of the washer and install the rubber washers in each end of the inlet hoses.



3. Carefully connect the inlet hose (90° elbow end) marked "HOT" to the outside "H" outlet of the water valve. Tighten by hand, then tighten another 2/3 turn with pliers. Carefully connect the other inlet hose (90° elbow end) to the inside "C" outlet of the water valve. Tighten by hand, then tighten another 2/3 turn with pliers. **Do not crossthread or over-tighten these connections.**

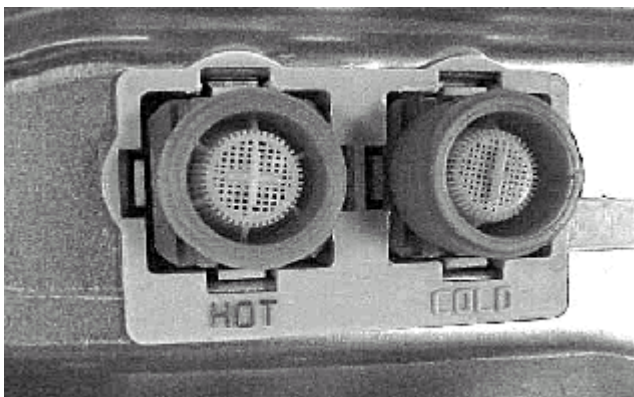

4. Connect the inlet hose ends to the HOT and COLD water faucets tightly by hand, then tighten another 2/3 turn with pliers. Turn the water on and check for leaks.

NOTE: Use only new hoses.

5. Carefully move the washer to its final location. **NOTE:** Do not use the dispenser drawer or door to lift washer.

6. With the washer in its final position, place a level on top of the washer. No rocking of the washer should exist. Adjust the front leveling legs up or down to ensure the washer is resting solid. Rear leg adjustment is accessible through the front service panel.

NOTE: Keep the leg extension at a minimum to prevent excessive vibration. The farther out the legs are extended the more the washer will vibrate.

7. Place the hook end of the drain hose in the drain opening. Secure the drain hose with the cable tie (provided in the enclosure package) to the standpipe, inlet hose, laundry tub, etc. so the hose does not pull out from the force of the water.

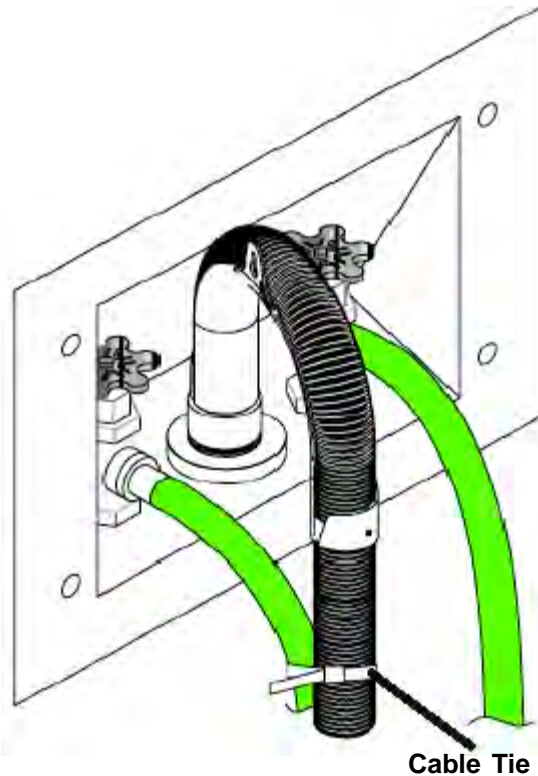

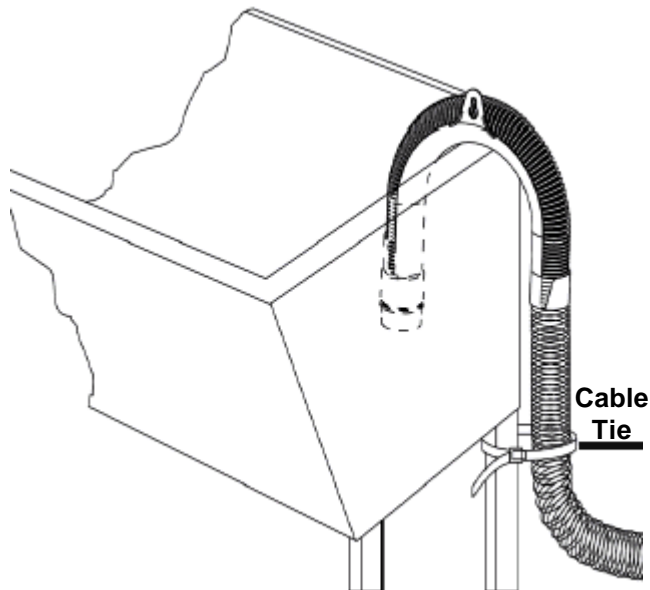
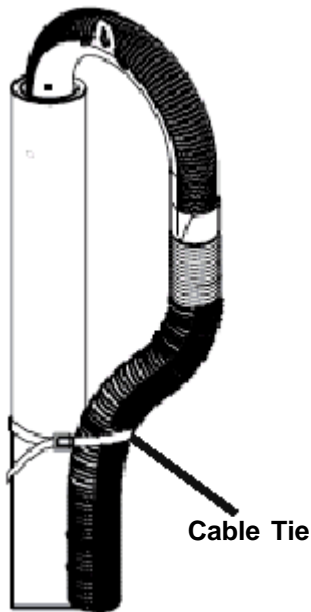

12. If your washer does not operate, please review the “Avoid Service Checklist” in your Owner’s Guide before calling for service.

13. Place these instructions in a location near the washer for future reference.

NOTE: A wiring diagram and technical data sheet are located in an envelope attached to the left hand side panel on the inside of the washer.

REPLACEMENT PARTS

If replacements parts are needed for your washer, contact the source where you purchased your washer, call 1-800-944-9044, or visit our website, www.frigidaire.com, for the Frigidaire Company Authorized Parts Distributor nearest you.

⚠ WARNING Destroy the carton and plastic bags after the washer is unpacked. Children might use them for play. Cartons covered with rugs, bedspreads, or plastic sheets can become airtight chambers causing suffocation. Place all materials in a garbage container or make materials inaccessible to children.

⚠ WARNING The instructions in this manual and all other literature included with this washer are not meant to cover every possible condition and situation that may occur. Good safe practice and caution **MUST** be applied when installing, operating and maintaining any appliance.

Maximum benefits and enjoyment are achieved when all the Safety and Operating instructions are understood and practiced as a routine with your laundering tasks.

8. Plug the power cord into a grounded outlet.

NOTE: Check to ensure the power is off at a circuit breaker/fuse box before plugging the power cord into an outlet.

9. Turn on the power at a circuit breaker/fuse box.

10. Read the Operating Instructions and Owner’s Guide provided with the washer. They contain valuable and helpful information that will save you time and money.

11. Run the washer through a complete cycle. Check for water leaks and proper operation.

SECTION B - Washer & Dryer Pedestal Installation Instructions

IMPORTANT: Read and save these instructions.

NOTICE! This kit is intended to be installed by persons having electrical and mechanical training and a level of knowledge considered acceptable in the appliance repair trade.

Your safety and the safety of others are very important. Many important safety messages are provided in these instructions and on your appliance. Always read and obey all safety messages.



WARNING

EXCESSIVE WEIGHT HAZARD

Two or more people may be required to move and install the washer & dryer onto pedestals. Failure to comply may cause back or other injury.

Tools needed:

- level
- 7/16" open end wrench or ratchet & socket
- 9/16" open end wrench
- adjustable wrench
- #2 Phillips screwdriver
- flat blade screwdriver

WASHER INSTALLATION

Washer Installation Kit

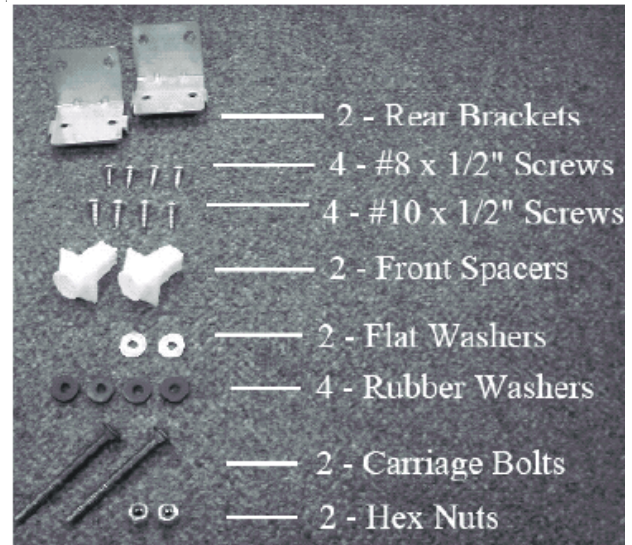

1. Remove the washer installation hardware from the plastic bag.
2. Attach the rear brackets to the pedestal with four #8 screws (2 per bracket).

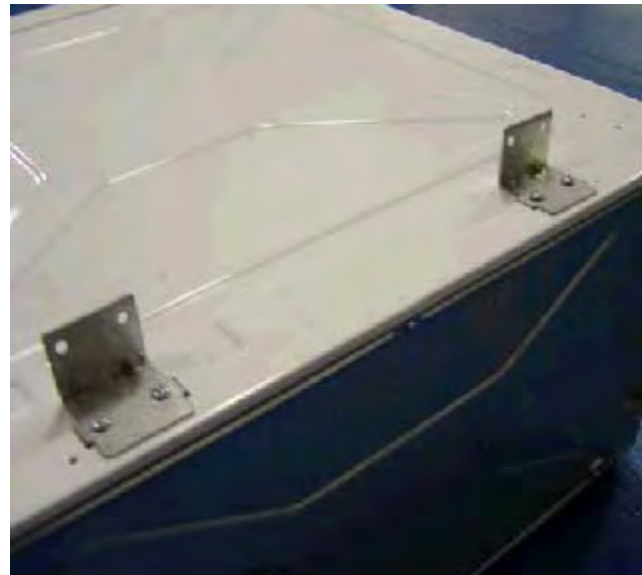

3. Remove the front service panel from the washer. Using two or more people, carefully lift the washer onto the pedestal and set flush against the rear brackets as shown.

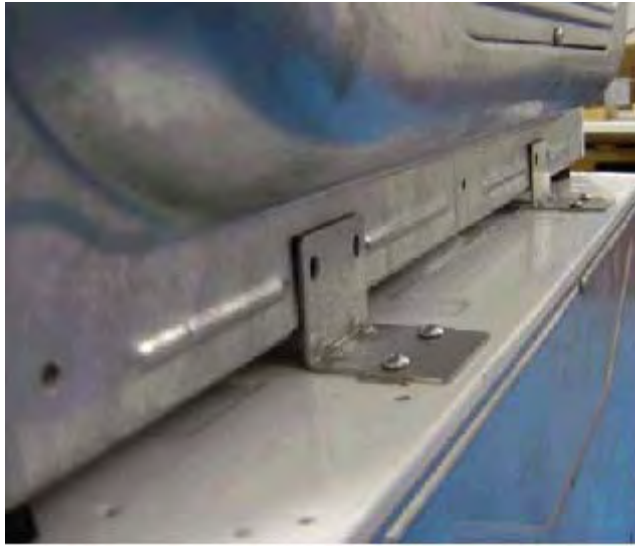

NOTE: If washer was previously installed, disconnect power cord, remove inlet hoses from water faucets and tape the drain hose to the top of the washer to eliminate excess water on the floor. Also, make sure the leveling legs are adjusted fully into the washing machine.

4. Align the sides of the washer with the sides of the pedestal and attach the washer to the rear brackets using four #10 screws (2 per bracket).



5. Open the drawer of the pedestal; assemble a carriage bolt through a front spacer and rubber washer.



6. Insert the bolt/spacer assembly up through the pedestal with the front spacer positioned in the square hole of the pedestal and the bolt coming through the slotted hole in the washing machine base.
7. Install a rubber washer, flat washer and hex nut onto the carriage bolt. Tighten the hex nut.



DRYER INSTALLATION

Dryer Installation Kit



8. Repeat installation of bolt/spacer assembly for the other side.
9. After closing the pedestal drawer, carefully move the washer/pedestal assembly into position. **NOTE: Because of the increased weight caused by the addition of the pedestal, two or more people may be required.**

NOTE: The washer/pedestal assembly MUST be on a solid floor and level for proper operation. After leveling the washer/pedestal assembly, adjust the lock nut on each leveling leg against the pedestal base and tighten with a wrench. Keep the leg extension at a minimum to prevent excessive vibration.

10. Refer to the installation instructions that came with the washer to properly complete electrical, water, and drain connections. If questions arise, please refer to the Owner's Guide that came with the washer for contact information.

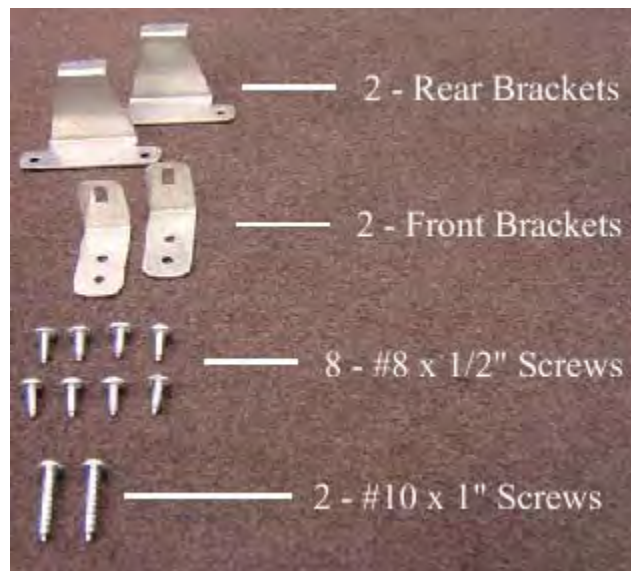

1. Remove the dryer installation hardware from the plastic bag.
2. Attach the rear brackets to the pedestal with four #8 screws (2 per bracket).

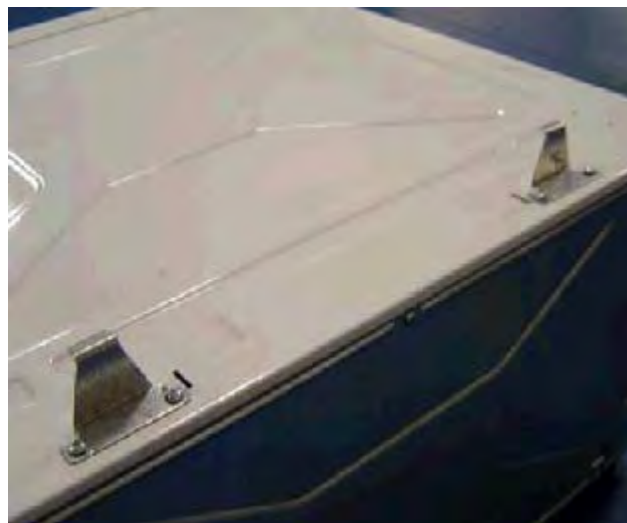

3. Attach the front brackets to the pedestal with four #8 screws (2 per bracket).



NOTE: If dryer was previously installed, disconnect power cord and vent hose. Also, make sure the leveling legs are adjusted fully into the dryer.

4. Using two or more people, carefully lift the dryer onto the pedestal, tilting the dryer back slightly to engage the slots in the rear of the dryer with the tabs of the rear brackets on the pedestal.



5. Set the dryer down onto the pedestal making sure the service panel bracket on the dryer is behind the front brackets of the pedestal.

6. With the pedestal drawer open for better access, install the two #10 screws through the front brackets in the pedestal into the service panel bracket of the dryer.



7. After closing the pedestal drawer, carefully move the dryer/pedestal assembly into position.

NOTE: Because of the increased weight caused by the addition of the pedestal, two or more people may be required.

NOTE: The dryer/pedestal assembly MUST be on a solid floor and level for proper operation. After leveling the dryer/pedestal assembly, adjust the lock nut on each leveling leg against the pedestal base and tighten with a wrench. Keep the leg extension at a minimum to prevent excessive vibration.

8. Refer to the installation instructions that came with the dryer to properly complete electrical and venting connections. If questions arise, please refer to the Owner's Guide that came with the dryer for contact information.

WARRANTY

Full One Year Warranty on Mechanical Parts

Sample warranty - always check warranty with product

For one year from date of purchase, when this pedestal is installed with the listed washer or dryer (see owners manual for specific model) and operated according to the information in the Use and Care Guide, Operating Instructions and Installation Instructions, the supplier will replace any of its mechanical parts if they are defective in workmanship or material. Keep your bill of sale. The date of the bill establishes the warranty period should parts be required. This written warranty gives you specific rights. You may also have other rights which vary from state to state.

Warranty Restriction

If the pedestal is used for any other purpose than private family use or used with any product that requires modification for installation, the warranty is null and void.

Warranty Parts

Warranty parts are available by contacting the supplier where the pedestal was purchased or refer to the Use and Care Guide that came with the washer or dryer that is installed on the pedestal for contact information.

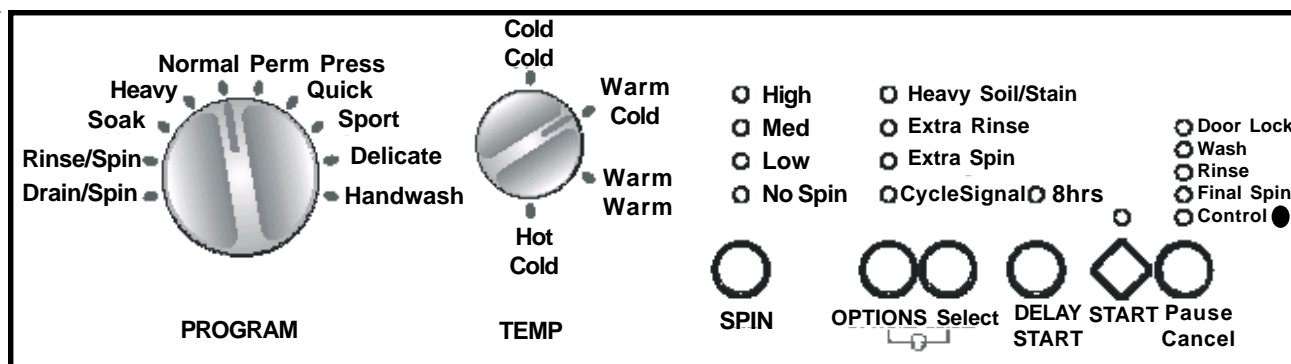

SECTION C - OPERATING INSTRUCTIONS

Before Operating Your Washer

Read your washer Owner's Guide. It has important safety and warranty information. It also has many suggestions for best washing results.

WARNING To reduce the risk of fire, electric shock or injury to persons, read the IMPORTANT SAFETY INSTRUCTIONS in your washer Owner's Guide before operating this appliance.

Operating Steps

Read and follow "Washing Procedures" in your Owner's Guide. It provides detailed information for preparing the wash load and choosing control settings to ensure best washing results.

1. Sort laundry into loads that can be washed together.
2. Prepare items for washing.
3. Pretreat stains and heavy soil.
4. Add laundry load to the wash drum.
5. Add laundry products to the dispenser.
 - Detergent, bleach and fabric softener will be dispensed at the proper time in the cycle.
 - Slide safety latch to the right to open the dispenser drawer.
 - Add recommended amount of high efficiency detergent to the detergent compartment. 
 - If desired, add liquid chlorine bleach and liquid fabric softener to the appropriate compartments.
 - Slowly close dispenser drawer. The washer will not operate with the drawer open.

- Any water remaining in the dispenser at the end of the cycle is a result of siphoning action and part of normal operation.
6. Select the appropriate cycle and temperature for the load.
 - Turn the PROGRAM knob to select the cycle.
 - Turn the TEMP knob to select the wash and rinse temperatures.
 - If the water temperature combination is not appropriate for that cycle, the status lights will blink and the signal will beep 3 times.
 7. The suitable final spin speed and options for that cycle will automatically be displayed.
 - To change the final spin speed, press SPIN until the indicator for the desired selection is lighted.
 - To select or delete an option, press OPTIONS, then SELECT. The indicator light will stop blinking when the option has been selected. It will not light if the option is not available for that cycle.
 - Adjustments to the cycle will be remembered each time that cycle is selected in the future.
 - See "Washer Settings Chart" chart for factory settings.

Note: To provide the best care for your laundry items, not every temperature, speed and option is available with every cycle.

8. Select DELAY START to delay the beginning of the cycle for 8 hours.
9. Start the washer.
 - Close the door and press START. The washer will not operate with the door open.
 - As a safety measure, the door will automatically lock during the entire wash cycle and the DOOR LOCK indicator will be lighted.

- To pause the cycle or change settings, press PAUSE/CANCEL once.
- If the cycle is interrupted during spin, it will take approximately 2-3 minutes for the door lock to release. DO NOT force the door open.
- To stop the washer, press PAUSE/CANCEL twice.

10. A signal will sound when the cycle signal option is selected. Remove items when cycle ends.

Cycle Selection

Turn PROGRAM knob until desired cycle is selected. For best results, follow the fabric care label instructions on items to be washed.

Heavy

This cycle provides 16 minutes of reversing tumble wash action for heavily soiled regular items, followed by 3 rinses plus an automatic extra rinse and a final spin. Hot water is recommended to remove heavy soil and most stains. Heavy Soil/Stain and Extra Spin are available options.

Normal

Normal Cycle provides 13 minutes of reversing tumble wash action for normally soiled loads followed by 3 rinses and a final spin. Heavy Soil/Stain, Extra Rinse and Extra Spin are available options.

Perm Press

Perm Press Cycle provides 10 minutes of reversing tumble wash action for cottons and blends with a no-iron finish followed by a Cool Down rinse, 2 additional rinses and a final spin. To minimize wrinkling, the Warm Rinse and Extra Spin are not available with this cycle. Heavy Soil/Stain and Extra Rinse options can be selected.

Quick

Quick Cycle provides 5 minutes of reversing tumble wash action for lightly soiled items that must be laundered quickly, followed by 2 rinses and a final spin. To save time, Heavy Soil/Stain, Extra Rinse and Extra Spin options are not available in this cycle.

Sport

This cycle is designed for small loads of lightweight, synthetic apparel worn for working out, running, swimming, cycling, tennis and similar activities when removal of light soil and perspiration are important. Items will tumble occasionally as they soak for 10 minutes.

Reversing tumble wash action will continue for 6 minutes followed by 3 rinses and a final spin. For best results, select a detergent that contains enzymes and the hottest wash water safe for the load. Add a detergent booster, color safe bleach or odor eliminator with the detergent if needed. Chlorine bleach should not be used on items containing Lycra™. Fabric softeners reduce wicking and are not recommended for garments made to pull moisture away from the body.

Delicate

This cycle provides 10 minutes of gentle reversing tumble wash action for knits and delicates, followed by 3 rinses and a final spin. To protect your delicate items, a hot water wash is not available. Extra Rinse is an available option.

Handwash

Select the Handwash Cycle for items labeled "Hand Washable". Ten minutes of occasional tumbling are followed by 3 rinses and a slow final spin. To protect your hand washables, a hot water wash, Heavy Soil/Stain and Extra Spin are not available options. Extra Rinse is an available option.

Soak

Use this cycle to soak heavily soiled and stained items before washing. Only cold water is available with this cycle because warmer water may set some stains. Add half the detergent dose and a detergent booster, if desired, to the detergent compartment. Six minutes of regular reversing tumble wash action are followed by 30 minutes of occasional tumbling as the load soaks. The water will drain out and the load will spin slowly for several minutes. Follow Soak with a complete wash cycle suitable for the load and a full detergent dose.

Drain/Spin

Use the Drain/Spin cycle as a follow-up to a No Spin selection or anytime you want to drain water from the washer and spin out the load. Select the spin speed appropriate to the load.

Rinse/Spin

Select Rinse Spin for loads that need a cold water rinse or to add fabric softener that may have been omitted in a regular cycle. Add the fabric softener to the dispenser chamber if desired. Select the spin speed appropriate for the load.

Note: To change cycle, press PAUSE/CANCEL twice.

Cycle Settings

Turn the TEMP knob and press SPIN until the desired wash and rinse water temperatures and final spin speed are selected. If the water temperature combination is not appropriate for that cycle, the status lights will blink and the signal will beep 3 times. Settings cannot be changed after the cycle starts unless you pause the program first. Adjustments to the cycle will automatically be remembered each time that cycle is used.

Wash / Rinse Water Temperatures

Select the wash and rinse water temperatures appropriate for each load.

- **Hot/Cold** for heavily soiled, white/colorfast cotton and perm press loads.
- **Warm/Cold** for normally soiled, white/colorfast, cotton and perm press loads.
- **Cold/Cold** for lightly soiled, non-colorfast items, knits, delicates and hand washables.
- **Warm/Warm** for washable woolsens.

Final Spin Speed

The suitable final spin speed for each cycle will automatically be displayed. The speeds will vary from cycle to cycle. For example, High Speed in the Normal cycle is much faster than High Speed in the Handwash cycle. To change the final spin speed, press SPIN until the indicator for the desired selection is lighted. If a spin speed is not recommended for a cycle, it will not be displayed.

- Increasing spin speed will extract more water and decrease drying time.
- Decreasing spin speed will reduce wrinkling.
- Use **NO SPIN** to omit the final spin at the end of the cycle. The load will be very wet. Remove items from wash drum to drip dry or select DRAIN/SPIN to remove excess water at a more convenient time.

Water Level

There is no need to select a water level. The washer automatically adjusts the water level to the type and size of wash load.

Cycle Options

To select Heavy Soil/Stain, Extra Spin, Extra Rinse or Cycle Signal, press OPTIONS until the light indicates

the desired option. Then press SELECT to add that option to the cycle. To delete an indicated option, press SELECT again. To provide the best care for your laundry items, all options are not available with every cycle.

Heavy Soil / Stain

Use this option to add approximately 2 minutes of wash time for very soiled or stained loads.

Extra Rinse

Use this option when additional rinsing is desired to remove excess dirt and detergent. It is recommended for heavily soiled loads or if household members have sensitive skin. Extra Rinse occurs before the final rinse when the liquid fabric softener is dispensed.

Extra Spin

Use this option to add several additional minutes to the final spin at the selected speed. This will improve water extraction and decrease drying time.

Cycle Signal

A signal will sound at the end of the cycle when the cycle signal is selected.

Washer Features

Delay Start

Press the Delay Start to select a wash time convenient to your schedule or during off peak energy hours. The start of the cycle can be delayed for 8 hours.

Control (Control Lock)

To avoid having someone accidentally start or stop the washer, press OPTIONS and SELECT at the same time until the Control  (Control Lock) indicator is lighted. To unlock the controls, press OPTIONS and SELECT again.

Status Lights

The following will be displayed during the cycle:

- Door Lock
- Wash
- Rinse
- Final Spin
- Control  (Control Lock)

WASHER SETTINGS CHART

The following chart shows the temperatures, spin speeds and options available for each cycle.

	Heavy	Normal Cycle	Perm Press	Quick cycle	Delicate	Handwash	Soak	Sport	Drain Spin	Rinse Spin
Temperatures										
Cold/Cold	X	X	X	X	X	*X	*X	X		*X
Warm/Cold	X	*X	*X	*X	*X	X		*X		X
Warm/Warm	X	X		X	X	X		X		X
Hot/cold	*X	X	X	X						
Speed										
High Spin	*X	*X	*X	*X	*X	*X	*X	*X	*X	*X
Medium Spin	X	X	X	X	X	X	X	X	X	X
Low Spin	X	X	X	X	X	X	X	X	X	X
No Spin	X	X	X	X	X	X	X	X		X
Options										
Cycle Signal	*X	*X	*X	*X	*X	*X	*X	*X	*X	*X
Heavy Soil/stain	X	X	X							
Extra Rinse	*X	X	X		X	X		X		
Extra Spin	X	X						X		
Delay Start	X	X	X	X	X	X	X	X	X	X

* Factory Settings X Available Settings

ERROR CODE CHART

If the washer stops, an error code flashes and the signal beeps periodically, press Pause Cancel. Consult the error code chart below or the "Avoid Service Checklist in the owner guide for the possible cause and solution. Make correction, then select a cycle and press start. If the error code flashes again and the beeping continue, please contact service for assistance.

Beeps	Error	Causes Possibles	Solutions
1	Water doesn't enter	Water supply to home is interrupted. Water pressure is too low. Water may not be turned on or faucets may not be fully opened. Hose are kinked	Check to see if the water flows adequately from the other faucets in the home; wait for service to be restored. Avoid running water in other areas of the home when doing laundry. Fully open supply faucets to washer. Straighten hoses.
1	Water leaks	Hoses connections are loose. Household drain is clogged. Oversudsing	Tighten inlet hose connections at faucets and washer. Unclog household drain. Use high efficiency detergent in amount recommended on label.
1			
2	Dispenser drawer is open	Washer will not operate if the dispenser drawer is open.	Close dispenser drawer.
3	Water doesn't drain	Drain hose is kinked. Household drain is clogged.	Straighten hoses. Unclog household drain.
4	Drum overfilled	Inlet valve, pressure switch or control board failure.	Do not open door. Select Drain/Spin to remove the water. Restart cycle.
5	Door open	Washer will not operate if the door is open.	Close washer door.
7	Motor is overheated	Washer motor stops if overheated.	Wait 30 minutes for the motor to cool down.
15	Cold water doesn't enter washer	Cold water hose is connected to the wrong faucet. Cold water faucet is turned off.	Connected the hose to the cold water faucet and the cold inlet on the washer. Be sure the cold water faucet is fully opened.
15	Oversudsing	A high efficiency detergent was not used. Too much detergent was added.	Use only high efficiency detergent. Follow manufactures recommendation for dosage. Amount may need to be adjusted for water temperature, water hardness, load size and soil level.
	Hot water doesn't enter	Hot water hose is connected to the wrong faucet. Hot water faucet is turned off.	Connected the hose to the hot water faucet and the hot inlet on the washer. Be sure the hot water faucet is fully opened.

SECTION D - OWNER GUIDE

Product Record

In the space below, record the date of purchase, model and serial number of your product. You will find the model and serial number printed on an identification plate located at the top, inside of the door opening.

Model No. _____

Serial No. _____

Date of Purchase _____

Save these instructions and your sales receipt for future reference.

This Use and Care Guide provides general operating instructions for your washer. It also contains information about features for several other models. Your washer may not have every feature included here.

Use the washer only as instructed in this Use and Care Guide and the **Operating Instructions** card included with your washer.

Your safety and the safety of others is very important.

We have provided many important safety messages in the Use and Care Guide, Operating Instructions, Installation Instructions and on your appliance. Always read and obey all safety messages.

 This is the safety alert symbol. This symbol alerts you to hazards that can kill or hurt you or others. All safety messages will be preceded by the safety alert symbol and the word "DANGER" or "WARNING". These words mean:

 **DANGER** You will be killed or seriously injured if you don't follow instructions.

 **WARNING** You can be killed or seriously injured if you don't follow instructions.

All safety messages will identify the hazard, tell you how to reduce the chance of injury, and tell you what can happen if the instructions are not followed.

Pedestal

A pedestal accessory specifically designed for this washer may be used when elevating the washer for ease of use. Failure to use accessories certified by the manufacturer could result in personal injury, property damage or damage to the washer.

Important Safety Instructions

Read all instructions before using this washer.

 **WARNING** To reduce the risk of fire, electrical shock, or injury to persons when using this washer, comply with the basic warnings listed.

 Failure to comply with these warnings could result in serious personal injuries.

Prevent Fire

 **WARNING** Do not wash items that have been previously cleaned in, soaked in, or spotted with gasoline, cleaning solvents, kerosene, cooking oils, waxes, etc. Do not store these items on or near the washer. These substances give off vapors or chemical reactions that could ignite or explode.

 **WARNING** Do not put oily or greasy rags or clothing on top of the washer. These substances give off vapors that could ignite the materials.

 **WARNING** Do not add gasoline, cleaning solvents, or other flammable or explosive substances to the wash water. These substances give off vapors that could ignite or explode.

 **WARNING** Under certain conditions, hydrogen gas may be produced in a hot water system that has not been used for 2 weeks or more. **HYDROGEN GAS IS EXPLOSIVE.** If the hot water system has not been used for such a period, before using the washer, turn on all hot water faucets and let the water flow from each for several minutes. This will release any accumulated hydrogen gas. Hydrogen gas is flammable; do not smoke or use an open flame during this time.

 **WARNING** Do not store or use gasoline or other flammable vapors or liquids in the vicinity of this or any other appliance.

 Failure to comply with these warnings could result in fire, explosion, serious bodily injury and/or damage to the rubber or plastic parts of the washer.

Protect Children

 **WARNING** Do not allow children to play on or in the washer. Close supervision of children is necessary when the washer is used near children. As children grow, teach them the proper, safe use of all appliances.

⚠ WARNING Destroy the carton, plastic bag and other packing materials after the washer is unpacked. Children might use them for play. Cartons covered with rugs, bedspreads or plastic sheets can become airtight chambers.

⚠ WARNING Keep laundry products out of children's reach. To prevent personal injury, observe all warnings on product labels.

⚠ WARNING Before the washer is removed from service or discarded, remove the washer door to prevent accidental entrapment.

⚠ Failure to comply with these warnings could result in serious personal injuries.

⚠ WARNING Avoid fire hazard or electrical shock. Do not use an adaptor plug or extension cord or remove grounding prong from electrical power cord. Failure to follow this warning can cause serious injury, fire or death.

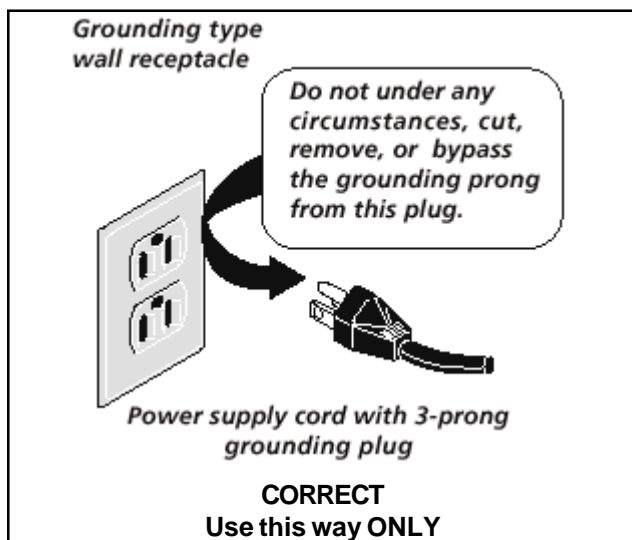

⚠ WARNING Do not use or mix liquid chlorine bleach with other household chemicals such as toilet cleaners, rust removers, acid or products

containing ammonia. These mixtures can produce dangerous fumes which can cause serious injury or death.

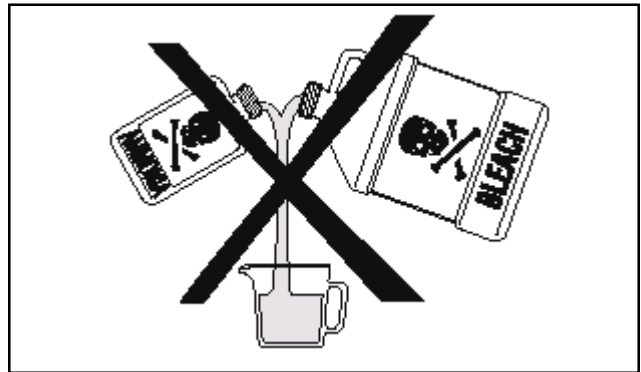

Note: The instructions appearing in this Owner's Guide are not meant to cover every possible condition and situation that may occur. Common sense and caution must be practiced when installing, operating and maintaining any appliance.

Prevent Injury

⚠ WARNING To prevent shock hazard and assure stability during operation, the washer must be installed and electrically grounded by a qualified service person in accordance with local codes. Installation instructions are packed in the washer for installer's reference. Refer to INSTALLATION INSTRUCTIONS for detailed grounding procedures. If the washer is moved to a new location, have it checked and reinstalled by a qualified service person.

⚠ WARNING To prevent personal injury or damage to the washer, the electrical power cord of the washer must be plugged into a properly grounded and polarized 3-prong outlet. **The third grounding prong must never be removed. Never ground the washer to a gas pipe. Do not use an extension cord or an adaptor plug.**

⚠ WARNING Follow package directions when using laundry products. Incorrect usage can produce poisonous gas--resulting in serious injury or death.

- **Do not** combine laundry products for use in 1 load unless specified on the label.
- **Do not** mix chlorine bleach with ammonia or acids such as vinegar.

⚠ WARNING To prevent serious personal injury and damage to the washer:

- **All repairs and servicing must be performed by an authorized servicer** unless specifically recommended in this Owner's Guide. Use only authorized factory parts.
- **Do not** tamper with controls.
- **Do not** install or store the washer where it will be exposed to the weather.
- **Do not** install on carpet. Install washer on a solid floor. It may be necessary to reinforce the floor to prevent vibration or movement.

⚠ WARNING To reduce the risk of electric shock, disconnect this appliance from the power supply before attempting any user maintenance. Turning the controls to the OFF position does not disconnect this appliance from the power supply.

⚠ WARNING To prevent injury, do not reach into the washer while parts are moving. Before loading, unloading or adding items, push in the cycle selector knob and allow the drum to coast to a complete stop before reaching inside.

⚠ Failure to comply with these warnings could result in serious personal injuries.

⚠ This washer is equipped with an electrical overload protector. The motor will stop if it becomes overheated. The washer will automatically restart after a cool down period of up to 30 minutes, if the washer has not been manually turned off during this time.

SAVE THESE INSTRUCTIONS



As an ENERGY STAR Partner,® Electrolux Home Products has determined that this product meets the ENERGY STAR® guidelines for energy efficiency.

Washing Procedures

- Follow the guidelines below for preparing the wash load.
- Read the **Operating Instructions** card for operating your specific model.

- **Always read and follow fabric care and laundry product labels.**

⚠ WARNING To reduce the risk of fire, electrical shock, or injury to persons, read **Important Safety Instructions**, before operating this washer.

1. Sort laundry into loads that can be washed together.

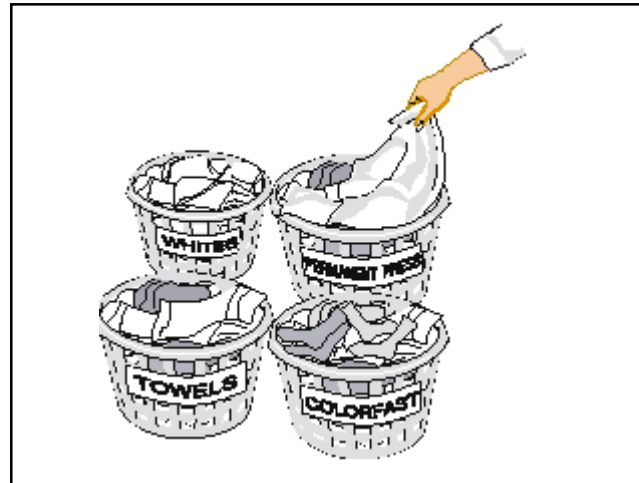

Sort items by recommended water temperatures and wash time.

- Separate white, light, and colorfast items from dark and non-colorfast items.
- Separate items which shed lint from items which attract lint. Permanent press, synthetic, knit and corduroy items will pick up lint from towels, rugs and chenille bedspreads.
- Separate heavily soiled items from lightly soiled items.
- Separate lacy, sheer and loosely knit items from sturdy items.
- Do not machine wash items containing fiberglass. Small particles of fiberglass left in the drum may stick to fabrics in other loads and cause skin irritation.

2. Prepare items for washing.

- Empty pockets.

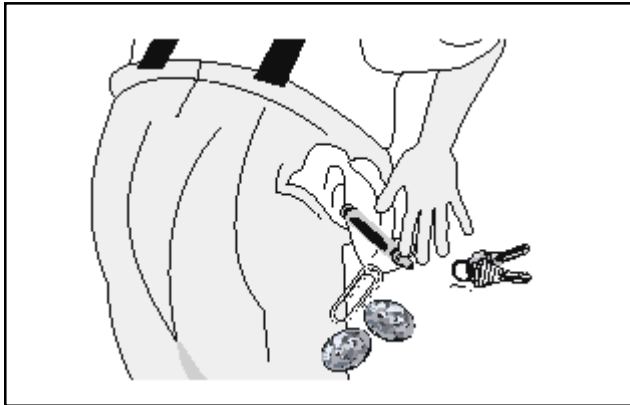

- Brush off lint and dirt. Shake out rugs and beach towels.
- Close zippers, fasten hooks, tie strings and sashes, and remove nonwashable trims and ornaments.
- Remove pins, decorative buttons, belt buckles, and other objects which could be damaged. This also helps protect other items in the wash load.
- Mend rips and tears to prevent further damage during washing.
- Place delicate items such as bras, shoulder pads, hosiery, and belts in a mesh bag to prevent tangling during the wash cycle.

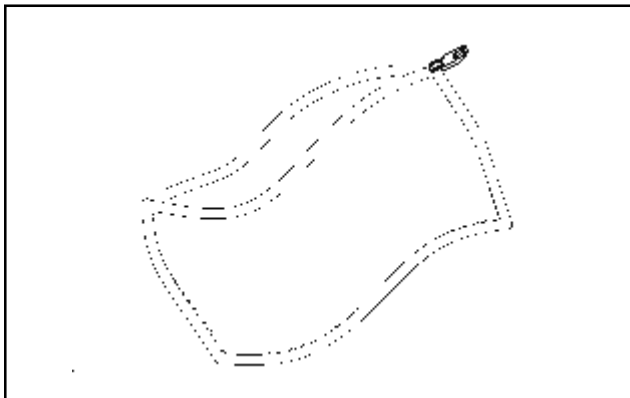

- Turn knit items inside out to prevent pilling.

3. Pretreat stains and heavy soil.

See **Stain Removal**.

4. Add laundry load to washer.

- Combine large and small items in a load. Load large items first. Large items should not be more than half the total wash load.

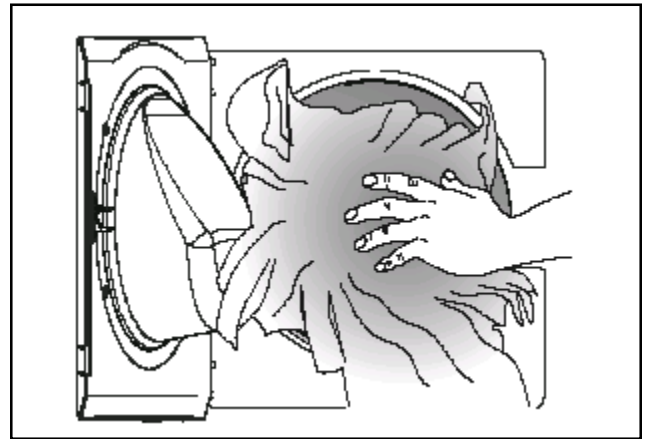

- Washing single items such as a sweater, towel or jeans may cause an out-of-balance load. Add 1 or 2 similar items to help balance the load.
- Single heavy items such as a bedspread can be washed separately.
- The washer can be fully loaded, but the items should not be tightly packed. The door should close easily.

5. Add detergent, bleach and fabric softener to automatic dispenser following these steps:

A. OPENING AND CLOSING THE DISPENSER DRAWER

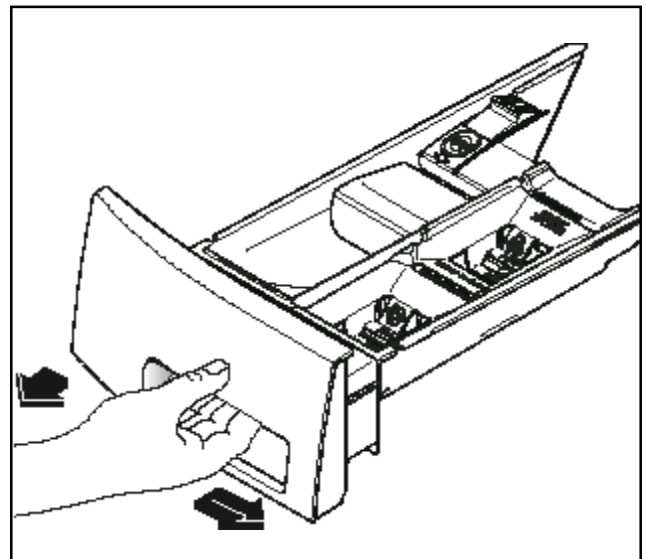

- Slowly open the dispenser drawer by first sliding the safety latch to the right, then pulling the drawer out until it stops.
- After adding laundry products, slowly close the dispenser drawer. Closing the drawer too quickly could result in early dispensing of the bleach and fabric softener.

B. DETERGENT

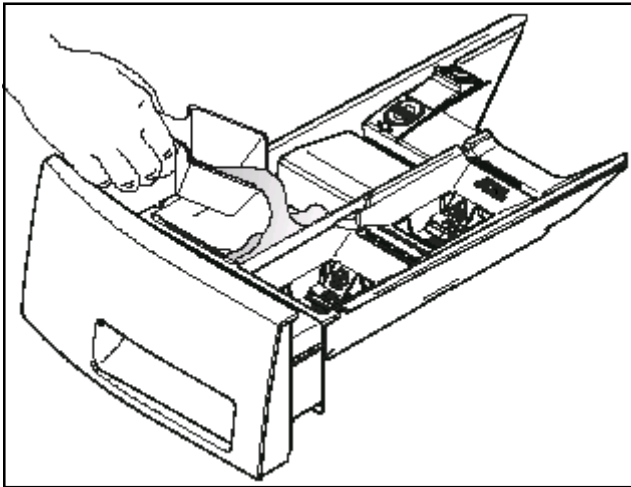



- Detergent is flushed from the dispenser at the beginning of the cycle. Either powdered or liquid detergent can be used.

Note: Liquid detergent will drain into the washer drum as it is added.

- Add a low-sudsing, high-efficiency detergent made for front-loading washers to the dispenser chamber. Look for this symbol on the detergent label. Use the cap or scoop provided by the detergent manufacturer to measure the amount recommended. 
- Color-safe bleach, water conditioner, detergent booster and enzyme products may be added to the detergent compartment. Avoid mixing liquids and powders.
- Detergent usage may need to be adjusted for water temperature, water hardness, load size and soil level.
- For best results, avoid oversudsing.

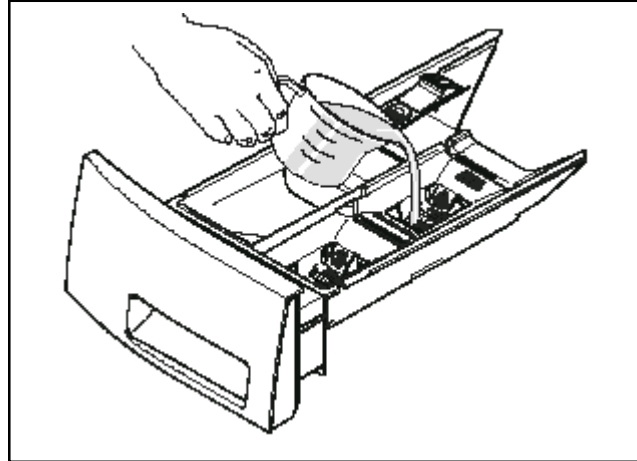
C. LIQUID BLEACH



- If desired, measure out the recommended amount of liquid chlorine bleach (not to exceed 1/3 cup (80 ml)) and pour it into the center compartment labeled "Liquid Bleach" and marked with this symbol. 
- Fill to the minimum fill line (MIN) for small loads. Fill to the maximum fill line (MAX) for large loads. Do not exceed the maximum fill line. Overfilling can cause early dispensing of the bleach which could result in damaged clothes.
- Do not pour undiluted liquid chlorine bleach directly onto the load or into the drum. Fabric damage can occur.
- **Add powder or liquid color-safe bleach to the detergent dispenser.**

D. FABRIC SOFTENER

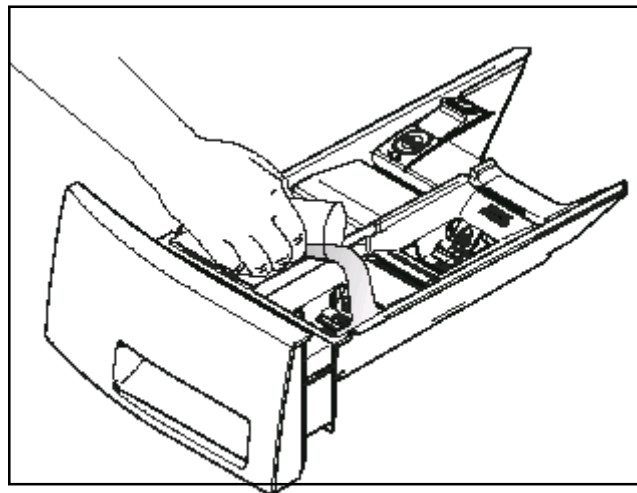

- If desired, pour the recommended amount of

fabric softener into the compartment labeled “Fabric Softener” and marked with this symbol.



- Fill to the minimum fill line (MIN) for small loads. Fill to the maximum fill line (MAX) for large loads. Do not exceed the maximum fill line. Overfilling can cause early dispensing of the fabric softener which could result in stained clothes.
- **Do not pour fabric softener directly on the wash load.**
- Use of a fabric softener dispensing ball is not recommended in tumble action washers.

6. Select the cycle, temperature, spin speed, options and features according to type, size, and soil level of each load. Start the washer.

(See **Operating Instructions** for your specific model.)

7. Remove items when the cycle is completed.

Place washed items in automatic dryer, line dry, or dry flat as directed by fabric care label. Excess wrinkling, color transfer or odors may develop in items left in the washer after the cycle has ended.

8. General Precautions.

- **If the dispenser drawer is opened during operation, the washer will shut off.** Slowly close the dispenser drawer, and press START to continue cycle.
- **Do not slam the washer door closed or try to force the door open when DOOR LOCK light is on.** This could result in damage to the washer.

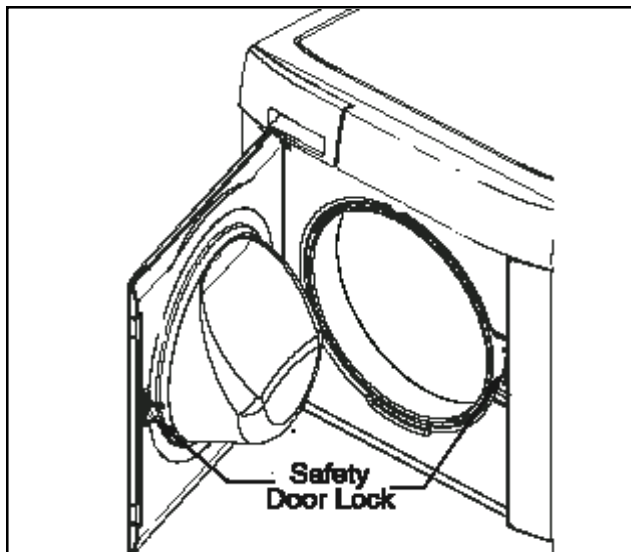

- **DO NOT leave the washer door open.** An open door could entice children to hang on the door or crawl inside the washer.

Note: If there are no small children present, leave the door ajar to prevent odor build up.

- To avoid damaging the washer and personal injury, DO NOT hang on or lean against the washer door.
- Do not place detergent, bleach or fabric softener containers on top of the washer. They can damage the finish or controls.

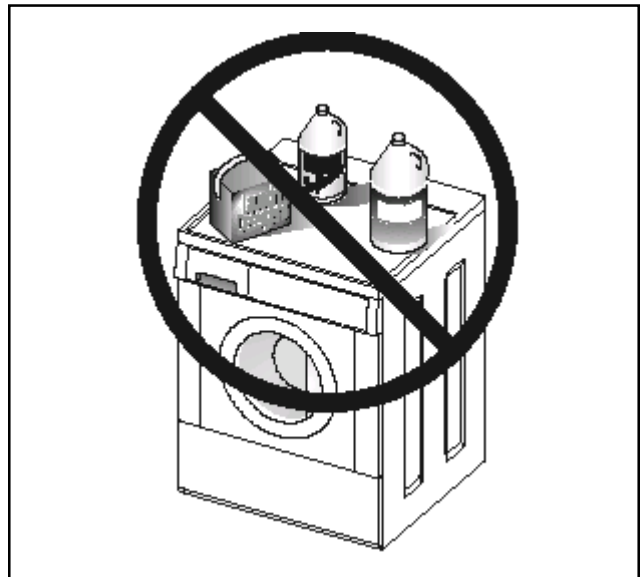

Stain Removal

WARNING Do not use or mix liquid chlorine bleach with other household chemicals such as toilet cleaners, rust removers, acid or products containing ammonia. These mixtures can produce dangerous fumes which can cause serious injury or death.

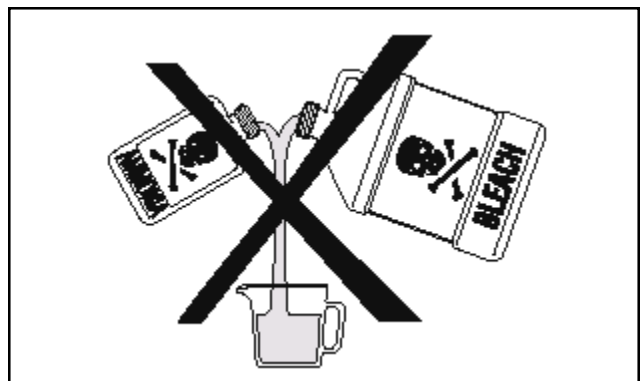

Safe Stain Removal Procedures

⚠ WARNING To reduce the risk of fire or serious injury to persons or property, comply with the basic warnings listed below:

- Read and comply with all instructions on stain removal products.
- Keep stain removal products in their original labeled containers and out of children's reach.
- Thoroughly wash any utensil used.
- Do not combine stain removal products, especially ammonia and chlorine bleach. Dangerous fumes may result.
- Never wash items which have been previously cleaned in, washed in, soaked in or spotted with gasoline, dry cleaning solvents or other flammable or explosive substances because they give off vapors that could ignite or explode.
- Never use highly flammable solvents, such as gasoline, inside the home. Vapors can explode on contact with flames or sparks.

For successful stain removal:

- Remove stains promptly.
- Determine the kind of stain, then follow the recommended treatment in the stain removal chart below.
- To pretreat stains, use a prewash product, liquid detergent, or a paste made from granular detergent and water.
- Use cold water on unknown stains because hot water can set stains.
- Check care label instructions for treatments to avoid on specific fabrics.
- Check for colorfastness by testing stain remover on an inside seam.
- Rinse and wash items after stain removal.

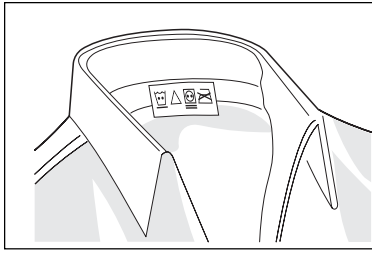

Follow fabric care label instructions.

For successful stain removal:

- Remove stains promptly.
- Determine the kind of stain, then follow the recommended treatment in the stain removal chart below.
- To pretreat stains, use a prewash product, liquid detergent, or a paste made from granular detergent and water.
- Use cold water on unknown stains because hot water can set stains.
- Check care label instructions for treatments to avoid on specific fabrics.
- Check for colorfastness by testing stain remover on an inside seam.
- Rinse and wash items after stain removal.

STAIN REMOVAL	
Stain	Treatment
Adhesive tape, chewing gum, rubber cement	Apply ice. Scrape off excess. Place stain face down on paper towels. Saturate with prewash stain remover or nonflammable dry cleaning fluid.
Baby formula, dairy products, egg	Use product containing enzymes to pretreat or soak stains. Soak for 30 minutes or more. Wash.
Beverages (coffee, tea, soda, juice, alcoholic beverages)	Pretreat stain. Wash using cold water and bleach safe for fabric.
Blood	Rinse with cold water. Rub with bar soap. Or, pretreat or soak with product containing enzymes. Wash using bleach safe for fabric.
Candle wax, crayon	Scrape off surface wax. Place stain face down between paper towels. Press with warm iron until wax is absorbed. Replace paper towels frequently. Treat remaining stain with prewash stain remover or nonflammable dry cleaning fluid. Hand wash to remove solvent. Wash using bleach safe for fabric.
Chocolate	Pretreat or soak in warm water using product containing enzymes. Wash using bleach safe for fabric.
Collar or cuff soil, cosmetics	Pretreat with prewash stain remover or rub with bar soap.
Dye transfer on white fabric	Use packaged color remover. Wash using bleach safe for fabric.
Grass	Pretreat or soak in warm water using product containing enzymes. Wash using bleach safe for fabric.
Grease, oil, tar (butter, fats, salad dressing, cooking oils, car grease, motor oils)	Scrape residue from fabric. Pretreat. Wash using hottest water safe for fabric. For heavy stains and tar, apply nonflammable dry cleaning fluid to back of stain. Replace towels under stain frequently. Rinse thoroughly. Wash using hottest water safe for fabric.
Ink	Some inks may be impossible to remove. Washing may set some inks. Use prewash stain remover, denatured alcohol or nonflammable dry cleaning fluid.
Mildew, scorch	Wash with chlorine bleach if safe for fabric. Or, soak in oxygen bleach and hot water before washing. Badly mildewed fabrics may be permanently damaged.
Mud	Brush off dry mud. Pretreat or soak with product containing enzymes.
Mustard, tomato	Pretreat with prewash stain remover. Wash using bleach safe for fabric.
Nail polish	May be impossible to remove. Place stain face down on paper towels. Apply nail polish remover to back of stain. Repeat, replacing paper towels frequently. Do not use on acetate fabrics.
Paint, varnish	WATER BASED: Rinse fabric in cool water while stain is wet. Wash. Once paint is dry, it cannot be removed. OIL BASED AND VARNISH: Use solvent recommended on can label. Rinse thoroughly before washing.
Perspiration	Use prewash stain remover or rub with bar soap. Rinse. Wash using nonchlorine bleach in hottest water safe for fabric.
Rust, brown or yellow discoloration	For spots, use rust remover safe for fabric. For discoloration of an entire load, use phosphate detergent and nonchlorine bleach. Do not use chlorine bleach because it may intensify discoloration.
Shoe polish	LIQUID: Pretreat with a paste of granular detergent and water. PASTE: Scrape residue from fabric. Pretreat with prewash stain remover or nonflammable dry cleaning fluid. Rinse. Rub detergent into dampened area. Wash using bleach safe for fabric.
Urine, vomit, mucus, feces	Pretreat or soak in product containing enzymes. Wash using bleach safe for fabric.

COMMON WASHING PROBLEMS

Many washing problems involve poor soil and stain removal, residues of lint and scum, and fabric damage. For satisfactory washing results, follow these suggestions provided by The Soap and Detergent Association.

PROBLEM	POSSIBLE CAUSES	SOLUTIONS	PREVENTIVE MEASURES
Blue stains	<ul style="list-style-type: none"> • Undiluted liquid detergent or fabric softener dispensed directly onto fabric. 	<ul style="list-style-type: none"> • If caused by detergent, mix 1 cup (240 ml) white vinegar with 1 quart (.95 L) water in plastic container. Soak item 1 hour. Rinse. • If caused by fabric softener, rub stains with bar soap. Wash. 	<ul style="list-style-type: none"> • Avoid overfilling detergent and fabric softener compartments of dispenser.
Discoloration, graying	<ul style="list-style-type: none"> • Not enough detergent. • Wash temperature too low. • Incorrect sorting. 	<ul style="list-style-type: none"> • Rewash with correct amount of detergent and hottest water safe for fabric. Add bleach safe for fabric. 	<ul style="list-style-type: none"> • Sort items by soil level and color. • Use correct amount of detergent, hottest water and bleach safe for fabric.
Greasy, oily stains	<ul style="list-style-type: none"> • Not enough detergent. • Undiluted liquid fabric softener poured directly on fabric. 	<ul style="list-style-type: none"> • Treat with prewash stain remover or liquid detergent. • Increase detergent and water temperature. Rewash. • Rub fabric softener stains with bar soap. 	<ul style="list-style-type: none"> • Use correct amount of detergent and hottest water safe for fabric. • Do not pour liquid fabric softener directly on fabric. See Washing Procedures on adding softener.
Holes, tears, or snags	<ul style="list-style-type: none"> • Incorrect use of chlorine bleach. • Unfastened zippers, hooks, buckles. • Rips, tears and broken threads. • Overloading the washer. • Degradation of fabric. 	<ul style="list-style-type: none"> • May be irreversible if rips, tears and seams cannot be mended. 	<ul style="list-style-type: none"> • Never pour chlorine bleach directly on fabric. • Check condition of items before washing. See Washing Procedures for preparing, loading and adding chlorine bleach.
Lint	<ul style="list-style-type: none"> • Incorrect sorting. • Tissues left in pocket. • Overloading the washer. • Not enough detergent. • Undissolved detergent has left a residue resembling lint. • Static cling is attracting lint. • Load washed too long. 	<ul style="list-style-type: none"> • Reduce load size. Rewash using correct water temperature, water level, and amount of detergent. • Add nonprecipitating water conditioner to wash water to remove detergent residue. • Add liquid fabric softener to final rinse. • Dry load in dryer. • Remove lint with lint brush or roller. 	<ul style="list-style-type: none"> • See Washing Procedures for sorting and preparing the wash load. • Do not overload washer. • Use correct temperature and amount of detergent, water and wash time.
Pilling (Fibers break off, ball up and cling to fabric.)	<ul style="list-style-type: none"> • Pilling is normal with synthetic and permanent press fabrics. This is due to abrasion from normal wear. 	<ul style="list-style-type: none"> • Use a lint brush or shaver to remove pills. 	<ul style="list-style-type: none"> • Use fabric softener in the washer to lubricate fibers. • When ironing, use spray starch or fabric finish on collars/cuffs. • Turn items inside out to reduce abrasion.
Residue or powder on dark items; stiff, harsh fabrics.	<ul style="list-style-type: none"> • Undissolved detergent. • Some nonphosphate granular detergents can combine with hard water minerals to form a residue. • Overloading the washer. 	<ul style="list-style-type: none"> • Rewash load. 	<ul style="list-style-type: none"> • Increase water temperature using hottest water safe for fabric. • Do not overload washer. • Use liquid detergent or use nonprecipitating water conditioner with nonphosphate granular detergent.
Wrinkling	<ul style="list-style-type: none"> • Overloading the washer. • Incorrect wash cycle for wash load. 	<ul style="list-style-type: none"> • Reduce load size. • Rinse in cold water with liquid fabric softener using the Perm Press or Delicate cycle. 	<ul style="list-style-type: none"> • Do not overload washer. • Remove items from washer as soon as cycle is completed. • Use liquid fabric softener.
Yellow buildup of body soil on synthetic fabrics	<ul style="list-style-type: none"> • Agitation time too short. • Wash water temperature too low. • Not enough detergent. 	<ul style="list-style-type: none"> • Soak in detergent booster or product containing enzymes. • Wash in hot water (120°F/49°C) using full permanent press cycle. Increase detergent. Add bleach or treat with color remover. 	<ul style="list-style-type: none"> • Select correct wash cycle. • Use correct amount of detergent. • Wash synthetics frequently using hot or warm water.
Yellow or brown rust stains	<ul style="list-style-type: none"> • Iron or manganese in water supply, water pipes, or water heater. 	<ul style="list-style-type: none"> • To restore discolored load of whites, use rust remover safe for fabric. • Do not use chlorine bleach to remove rust stains. It may intensify discoloration. 	<ul style="list-style-type: none"> • Use nonprecipitating water softener. • Before washing, run hot water for a few minutes to clear lines. • Drain water heater occasional • For an ongoing problem, install an iron filter in your water supply system.

Care and Cleaning

Outside

- When washing is completed, wipe top and sides of washer with a damp cloth. Turn water faucets off to prevent pressure build-up in the hoses.
- As needed, clean the cabinet with mild soap and water. **Never use harsh, gritty or abrasive cleansers.** If door or console becomes stained, clean with diluted chlorine bleach [1/2 cup (120 ml) in 1 quart (.95 L) water]. Rinse several times with clear water.
- Remove glue residue from tape or labels with a mixture of warm water and mild detergent. Or, touch residue with the sticky side of the tape or label.
- **Before moving the washer,** place a strip of cardboard or thin fiberboard under the front leveling legs to prevent floor damage.

Cleaning the Dispenser Drawer Area

Detergent and fabric softener may build up in the dispenser drawer. Residue should be removed once or twice a month.

- Remove the drawer by first sliding the safety latch to the right, then pulling the drawer out until it stops.

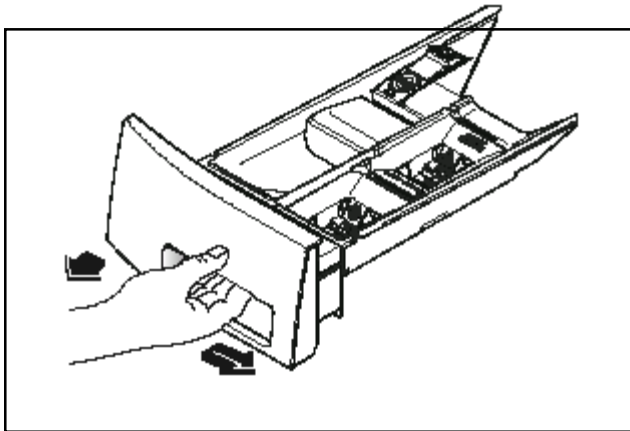

- Reach back into the left rear corner of the drawer cavity and press down firmly on the lock tab (left rear portion of the drawer). Pull out the drawer.

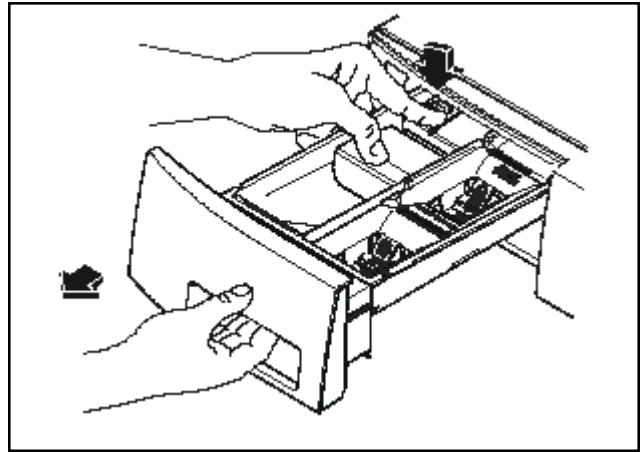

- Remove the insert from the bleach and fabric softener compartments.

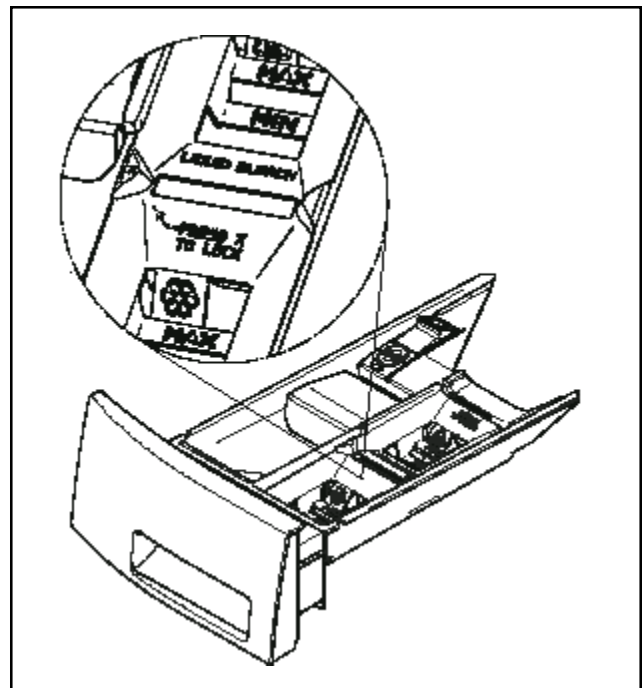

- Rinse the drawer and inserts with hot tap water to remove traces of accumulated powders and liquids. Large amounts of fabric softener residue may indicate improper dilution or more frequent cleaning is required.

- To clean the drawer opening, use a small brush to clean the recess. Remove all residue from the upper and lower parts of the recess.

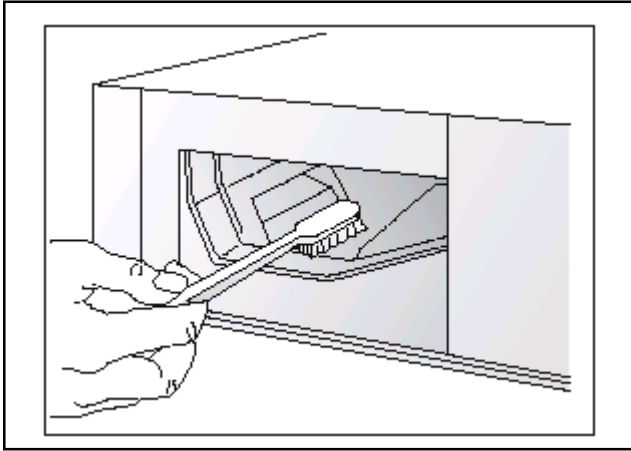

- Replace the insert pressing the "X" to lock it in place. Return the dispenser drawer.

Winterizing Instructions

If the washer is stored in an area where freezing can occur or moved in freezing temperatures, follow these winterizing instructions to prevent damage to the washer:



1. Turn off water supply faucets.
2. Disconnect hoses from water supply and drain water from hoses.

3. Plug electrical cord into a properly grounded electrical outlet.
4. Add 1 gallon (3.8 L) nontoxic recreational vehicle (RV) antifreeze to empty wash drum. Close door.
5. Select the Drain/Spin cycle. Press START and let the washer drain for 1 minute to drain out all the water. Not all of the RV antifreeze will be expelled.
6. Press Pause Cancel twice, unplug electrical power cord, dry off drum interior and close door.
7. Remove dispenser drawer. Drain any water in compartments and dry compartments. Replace drawer.
8. Store washer in an upright position.
9. To remove antifreeze from washer after storage, run empty washer through a complete cycle using detergent. **Do not add wash load.**

Avoid Service Checklist

Before calling for service, review this list. It may save both time and expense. The list includes common concerns that are not the result of defective workmanship or materials in this washer.

OCCURRENCE NOISE

POSSIBLE CAUSE / SOLUTION

High pitch "jet engine" noise.

- A certain amount of motor whine is normal during the spin cycle.

Rattling and clanking noise.

- Foreign objects such as coins or safety pins may be in drum or pump. Stop washer and check drum. If noise continues after washer is restarted, objects may be in pump. Call your authorized servicer.
- Belt buckles and metal fasteners are hitting wash drum. To prevent unnecessary noise and damage to drum, fasten fasteners and turn items inside out.

Squealing sound or hot rubber odor.

- Washer is overloaded. Do not overload washer. Stop washer and reduce load.

Thumping sound.

- Heavy wash loads may produce a thumping sound. This is usually normal. If sound continues, washer is probably out of balance. Stop washer and redistribute wash load.

Vibrating noise.

- Washer is not resting firmly on floor. Move washer so it rests firmly on floor. Adjust leveling legs. NOTE: Some shaking of the washer is normal without moving across the floor. See INSTALLATION INSTRUCTIONS for details.
- Shipping bolts and foam blocks have not been removed during installation. See INSTALLATION INSTRUCTIONS for removing shipping bolts and foam blocks.
- Wash load unevenly distributed in drum. Stop washer and rearrange wash load.

**OPERATING
Washer does not start.**

- Electrical power cord may not be plugged in or connection may be loose. Make sure plug fits tightly in wall outlet.
- House fuse blown, circuit breaker tripped, or a power outage has occurred. Reset circuit breaker or replace fuse. Do not increase fuse capacity. If problem is a circuit overload, have it corrected by a qualified electrician. If problem is a power outage, call local electric company.
- Water supply faucets are not turned on. Turn on water supply faucets.
- Motor is overheated. Washer motor will stop if it becomes over heated. It will automatically restart after a cool down period of up to 30 minutes (if washer has not been manually turned off).

Washer won't spin.

- Dispenser drawer is not completely closed. Close dispenser drawer.
- Washer door is not completely closed. Close door completely.
- Dispenser drawer is not completely closed. Close dispenser drawer.
- Load is too small. Add 1 or 2 similar items to help balance the load.

OCCURRENCE

POSSIBLE CAUSE / SOLUTION

Residue left in drum.

- Heavily soiled items. Wipe drum with a nonabrasive household cleanser, then rinse. Shake or brush excess dirt and sand from items before washing.

WATER

Water collects in bleach and fabric softener compartments.

- This is a result of the siphoning action and is part of the normal operation of the washer. Water may be removed by removing the dispenser drawer and draining water into the empty drum or sink.

Wash load too wet after spin.

- Washer is overloaded. Do not overload washer. See Washing Procedures.
- Load is too small. Add 1 or 2 similar items to help balance the load.
- Load is out of balance. Rearrange load to allow proper spinning.
- Drain hose is kinked. Straighten drain hose.

Water does not enter washer or it enters slowly.

- Water supply is not adequate in area. Check another faucet in the house. Wait until water supply and pressure increase.
- Water supply faucets are not completely open. Fully open hot and cold faucets.
- Water is being used elsewhere in the house. Water pressure must be at least 30 psi (260 kPa). Avoid running water elsewhere while washer is filling.
- Water inlet hoses are kinked. Straighten hoses.
- Water inlet screens are plugged. Clean screens.

Warm or hot water is not hot enough.

- Hot water heater is set too low or is a distance from washer. Measure hot water temperature at nearby faucet with candy or meat thermometer. Water temperature should be at least 120°F (49°C). Adjust water heater as necessary.
- Hot water is being used elsewhere in the house. Avoid using hot water elsewhere before or during washer use. There may not be enough hot water available for proper cleaning. If problem persists, your hot water system may be unable to support more than 1 use at a time.

Water in washer does not drain or drains slowly.

- Drain hose is kinked or clogged. Clean and straighten the drain hose.
- Maximum standpipe height is 8' (2.4 m).

Water leaks.

- Fill hose connection is loose at faucet or washer. Check and tighten hose connections. Install rubber sealing washers provided.
- House drain pipes are clogged. Unclog drain pipes. Contact plumber if necessary.

Oversudsing.

- Wrong detergent. Run rinse cycle. Use a low-sudsing, high efficiency detergent.
- Too much detergent. Run rinse cycle. Use less detergent in future loads

OCCURRENCE

POSSIBLE CAUSE / SOLUTION

Incorrect wash and rinse temperatures.

- Hot and cold water hoses are connected to wrong supply faucets. Connect hot water hose to hot water faucet and cold water hose to cold water faucet.
-

Water is entering washer but tub does not fill.

- Drain hose standpipe is incorrect height. Standpipe must be a minimum of 23.6" (60 cm) high to prevent siphoning. See INSTALLATION INSTRUCTIONS.

FRIGIDAIRE

Tumble Action Washer Warranty

Sample warranty - always check warranty with product

Keep your sales receipt!

WARRANTY LENGTH:	FRIGIDAIRE WILL PAY FOR:
FULL ONE-YEAR WARRANTY From Date of Purchase	Labor and replacement parts which prove to be defective in materials or workmanship. <i>Any warranty service must be provided by Frigidaire or an authorized Frigidaire service company.</i>
LIMITED 2nd-5th YEAR WARRANTY From Date of Purchase	Replacement part for the motor, driven pulley or motor controller which prove to be defective.
LIMITED 2nd-25th YEAR WARRANTY From Date of Purchase	Replacement part for an inner wash basket that breaks due to a defect in materials or workmanship. (Excludes Alaska)

FRIGIDAIRE WILL NOT PAY FOR:

- Service calls where the problem is not the fault of the washer. Below are some, but not every example of issues where **you must pay the service call cost.**

Service calls to:

 - remove shipping devices or to level your washer
 - correct leaks at water inlet hose connections
 - correct improper placement of drain hose in your drain
 - advise you on proper setting of controls or to instruct you how to use the washer

Service calls where the problem is due to:

 - house wiring faults, improper electrical voltage, blown house fuse, tripped circuit breaker
 - slow or backed-up drain, weak (spongy) floor, insects or rodents causing the problem
 - frozen water lines in the washer or house
 - washer installed outside, exposed to the elements
- Repairs for washer used in a commercial application or more than single-family household use.
- Repairs for delivery damage to your washer or damage caused by misuse, fire, flood, acts of God, or use of parts or servicers not authorized by Frigidaire.
- Any labor costs during the limited warranties.
- Travel costs of servicer to your home in the state of Alaska.
- Pickup, delivery or installation of your washer.
- Repairs on products with serial plates that have been altered, removed, or cannot be read.
- Consequential or incidental damages such as property damage and incidental expenses resulting from any breach of this written or any implied warranty. *Some states do not allow the exclusion or limitation of incidental or consequential damages, so this limitation or exclusion may not apply to you.*

Keep your sales receipt. The date on the receipt establishes the warranty period should service be required. This written warranty gives you specific rights. You may also have other rights which vary from state to state. If you need service, first read "Avoid Service Checklist" section of this booklet. If service is still needed, contact Frigidaire Home Products Consumer Service or an authorized Frigidaire servicer. For information on where to obtain service, contact our Consumer Assistance Center at 1-800-944-9044.

Product features or specifications as described or illustrated are subject to change without notice. This warranty made by White Consolidated Industries, Inc. applies only in the 50 states of the U.S.A. and Puerto Rico.



WARRANTY (CANADA) FRIGIDAIRE TUMBLE ACTION WASHERS

WARRANTOR:

ELECTROLUX HOME PRODUCTS CANADA
6150 McLaughlin Road, Unit#1
Mississauga, Ontario
L5R 4C2

**Sample warranty - always check
warranty with product**

For service under this warranty, contact your local dealer/retailer, authorized ELECTROLUX HOME PRODUCTS PARTS AND SERVICE depot, or:

ELECTROLUX HOME PRODUCTS CANADA
6150 McLaughlin Road, Unit#1
Mississauga, Ontario
L5R 4C2
Tel.: (905) 568-3433
Fax: (905) 568-3542

WARRANTY PERIOD:

For the first year after purchase by the original consumer/owner:

For the second through fifth year after purchase by the original consumer/owner:

For the second through twenty-fifth year after purchase by the original consumer/owner:

WARRANTOR WILL THROUGH ITS AUTHORIZED SERVICE DEPOT:

Pay all costs to repair or replace any defective parts.

Pay all costs (excluding labour to install) to replace any defective motor, driven pulley, or motor controller.

Pay all costs (excluding labour to install) of an inner wash basket.

WARRANTY APPLIES TO:

- Products purchased and installed in Canada for personal single family household use.
- Defects resulting or arising out of the manufacturing process.
- Products bearing legible manufacturer's model and serial numbers.
- Replacement parts only for the remainder of the original warranty.

WARRANTY DOES NOT APPLY TO:

- Transportation damage.
- Supply and replacement of porcelain, fuses, glass and light bulbs.
- Parts and service supplied or obtained from other than ELECTROLUX HOME PRODUCTS PARTS AND SERVICE or ELECTROLUX HOME PRODUCTS PARTS AND SERVICE authorized depots.
- Damage or failure as the result of abuse, improper or commercial use.

CONSUMER/OWNER RESPONSIBILITY:

- To provide proof of the original date of purchase by means of a bill of sale or payment record verifying purchase date.
- To pay all costs to make the appliance readily accessible for service.
- To ensure proper power supply and connection of the appliance to same.
- Proper installation, control setting and care of finish.

This warranty is in addition to any statutory warranties contained in any applicable legislation. The terms and conditions of this warranty are not intended to exclude or limit your rights under those statutes. The warrantor however reserves the right to charge transportation and travelling costs for distances in excess of 48 kilometres (30 miles) from the nearest ELECTROLUX HOME PRODUCTS PARTS AND SERVICE authorized service depot.

This warranty plus the statutory warranties mentioned are the only warranties given to the consumer/owner for this product.

SECTION E - OPERATION

Control

The control is mounted to the back of the console. The control:

1. Provides power to the dispenser solenoids, wax motor, door lock solenoid, drain pump and speed control board.
2. Sends signals to the speed control board to tell it what program to run.
4. Checks the status of the reed switch, door switch and the sensor.



Dispenser Drawer Reed Switch

The dispenser drawer reed switch is a safety switch that prevents the washer from operating in the wash or rinse cycles with the dispenser drawer open. The switch is located behind the control panel next to the dispenser drawer. The electronic control board sends a signal through the reed switch circuit. When the signal is interrupted by the contacts of the reed switch being open, the board prevents the washer from operating.



The reed switch contacts are controlled by the magnetic field of the magnet located in the front panel of the dispenser drawer.

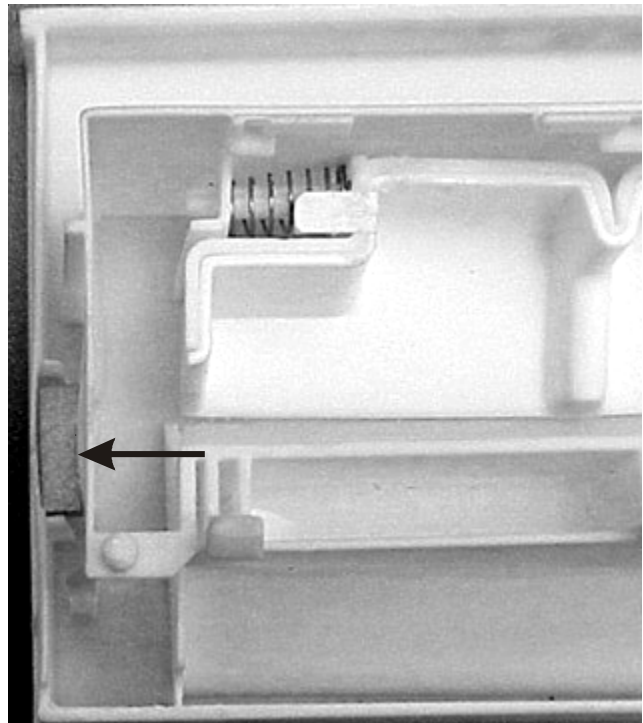

When the drawer is closed, the magnet causes the contacts of the reed switch to close, completing a circuit in the control board.

Door Switch Assembly

The door switch assembly, located behind the front panel, is a safety feature that prevents the washer from operating when the door is open and locks the door in the spin cycle.

The door lock assembly is made up of a coil, door switch, switch actuator, locking fork, wax motor, auxiliary switch and spin lock arm.

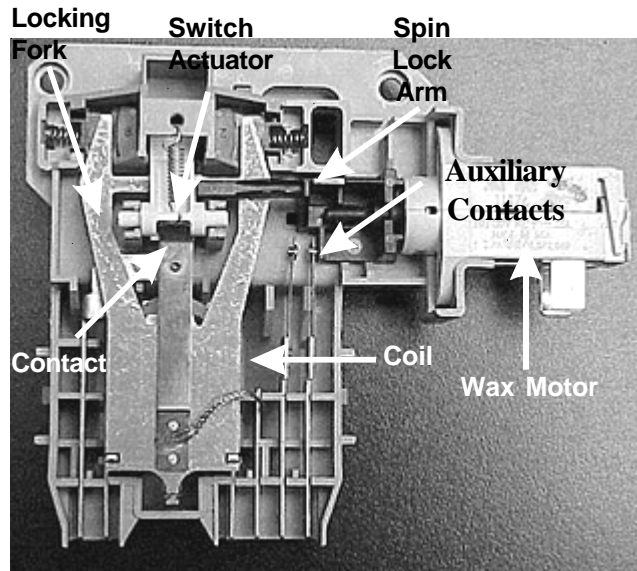

When a cycle is selected and the start pad is touched, the control board applies power to the coil. The magnet field of the coil pulls the locking fork down and tries to pull the contacts of the door lock switch closed. If the washer door is open, a tab on the switch actuator prevents the contacts from closing and the locking fork will not allow the door to be closed until the stop pad is touched, removing current from the coil. When the washer door is closed, the door strike pivots the switch actuator out of the way allowing the magnetic field of the coil to close the contacts of the door lock switch and the locking fork locks the door. The wax motor and spin lock arm are used to prevent the door from being opened while the spin basket is still spinning. Power is applied to the wax motor when the washer is in spin. When power is applied to the wax motor, it expands its piston within 30 to 40 seconds driving the spin lock arm between the locking fork and the switch actuator holding the locking fork down. At the same time, the piston closes the door lock auxiliary switch allowing the washer to go into spin. When power is removed from the wax motor, it takes about 90 seconds for the wax motor to cool down and retract the piston, pulling the spin lock arm back away from the locking fork and auxiliary switch. This provides enough time for the spin basket to slow its rotation down to the wash speed before the door could possibly be opened.

Pressure Switch (Good Models)

The pressure switch, mounted to the right side panel under the top of the washer, controls the water level in the washer.



The pressure switch is made up of a single pole double throw switch, but only contacts 1 and 2 are used. The contacts are controlled by a bellows inside a sealed chamber. The chamber is connect by a hose to the air bell located at the bottom of the washer attached to the drain boot. L 1 is applied to the pressure switch, by the control. If the water level is below 1/2 inch from the bottom of the spin basket, contacts 1 to 2 of the pressure switch close applying power to one side of the (3) solenoids of the water valve assembly. The other side of the solenoids are connected to neutral by a relay contact on the control board. When the cycle calls for water, depending on the water temperature selected and the increment of the cycle, the control board connects one or two of three solenoid coils to neutral activating the water valve solenoids. When the correct water level is reached, contacts 1 and 2 open, signaling the control to remove neutral from the solenoids.

Electronic Water Level Sensor (Better Models)

The electronic water level sensor, mounted to the right side panel under the top of the washer, controls the water level in the washer.

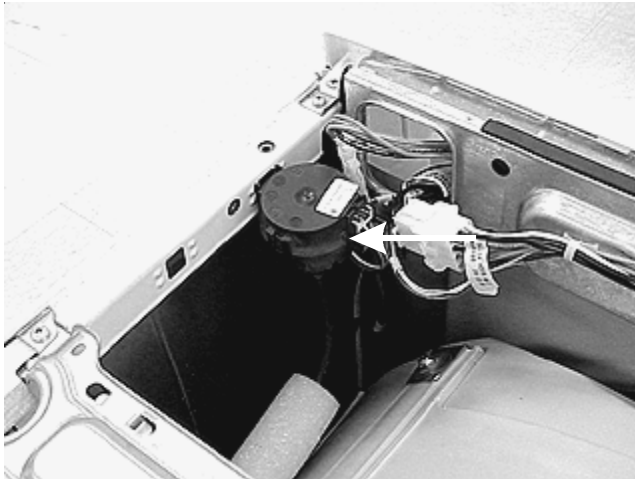

The electronic water level sensor is made up of an electronic board and a bellow inside a sealed chamber. The chamber is connected by a hose to the air bell attached to the drain boot located at the bottom of the washer. The electronic board reads the pressure in the bellow and converts it to an electronic signal. This signal is sent to the control board. The control board controls the incoming water by connecting or disconnecting neutral to the water solenoids.

Water Inlet Valve Assembly

The water inlet valve assembly is made up of a plastic housing, 2 tubes (that the inlet water hoses are connected to), 3 solenoids and an automatic temperature control (on better models only).

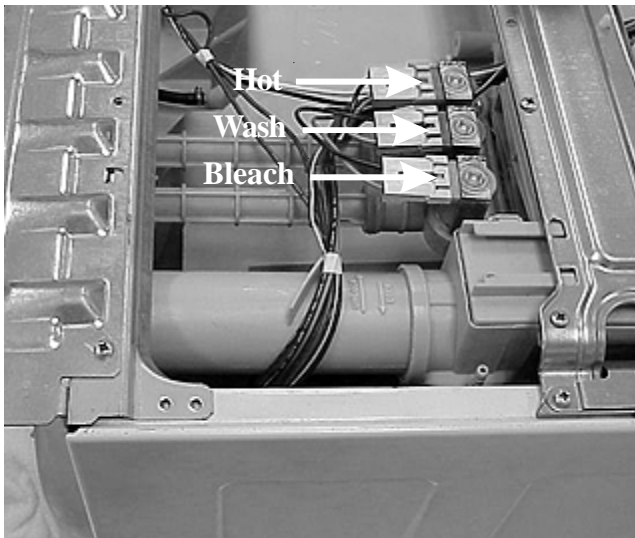

The hot solenoid is connected to the incoming hot water. The wash and bleach solenoids share a common input cavity that is connected to the cold water supply.

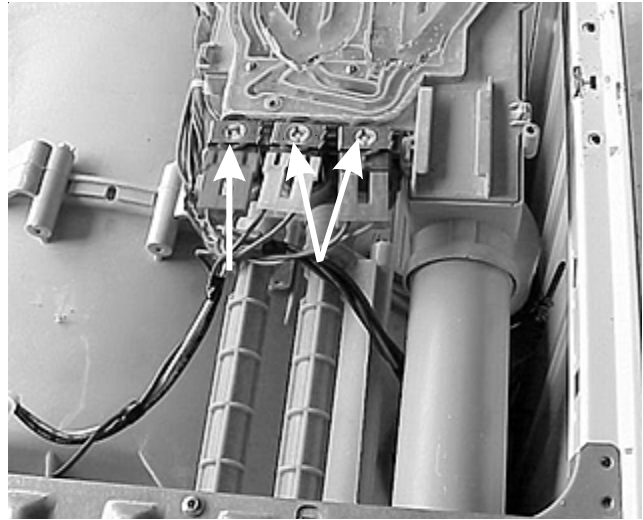

The hot and wash solenoids share a common output cavity, with the bleach solenoid having a separate output cavity.

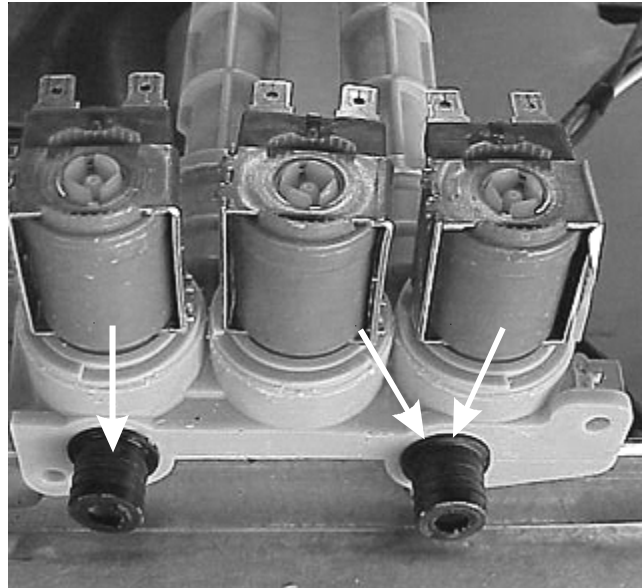

Valve Operation

The (3) inlet solenoid valves are identical in construction and operation. The valve body provides an air passage with a large orifice and seat where the water can be stopped. The outlet of the valve body empties into a chamber. A moveable rubber diaphragm operates against the valve seat to start and stop the flow of water. The diaphragm is operated by water pressure. It has a small bleed orifice outside the seat contact area and a large main orifice at its center. The armature of the solenoid serves to open and close the main orifice. The

armature operates within a closed metal tube (valve guide) which is sealed by the outer edge of the diaphragm to the valve body. A coil spring holds the armature down against the diaphragm main orifice when the solenoid is not energized.

The following line drawings and text explains basic valve operation.

When the valve is in a closed position, the solenoid is not energized. Water has bled through the diaphragm bleed orifice placing incoming line pressure on top of the diaphragm. The bottom of the diaphragm is essentially at atmospheric pressure (open to the outlet) and the pressure differential holds the valve shut.

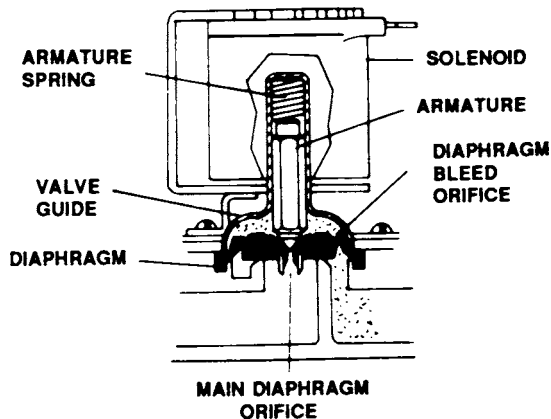

Water Valve Closed

When the solenoid is energized, the resulting magnetic field pulls the armature up into the valve guide. The armature spring is compressed by this action. When the armature moves up, it allows the water on the top of the diaphragm to drain through the main orifice.

The diaphragm bleed orifice is much smaller than the main orifice and will not admit enough water to maintain pressure on the top side of the diaphragm. Thus, as the pressure on the top of the diaphragm is reduced to almost zero, the pressure on the bottom lifts the diaphragm off the valve seat, allowing a full flow of water.

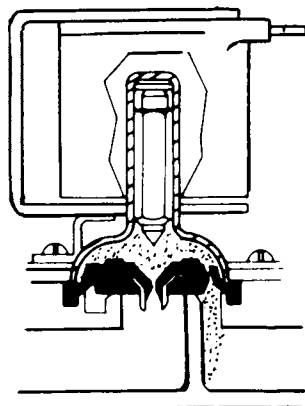

Solenoid Activated

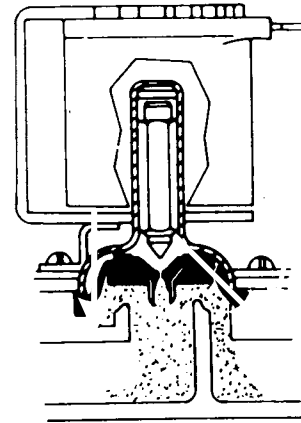

Water Valve Open and Diaphragm Up

When the solenoid is de-energized, the armature drops down, closing the diaphragm main orifice. Water continues to flow through the diaphragm bleed orifice, equalizing the pressure and allowing the spring to push the diaphragm down against the valve seat.

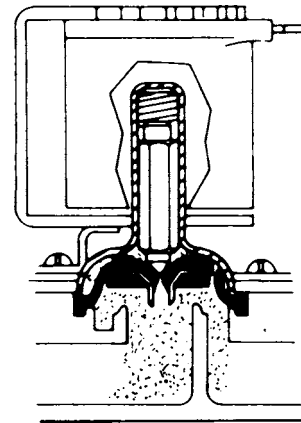

Water Valve Closing

Water Temperature (Good Models)

When the **TEMP** switch is set to **Hot/Cold**, in the wash cycle the hot solenoid is activated and the Bleach solenoid is activated, for all except the last fill, in rinse. For the last rinse fill, the wash and bleach solenoids are activated. When the **TEMP** switch is set to **Warm/Cold**, in the wash cycle, the hot and wash solenoids are activated and the Bleach solenoid is activated, for all except the last fill, in rinse. For the last rinse fill, the wash and bleach solenoids are activated. When the **TEMP** switch is set to **Warm/Warm**, in the wash cycle the hot and wash solenoids are activated and the Bleach solenoid is activated, for all except the last fill, in rinse. For the last rinse fill, the hot and bleach solenoids are activated.

When the **TEMP** switch is set to **Cold/Cold**, in the wash cycle the wash solenoid is activated and the bleach solenoid is activated, for all except the last fill, in rinse. For the last rinse fill, the wash and bleach solenoids are activated.

Auto Temp System: (Better Models)

The auto temp system controls the minimum temperature of the cold water setting (approximately 65° F) and maximum temperature of the warm and hot water setting (approximately 90° F and 130° F). Auto temp system is made up of the control board and a negative temperature coefficient sensor mounted in the water inlet valve assembly.

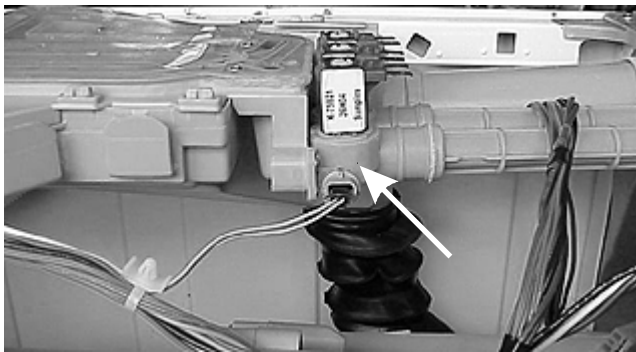

When warm or hot temperature is selected in the wash cycle, the control board connects the hot water solenoid to neutral and cycles the center cold water solenoid off and on to regulated the temperature. When cold temperature is selected, the control board connects the center cold water solenoid to neutral and cycles the hot water solenoid off and on to regulated the temperature. When a Warm rinse is selected for the final rinse, the control connect the outside cold solenoid to neutral and cycles the hot solenoid.

Automatic Dispenser:

The automatic dispenser for detergent, liquid bleach and fabric softener system is made up of the dispenser cavity



and a removable drawer with three cavities, one for detergent, one for bleach and one for fabric softener.

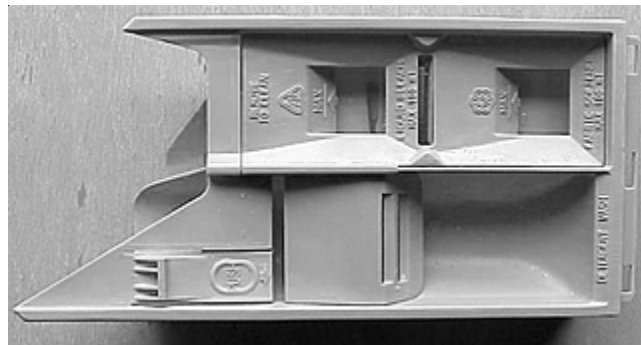

A plastic conveyer is snapped to the bottom of the drawer to direct the outputs, from the bleach and softener chambers, to the dispenser housing outlet channel. This prevents the mixtures from coming out the front of the drawer.

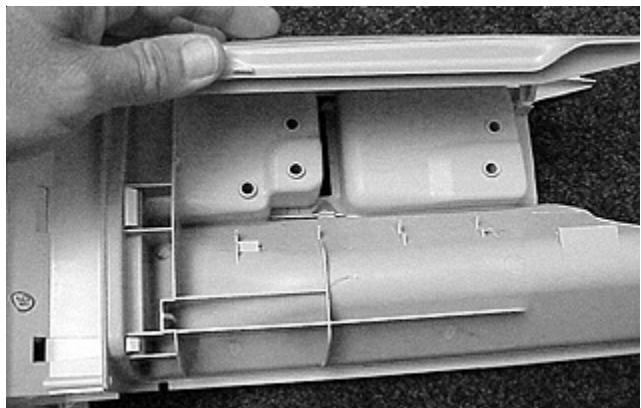

The 2 outlets of the water inlet valve assembly are inserted into the rear of the automatic dispenser. During the fill cycles water is directed into the top of the cavity through 2 inlets. The inlet on the right, as view from the front of the washer, is connected to the combination output of the hot water solenoid and the center cold water solenoid.

The inlet on the left, as view from the front of the washer, is connected left-hand cold water solenoid.

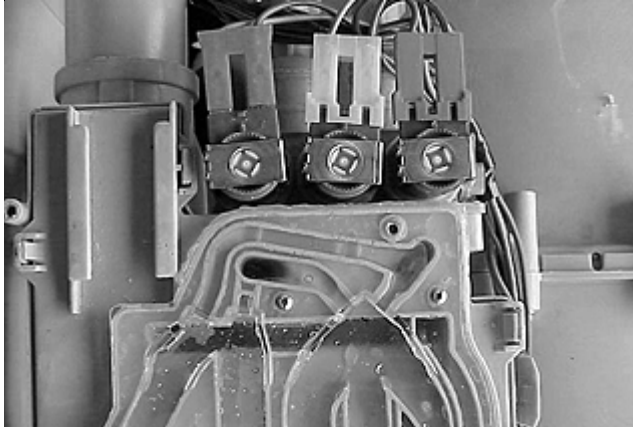

In the fill cycles, water enters into the top of cavity and is directed across the top of the cavity by 4 channels: the dispenser bypass channel, the detergent channel, bleach channel and the fabric softener channel. The channel that receives the water is determined by which inlet supplies the water or if both inlets supply the water.

The dispenser advanced rinsing technology channel receives water whenever the inlet on the right, as viewed from the front of the washer, is activated.

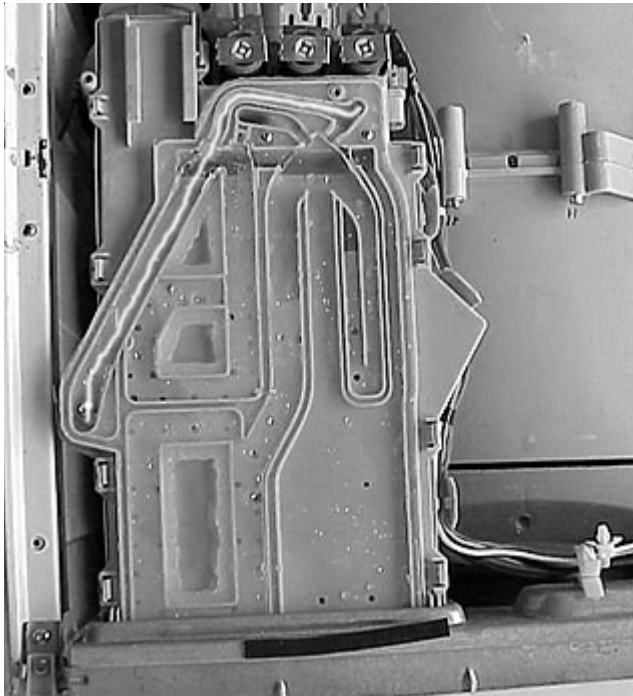

This path allows the water to bypass the dispenser drawer and enter the tub by an advanced rinsing technology hose connected between the cavity and the bellows.



The detergent dispenser channel receives water from the right-hand input, as viewed from the front of the washer. The detergent channel forms a loop, that allows the water to pass over the detergent section of the drawer.

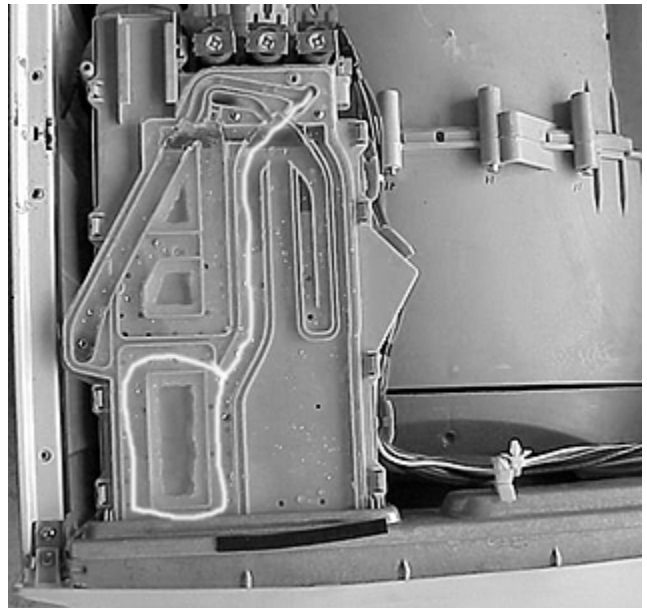

As the water pass over the detergent section, holes in the cavity allows some of the water to enter and flush the detergent cavity.



Water in this channel and the mixture from the detergent drawer flow into the tub through the large hose at the rear of the dispenser.



Since the flow of the incoming water is more than the holes can dispense, the excess water backs up into a channel across the rear of the dispenser.

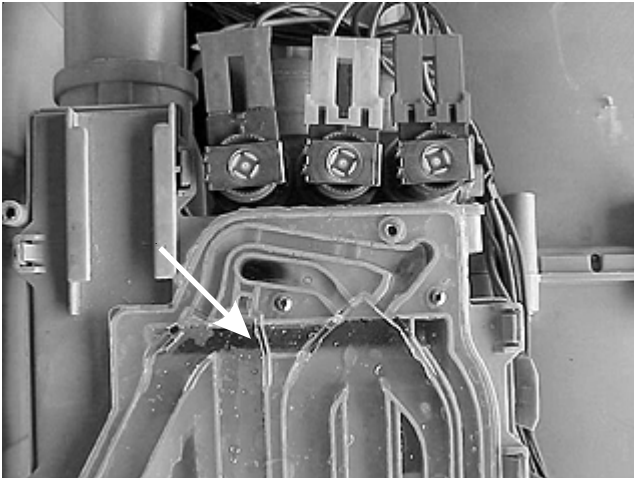

Detergent is dispensed at the start of the cycle, but bleach and fabric softener are not dispensed until later in the cycle. To allow all three items to be added to the washer before the start of the cycle, the bleach and softener cavities in the drawer have tubes molded into the bottom of them.

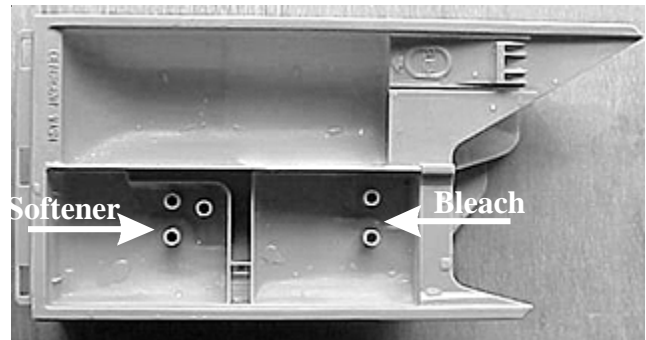

These tubes allow bleach or softener to be added to their cavity without being dispensed as long as the liquid is below the top of the tubes. At the proper time in the cycle when bleach or fabric softener is to be dispensed, water is added to the cavity. This raises the mixture above the top of the tube and the bleach or fabric softener starts flow into the tub.

To allow the cavities to empty, the cover of the detergent drawer cover has tubes molded into it that fit over the tubes in the cavities.

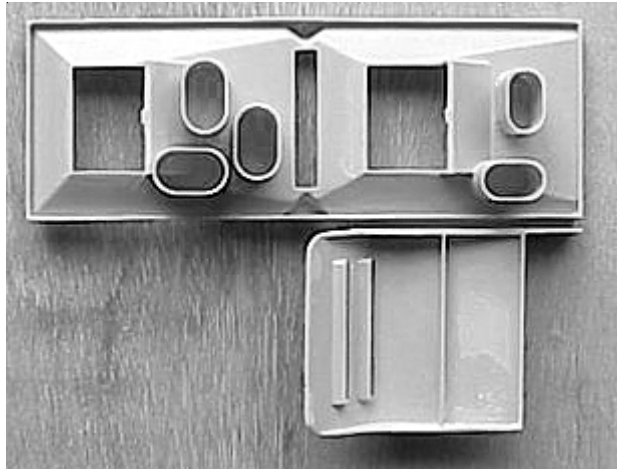

These tubes are larger than the tubes in the cavity and are designed to fit over the tubes, but not touch the bottom of the cavity when the cover is installed. When water is added to either the bleach or fabric softener liquid, the mixture level rises above the tubes in the cavity and flows into the washer tub. Since the end of the tube on the insert does not touch the bottom of the cavity, a siphoning action will start when the solenoid activates and allows water into the cavity. The added water creates an "overflow" condition and starts the siphoning. The cavity will empty itself when the water is turned off by the solenoid.

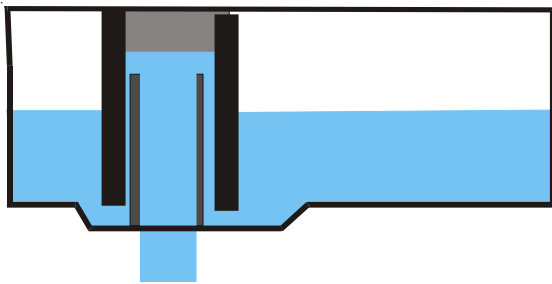

The bleach dispenser channel receives water from the left-hand input, as viewed from the front of the washer. The bleach channel forms a path that allows the water to pass over the bleach section of the cavity

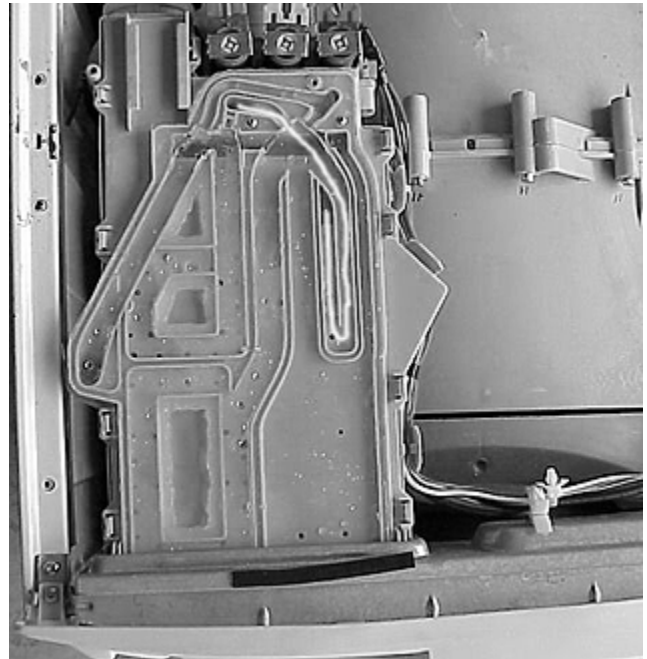

As the water pass over the bleach section, holes in the cavity allows some of the water to enter and mix with the bleach.

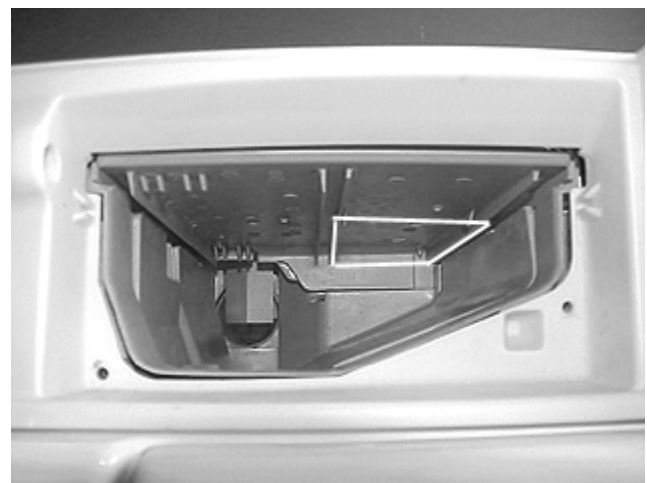

This raises the mixture level above the tubes in the drawer bleach cavity allowing the mixture to flow into the tub.

Like the detergent channel, the flow of the incoming water is more than the holes can dispense. The excess water backs up into the channel across the rear of the dispenser and flows into the tub.

For water to enter the fabric softener channel, both the left and right inlets must be activated. As the water from the left inlet passes over the channel, it collides with the water from the right inlet.

This collision changes the water path directing it to the front of the cavity and into the fabric softener channel. The fabric softener channel forms a loop, that allows the water to pass over the fabric softener cavity section of the drawer.

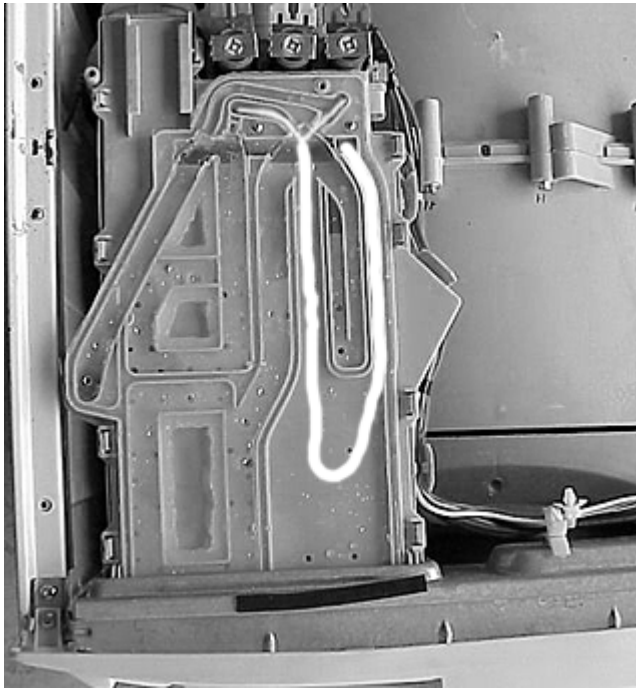

As the water passes over the fabric softener section, holes in the cavity allows some of the water to enter and mix with the fabric softener.



This raises the mixture level above the tubes in the drawer fabric softener cavity allowing the mixture to flow into the tub. Like the detergent channel, the flow of the incoming water is more than the holes can dispense. The excess water backs up into the channel across the rear of the dispenser and flows into the tub.

Drain Pump:

The drain pump is mounted to the bottom plate of the washer behind the access panel. It operates on 120 VAC and is controlled by the control board and pressure switch. The pump out specifications of the drain pump vary from 13 G.P.M with a 2 foot standpipe height to 8 G.P.M. with a 8 foot standpipe height.

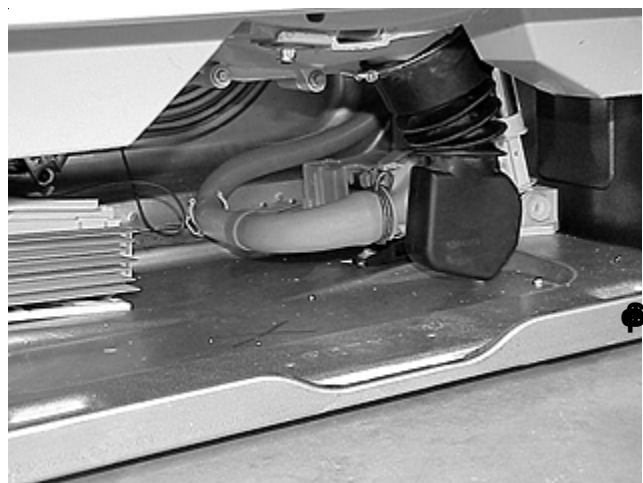

Speed Control:

The speed control board is mounted to the bottom plate of the washer in the left rear corner of the washer. The speed control board controls the following operations:

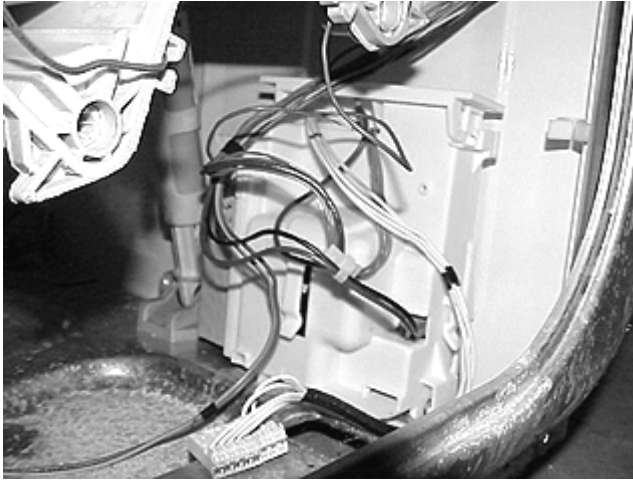

Note: The control board is mounted in the console. The speed control board is mounted in the left rear corner of the washer.

1. The speed of the drive motor by converting input line to neutral single phase 60 Hertz voltage, to a varying frequency, three phase output voltage from zero to 300 VAC. By varying the amount, frequency, and polarity of the voltage and comparing the input from the tachogenerator on the drive motor, the speed control board can operate the drive motor at a preprogrammed speed and direction.
2. The balance of the load in the washer during the spin cycle by converting the sine wave from the tachogenerator to square waves and comparing the distance between the square waves.

Motor:

The motor is mounted to the bottom of the outer tub.



The motor is an induction, three phase AC motor that varies speeds when the voltage from the speed control board varies in frequency and amount. The motor has a tachogenerator that inputs the speed of the motor to the speed control board.

SECTION E - CONSTRUCTION

The front loading, tumble action clothes washer consists of a perforated, cylindrical spin basket suspended horizontally on its axis within a larger solid cylindrical tub. This assembly is suspended by springs within a four piece steel cabinet. A see through door and a flexible bellows (seal) provides access for loading and unloading clothes.

Cabinet

The cabinet is made of heavy steel in a four piece design. The sides and rear are Tog-I-locked at the rear corners and base. The rear of the cabinet is galvanized steel with an access panel.

Front Panel and Door Assembly

The front panels is attached with screws to the side panels and bottom.

Bellows

The bellows is a rubber sleeve that seals the suspended outer tub to the stationary cabinet front at the tub opening. Its purpose is to provide a water tight opening into the tub that can be sealed by the cabinet door, yet allow flexibility for the oscillation of the tub during the wash and spin cycles.

Outer Tub Assembly

The outer tub assembly is supported by two suspension springs and stabilized by two air shock assemblies. A cement counter weight is mounted to the front of the outer tub by screws. A counterweight is molded into the rear half of the outer tub. These counterweights prevent excessive oscillation of the entire suspended assembly during an unbalanced spin cycle.

Spin Basket Assembly

The spin basket is constructed of stainless steel. The circumference of the basket is perforated to allow water to flow through it as it revolves. A heavy steel shaft is pressed into the spin basket support which is then bolted to the basket. The spin basket assembly is entirely supported by two ball bearings pressed into the rear of the outer tub.

A large drive pulley is mounted to the free end of the shaft that extends through the rear of the outer tub.

There are three plastic vanes mounted to the spin basket to aid in the washing action during the wash cycle. The rotation of the spin basket provides both the washing action during the wash cycle, and water extraction during the spin cycle.

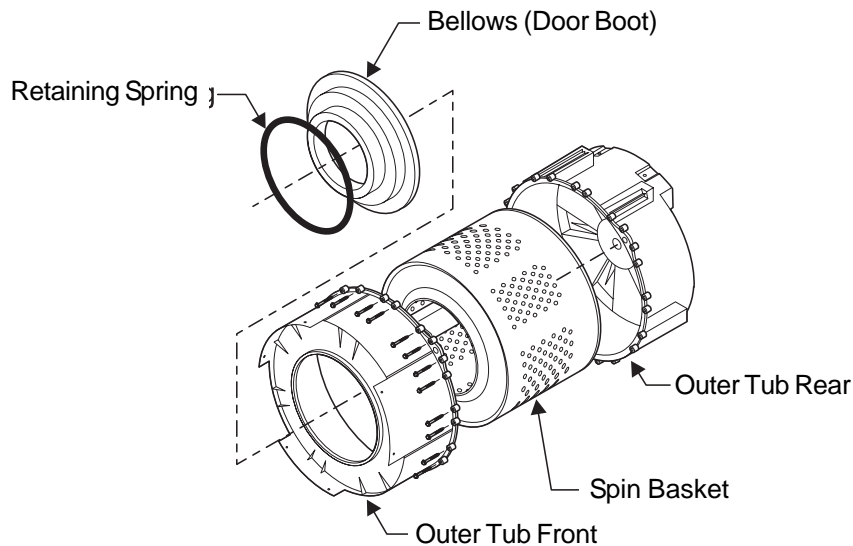

SECTION F - TROUBLESHOOTING

The electronic controls of the 3.0 Cu. Ft. horizontal axis washers have self diagnostics codes built in that cover most products failures.

Model differences:

- Better models have a digital readout display
- Good models do not have a digital readout display

In the **Better Models** line, the failure codes will appear in the display as an E followed by two numbers, a number and a letter or two letters. The control will beep and the **Door Lock, Wash, Rinse, Final Spin and Control** indicator lights will flash. Example: **E14**. To stop the flashing and beeping, the customer may touch the **Pause Cancel** button. The error code remains stored in the control but once the problem is corrected, it does not effect the operation of the washer. If the failure is something that the customer can correct (such as the water faucets being turned off), the washer will operate normally the next time it is started.

In the **Good Models** line, the control signals the failure code by flashing the five indicator lights of **Door Lock, Wash, Rinse, Final Spin and Control** for the first number or letter after the E and the **START** indicator light for the second number or letter after the E. When a failure occurs, the washer stops or pauses and the control beeps and flashes the five indicator lights to tell the customer that a failure has occurred. To stop the flashing and beeping, the customer may touch the **Pause Cancel** button. The error code remains stored in the control but once the problem is corrected, it does not effect the operation of the washer. If the failure is something that the customer can correct (such as the water faucets being turned off), the washer will operate normally the next time it is started.

To recall an error code,

- Wake the machine by pressing any button
- Wait 5 seconds
- Press and hold the **START** and **Pause Cancel** buttons simultaneously
- All LEDs will go blank and after a few seconds the control will signal the stored code using audible

beeps and blinking LEDs. The control will repeatedly signal the code, as long as the **START and Pause Cancel** buttons are pressed

A two-second pause between repeats affords you the ability to make accurate counts to identify the correct error codes.

Please Note the following..... on a small number of washers with serial number prefix XC4, if the previous procedure does not perform as specified, follow the option below:

- Follow all previous steps but instead of pressing Start and Pause/Cancel buttons, press and hold **Options** and **Pause/Cancel** buttons.

If the washer is a **Better Model**, the error code will appear in the display.

Troubleshoot problem by using chart on next page.

If the washer is a **Good Model**, the five indicator lights of **Door Lock, Wash, Rinse, Final Spin and Control** will flash the number of times for the first digit of the code and the **START** indicator light will flash the number of times for the second digit. Take separate counts of each indicator light, then repeat to confirm in order to be accurate in identifying the proper error code. The code is obtained by counting the number of times the lights flash. Example E24: The five indicator lights would flash twice indicating the 2 and the **START** indicator light will flash four times indicating the 4. The five indicator lights and the **START** indicator light start flashing at the same time. The control will pause for 2 seconds, then repeat the code as long as the two buttons are pressed and held.

Note: A letter appearing in the code stands for a number higher than nine.

A = 10 B = 11 C = 12

D = 13 E = 14 F = 15

Example Code EF1: the first digit would be 15 and the second digit would be 1. If this code would appear on a washer in the **Good** model line, the five indicator lights would blink fifteen times and the **START** indicator light would blink once.

Troubleshoot problem by using chart on next page.

Examples: Identifying Error Codes on non-digital display models:

The following LED Flashes and Beeps signal E41 (Error code 41) Door Open

	COUNT>>>>>>	1	2	3	4	5	6	7	8	9	A	B	C	D	E	F
1st Code Digit	5 Vertical LED Flashes	X	X	X	X											
2nd Code Digit	Start LED Flashes	X														

The following LED Flashes and Beeps signal E14 (Error code 14) Reed Switch

	COUNT>>>>>>	1	2	3	4	5	6	7	8	9	A	B	C	D	E	F
1st Code Digit	5 Vertical LED Flashes	X														
2nd Code Digit	Start LED Flashes	X	X	X	X											

The following LED Flashes and Beeps signal EF1 (Error code F1) Clogged Pump

	COUNT>>>>>>	1	2	3	4	5	6	7	8	9	A	B	C	D	E	F
1st Code Digit	5 Vertical LED Flashes	X	X	X	X	X	X	X	X	X	X	X	X	X	X	X
2nd Code Digit	Start LED Flashes	X														

Failure code chart		
Failure code	Fault condition	Check
E11	Fill time too long.	Refer to test (1).
E13	Water leak in tub or air leak in air bell.	Refer to test (2).
E14	Reed switch.	Refer to test (3).
E21	Water not pumping out fast enough.	Refer to test (4).
E23	Drain pump relay on control board failed.	Replace control board.
E24	Drain pump relay on control board failed.	Replace control board.
E31	Better models. Pressure sensor not communicating with control board.	Refer to test (5).
E35	Better models. Pressure sensor indicates water overflow.	Refer to test (6).
E41	Control board thinks the door switch is open.	Refer to test (7).
E42	Door remains locked after cycle is completed.	Refer to test (8).
E43	Control board problem.	Replace the control board.
E44	Control board problem.	Replace the control board.
E45	Control board problem.	Replace the control board.
E46	Control board problem.	Replace the control board.
E47	Board thinks the door PTC circuit is open in spin.	Refer to test (9)
E48	Board thinks the door PTC circuit is closed.	Refer to test (9)
E52	Bad signal from tachometer generator.	Refer to test (10)
E55	Motor overheating.	Refer to test (11)
E56	High motor current.	Refer to test (11)
E57	High current on inverter.	Refer to test (11)
E58	High current on motor phase.	Refer to test (11)
E59	No tachometer signal for 3 seconds.	Refer to test (12)
E5A	High temperature on heat sink.	Replace the speed control board.
E5B	High temperature on heat sink.	Replace the speed control board.
E5C	High temperature on heat sink.	Replace the speed control board.
E5D	Communication problem.	Refer to test (13)
E5E	Communication problem.	Refer to test (13)
E5F	Communication problem.	Refer to test (13)
E67	Input voltage on microprocessor incorrect.	Replace the control board.
E75	Better models only. Water temperature sensor circuit.	Refer to test (14)
E76	Better model only. NTC temperature for the cold water valve over the limits.	Hot and cold water hoses switched.
E95	Communication error.	Replace the control board.
EB1	Incoming power frequency out of limits.	Refer to test (15)
EB2	Incoming line voltage above 130 VAC.	Check voltage at the outlet. If below 130 VAC, replace the control board.
EB3	Incoming line voltage below 90 VAC.	Check voltage at the outlet. If above 90 VAC, replace the control board.
EF1	Clogged drain pump.	Unclog the drain pump.
EF2	To much soap.	Advise customer to reduce the amount of soap they are using.

Test		
Test	Check	Correction
Test 1:	1. Is the incoming water flow normal?	Yes. Go to step (4). No. Go to step (2)
	2. Are the incoming water faucets turned	No. Turn water faucets on. Yes. Go to step (3).
	3. Is the incoming water pressure above (30) psi.	No. Have customer correct pressure problem. Yes. Check for kinked or blocked incoming water hoses, clean the incoming water screens. If problem still remains, replace the water inlet valve assembly.
	4. Does the fill water continue enter the washer?	Yes. Go to step (5). No. Go to step (6)
	5. Remove power from the washer. Did the water fill stop?	Yes. Go to step (6) No. Replace the inlet valve assembly.
	6. Good models, check the pressure switch.	Pressure switch checks good. Go to step (8). Pressure switch checks bad. Replace pressure switch.
	7. Better models, replace the pressure sensor.	If this did not correct the problem, go to step 8.
	8. Replace the control board.	
Test 2:	1. Is the washer leaking water?	Yes. Correct water leak. No. Go to step (2)
	2. Is there an air leak in the air bell system?	Yes. Correct the air leak problem. No. Go to step (3-4)
	3. Good models, check the pressure switch.	Defective. Replace the pressure switch. Good. Go to step (5)
	4. Better models, replace the pressure sensor.	If this did not correct the problem, go to step 5.
	5. Replace the control board.	
Test 3:	1. Is the dispenser drawer closed?	No. Close the drawer. Yes. Go to step (2).
	2. Remove the drawer and check the magnet.	Magnet missing or defective. Replace the magnet. Magnet good. Go to step (3).
	3. Open the console and check the reed switch.	Defective. Replace the reed switch. Good. Replace the control board.
Test 4:	1. Check the drain hose for restrictions.	Restriction. Correct problem. No restriction. Go to step (2).
	2. Start the washer and check for 120 VAC at the drain pump.	Zero. Replace the control board. 120 VAC. Remove the pump and check for blockage. If blocked, remove the restriction, if not, replace the pump.
Test 5:	Inspect the wiring between the pressure sensor and the control board.	Defective wiring. Correct wiring. Good wiring. Replace the pressure sensor. If this does not correct the problem, replace the control board.

Test		
Test	Check	Correction
Test 6:	1. Is the water level above 4.5 inches?	Yes. Go to step (2). No. Go to step (4).
	2. Does water enter the washer continuously.	Yes. Go to step (3). No. Replace the control board.
	3. Remove power from washer. Does the water stop coming in?	No. Replace water valve assembly. Yes. Check wiring to valve assembly for shorts. If wiring is good, replace the control board.
	4. Replace the pressure sensor switch. Did this correct the problem?	Yes. Problem solved. No. Replace the control board.
Test 7:	1. Is the loading door closed?	No. Close the door. Yes. Go the step (2).
	2. Disconnect the plug from J2 on the control board and check for continuity between the pins in the plug.	Open. Check the door strike. If good, replace the door switch assembly. Closed. Replace the control board.
Test 8:	1. Remove power from the washer. Wait one minute. Can you open the door?	Yes. Replace the control board. No. Replace the door switch assembly. Note: You may have to break the door strike to do this.
Test 9:	1. Remove the door lock assembly and measure the resistance of the PTC.	Shorted or open. Defective door lock assembly. Reads around 1500 Ohms. Defective control board.
Test 10:	1. Disconnect the plug from the drive motor and measure the resistance pins 4 & 5 in the motor.	If the reading is between 105 & 130 Ohms, replace the speed control board. If the meter reads other than between 105 & 130 Ohms, replace the motor.
Test 11:	1. Remove the belt from the motor and spin the motor pulley. Does the motor spin free?	No. Replace the motor. Yes. Go to step (3)
	2. Spin the tub pulley. Does the tub spin free?	No. Check the tub bearings. Yes. Go to step (3)
	3. Disconnect the plug from the motor and measure the resistance of the windings (pin 1 to pin 2, pin 1 to pin 3, pin 2 to pin 3). All readings should be between 4 and 6 Ohms.	If the readings are correct, replace the speed control board. If the readings are incorrect, replace the motor.
Test 12:	1. Remove the belt from the motor and spin the motor pulley. Does the motor spin free?	No. Replace the motor. Yes. Go to step (3)
	2. Spin the tub pulley. Does the tub spin free?	No. Check the tub bearings. Yes. Go to step (3)
	3. Disconnect the plug from the drive motor and measure the resistance between pins 4 & 5 in the motor.	If the meter reads other than between 105 & 130 Ohms, replace the motor. If the reading is between 105 & 130 Ohms, Go to step (4)
	4. Disconnect the plug from the motor and measure the resistance of the windings (pin 1 to pin 2, pin 1 to pin 3, pin 2 to pin 3). All readings should be between 4 and 6 Ohms.	If the readings are correct, replace the speed control board. If the readings are incorrect, replace the motor.
Test 13:	1. Communication problem. Check the wiring between the control board and the speed control board.	Wiring bad. Correct wiring problem. Wiring good. Replace the control board. If the problem is not corrected, replace the speed control board.
Test 14:	1. Check the resistance of the NTC. Is it around 50K ohms?	No. Replace the water inlet valve assembly Yes. Replace the control board.
Test 15:	1. Have the power company check the frequency of the incoming power. If correct, replace the control board.	

Jacks and plugs

Control panel

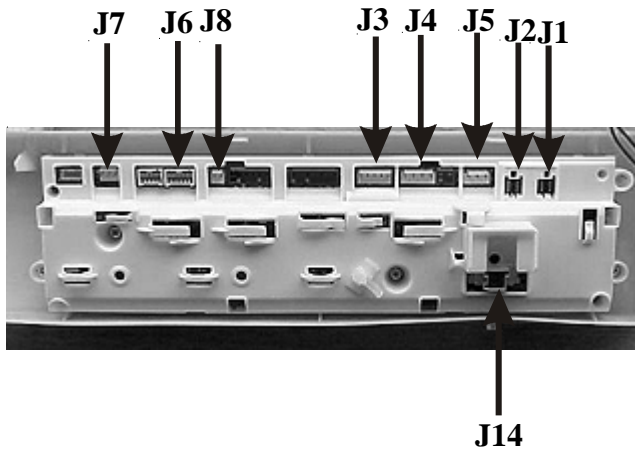

Control board circuits:

- J1 Power to the speed control board.
- J2 & J3 Door switch assembly circuits.
- J4 & J5 Water inlet and drain pump circuits.
- J6 Codes to the speed control board.
- J7 Thermal sensor circuit. (Some models)
- J8 Reed switch circuit.
- J14 Incoming power.

Speed control board

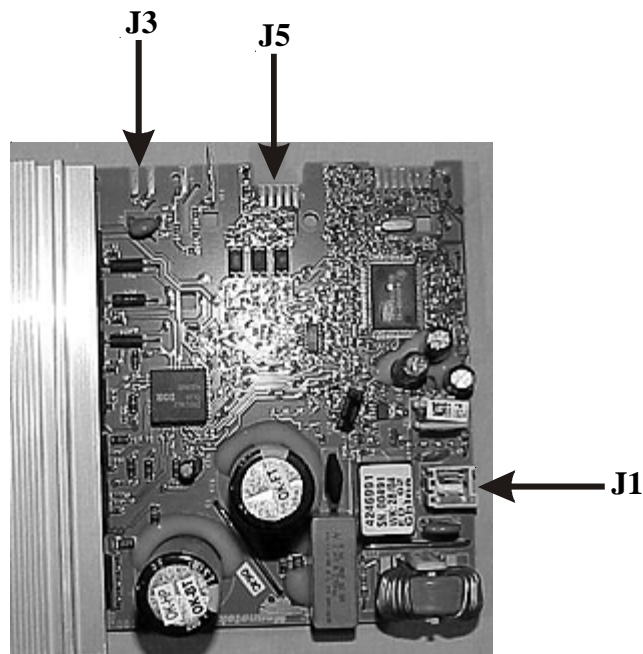

Speed control board circuits:

- J1 Line to neutral voltage from control board.
- J3 Code inputs from control board.
- J5 Outputs to the motor windings and tacho generator.

Motor plug

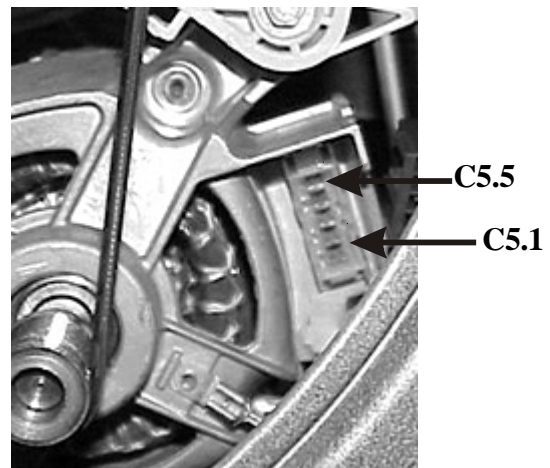

Motor connections:

- C5.1, C5.2 & C5.3 Motor winding connections.
- C5.4 & C5.5 Tacho generator connections.

SECTION H- TEARDOWN

This section will describe how to remove components from the 3.0 horizontal axis washer. Unless stated, the procedure will be the same on all models. Unless stated, reverse the procedure to reinstall the component.

⚠ WARNING Always remove electrical power from the washer when working in an area where electrical power is present.

Removing the detergent drawer:

1. Slide the safety latch lever to the right and pull the drawer out until it hits the stop.



2. Push down on the release tab and pull the drawer out.



Detergent drawer disassembly:

1. Remove the drawer from the washer.

2. The detergent, liquid bleach and fabric softener insert lifts off. When reinstalling, be sure to seat it properly.

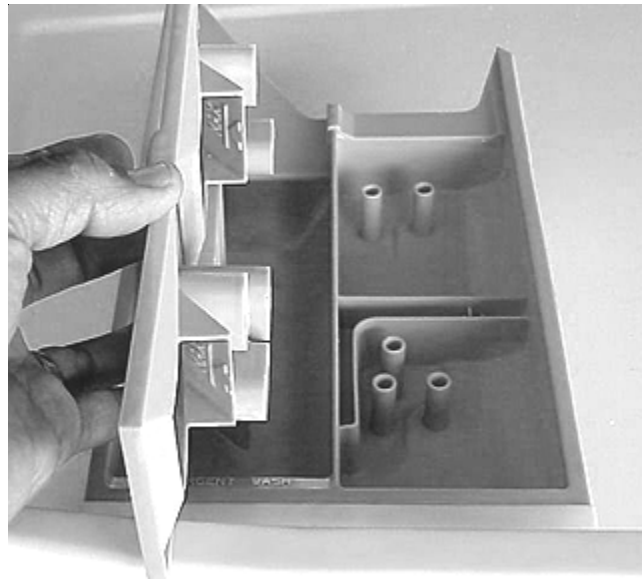

3. To remove the drawer front, release the three tabs and pull the drawer front away from the body. When replacing the drawer front always remember to transfer the reed switch magnet.

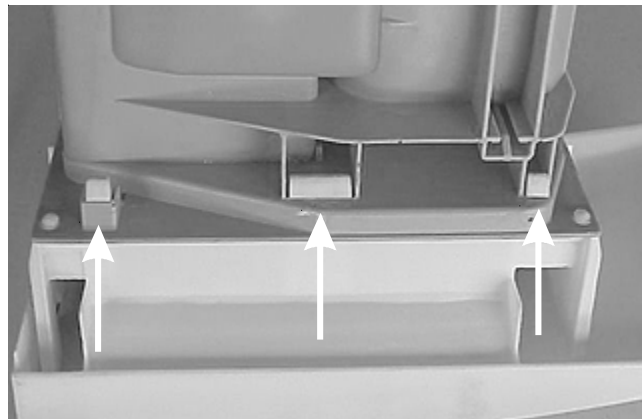

4. To remove the conveyor release the conveyor from the tabs and lift it off.

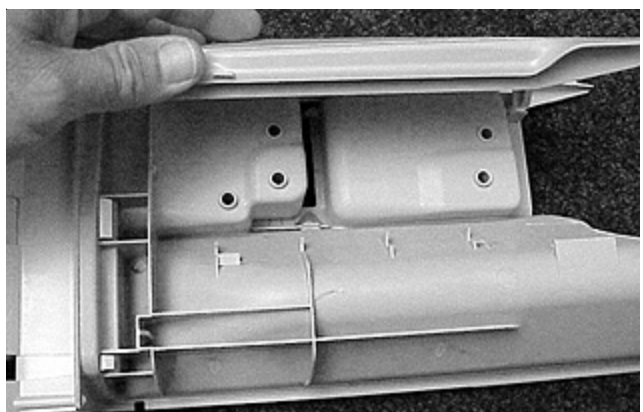

5. To remove the safety latch lever, compress the spring by moving the lever completely to the left and lift the lever out.

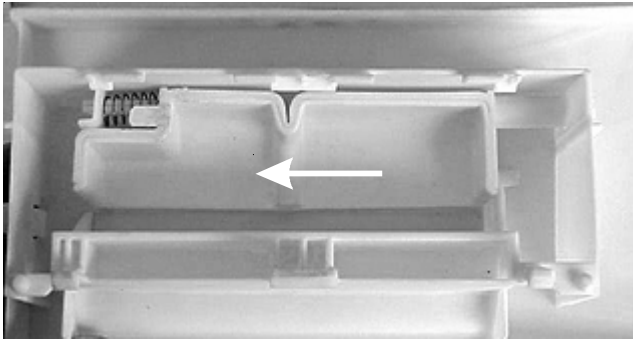

6. To remove the magnet, push the tab to the right with a small screw driver.

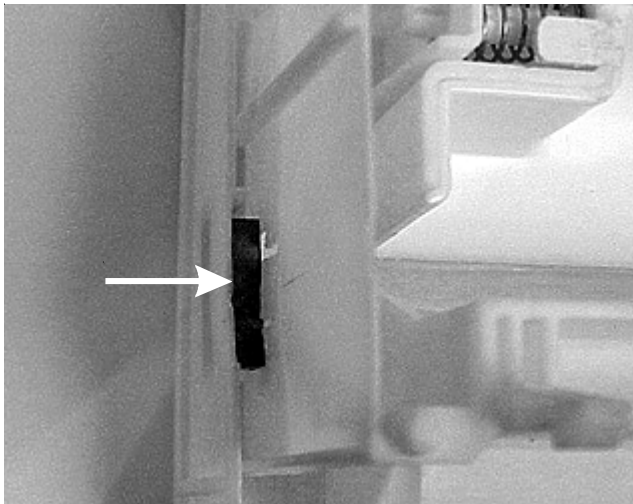

To remove loading door handle:

1. Remove the (2) screws holding the handle to the inner liner of the door.



To remove loading door:

1. Remove the door by removing the (4) screws holding the door to the hinges while supporting the door.

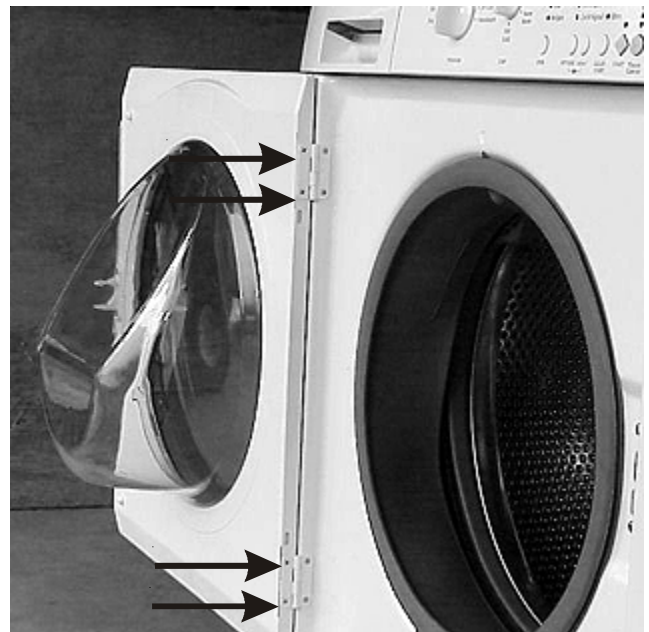

To remove door strike:

1. Open loading door and remove the (2) screws holding the strike to the inner door liner.

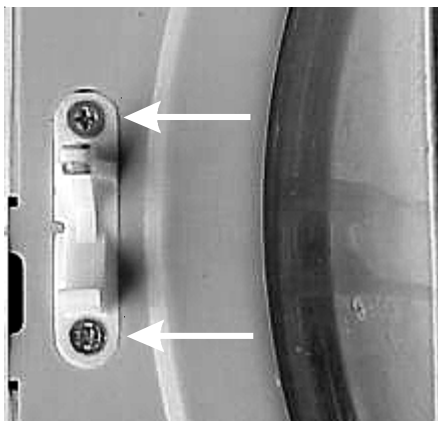

Disassembling the door:

1. To remove the outer door panel, separate the two panels on the hinge side and slide the outer panel toward the door strike side to disengage the inner panel from the outer panel flange.



2. Remove the outer glass (some models) by removing the door strike and the (4) screws holding the outer glass to the inner panel and lift the glass off.



3. The inner glass is held in place by (5) molded tabs in the rear door cover. To remove the glass, grab the edge of the cover by the tab and twist it away from the glass.

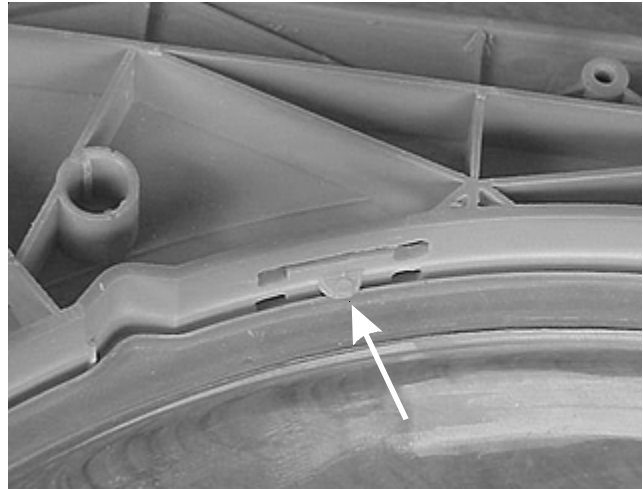

To remove door hinges:

1. Remove the (4) screw holding the hinge to the door and front panel.

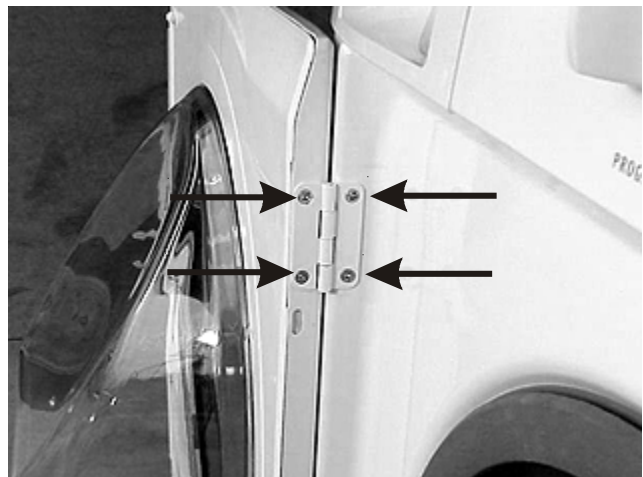

Releasing the bellows (door boot) from the front panel:

The front of the bellows is installed over the lip of the door opening in the front panel and held in place by a spring loaded wire loop.

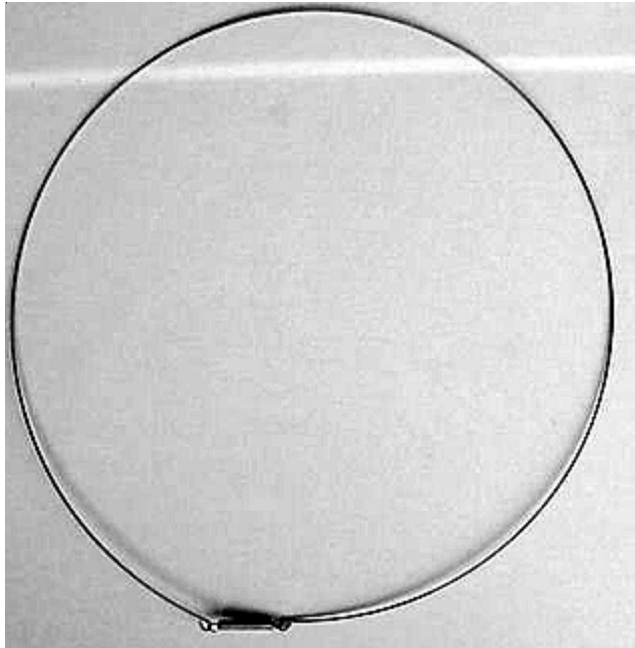

1. Open the loading door.
2. Using needle nose pliers, start where the spring and wire are connected at the bottom of the bellows and pull the wire out of the groove of the bellows.



3. Pull the bellows off of the lip of the front panel.

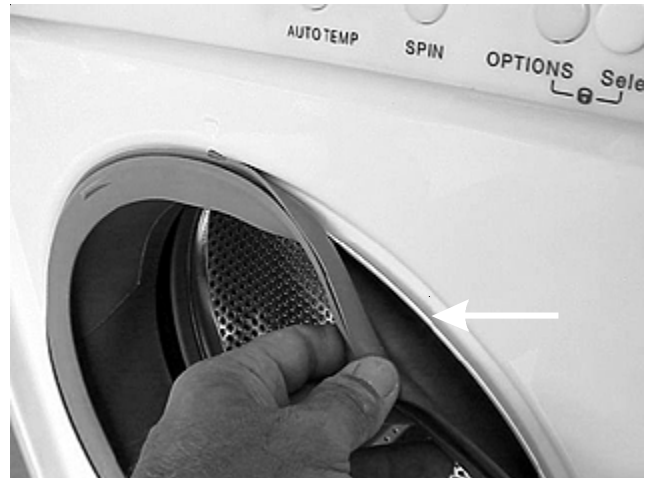

Removing the door safety switch:

1. Disconnect the washer from the electrical supply.
2. Release the bellows from the front panel.
3. Remove the (2) screw holding the switch assembly to the front panel.

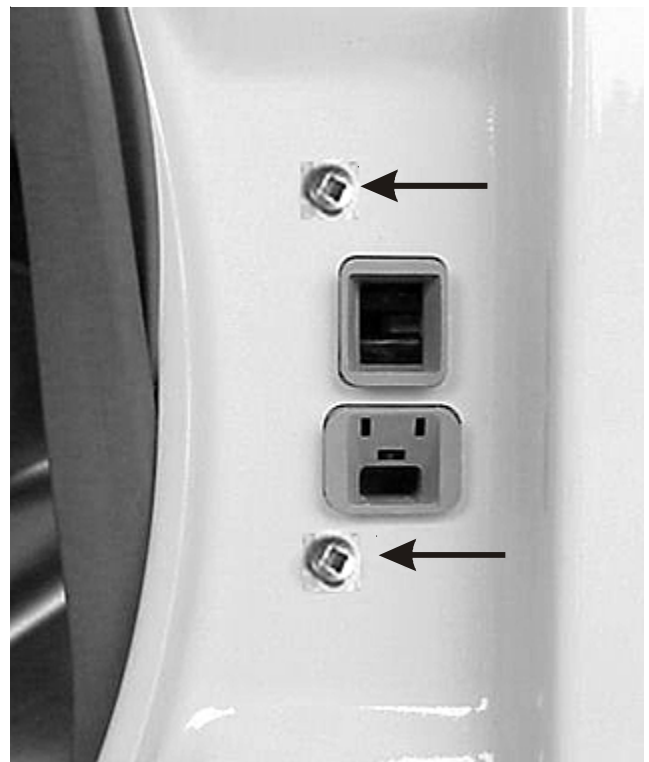

4. Pull the switch assembly into the door opening and unplug the electrical connectors.

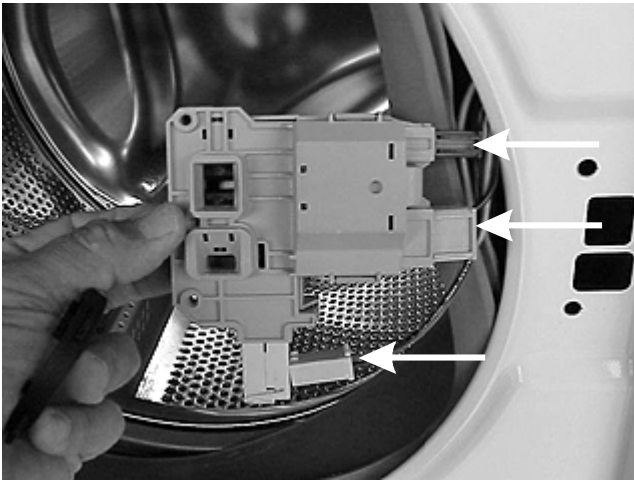

2. Disconnect the inlet sump from the pump.

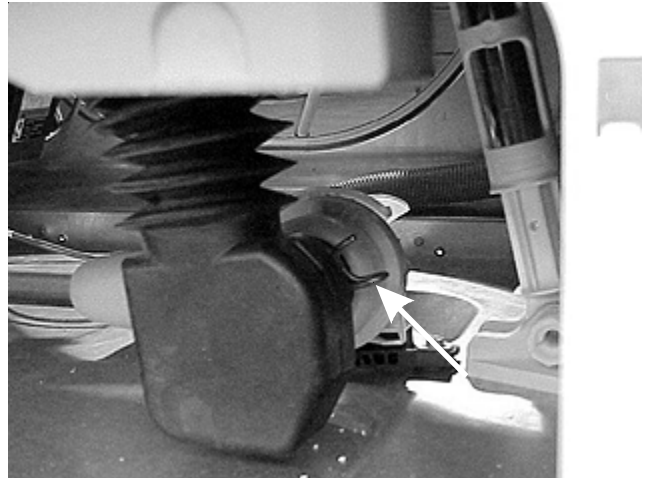

Removing the lower front access panel:

1. Raise the front of the washer and insert a two by four under the front of the washer.
2. Remove the (2) screws holding the panel to the washer base. Pull the panel down and out.

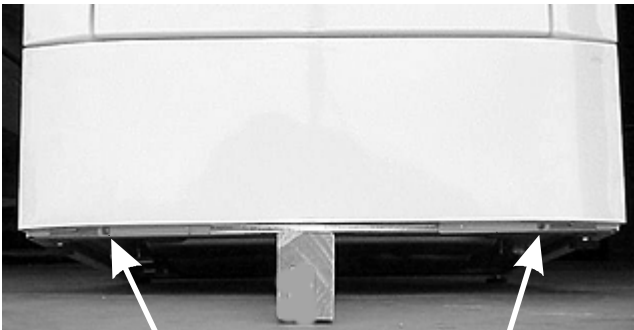

3. Disconnect the outlet hose from the pump.

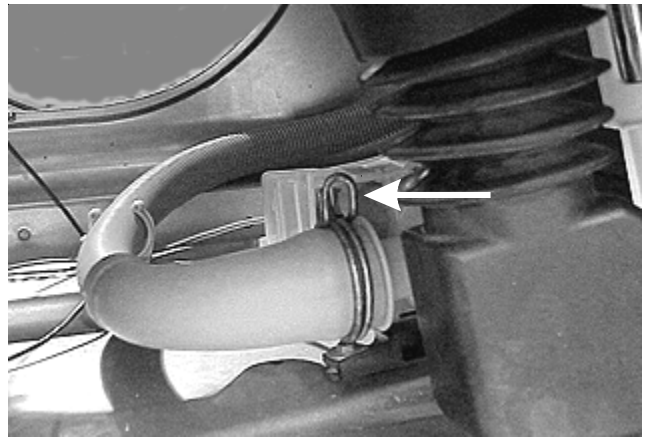

Removing the drain pump:

1. Disconnect the washer from the electrical supply, remove the front access panel.

Note: Some water will be left in the hoses and pump.

4. Remove the (2) screws, one on each side, holding the pump housing to the washer base.

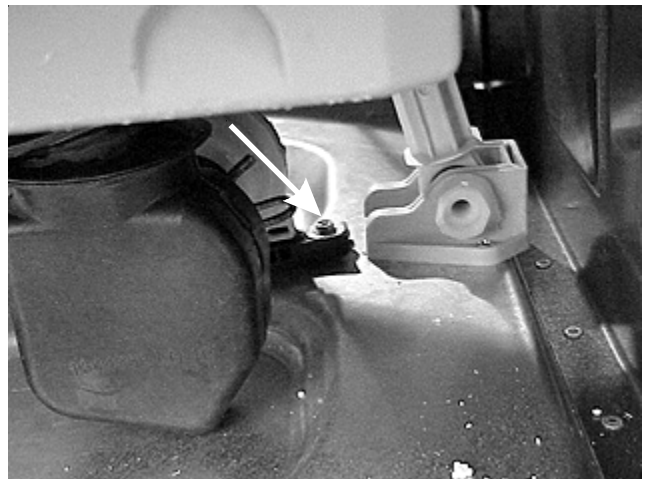

4. Unplug the wires from the pump motor.

Disassembling the drain pump:

1. The drain pump check valve is located in the outlet of the pump.

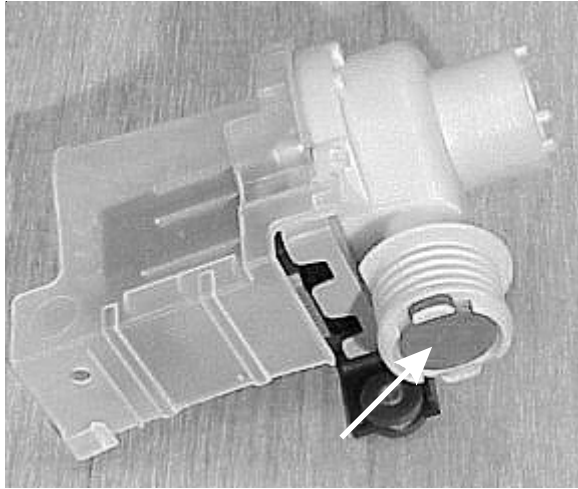

2. Remove the shield by releasing the tab and pulling back on the shield.

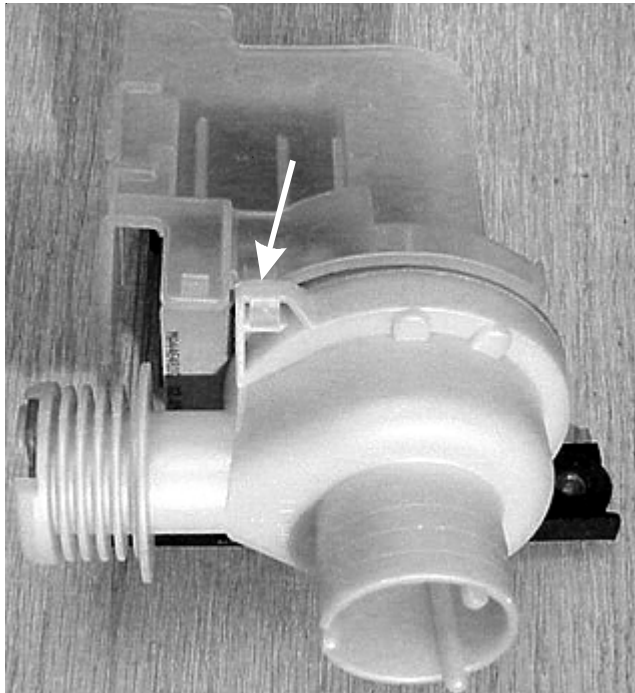

3. Release the tab on each side of the motor and pull back to remove the armature.

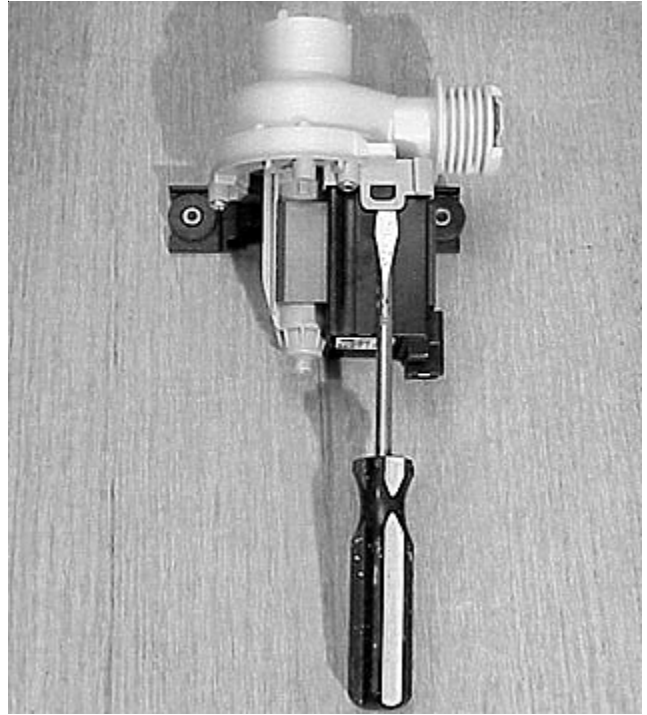

4. Remove (4) screws to release the pump from the housing.

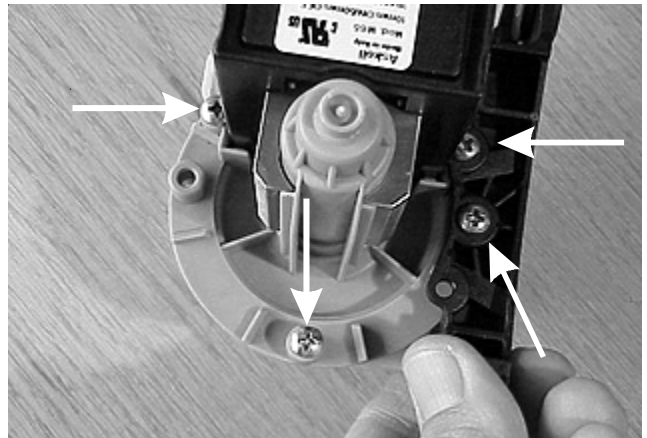

Removing the top panel:

1. Disconnect the washer from the electrical supply.

2. Remove the (2) screws from the rear of the top, slide the top back and lift it off.

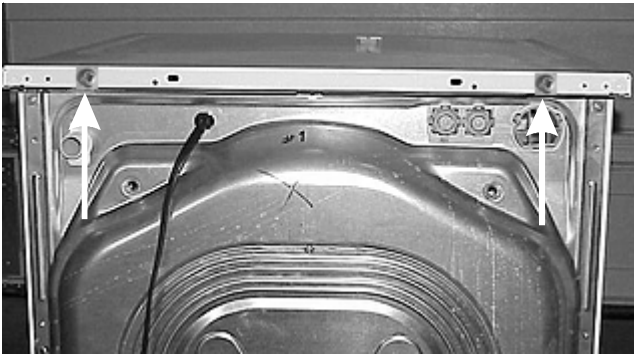

Removing the pressure switch: (Good Models)

1. Disconnect the washer from the electrical supply and remove the top panel.
2. Unplug the wires from the pressure switch.
3. Turn the pressure switch one quarter turn and pull out to release it from the side panel.

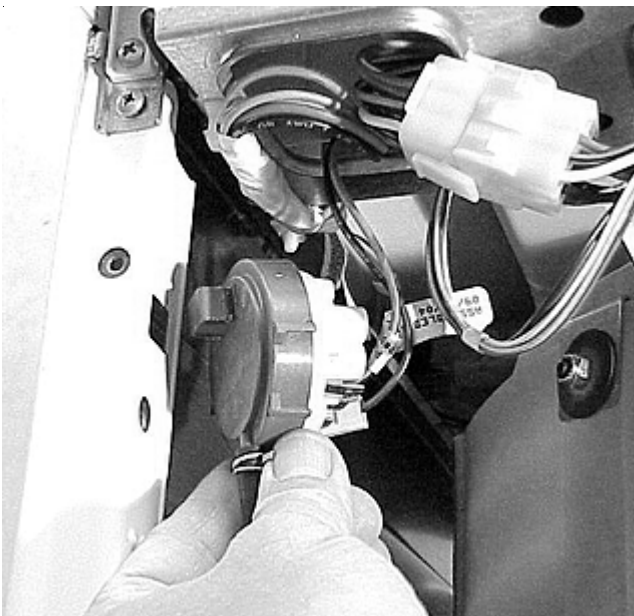

4. Disconnect the hose from the pressure switch.

Removing the electronic water level sensor: (Better Models)

1. Disconnect the washer from the electrical supply and remove the top panel.

2. Unplug the wire harness from the sensor.

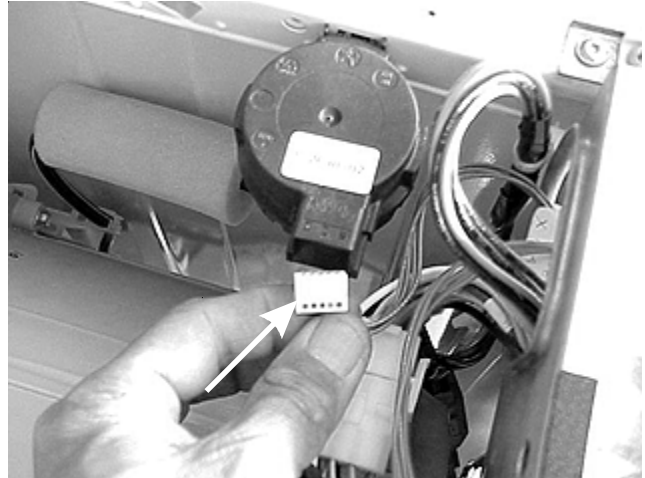

3. Turn the sensor one quarter turn and pull out to release it from the side panel.

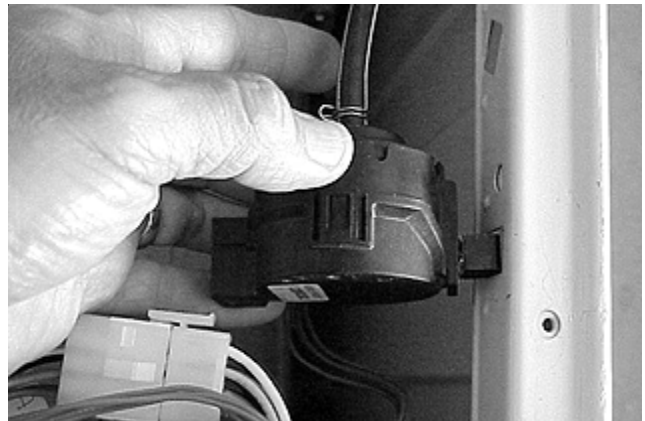

4. Disconnect the hose from the sensor.

Releasing the console:

1. Disconnect the washer from the electrical supply, remove the top panel and detergent drawer.

- Remove the (2) screws, one on each end, holding the console to the top of the side panels.



- Remove the (3) screws behind the detergent drawer panel.

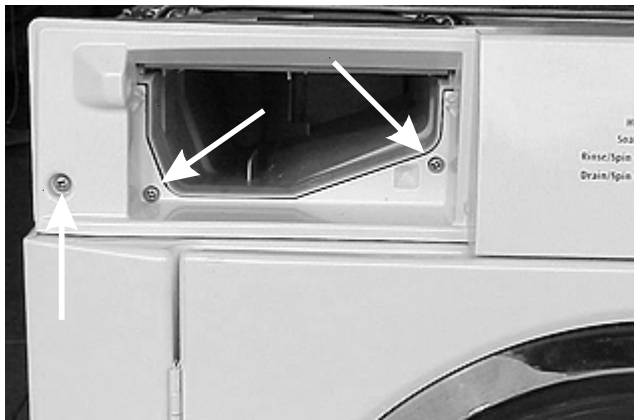

- Release the tab that is spread open by the left hand screw as view from the front.

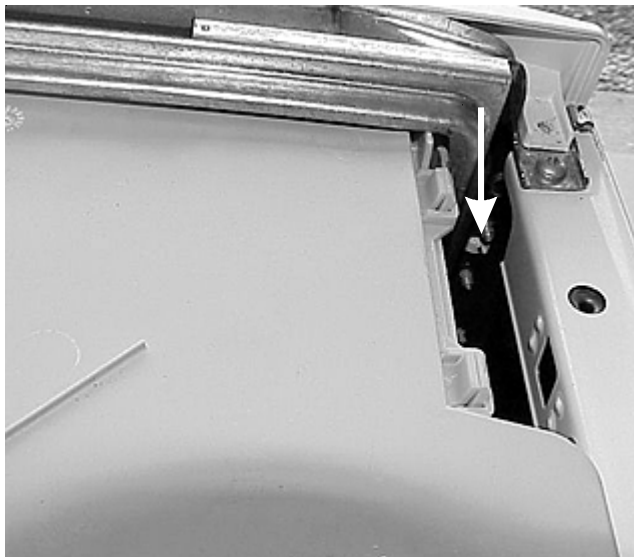

- Release the (3) locking tabs at top rear edge of the console and roll the console forward.

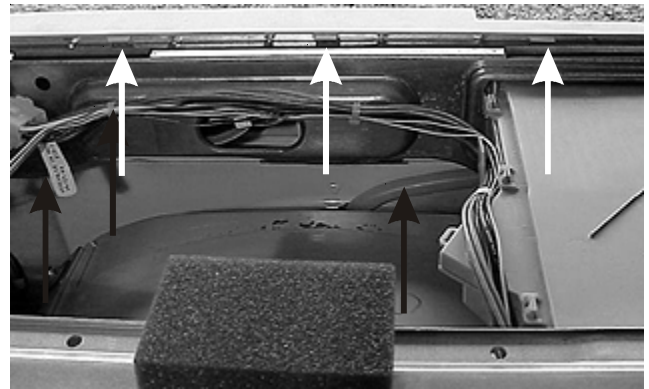

Removing the reed switch:

- Disconnect the washer from the electrical supply and release the console.
- Unplug the reed switch harness from the control and snap the reed switch out of the console.

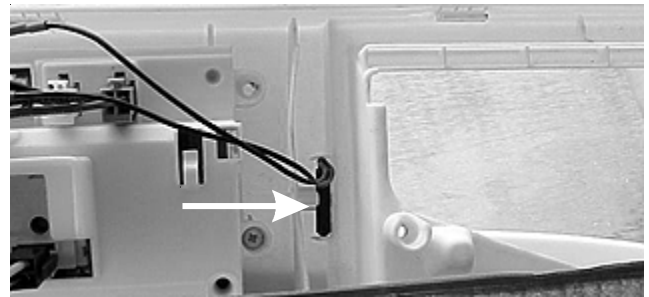

Removing the water temperature selector knob: (Good Models)

- To remove the water temperature selector knob, pull the knob straight off.

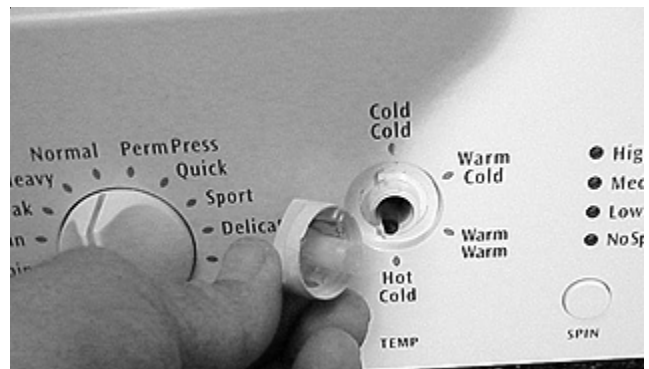

Removing the console:

1. Disconnect the washer from the electrical supply and release the console.
2. Tag each plug with the jack number, then disconnect the electrical harness from the electronic control, release the wire harness rivets from the back of the control and lift the console off .

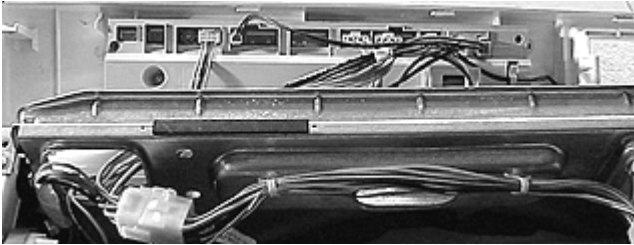

Removing the electronic control:

1. Disconnect the washer from the electrical supply, remove the water temperature knob and the console.
2. Lay the console on a soft flat surface and remove the (4) screws holding the control to the console.

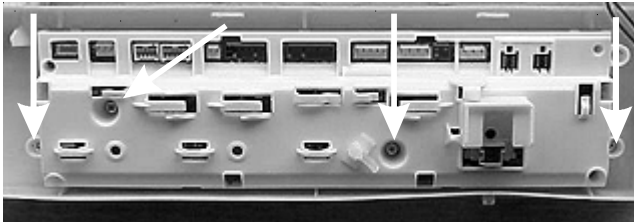

3. Release the locking tabs and lift the control from the console.

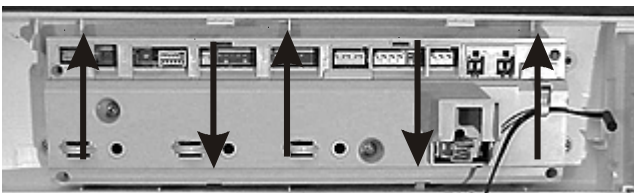

Note: Be careful not to lose the button springs.

Removing the selector knob: (Good Models)

1. Disconnect the washer from the electrical supply and remove the electronic control.

2. Squeeze the rim of the selector knob shaft with pliers and pull the knob out the front.

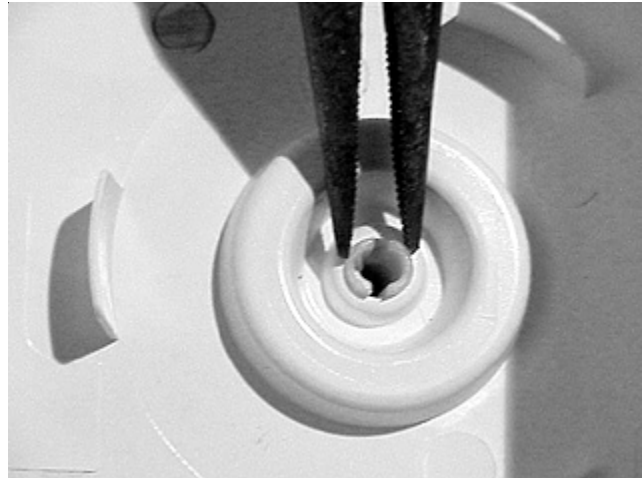

Removing the water temperature selector shaft: (Good Models)

1. Disconnect the washer from the electrical supply, set the water temperature selector knob to the Cold/ Cold position and remove the electronic control.
2. Lift the shaft out of the control.

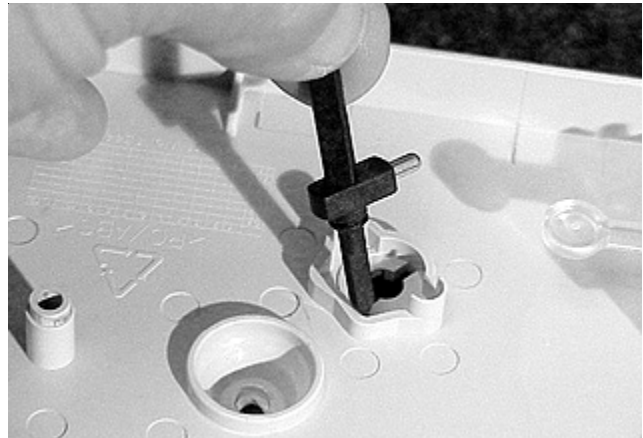

Removing the selector dial: (Better Models)

1. Disconnect the washer from the electrical supply and remove the electronic control.
2. Grab the cone of the dial around the knob shaft with a pair of pliers. Hold the knob and pull with the pliers while slightly twist them back and forth.



Note: Do not use a screwdriver to pry the dial off because it will scratch the dial.

Removing the selector knob: (Better Models)

1. Disconnect the washer from the electrical supply, remove the electronic control and the cycle selector dial.
2. Release the shaft lock by expanding one of the side slots with a screwdriver and pull on the knob.

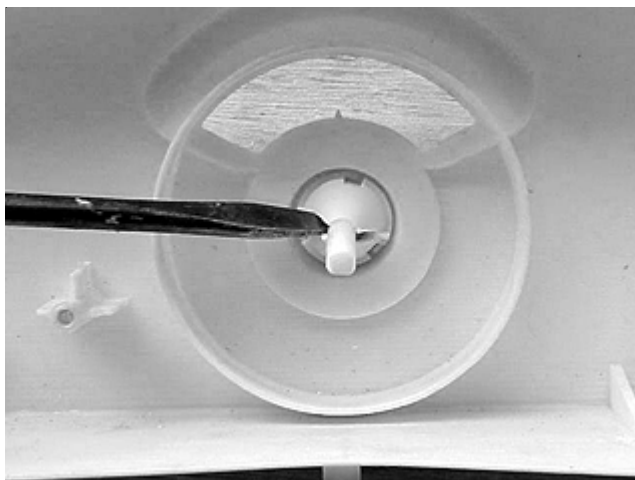

Removing the programing buttons and springs:

1. Disconnect the washer from the electrical supply and remove the electronic control.
2. Lift the buttons and springs out of the console.
3. The buttons are not all the same. Each button has a Roman numeral stamped into it. The console has Roman numeral above the button slot. Match the number on to button to the number on the slot.

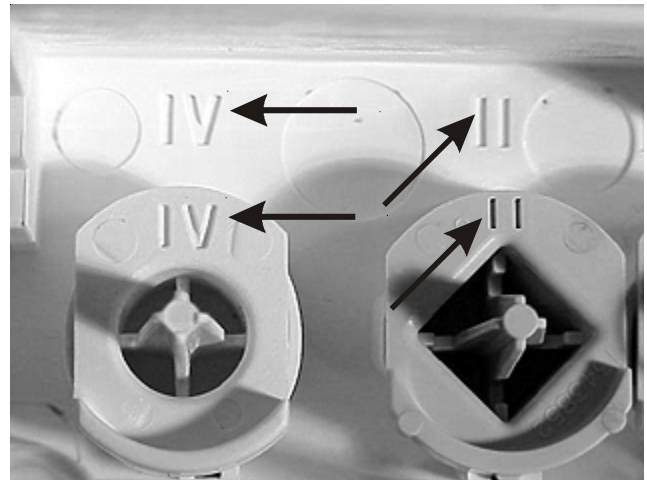

Removing the front panel:

1. Disconnect the washer from the electrical supply, release the console and remove the front access panel.
2. Release the bellows from the front panel and remove the (2) screws holding the door safety switch assembly to the front panel.
3. Release the plastic rivet wire tie holding the door switch harness to the front panel.



- Remove the (3) screws holding the front panel to the front console mounting brace and side panels.



- Remove the (2) 5/16" hex head screws holding the bottom of the front panel to the side panels.

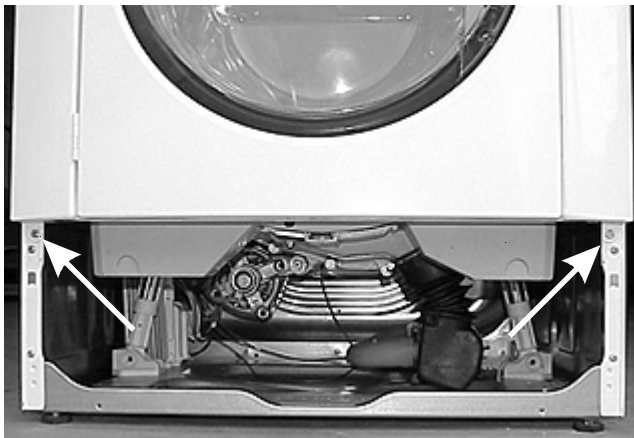

- Lift up on the front panel to disengage from the (2) pins, one in each side panel, that the front panel hooks over.

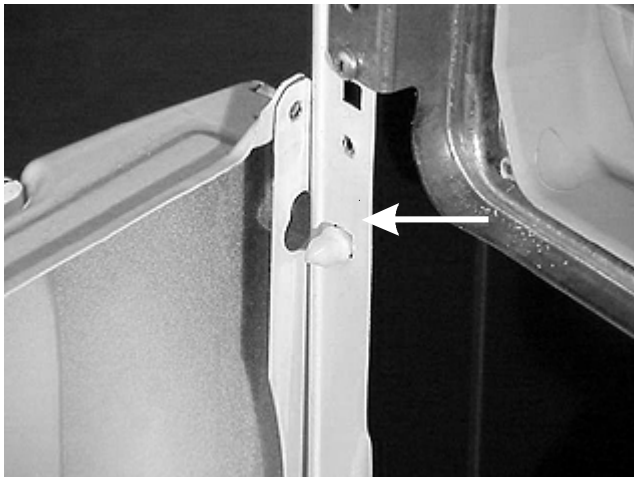

Removing the console mounting brace:

- Disconnect the washer from the electrical supply, remove the console and front panel.
- Release the wiring harness from the back of the brace. Remove the (6) screws, one at the top and two in the front on each side, holding the brace to the side panels.



- Release the (2) tabs on the dispenser drawer housing, one on each side, and pull the brace forward.



Removing the bellows (door boot):

- Disconnect the washer from the electrical supply and remove the front panel.
- Release the hose clamp and remove the advanced

rinsing technology (A.R.T.) hose from the top of the bellows.

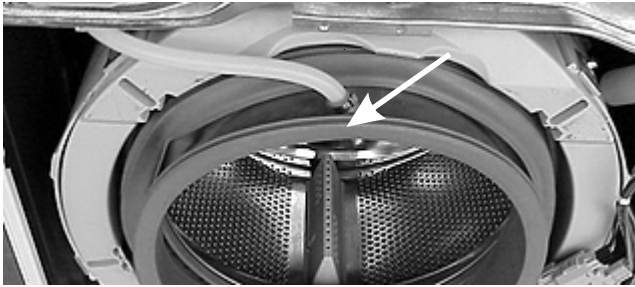

3. A groove in the rear of the bellows

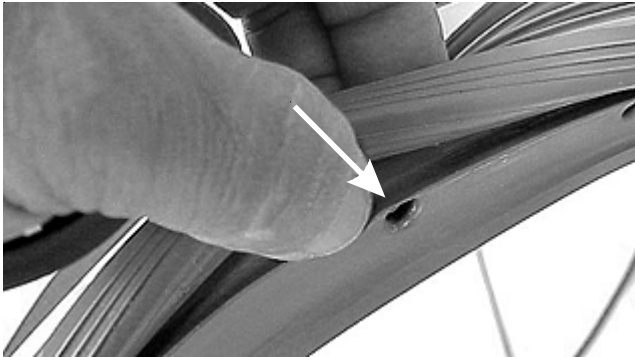

is placed over the lip of the outer tub

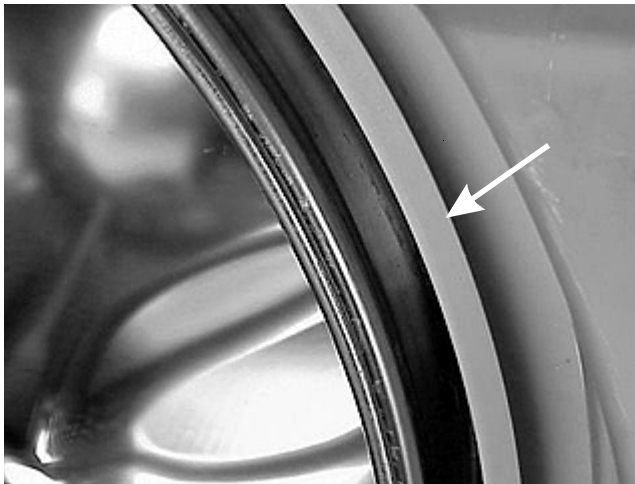

and held in place by a spring loop.

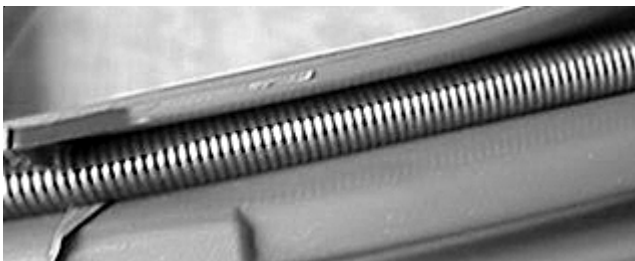

4. Remove the bellows by placing your hand under the bellows at the top of the opening and lift up while pulling out.

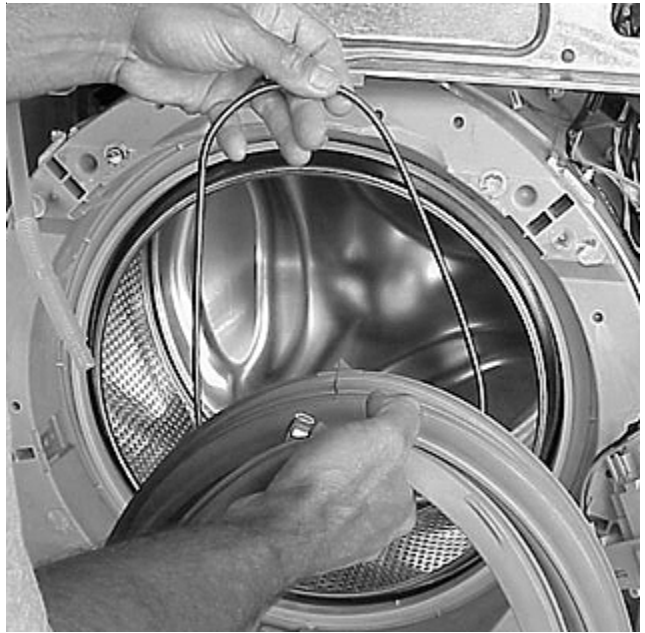
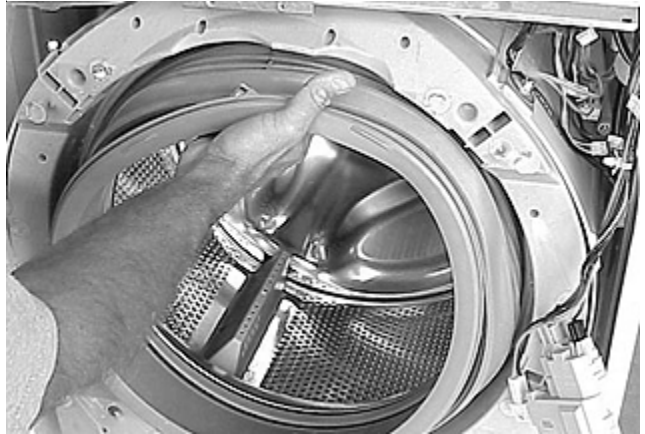

Reinstalling or replacing the bellows:

1. Use liquid dishwasher soap to lubricate the groove on the bellows to make it easier to slip the groove of the bellows onto the lip of the tub.

2. There is a tab and an arrow on the top of the tub lip

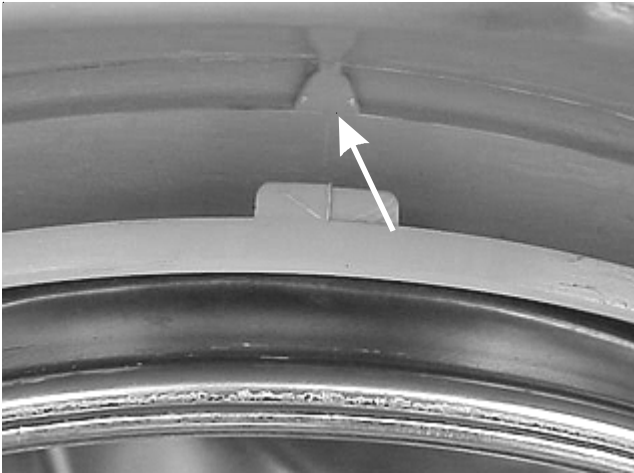

and a slot in the groove and an arrow at the top of the bellows.

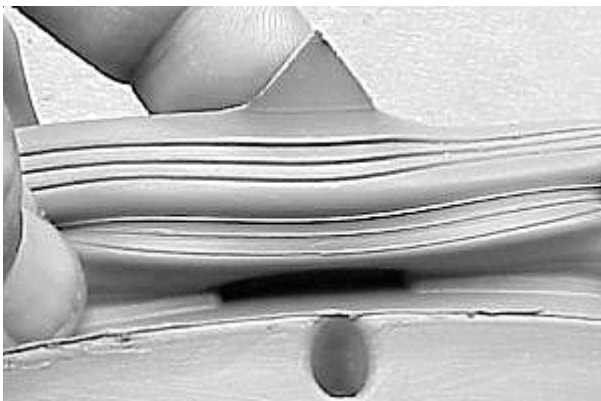

3. Place the slot over the tab and while holding the bellows in place with one hand, place the other hand inside the bellows and force the groove of the bellows over the lip of the tub with your thumb.



4. Work your way about one third way around the tub, then pull in on the inside flap of the bellows to seat the bellows into the lip of the tub.



5. Using your thumb, start on the other side of the top tab and force the bellows on in the other direction. Again about one third of the way around stop and seat the bellows onto the tub lip. Then force the remaining bellows on with your thumb and seat it.

6. To install the spring, fold the front of the bellows back into the tub.



- Place the spring in the groove at the top of the bellows and wedge a round object, about 3/4 " in diameter, between the weight ring and the bellows to hold the spring in the groove.

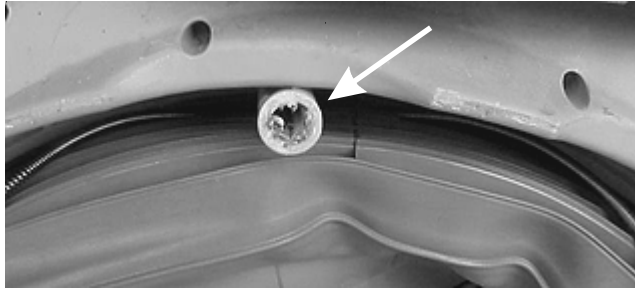

- Pull the spring with one hand while working it into the groove with the other.

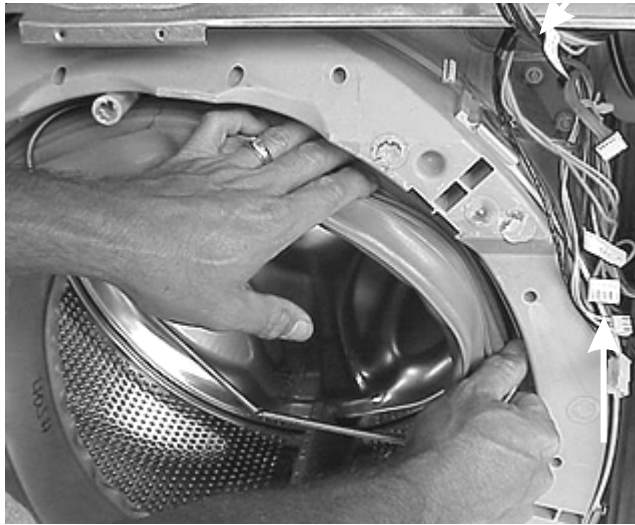

- Remove the wedge, unfold the bellows, and insert the advance rinsing technology hose .

Removing the weight ring:

- Disconnect the washer from the electrical supply, remove the front panel and disconnect the advance rinsing technology hose from the bellows.

- Using a 7/16" socket, remove the (5) bolts holding the weight ring to the outer tub and slide the weight ring off the outer tub front.



The water inlet and overflow/vent tube grommet:

Note: The water inlet and overflow/vent tube grommets are connected for ease of installing during manufacturing and can be separated by cutting the thin wall joint section for removal in the field.

Removing the water inlet grommet:

- Disconnect the washer from the electrical supply, remove the top panel and cut the thin wall joint section between the water inlet and the overflow/vent tube grommet .

- Using a small common screw driver, release the (8) locking tabs around the water inlet tubes while pushing on the grommet rim from inside the washer.

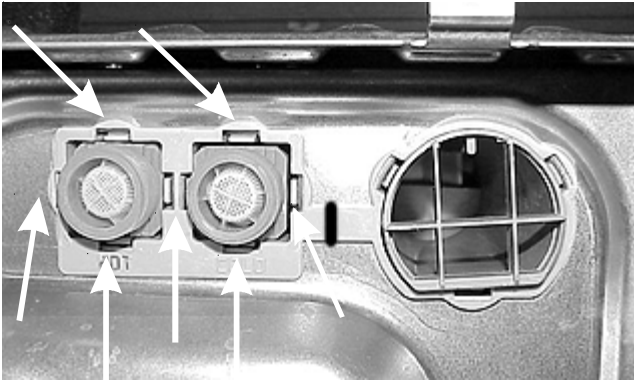

Removing the overflow/vent tube grommet:

- Disconnect the washer from the electrical supply, remove the top panel and cut the thin wall joint section between the water inlet and the overflow/vent tube grommet.
- Using a small common screw driver release the (3) locking tabs around the overflow/vent tube while pushing on the grommet rim from inside the washer.

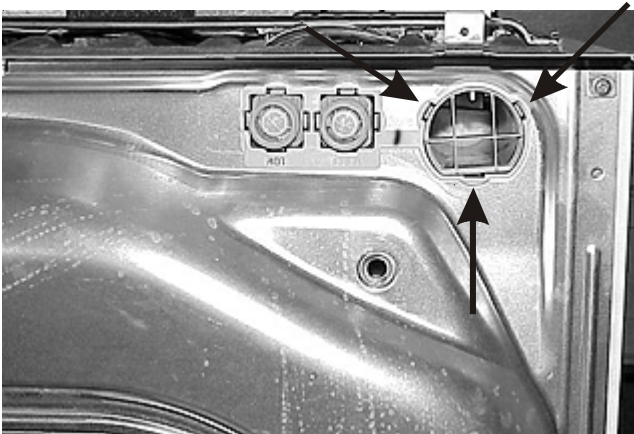

Removing the overflow/vent tube:

- Disconnect the washer from the electrical supply remove the top panel and remove the overflow/vent grommet.

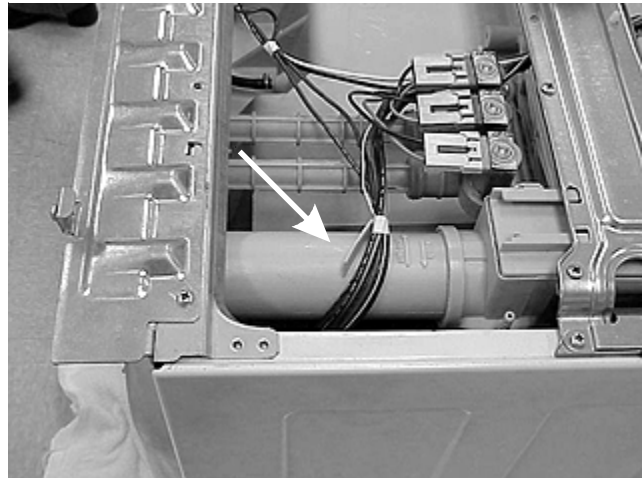

- Turn the tube counter clockwise about a 1/16 of a turn to unlock the tube. Pull the tube back to disengage it from the detergent dispenser housing.

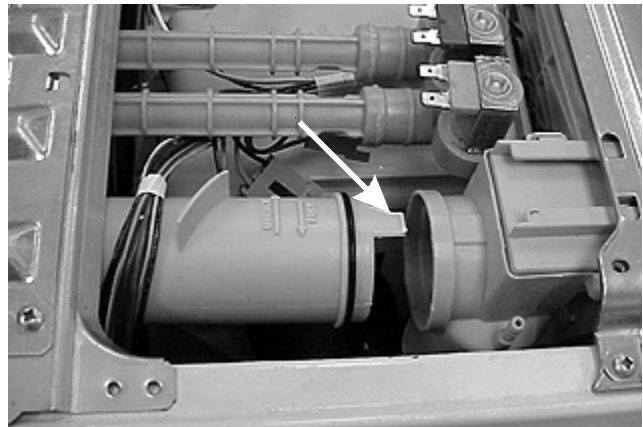

- Push the front of the tube down and forward toward the water inlet valve assembly until the tube clears the rear panel.

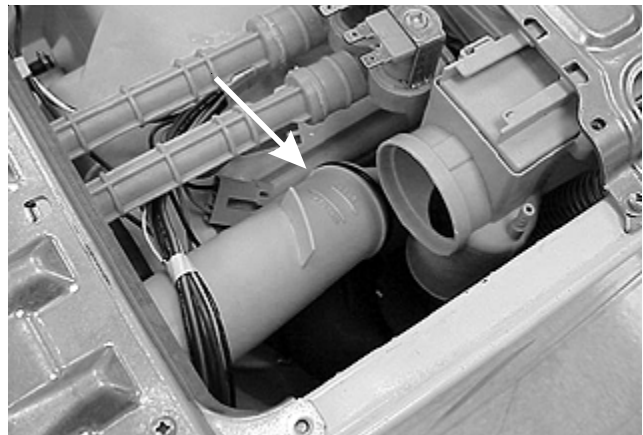

- Drop the rear of the tube down, slide the tube back and lift the tube out.

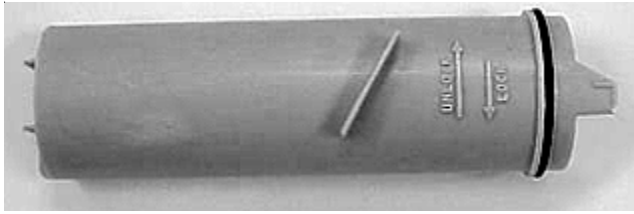

Removing the water inlet valve assembly:

Note: The water valves and water valve harness connectors are color coded: red, green and blue. When reconnecting, match the color on the harness connector to the color of the valve.

- Disconnect the washer from the electrical supply and the hot and cold water hoses.
- Remove the top panel, water valve and overflow/vent grommet and the overflow/vent tube.
- Unplug the wiring harness from the valves and the temperature sensor. (Some Models)

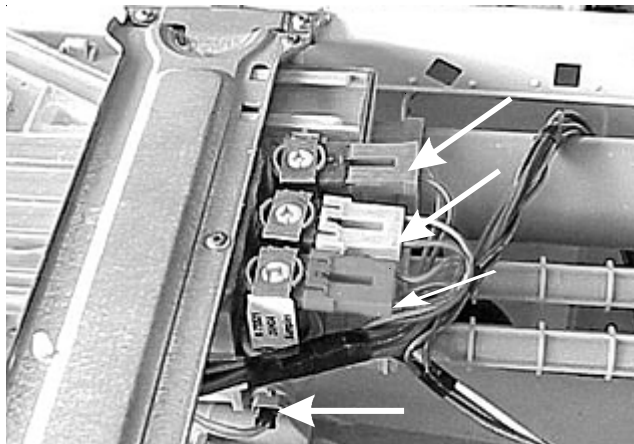

Note: The water valves harness has locking plugs.

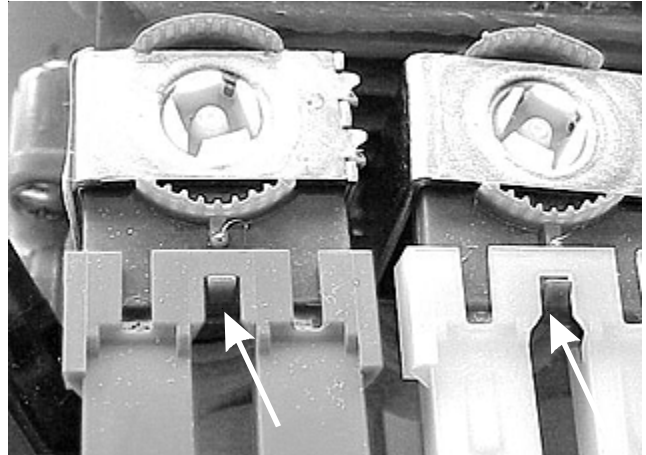

- Remove the (2) screws, one on each side, holding the water inlet valve assembly to the detergent dispenser housing.

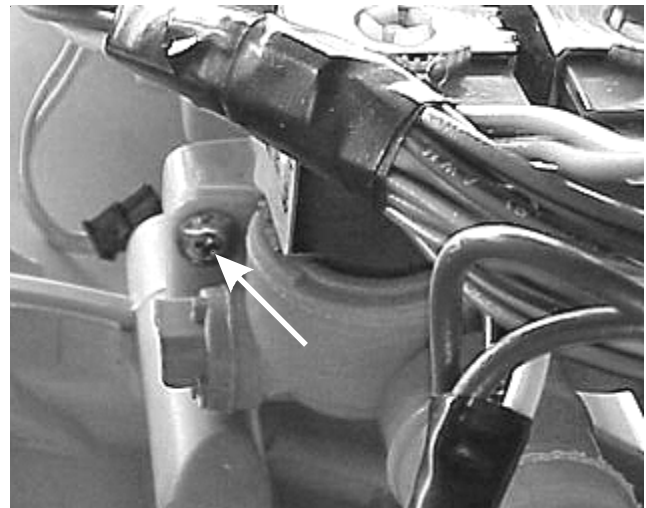

5. Pull back on the valve assembly to disengage it from the detergent dispenser housing and lift it out.

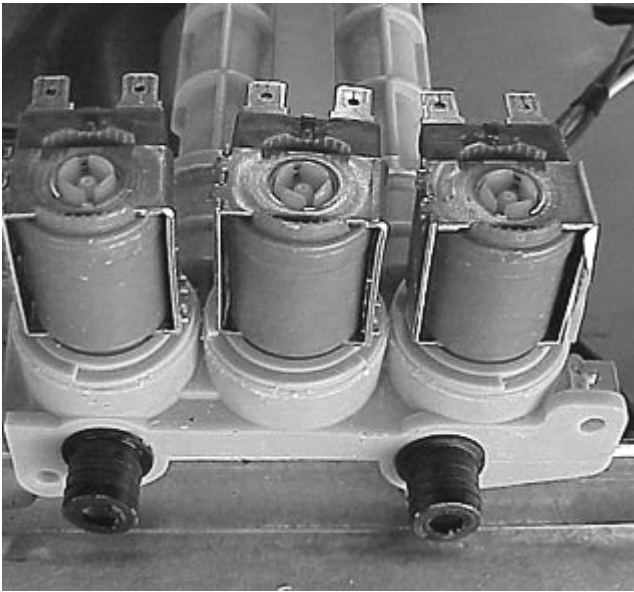

Removing the water inlet screens:

Water inlet screens are located in the ends of the water inlet tubs to filter the incoming water. These screen can be removed for cleaning.

1. Disconnect the incoming water hoses.
2. The screens have a **X** molded them. Using pliers grab one of the legs of the **X** and pull the screen out.

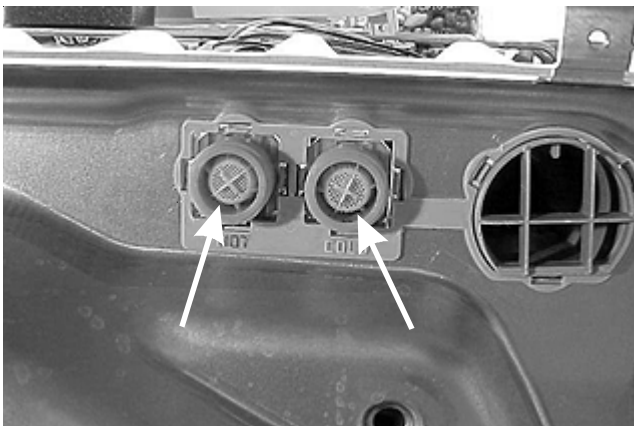

Removing the top rear brace:

1. Disconnect the washer from the electrical supply and remove the top panel.

2. Remove the (3) screws from the top of the brace.

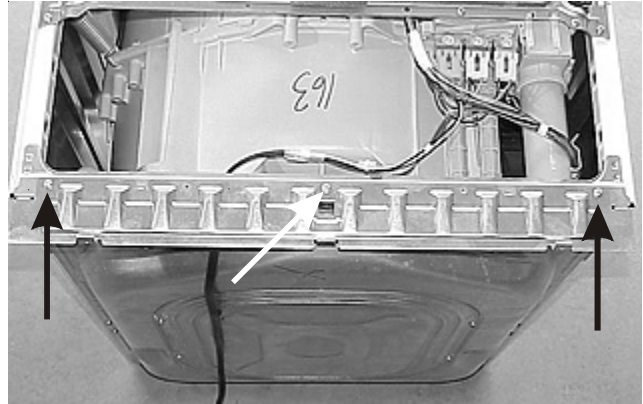

3. Remove the (2) screws from the rear of the brace.



4. Pull back to disengage the (2) tabs and lift the brace off.

Removing the suspension springs:

1. Disconnect the washer from the electrical supply and remove the top panel.
2. It is necessary to hook the top of the spring, raise it about 1" to release the top hook from center brace flange, then allow it to drop about 6" to relieve the spring pressure and then unhook the other end of the spring from the tub.

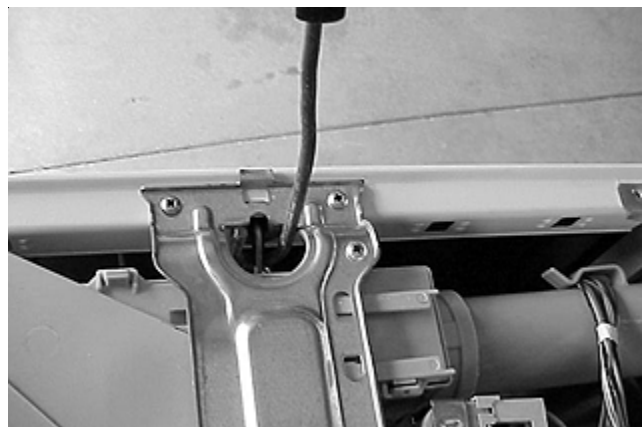

To do this, a strong rod at least 8" long with a hook on one end and a handle on the other is need, such as the one shown here made from a paint roller.



Note: When removing the spring on the side with the detergent dispenser, the overflow/vent tube must be removed.

Removing the top center brace:

1. Disconnect the washer from the electrical supply and remove the top panel.
2. Release the tub springs and slide the water valve assembly back.
3. Remove the (4) screws, two on each end, and the (2) screws holding the detergent dispenser housing to the brace.

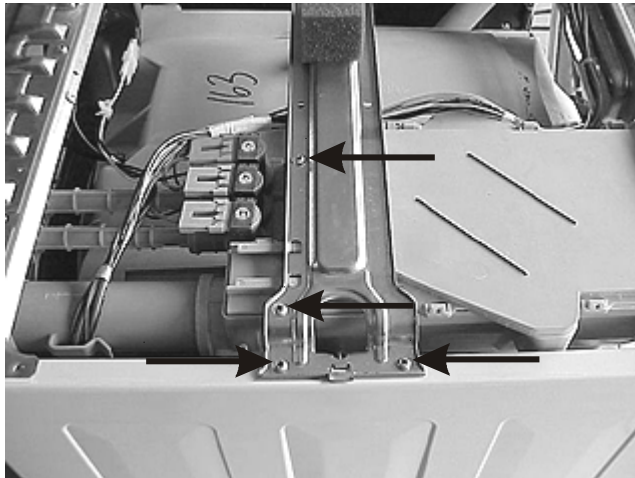

4. Raise the brace to disengage the tabs on the brace from the side panels and slide the brace backward to release the tabs on the brace from the slot in the detergent dispenser housing.

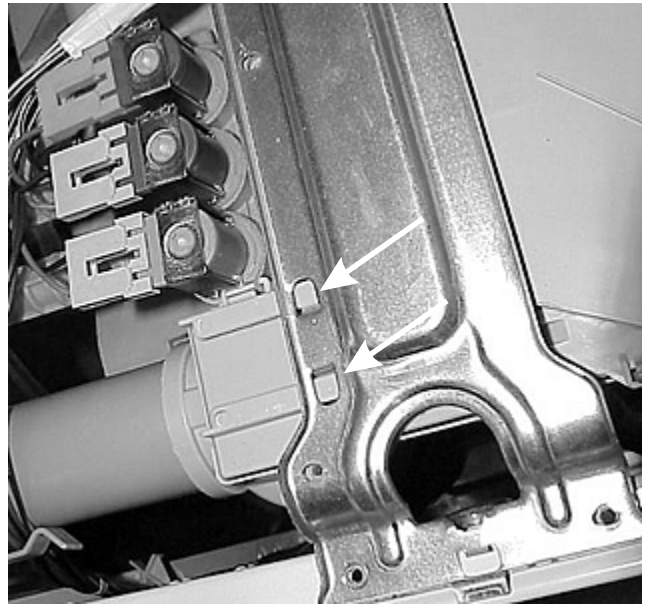

Removing the detergent cavity assembly:

1. Disconnect the washer from the electrical supply, remove the drawer and the top panel.
2. Disconnect the water valve assembly and the overflow/vent tube and slide them back.
3. Release the wiring harness from the side of the housing.
4. Disconnect the detergent dispenser outlet hose.

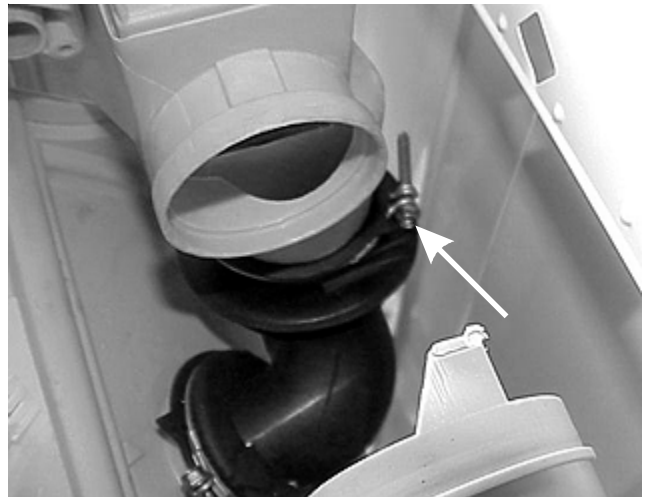

5. Remove the (2) screws holding the housing to the center bar.

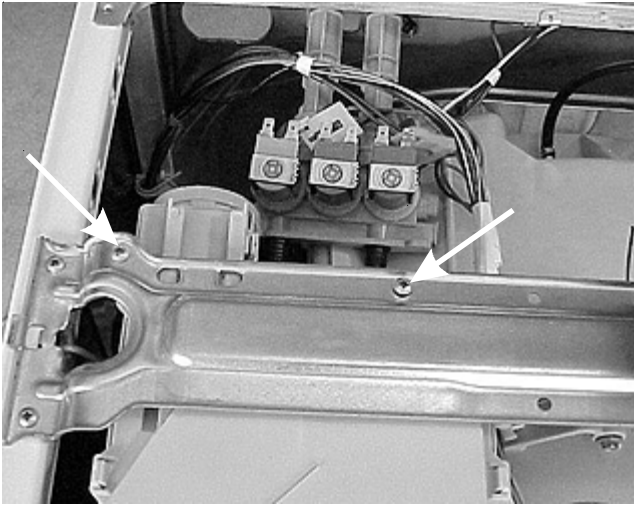

8. Slide the housing back until the tabs of the center cross bar release and the housing drops down.

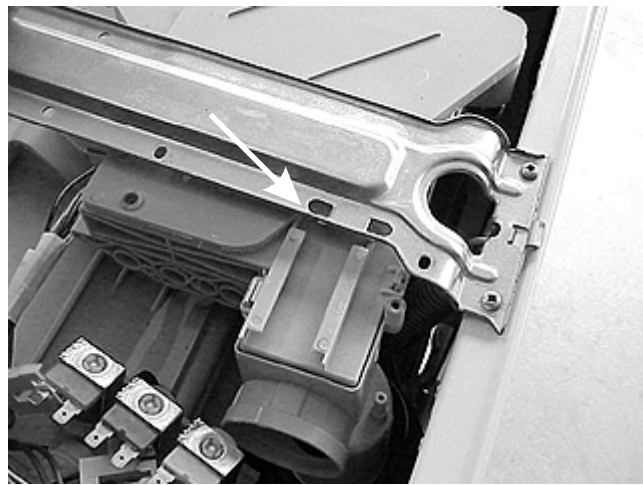

6. Remove the (2) screws holding the housing to the console panel.

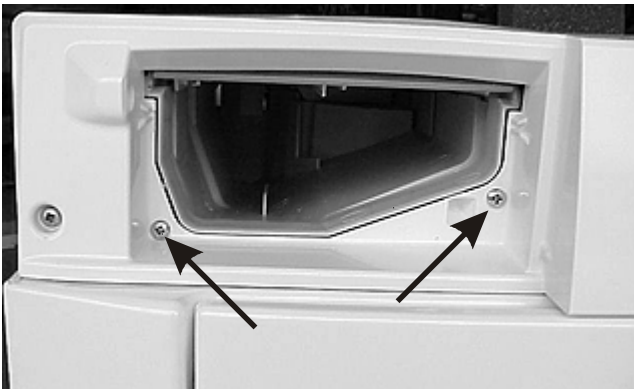

9. Disconnect the advanced rinsing technology hose.



7. Release the (2) tabs, one on each side, locking the housing to the console mounting panel.



10. Push down on the tub and swing the front of the housing toward the center of the washer. Work the housing out from under the center brace and lift the housing out.

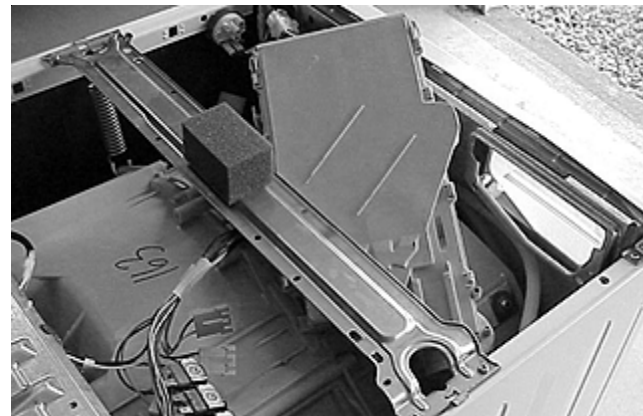

Removing the detergent dispenser outlet hose:

1. Disconnect the washer from the electrical supply and remove the top panel.
2. Release the overflow/vent tube and slide it back.
3. Loosen the (2) clamps, one on each end, and slide the hose off.



2. Loosen the clamp at the tub.

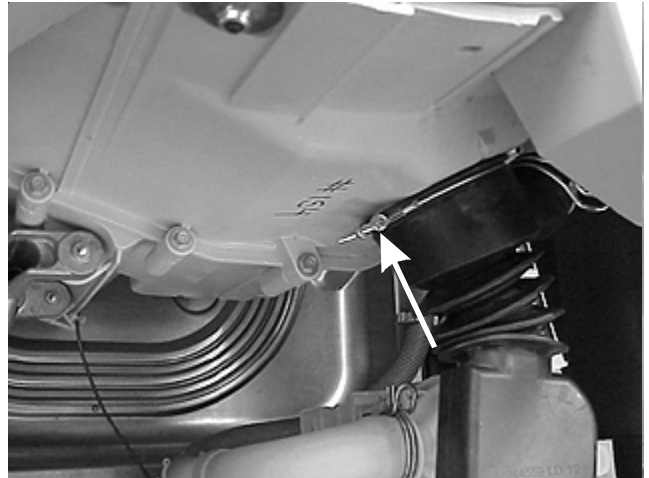

3. Release the clamp at the pump.

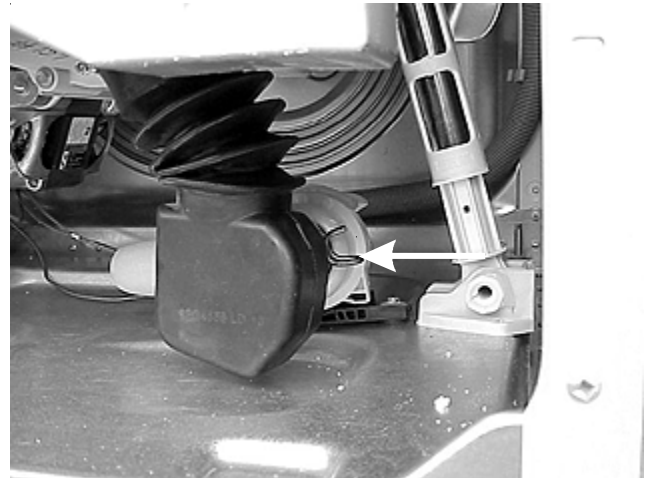

Removing the siphon break hose:

1. Disconnect the washer from the electrical supply and remove the top panel.
2. Release the (2) clamps, one on each end, and slide the hose off.



4. Slide the hose off the tub and pump to remove the sump.

Removing the hose between the drain pump and the drain hose coupler:

1. Disconnect the washer from the electrical supply, remove the top panel and the front access panel.

Removing the drain sump:

1. Disconnect the washer from the electrical supply and remove the front access panel.

Note: There will be water in the pump and hose.

2. Release the clamp and slide the hose off the drain pump.

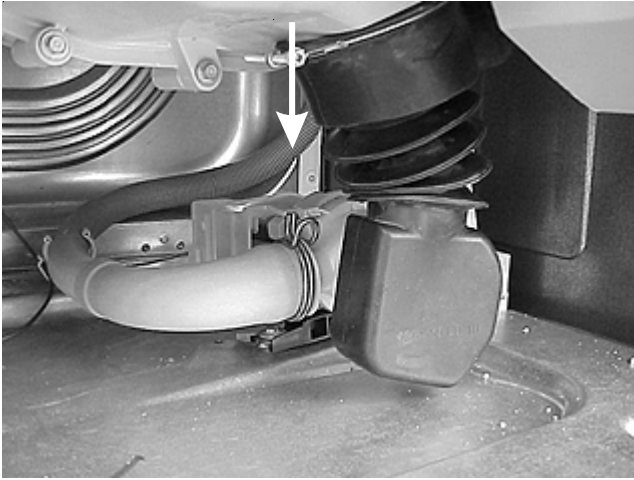

3. Release the and slide the hose off the drain hose coupler.



5. Release the hose from it guides and pull the hose out.

Removing the external drain hose:

1. Release the clamp and pull the hose off the coupler.

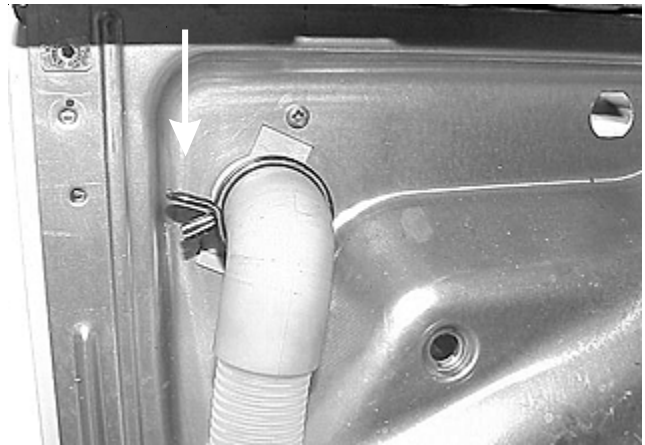

Removing the drain hose coupler:

1. Disconnect the washer from the electrical supply and remove the top panel.
2. Disconnect the (2) drain hoses and the siphon break hose.
3. Remove the screw holding the coupler to the rear panel.



Removing the rear access panel:

1. Disconnect the washer from the electrical supply.
2. Remove the (6) screws holding the rear access panel to the washer's rear panel and lift the access panel off.



Drive belt:

The drive belt (6 rib flat Poly-V) is used to transmit power from the motor pulley to the tub. The belt is constructed of a material that stretches which makes belt tension adjustments unnecessary.

Removing or replace the drive belt:

1. Disconnect the washer from the electrical supply and

- remove the rear access panel.
2. Remove the belt by turning tub drive pulley and rolling belt off pulley. The belt is elastic and is designed to "give" enough to remove and install in this manner.

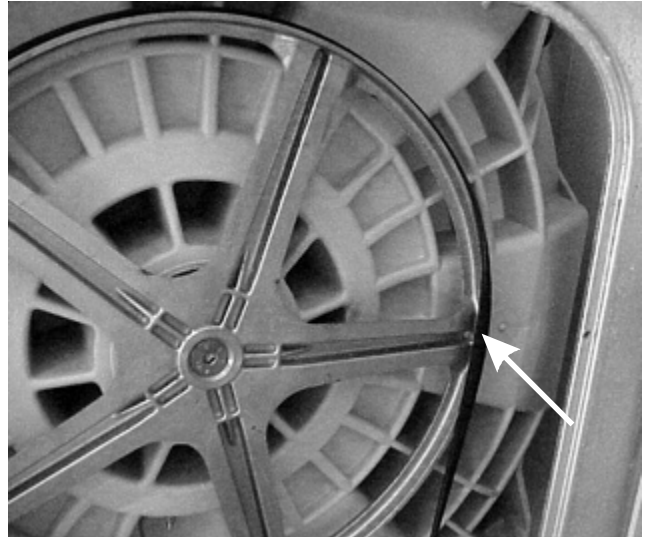

Removing the large pulley:

1. Disconnect the washer from the electrical supply.
2. Remove the rear access panel and the belt.
3. Using a #6 mm Allen wrench remove the bolt in the center of the pulley by holding the pulley and turning the bolt counter clockwise.

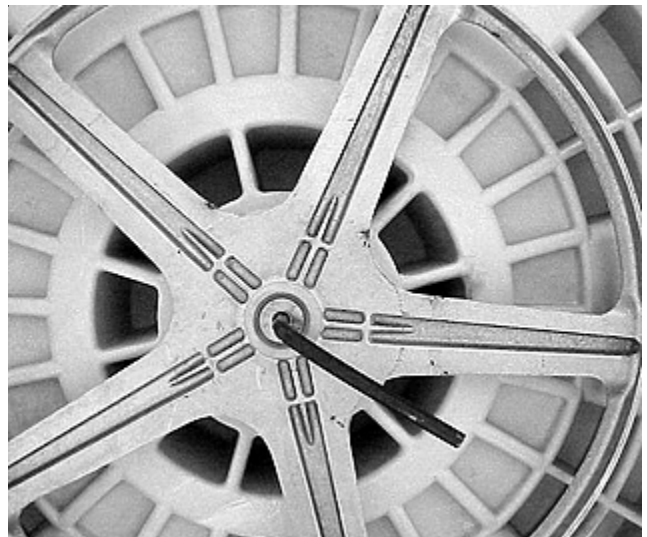

4. Work the pulley back and forth to remove it from the shaft.

Removing the drive motor:

1. Disconnect the washer from the electrical supply and remove the rear access panel and the belt.
2. Unplug the electrical plug and the ground wire from the motor.

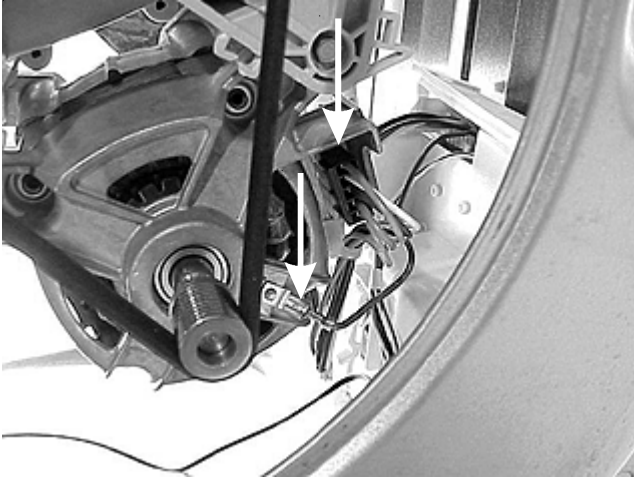

3. Using a 5/16" socket remove the (4) bolts, two in the front and two in the rear, that hold the motor to the outer tub.

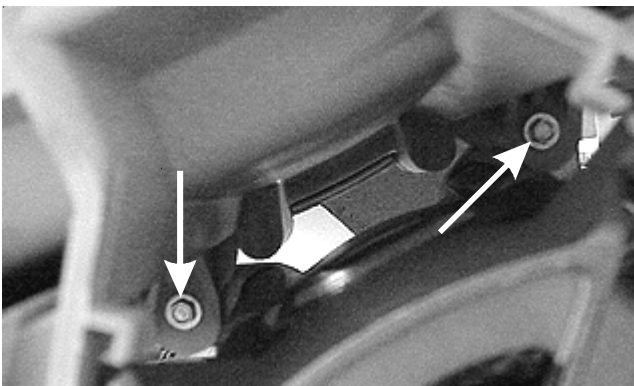
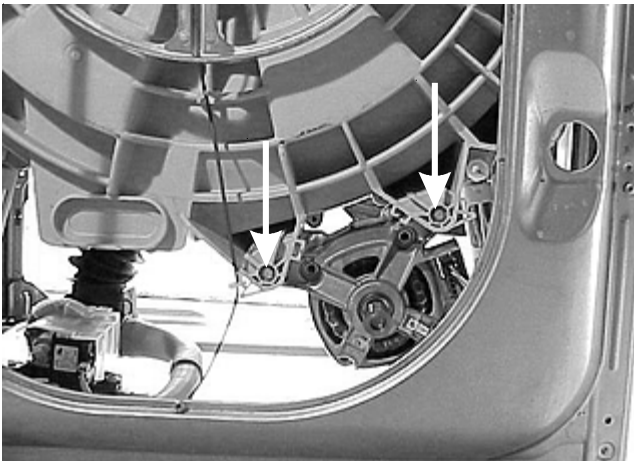

4. Slide motor forward while supporting to remove.



5. Reverse procedure to reinstall, making sure that belt tracks in the center of the large pulley. Adjust by moving belt on motor pulley if required.

Removing the speed control board assembly:

1. Disconnect the washer from the electrical supply and remove the front and rear access panels.
2. Unplug the (2) terminal plug from the lower front.

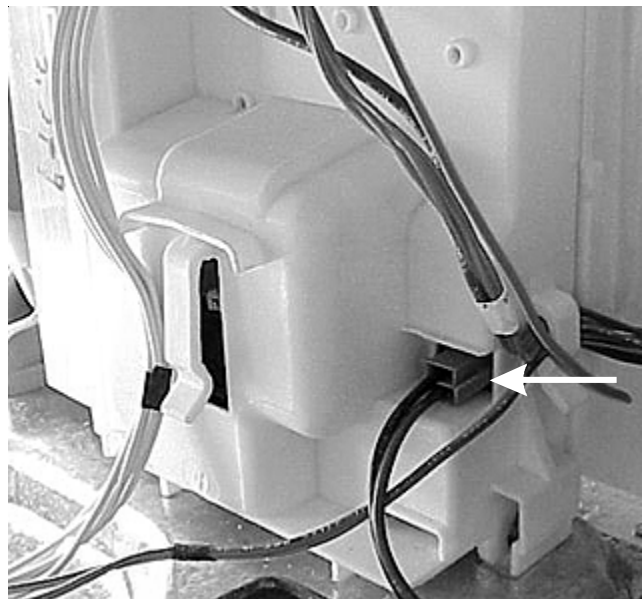

3. Disconnect the wire harness and release the spring loaded locking tab on the side of the control board house. Lift the side of the housing up, slide the assembly to the rear to disengage the front tab and lift the assembly away from the washer base.

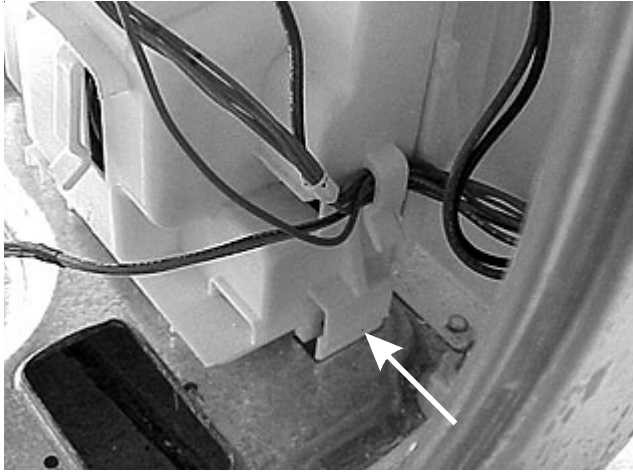

4. From the front of the washer, tip the bottom of the assembly toward the motor and slide the assembly out between the shock absorber and the motor.

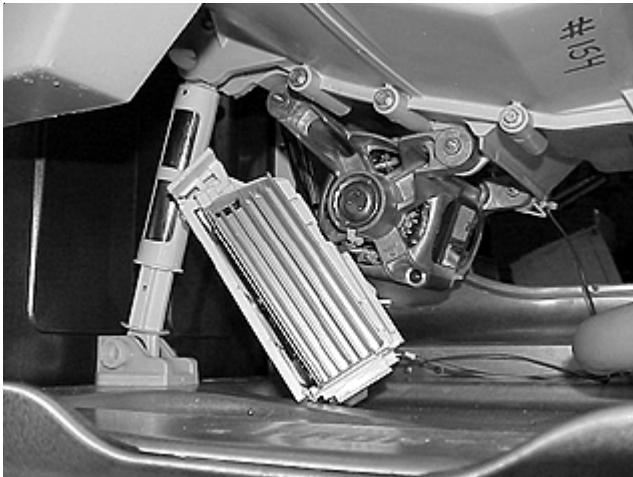

5. Release the latch on each end of the speed control housing and raise the top flap.



6. Unplug the (2) plugs and the ground wire and remove the speed control assembly from the washer.

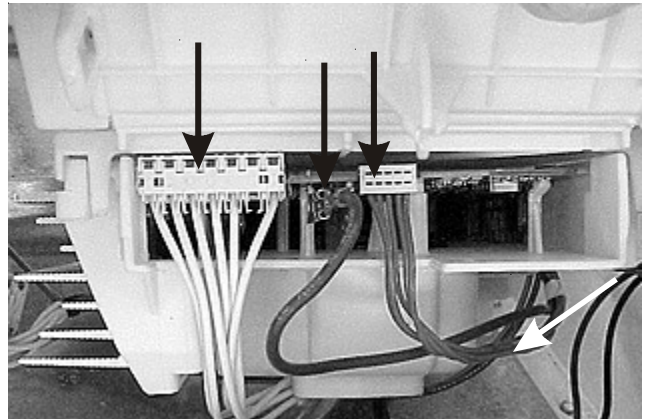

7. To remove the control board from the housing, release the latch on each end at the top and lift the back open.

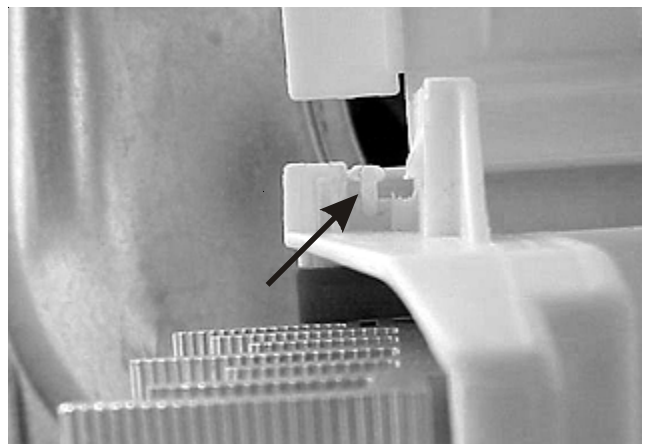

- Lift the control board out.

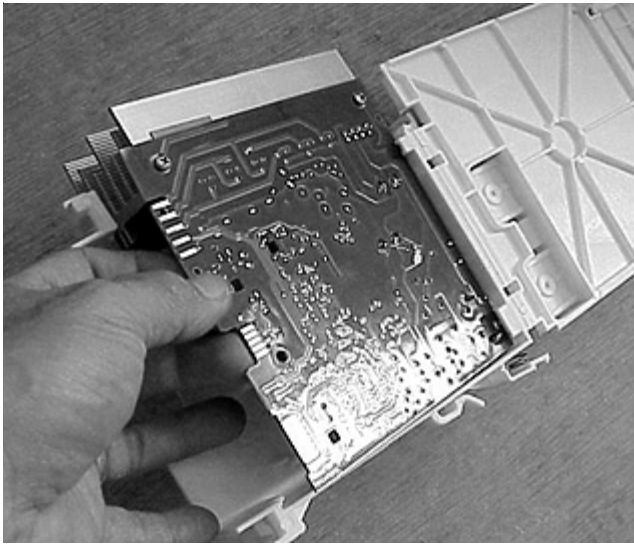

This procedure is much easier if a deep 1/2", 6 point socket (or 13 millimeter, 6 point) is used to compress the locking tab of the plastic pin. Push the socket onto the tapered end of the pin as far as it will go to compress the locking tab.



Removing the right hand shock absorber:

- Disconnect the washer from electrical supply.
- Remove the front access panel.
- Remove air shock securement pins by depressing locking tab while pulling pin to remove.

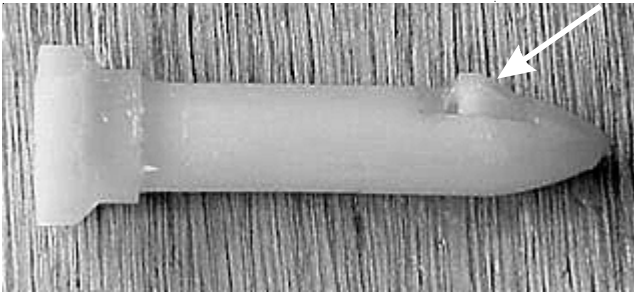

- Use pliers to grasp head of pin and pull to remove. As the pin is removed, the socket will drop free.
- When replacing the air shock, make sure to position it with the bell end facing downward.
- Lubricate the securement pins with Sil-Glide® before installing.

Removing the left hand shock absorber:

- Disconnect the washer from electrical supply.
- Remove the front and rear access panels.
- Remove the speed control board assembly.

- Remove air shock securement pins by depressing locking tab while pulling pin to remove.

This procedure is much easier if a deep 1/2", 6 point socket (or 13 millimeter, 6 point) is used to compress the locking tab of the plastic pin. Push the socket onto the tapered end of the pin as far as it will go to compress the locking tab.

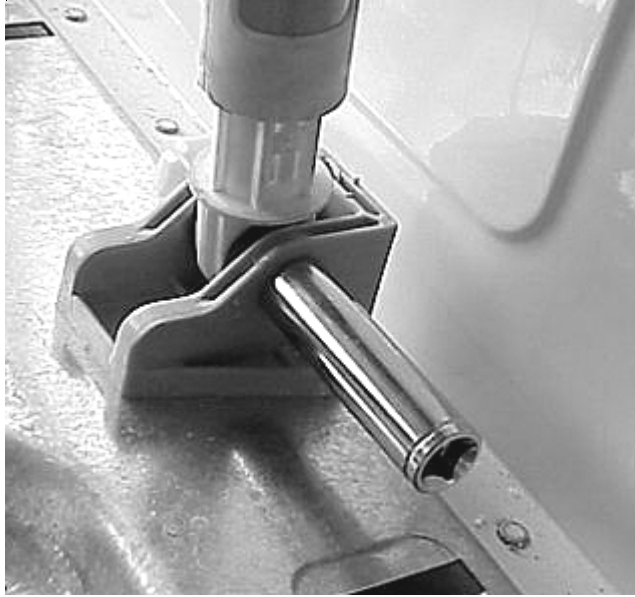

- Remove the (2) hoses, one from each end.

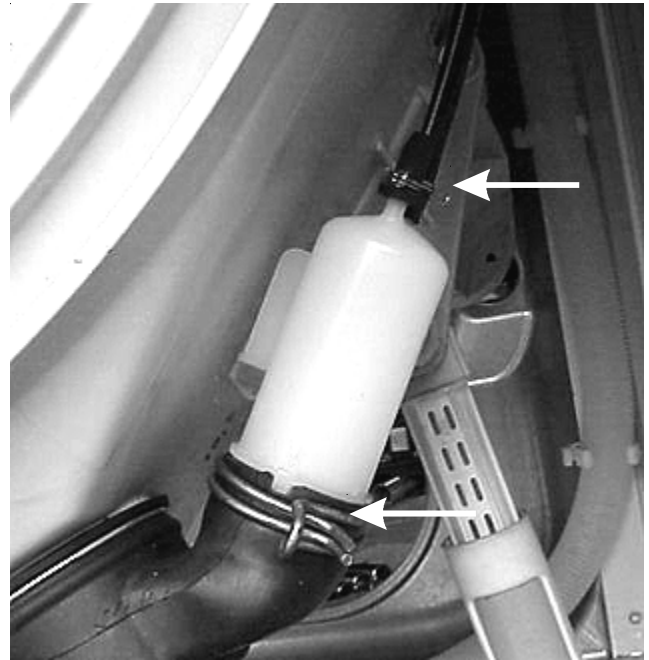

- Use pliers to grasp head of pin and pull to remove. As the pin is removed the socket will drop free.
- When replacing the air shock make sure to position it with the bell end facing downward.
- Lubricate the securement pins with Sil-Glide® before installing.

Removing the air bell:

- Disconnect the washer from the electrical supply and remove the front access panel.

- Release the rivet holding the air bell to the outer tub.

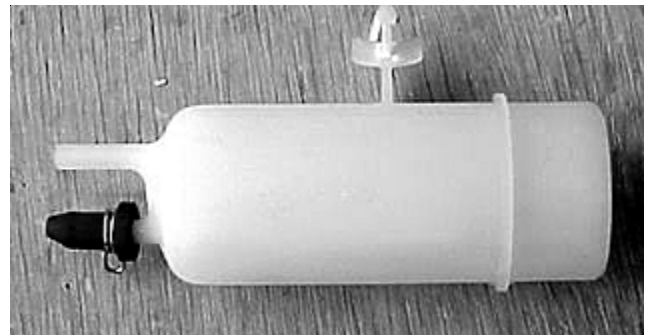

NOTE: Seal air connecting tube to air bell and air bell to sump hose using waterproof glue. **DO NOT** plug air connecting tube opening.

Removing the tub assembly:

- Disconnect the washer from the electrical supply and the hot and cold water hoses.
- Remove the top panel, console, front and rear access panels and the front panel.
- Disconnect the advance rinsing technology hose from the bellows, the detergent outlet and siphon break hoses from the outer tub.
- Remove the drain pump and disconnect the drain sump from the tub.

5. If you are going to replace the front half of the outer tub, remove the bellows and the weight ring.
6. Remove the small hose from the air bell.
7. Remove the large pulley, drive motor and speed control board assembly.
8. Disconnect the bearing ground wire.

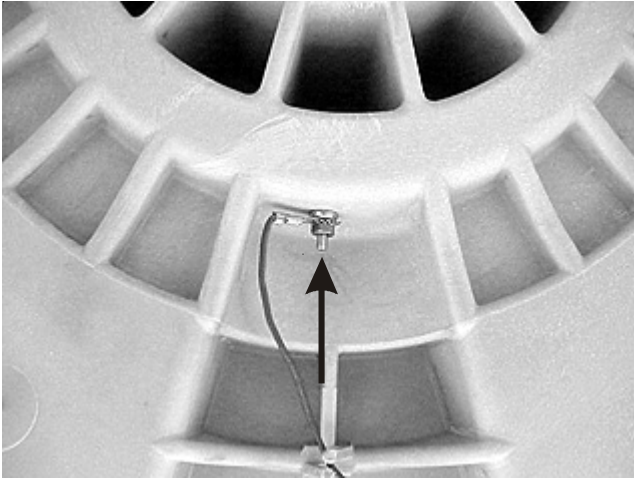

9. Remove the top pins from shock absorbers and push the shock absorbers against the cabinet.



10. Place something down to protect the floor, carefully turn the washer on it's face and release the springs.

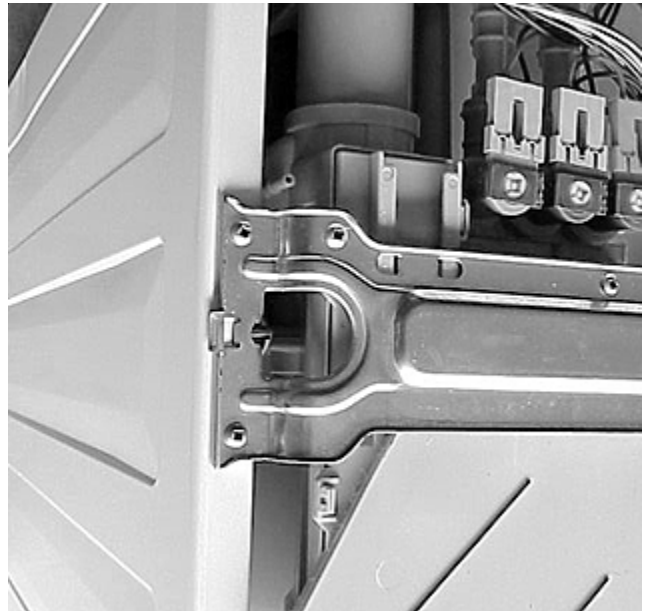

11. Lift the cabinet off of the tub.

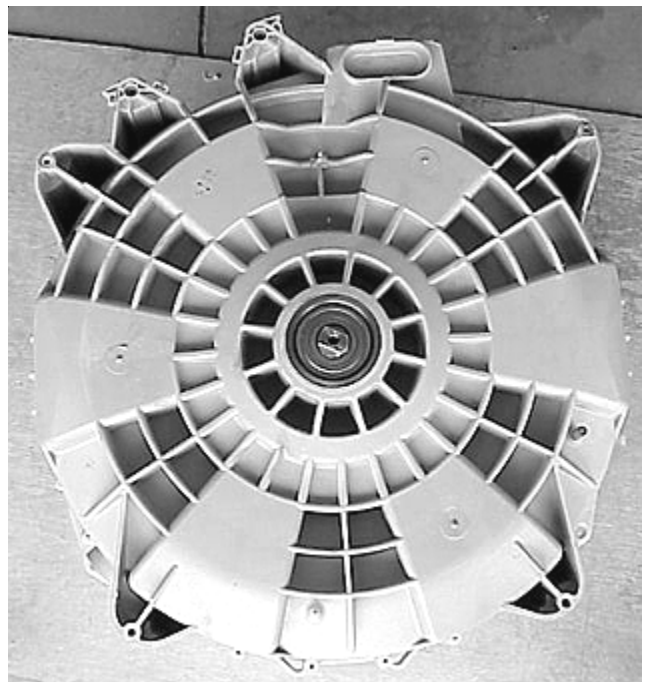

12. Turn the tub over and remove the (23) screws holding the two halves of the tub together.

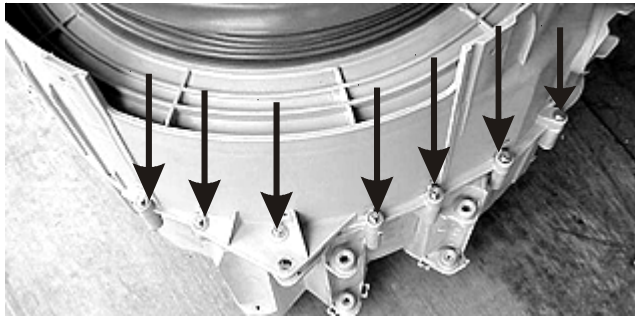

13. Lift the front half of the tub off the assembly.



14. Reverse procedure to reassemble using illustration below to show outer tub screw tightening sequence.

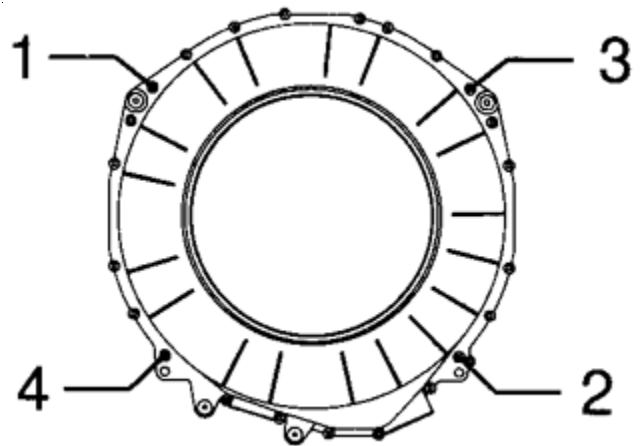

15. The seal between the (2) tub halves is placed in the groove of the rear half and can be lifted out.



16. To remove the spin basket, set the back half of the outer tub on it's side, and reinstall the screw that secured the large pulley to the shaft. Tap the inner tub out with a rubber hammer.



CAUTION: Use caution in handling the spin basket. The outer surface is very sharp!

Note: The bearings, water seal and gasket between the two tubs come as part of the rear half of the outer tub. If the water seal or bearings fail, inspect and if necessary, dress shaft of the spin basket with a file. With some failures it will be necessary to replace the spin basket.



Each vane is locked in place by (4) tabs press out of the spin basket.



Removing the spin basket vanes:

1. Open the washer's loading door.
2. Insert a small shaft common screwdriver into the hole in top of the vane behind the divided space and push the (4) locking tabs open.

Spin basket vanes:

There are three plastic vanes mounted to the spin basket to aid in the washing action during the wash cycle. Each vane has (6) tabs that slide into (6) slots in the spin basket.

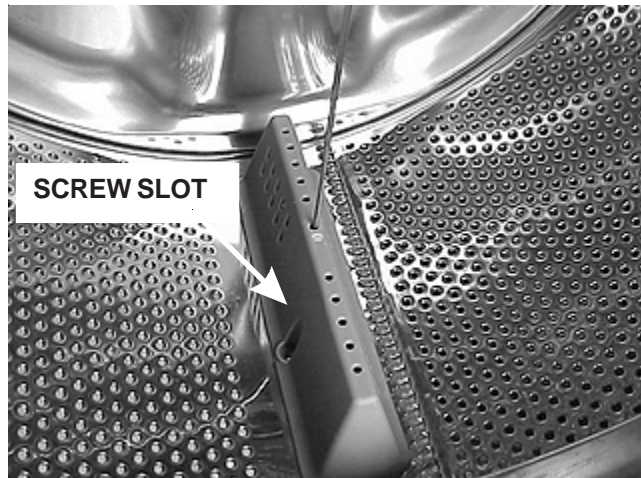
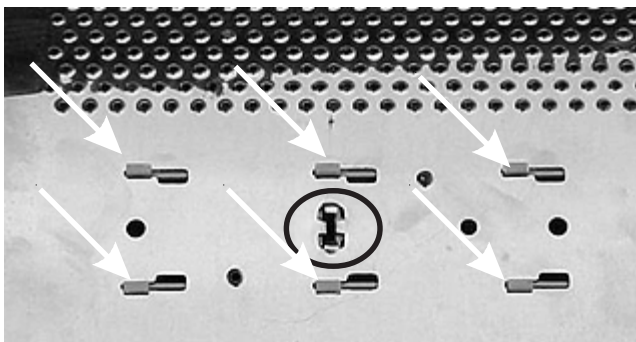

3. Slide the vane toward the door opening to release the (6) tabs and push on the side of the vane to remove.
4. When replace or reinstalling, lock the vane in place with a stainless steel screw through the slot in the side of the vane.

