



DishDrawer

MODELS

DD603	DD603H
DD603I	DD603IH
DS603	DS603H
DS603 I	DS603IH
DD603M	DD603HM
DS603M	DD603HM



Reprinted: 12 August 2002

Fisher & Paykel Ltd
Whiteware Spare Parts
PO Box 58-732, Greenmount
80 Springs Rd, East Tamaki
New Zealand
Tel: (09) 272 0261
Fax: (09) 272 0219
Email: parts@fp.co.nz

COPYRIGHT © FISHER & PAYKEL LTD 2002

CONTENTS

1.0	SERVICE REQUIREMENTS	6
1.1	HEALTH & SAFETY	6
1.1.1	ELECTRICAL SAFETY	6
1.1.2	ELECTROSTATIC DISCHARGE	6
1.1.3	GOOD WORKING PRACTICES	6
1.1.4	ISOLATE WATER SUPPLY	6
1.1.5	WATER LEAK CHECK	6
1.1.6	INSULATION TEST	7
1.1.7	SOLVENT AND EXCESSIVE HEAT DAMAGE	7
1.1.8	SHEET METAL EDGES	7
1.1.9	DIAGNOSTICS	7
1.2	SPECIALISED TOOLS	7
1.2.1	STATIC STRAP	7
1.2.2	FISHER & PAYKEL SMART TOOL	7
2.0	DIMENSIONS & SPECIFICATIONS	8
2.1	DIMENSIONS	8
2.2	SPECIFICATIONS	8
2.2.1	ELECTRICAL	8
2.2.2	COMPONENTS	8
3.0	TECHNICAL OVERVIEW	10
3.1	CHASSIS	10
3.2	DRAWER FRONTS	10
3.3	ELECTRONICS	10
3.3.1	TUB HOME SENSOR	11
3.3.2	TOUCH SWITCHES	11
3.4	MOTOR	11
3.4.1	ROTOR	11
3.4.2	SPRAY ARM	11
3.5	WIRING COVER	11
3.6	LID SYSTEM	12
3.6.1	LID OPERATION	12
3.6.2	WHEN ACTIVATED	12
3.6.3	DURING A POWER FAILURE	12
3.7	TUB	12
3.8	FILLING	12
3.8.1	WATER INLET	12
3.8.2	DISPENSING DETERGENT	13
3.8.3	AMOUNT OF WATER	13
3.9	HEATING	13
3.9.1	THE ELEMENT	13
3.9.2	HEATING THE WATER	13
3.9.3	MAINTAINING THE TEMPERATURE	13
3.9.4	OVERHEAT PROTECTION	14

3.10	LOCKRING NUT.....	14
3.11	DRAIN CYCLE.....	14
3.12	FILTER PLATE.....	14
3.12.1	THE FILTER SYSTEM	14
3.12.2	REMOVING AND CLEANING THE FILTER PLATE.....	14
3.13	DRYING CYCLE	15
3.14	WATER SOFTENER.....	15
4.0	<u>OPTION ADJUSTMENT MODE</u>	<u>17</u>
4.1	HOW TO CHANGE SETUP OPTIONS.....	17
4.1.1	RINSE AID / AUTO POWER / END OF CYCLE BEEPS / CLOSED DRAWER OPTION/WATER SUPPLY HARDNESS/CLEAN/DIRTY DISH SYMBOL	17
4.1.2	RINSE AID SETUP (RA).....	17
4.1.3	AUTO POWER OPTION (AP).....	18
4.1.4	END OF CYCLE BEEPS (EC).....	18
4.1.5	CLOSED DRAWER OPTION (LD).....	18
4.1.6	CLEAN/DIRTY DISH SYMBOL (DS).....	18
4.1.7	WATER SUPPLY HARDNESS SETUP (HD)	18
4.1.8	OPTION ADJUSTMENT QUICK REFERENCE CHARTS.....	19
5.0	<u>DIAGNOSTICS.....</u>	<u>21</u>
5.1	DISHDRAWER DIAGNOSTICS	21
5.1.1	DISPLAY / DOWNLOAD MODE.....	21
5.1.2	OPTICAL LED DOWNLOAD / FAULT DISPLAY	21
5.1.3	CLEARING FAULT LOGS	21
5.1.4	HARDWARE OUTPUT DIAGNOSTIC TEST MODE.....	21
5.1.5	FAST TEST CYCLE.....	22
5.1.6	CONTINUOUS CYCLE TEST MODE.....	23
5.1.7	TEMPERATURE & VOLTAGE DISPLAY MODE	23
5.1.8	SHOW OFF / SHOWROOM WASH MODE	23
6.0	<u>DIAGNOSTICS QUICK REFERENCE CHARTS</u>	<u>25</u>
6.1	FAULT DISPLAY/DOWNLOAD MODE:-.....	25
6.2	HARDWARE OUTPUT TEST MODE:-.....	25
6.3	FAST TEST CYCLE:-.....	25
6.4	CONTINUOUS CYCLE:-.....	26
6.5	TEMPERATURE & VOLTAGE DISPLAY MODE:-.....	26
7.0	<u>FAULT CODES</u>	<u>27</u>
7.1	FAULT CODE DESCRIPTION CHART.....	28
7.2	FAULT CODE PROBLEM SOLVING CHARTS.....	29
7.3	POOR DRY PERFORMANCE.....	33
7.4	POOR WASH PERFORMANCE.....	34
8.0	<u>WIRING DIAGRAM.....</u>	<u>37</u>

9.0	SERVICE PROCEDURES.....	38
9.1	DRAWER FRONT REMOVAL.....	38
9.2	TUB REMOVAL.....	38
9.3	DRAWER AND LCD DISPLAY REMOVAL	39
9.4	DRYING FAN REMOVAL	39
9.5	DETERGENT DISPENSER.....	40
9.6	ELECTRONIC CONTROLLER	40
9.7	FILTER PLATE REMOVAL	41
9.8	ROTOR ASSEMBLY REMOVAL.....	41
9.9	WIRING COVER REMOVAL.....	41
9.10	TUB DISCONNECTION	42
9.11	ROTOR SENSOR REMOVAL.....	42
9.12	LOCKING RING, ELEMENT PLATE AND MOTOR ASSEMBLY REMOVAL	43
9.13	LID REMOVAL.....	44
9.14	YOKE REMOVAL.....	44
9.15	LID ACTUATOR REMOVAL.....	45
9.16	SLIDE RAIL REPLACEMENT.....	46
9.17	CHASSIS CIRCUIT BOARD / FLOOD SENSOR REMOVAL	46
9.18	WATER VALVE REMOVAL.....	47
9.19	FILL HOSE, DRAIN HOSE, WIRING HARNESS REPLACEMENT.....	47
9.20	TOE KICK REMOVAL.....	48
9.21	LOWER TUB COWLING.....	48
9.22	FRONT TRIM REPLACEMENT	48
9.23	WATER SOFTENER.....	49

1.0 SERVICE REQUIREMENTS

1.1 Health & Safety

Note: When servicing the DishDrawer, Health and Safety issues must be considered at all times. Specific safety issues are listed below with their appropriate icon. These are illustrated throughout the service information to remind service people of the Health and Safety issues.

1.1.1 Electrical Safety



Ensure the mains power has been disconnected before servicing the DishDrawer. If the mains supply is required to be on to service the DishDrawer, make sure it is turned off when removing any electrical component or connection to avoid electrical shock.

1.1.2 Electrostatic Discharge



An anti-static strap is to be used as electrical static discharge (ESD) protection when servicing electronic components.

1.1.3 Good Working Practices



Ensure the work area is in a tidy and orderly condition at all times so as not to cause a hazard while service work is being completed. Always clean and tidy the DishDrawer and work area after service is completed.

1.1.4 Isolate Water Supply



Turn off the water connection tap before servicing.

1.1.5 Water Leak Check

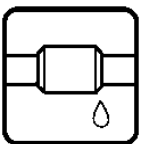

Check for water leaks as part of the testing after the service has been completed.

1.1.6 Insulation Test



Megger test to check insulation.

Warning: Short together the phase and neutral pins on the plug so as not to damage any electronic circuitry.

1.1.7 Solvent and Excessive Heat Damage



Plastic surfaces can be damaged by solvents and excessive heat.

1.1.8 Sheet Metal Edges



When working around cut sheet metal edges use appropriate gloves or protection to eliminate the chance of receiving a laceration.

1.1.9 Diagnostics



While in diagnostics some safety devices are bypassed. Ensure you do not run components unattended. They may overheat, flood, burnout or cause water damage.

1.2 Specialised Tools

For servicing this product Specialised tools are required.

1.2.1 Static Strap:

To be used as ESD protection when replacing or handling electronic components.

1.2.2 Fisher & Paykel Smart Tool

Handheld palm computer supplied in protective case with F&P diagnostics software and service information loaded:

P/N 813141 (includes light pen P/N 425930).

2.0 DIMENSIONS & SPECIFICATIONS

2.1 Dimensions

	Product Size (mm)	Product Size (inches)	Minimum Cavity Size	Minimum Cavity Size
Height (double)	819.4-869.4mm	32 ¼ inch – 34 ¼ inch	820-870mm	32 ⁵ / ₁₆ inch
Height (single)	408.9mm	16 inch	410mm	16 ¹ / ₈ inch
Width	595mm	23 ⁷ / ₁₆ inch	600mm	23 ⁵ / ₈ inch
Depth	570mm	22 ⁷ / ₁₆ inch	580mm	22 ⁷ / ₈ inch
Drawer Open (inc cab)	1080mm	42 ½ inch		

2.2 Specifications

2.2.1 Electrical

Market	Voltage	Frequency	Current
NZ/AUS/UK/EU	230-240 V AC	50 Hz	10 A max
USA	110-120 V AC	60 Hz	12.5 A max
JAP	90-110 V AC	50/60 Hz	11.6 A max

2.2.2 Components

Component	Part Number	Specifications
Water Inlet Valve	P/N 526850 Double 2.5litre P/N 526851 Single 2.5 litre P/N 525113 Double 5 litre P/N 526851 Single 5 litre	24V DC 70+/- 5 Ohms per coil 2.5Lt/min (0.65 US gal/min) 5 litre/min (1.3 US gal/min)
Dispenser	P/N 526860	24V DC per coil 70+/- 5 Ohms per coil
Rinse Aid capacity		50mls (approx. 25 washes)
Chassis PCB (NZ/AUS/UK/EU)	P/N 525958P	240V AC
Chassis PCB (USA/JAP)	P/N 525959P	120V AC
Motor Drain Direction Wash Direction		80V DC 3 Phase 4200RPM 2300-2850RPM
Stator	P/N 526530	8.0 +/- 5 Ohms (per winding)

Component	Part Number	Specifications
Heater Plate (NZ/AUS/UK/EU) Heater Track Power Supply Resistor	P/N 526443	240V AC 60 Ohms +/- 3 Ohms 125 Ohms +/- 5 Ohms
Heater Plate (USA) Heater Track Power Supply Resistor	P/N 526444	120V AC 26 Ohms +/- 2.5 Ohms 30 Ohms +/- 5 Ohms 650 Watts
Heater Plate (JAP) Heater Track Power Supply Resistor	P/N 526820	110V AC 20 Ohms +/- 1.5 Ohms 20 Ohms +/- 2 Ohms
Temperature Sensor	On Heater Plate	962 Ohms @ 20 ⁰ C (68 ⁰ F) 1000 Ohms @ 30 ⁰ C (86 ⁰ F) 1202Ohms @ 60 ⁰ C (140 ⁰ F)
Inlet Hose Inlet Hose (USA) Inlet Hose (JAP)	P/N 521349 P/N 525970 P/N 526809	1.7m (66 inches) 1000Kpa / 145 P.S.I.
Drain Hose Drain Hose (Lower) Drain Hose (Upper)	P/N 525966 P/N 525967	2.0m (78 inches) from rear of cabinet 2.5m (98 inches) bottom tub 2.9m (14 inches) top tub
Drying Fan	P/N 526265	3.4K Ohms
Diverter Valve Softener Assy	P/N 526416	24V DC Coil 70 +/- 5 Ohms Coil
Brine Pump Assy	P/N 526418	24V DC Coil 70 +/- 5 Ohms Coil
Water Softener		500 grams Salt Capacity approx 14 regenerations 290+/- 10ml Resin

3.0 TECHNICAL OVERVIEW

3.1 Chassis

The DishDrawer chassis is one complete assembly composed of 5 steel metal components locked together by a proprietary riveting process. The chassis exterior is made of a lacquered electrogalvanised material called Galvoclean.

Unlike most other dishwashers, the chassis assembly is a load carrying structure designed to impart stiffness to the product and to ensure deflection is minimised.

The feet of the cabinet are assembled into the chassis by means of four steel inserts which are clinched in place to form a permanent threaded connection.

The tub extends 520mm (20¹⁵/₃₂"') out of the cabinet by travelling along two rigidly attached slides on either side of the tub.

3.2 Drawer Fronts

Prefinished drawer fronts are formed from a prepainted or brushed stainless steel blank. The drawer fronts are attached to the tub by means of formed hooks and two pins which are inserted through either side of the tub.

On the integrated model, the front panel supplied on each drawer is the mounting panel for the joinery finished drawer front. The joinery finished drawer front is supplied by the customer.

3.3 Electronics

In the DD603/ DS603 (Phase 3) electronic controller the functions of controlling the motor as well as controlling the user interface console have been combined into a single 16-bit Micro Controller on the main printed circuit board.

This Micro controller also controls a transformerless 85w *switchmode power supply*. This power supply utilises a large dropping resistor on the heater plate in conjunction with phase control of the mains voltage in order to produce a variable voltage rail. From this the controller can supply voltages from 5V to 85V to the various components in the DishDrawer.

NOTE:- With power supplies of this nature all components regardless of supply voltage should be treated as live to earth.

The user interface comprises a printed circuit board for front controls and a touch switch panel for internal controls.

The electronics can connect to a computer service tool via an optical light pen for fault finding and product information.

The element is switched by one single pole relay. Overheat protection is effected by a short length of solder in series with the dropper resistor track on the heater plate. In an overheat situation this solder melts causing the power supply to go open circuit.

3.3.1 Tub Home Sensor

A tub home sensor is used to determine when the tub is closed and it is safe to start a cycle. The tub home sensor consists of an inferred LED (sender) and an inferred transistor (receiver) mounted on the circuit board in the controller. Inferred light is transmitted from the LED down an optical light pipe to the side of the tub. The inferred receiving transistor also has an optical light pipe leading from it out to the side of the tub. When the tub is closed the two light pipes are optically connected via a prism mounted in the side of the chassis.

3.3.2 Touch Switches

Two touch switches are used on the secondary control panel one to select the required wash cycle and one to turn the Eco option on or off. They are capacitive touch switches and are supplied with an analogue signal from the controller that will change in the presence of an earthed mass (i.e. customer's finger).

3.4 Motor

The motor is a fully electronically controlled 80V 60w 3 phase 6 pole brushless DC motor, running on wash at between 2300-2850rpm depending on the cycle selected and at approximately 4200 rpm on Drain.

3.4.1 Rotor

The rotor is a four pole permanent magnet rotor with a graphite bearing at each end of the vertical shaft. At the lower end of the rotor shaft is the drain impellor and at the upper end is the wash impellor.

3.4.2 Spray Arm

The spray arm is shaped for most efficient waterflow. The holes are positioned for best penetration into the wash load, with the water jets angled to ensure the spray arm rotates at the most efficient speed. There is a flap valve moulded into the top of the spray arm. This part lets air through the spray arm when the DishDrawer is filling with water. The DishDrawer fill levels are more consistent with the flap valve system.

3.5 Wiring Cover

The wiring cover protects the customer from all electrical components in the motor area underneath the tub. All electrical components regardless of voltage should be treated as live with respect to earth. It also serves to protect the motor assembly, drain and fill hoses from damage when opening and closing drawers. The wiring cover acts as a cosmetic part of the product.

3.6 Lid System

3.6.1 Lid Operation

The lid is a single piece of polymer plastic with a static seal co-injection moulded into it. Each side of the lid is clipped into a yoke which is in turn connected to a worm drive lid actuator assembly containing a small brushed DC 24V motor.

3.6.2 When Activated

At the beginning of each wash cycle, both motors are powered up for approximately 10 seconds which pulls the lid down onto the tub. The lid remains down for the duration of the cycle and is only lifted when the DishDrawer beeps to signal the end of the cycle or if the customer pauses it to gain access to the tub.

3.6.3 During a Power Failure

If power to the DishDrawer fails with the lid down you can still force the tub open manually if access is required. It is very difficult however to close the tub again without lifting the lid. The lid can be wound up manually with the tub fully removed.

3.7 Tub

The tub is the main cavity where all the wash activity occurs. The tub is a polymer plastic receptacle which has a wash pump and spray arm at the base. The tub also has guide vanes around its walls which direct falling water from the wash cycle in a clockwise direction around the filter plate. This clears the filter plate of food particles into the sump where they can be trapped or pumped out during the drain cycle.

3.8 Filling

3.8.1 Water Inlet

The tub of the DishDrawer fills by a single water inlet hose, hot water connection for USA and Japanese products and cold water connection recommended for the Australasian/UK/ Europe products. From the connection to the water supply in the kitchen, the inlet hose enters the cabinet of the dishwasher at the base, onto a dual water valve. Each tub is supplied water independently via one of the dual valve coils and a fill hose that runs through a customised link assembly at the back of each tub and travels along the base of the tub under the wiring cover to the front. At the front of the tub, the fill hose connects to the detergent dispenser which allows water to enter the tub, firstly through the pre rinse section of the dispenser for the pre rinse cycle and secondly through the main wash section for all other cycles.

3.8.2 Dispensing Detergent

The dispenser is mounted in the front wall of the wash tub.

The detergent dispenser consists of two detergent chambers, one for pre wash and the other for the main wash.

The detergent dispenser door is opened manually for detergent loading and then manually closed ready for the detergent to be transported to the wash tub by the inlet water. To enable each detergent chamber to be dispensed separately, an inlet water diverter valve controlled by the electronics is required.

Additionally a positive displacement pump unit and storage tank are incorporated within the dispenser to supply rinse aid. The rinse aid dispensed volume can be adjusted by the customer utilising the DishDrawer's electronic controller. A glowing red light on the tank filler cap indicates an empty rinse aid tank.

3.8.3 Amount of Water

The tub fills with approximately 2.5 litres / 0.8 US gallons of water, approximately level with the base of the spray arm. Once this level is reached, the wash pump (which has sensed the fill via the electronics) becomes primed and pumps the water through the spray arm which will then rotate. The load on the wash pump is constantly monitored throughout the wash cycle and the water level adjusted if necessary.

3.9 Heating

3.9.1 The Element

The heater plate is an element consisting of a porcelain enameled steel plate with a thick film resistive circuit written onto the dry side. As well as the heating circuit a large dropping resistor is also written onto the heater plate which forms part of the controllers power supply. The element is clamped in place by a lockring nut and supports the motor at the base of the tub.

3.9.2 Heating the Water

The heater plate lies beneath the filter plate. A flow through water heating system is created during the wash cycle by allowing water to flow through the filter plate, over the surface of the element and into the wash pump.

3.9.3 Maintaining the Temperature

Attached to the element is a sub printed circuit board with a temperature sensitive thermistor. This connects by means of a RAST 2.5 connector system to the wiring harness of the element. Sensor components are unserviceable and if they fail a new heater plate is required.

3.9.4 Overheat Protection

The heater plate is only activated during the wash cycles. It is not used for drying. The temperature is maintained by the thermistor. If a failure occurs with the electronic control of the heater plate overheat protection is effected by a thermal fuse on the heater plate itself.

The thermal fuse consists of a short length of solder in series with the dropper resistor track which will melt at a relatively low temperature thus causing the controllers power supply to go open circuit disconnecting power to the element.

3.10 Lockring Nut

The lockring nut holds the heater plate into the base of the tub and motor housing assembly to form a watertight seal. It does this by compressing two large 'O' rings between the heater plate and tub and between the heater plate and the motor assembly.

It has clips which hold the drain hose, fill hoses and the wiring loom in place.

Another function of the lockring nut is to support the wiring cover with three clips.

3.11 Drain Cycle

The drain pump is a self priming centrifugal pump which only pumps when the motor is rotating in the drain direction (anti-clockwise). It has a five bladed impellor pushed into a spline on the end of the rotor shaft.

The drain pump housing, which incorporates an inlet and outlet pipe, is welded to the motor housing, hence captivating the motor.

The inlet pipe plugs straight into the sump and is sealed there by a small 'O' ring.

The outlet pipe has a non return flap valve to prevent soiled water returning to the tub.

The drain hose is an extruded blow mould hose which is routed over the link assembly and exits out of the base of the product and is connected to a domestic drain.

3.12 Filter Plate

The filter plate is a stainless steel disk which lies below the dish rack and spray arm and completely encompasses the base of the tub.

3.12.1 The Filter System

The tub is designed with vanes which swirl the water around and over the filter plate. At the front of the tub, located as part of the filter plate, is the drain filter. Large soils collect in the drain filter and only smaller soils flow through its micro mesh filter, eliminating re-depositing of soil during the wash. The drain filter should be regularly checked and cleaned.

3.12.2 Removing and Cleaning the Filter Plate

The drain filter can be emptied with the dish rack in place by removing the cutlery basket and opening the plastic section of the dish rack. The filter plate is removable for cleaning by removing the dish rack and spray arm and unlocking the locking nut anti-clockwise.

3.13 Drying Cycle

Immediately after water from the final hot rinse has been drained from the tub, the drying system begins operation.

The fan draws air through the tub, where it absorbs water from the dish load. The moisture laden air is then mixed with a larger quantity of ambient air (from the kitchen), to minimise the amount of vapour visible when exiting from the drawer front.

The fan runs continuously during the drying cycle and will restart if the tub is opened and closed again. After the drying cycle is complete, the fan continues to run for 30 minutes, but will not restart if the tub is opened.

3.14 Water Softener (where fitted)

The Water Softener uses a softening material (resin) to prevent most of the elements that cause hard water from being present in the wash water. The resin can treat a limited amount of water before it needs to be regenerated. Regeneration is achieved by pumping salty water through the resin, and flushing away the hard elements to the drain. The process of delivering softened water, and regeneration is controlled by the Electronic Controller.

Delivering Softened Water:- Supply water arrives from the inlet valve. In the water softener it passes through a piper interrupter (air break) and a diverter valve. It is then either directed through the resin to the dispenser and or the tub. The electronic controller measures the volume of water treated, and adds an appropriate amount of non-treated water, to deliver a mix which is at the required hardness according to a pre-determined schedule. Water is treated according to its supply hardness. The customer is able to select one of 5 settings.

Regeneration:- Regeneration is triggered when the amount of water that has been treated since the last regeneration nears the capacity of the Water Softener. The quantities treatable for each of the 5 settings of supply hardness have been predetermined, and are stored in the electronic controller. When triggered, immediately after filling for the main wash, the brine pump is activated and delivers a volume of salty water into the resin, at an amount appropriate to the hardness setting. When the wash cycle finishes, the resin is flushed with supply water, and the by-products of regeneration are delivered into the wash water, and drained with it away to waste. Normal treatment of incoming water then resumes.

Salt:- the customer is required to fill the salt tank with dishwashing salt from time to time. Salt is used by the water softener by mixing it with water to produce the salty water (brine) used in regeneration. When the salt level is low, a salt level detector causes a glowing red light to appear in the salt bung, and a "Salt" symbol appears in the LCD. When this happens, the customer should remove the salt bung, and using the salt container provided, pour salt into the salt reservoir until salt can be seen at the opening. The "Salt" symbol on the LCD will disappear and the red light will not be visible when the salt tank bung is replaced. In areas where the supply water is moderately hard (21 dH – degrees of hardness, 375ppm – parts per million, Water Softener Setting 3) the salt reservoir will need to be filled about once a month, and in harder areas more frequently. Delivery of treated water from one fill of the salt reservoir:

599082

240 litres at 30 – 100 ppm from 375 ppm supply water

144 litres at 30 – 100 ppm from 625 ppm supply water

4.0 OPTION ADJUSTMENT MODE

4.1 How to Change Setup Options

4.1.1 Rinse Aid / Auto Power / End of Cycle Beeps / Closed Drawer Option/Water Supply Hardness/Clean/Dirty Dish Symbol

To enter this setup mode, hold the **Eco** touch switch and **KeyLock** button simultaneously for 5 seconds ensuring that **Eco** is pushed first. Once the setup mode is entered a beep is emitted and the LCD displays the letters rA. By pushing the **Start/Pause** button you can scroll through and change the following options:-

Rinse Aid Setup (rA)

Auto Power Option (AP)

End of Cycle Beeps (EC)

Closed Drawer Option (Ld).

Clean/Dirty Dish Symbol (dS)

Water Supply Hardness Setup (hd)

Integrated:- On an Integrated DishDrawer, where there is no display, you can still tell which option you have chosen by using the lights showing on the integrated badge as follows:-

Rinse Aid Setup (red light above Start/Pause button)

Auto Power Option (orange light above Start/Pause button)

End of Cycle Beeps (green light above Start/Pause and red light above Keylock) button) Closed Drawer Option (red light above Start/Pause and Keylock buttons)

Clean/Dirty Dish Symbol (not available on Integrated models)

Water Supply Hardness (Green light above Start/Pause button)

Push **Power** at any time to exit this setup mode.

4.1.2 Rinse Aid Setup (rA)

The current rinse aid setting is shown using the red LED's on the touch switch panel.

The amount of rinse aid dispensed into a rinse cycle can be varied to suit the level of hardness of the local water supply. It is adjusted for 1 - 5 dispenser levels

(1 = approx 0.5mls ($\frac{1}{10}$) teaspoon of rinse aid, 5 = approx. 2.5mls ($\frac{1}{2}$) teaspoon of rinse aid).

Push **Keylock** to advance the rinse aid setting. Once the desired setting is achieved, push **Power** to exit. The rinse aid index is stored in EE memory, so even with the power removed, the rinse aid level is retained.

Integrated:- On an Integrated DishDrawer when you turn on or turn off one of the following options it is indicated by the red wash cycle LEDs on the secondary control panel. If an option is turned on then all the LEDs turn on and if an option is turned off all the LEDs turn off.

4.1.3 Auto Power Option (AP)

The automatic power up sequence that occurs when the tub is opened can be turned on or off using the **Keylock** button. If the Scrubbing Brush is showing on the LCD then the auto power up sequence will occur when the tub is Opened. If the Scrubbing Brush is not showing then the DishDrawer will not automatically power up when the tub is Opened (the customer will need to push the power button each time they wish to use the DishDrawer). Push **Power** to exit when the desired setting has been selected.

4.1.4 End of Cycle Beeps (EC)

The six beeps that occur at the end of every cycle can be turned on or off using the **Keylock** button. If the Scrubbing Brush is showing on the LCD then the end of cycle beeps are activated. If the Scrubbing Brush is not showing then the end of cycle beeps are deactivated. Push **Power** to exit when the desired setting has been selected.

4.1.5 Closed Drawer Option (Ld)

The Closed Drawer Option can be turned on or off using the **Keylock** button. If the Scrubbing Brush is showing on the LCD then the Closed Drawer Option is selected and it will keep the DishDrawer locked at all times by bringing the lid down. When this mode is selected the customer needs to push the power button to lift the lid whenever they want to open the drawer. When they close the drawer again the lid comes down automatically after 30 seconds and locks the tub. If the Scrubbing Brush is not showing then the Closed Drawer Option is deactivated.

4.1.6 Clean/dirty Dish Symbol (dS) (not available on integrated models)

The Clean/dirty dish symbol can be turned on or off using the **keylock** button. If the Scrubbing Brush is showing on the LCD then the Clean/dirty dish option is selected. This means that the end of cycle clean dishes symbol will remain in the LCD display until the power button is pressed to clear it. If the Scrubbing Brush is not showing then the Clean/dirty dish symbol will disappear when the drawer is first opened at the end of a cycle (factory setting).

4.1.7 Water Supply Hardness Setup (hd)

The current supply hardness setting is shown using the red LED's on the touch switch panel. One of 5 settings should be selected according to the known hardness of the supply water. Each setting is appropriate for the following water supply hardness:

No. LED	Water Softener turned off, continuous bypass of softener
1	150-250 ppm water supply hardness
2	250-350 ppm water supply hardness
3	350-450 ppm water supply hardness
4	450-550 ppm water supply hardness
5	550-625 ppm water supply hardness

Push **Keylock** to advance the Water Softener setting. Once the desired setting has been achieved push **Power** to exit.

Selection of a setting affects how the Electronic Controller diverts supply water, how much water is treated, and how much salt is used in regeneration, in a manner that optimises the performance of the Water Softener.

4.1.8 Option Adjustment Quick Reference Charts

Rinse Aid Setting (rA):-

(alter the amount of rinse aid dispensed)

Press and hold Eco, then Keylock for 5 seconds

rA will be displayed (integrated: Red LED above start/pause button showing)

Press keylock

The rinse aid setting will advance on the secondary control panel LEDs with each press

Press Power

Will exit & save selected setting

Auto Power Option (AP):-

(powers up automatically when the drawer is opened)

Press and hold Eco, then Keylock for 5 seconds

rA will be displayed

Press Start/Pause Twice

AP will be displayed (integrated: Orange LED above start/pause button showing)

Press Keylock

Turns Auto Power on & off. Scrubbing brush or secondary control panel LEDs showing = AP on, Scrubbing brush or secondary control panel LEDs not showing = AP off

Press Power

Will exit & save selected setting

End of Cycle Beeps (EC):-

(six beeps at the end of every cycle)

Press and hold Eco, then Keylock for 5 seconds

rA will be displayed

Press Start/Pause Three Times

EC will be displayed (integrated: Green LED above start/pause button showing)

Press Keylock

Turns end of cycle beeps on & off. Scrubbing brush or secondary control panel LEDs showing = EC on, Scrubbing brush or secondary control panel LEDs not showing = EC off

Press Power

Will exit & save selected setting

Closed Drawer Option (Ld):-

(lid closes automatically every time the drawer is closed)

Press and hold Eco, then Keylock for 5 seconds

rA will be displayed

Press Start/Pause Four times

Ld will be displayed (integrated: Red LEDs above start/pause & keylock buttons showing)

Press Keylock

Turns closed drawer option on & off. Scrubbing brush or secondary control panel LEDs showing = Ld on, Scrubbing brush or secondary control panel LEDs not showing = Ld off

Press Power

Will exit & save selected setting

Clean/Dirty Dish Option (dS):-

(clean dishes symbol stays on at end of cycle until cleared by pressing power)

Press and hold Eco, then Keylock for 5 seconds

rA will be displayed

Press Start / Pause Five times

dS will be displayed (not available on integrated models)

Press Keylock

Turns clean/dirty dish option on & off. Scrubbing brush showing = dS on, Scrubbing brush not showing = dS off

Press Power

Will exit & save selected setting

Water Softener Supply Hardness Setup(hd) (where fitted):-

(alters the Water Softener setting depending on Water Supply hardness)

Press and hold Eco, then Keylock for 5 seconds

RA will be displayed

Press Start / Pause once

Hd will be displayed (integrate: Green LED above Start / Pause Button showing)

Press Keylock

The Water Softener setting will advance on the Secondary Control Panel LED's with each press.

Press Power.

Will exit and save selected settings.

5.0 DIAGNOSTICS

5.1 DishDrawer Diagnostics

Dishwasher Diagnostics can **only** be entered in **Power Off mode**, **ie.** When there is no display on the LCD or the badge LED's are off. Diagnostics is entered by holding the **Keylock** and **Start/Pause** buttons simultaneously for 5 seconds. Ensure that **Keylock** is pushed first.

There are currently four levels of diagnostics. To move to the next level push **Power**. To enter a level push **Start/Pause**. Once a level has been entered, pushing **Power** will exit diagnostics completely. If no level is entered then the display will cycle through the four levels and exit after the last. On entering diagnostic mode the first level is the Display/Download Mode.

5.1.1 Display / Download Mode

In this mode all LED's and LCD segments (except keylock) are illuminated.

5.1.2 Optical LED Download / Fault Display

An optical data download is available here to download all EE data to a PC or Palm PC via the lower tub-home sensor light pipe. Hold the reader pen over the lower tub-home sensor light pipe and press **Start/Pause** to initiate the download. A short beep indicates the start and finish of download.

The last two faults are displayed on the LCD (secondary control panel LEDs for integrated models) during the optical download, the Current Fault code is displayed first followed by the Previous Fault Code. To read the Fault Code on the secondary display refer to Section 7.1 on Fault Codes.

5.1.3 Clearing Fault Logs

To Clear the current Fault press the **Keylock** button until a beep is sounded. This action moves the Current Fault into the Previous Fault while clearing the Current Fault. To Clear the Previous Fault press **Keylock** once more until the beep is sounded.

Warning: Once a fault has been cleared, it is permanently removed from Memory and cannot be recovered.

Press **Power** to advance to the next level.

5.1.4 Hardware Output Diagnostic Test Mode

This level tests all the hardware outputs and inputs. The LCD display shows 'HO'.

Press **Power** to skip hardware diagnostics and advance to the next level.

Press **Start/Pause** to enter hardware diagnostics.

Once hardware diagnostics has been entered letters in the LCD display indicate the current hardware output being tested and for integrated models the LEDs on the touch switch panel, using binary encoding, as shown in the table on the next page.

Different combinations of outputs can be switched on or off together but the controller will prevent higher current drawing components such as the wash pump and the lid motors being turned on together.

Press **Start/Pause** to advance to the next hardware output.

Press **Keylock** to turn the currently displayed output On or Off. If the scrubbing brush symbol (*green LED above start/pause button on integrated models*) is displayed then that output has been switched on, and if it is not displayed then that output is off.

Press **Power** to Exit at any time (All outputs will be switched off on exit).

As mentioned above the LCD display and touch switch panel LED's are illuminated to correspond to a particular hardware device. The following table details the display order of the test.

LCD	Norm	Fast	Deli	Rinse	Hardware Output
bL	Off	Off	Off	<u>On</u>	Backlight
Er	Off	Off	<u>On</u>	Off	Element Relay
Ld	Off	Off	<u>On</u>	<u>On</u>	Lid Motors (will run for 10 seconds)
dd	Off	<u>On</u>	Off	Off	Detergent Diverter Valve
FU	Off	<u>On</u>	Off	<u>On</u>	Fill Water Valve
P1	Off	<u>On</u>	<u>On</u>	Off	Motor Wash direction (2300-2850 rpm)
P2	Off	<u>On</u>	<u>On</u>	<u>On</u>	Motor Drain direction (4200 rpm)
rd	<u>On</u>	Off	Off	Off	Rinse Aid Dispenser (dispenses current setting)
dF	<u>On</u>	Off	Off	<u>On</u>	Drying fan
LE	<u>On</u>	Off	<u>On</u>	Off	Rinse Aid LED
C1	<u>On</u>	Off	<u>On</u>	<u>On</u>	Water Softener Diverter Valve
C2	<u>On</u>	<u>On</u>	Off	Off	Water Softener Brine Pump
°C	<u>On</u>	<u>On</u>	Off	<u>On</u>	Displays current water temperature.
°E	<u>On</u>	<u>On</u>	<u>On</u>	Off	Displays controller rail voltage (C3 is used in the Factory to empty the Water Softener before the Product is packed.)

WARNING : In diagnostic mode there is no component protection. Therefore take care when running individual components not to overload them. It is advisable to avoid turning the element on without filling the tub with water first.

NB : No Fault codes will come up while in diagnostics mode.

Tub Home Sensor Test: At any time during HO test mode the **Keylock** symbol on the LCD display (*Keylock LED on integrated badge*) indicates the tub position. On = Closed, Off = Open.

5.1.5 Fast Test Cycle

This level runs a 5 minute fast test cycle.

Press **Power** to skip Fast Test Cycle and advance to the next level.

Press **Start/Pause** to enter Fast Test cycle.

Once Fast Test Cycle is selected the DishDrawer goes into standby mode and 5 minutes will be showing on the display. The test cycle is started by pushing **Start/Pause** and the following components are run during the 5 minute cycle that follows:- Lid motors, fill valve, wash motor, element, drain motor.

Press **Power** to Exit at any time.

5.1.6 Continuous Cycle Test Mode

In this level the DishDrawer can be run continuously in any wash cycle. Once the cycle has finished, the DishDrawer automatically restarts the same wash cycle.

Press **Power** to skip Continuous Cycle. As this is the last level, doing this will exit diagnostics. Press **Start/Pause** to enter Continuous Cycle.

Once selected the LCD backlight flashes on and off to indicate the DishDrawer is in continuous cycle and the cycle starts straight away (*for integrated models the LED above the start/pause button will be orange instead of green to indicate the DishDrawer is running in continuous cycle*). It will run the last cycle that had been selected prior to going into diagnostics mode.

If you wish to run a different cycle you need to exit diagnostics turn the DishDrawer on as normal and select the cycle you want. Then turn the DishDrawer off again reenter diagnostics and restart the Continuous Cycle as above.

Press **Power** to Exit at any time.

Cycle Count Retrieval

(not available on integrated models)

To display the cycle count on the LCD screen, pause the DishDrawer while running a Continuous Cycle. The two bytes of the cycle count will be displayed alternately, in synchronisation with the changing backlight.

The Low byte is displayed when the backlight is Off.

The High byte is displayed when the backlight is On.

To calculate the Total DishDrawer cycle count use the formula below....

$$\text{Cycle_Count} = (200 \times \text{High_byte}) + \text{Low_byte}.$$

Eg. Low_byte = 156
 High_byte = 2
 Cycle_count = (200 x 2) + 156 = 556.

5.1.7 Temperature & Voltage Display Mode

(not available on integrated models)

During a wash cycle, the current water temperature or the power supply rail voltage of the controller can be displayed on the LCD instead of the time remaining. To enter temperature/voltage display mode, start a wash cycle as normal. Initiate a keylock by pushing and holding the **Keylock** button for 4 seconds.

Once in keylock mode push and hold **Start/Pause** for 8 seconds to enter temperature display mode. The display now alternates between a °C symbol and the water temperature. Pressing the **Start/Pause** again changes the display to alternate between an °E symbol and the power supply rail voltage of the controller.

To cancel temperature/voltage display mode, press the **Power** button.

5.1.8 Show Off / Showroom Wash Mode

This mode initiates a shop show off display and wash operation demonstration.

With the DishDrawer powered up and turned on the show off mode is entered by holding the **Eco** and **Power** buttons simultaneously for 5 seconds. Ensure that **Eco** is pushed first.

The DishDrawer is now in the Show Off mode and cycles through all of the LED & LCD segments while pulsing the LCD backlight on and off.

Pressing the **Power** button now puts the DishDrawer into the Showroom Wash mode. Before running this mode the tub should be filled with water until it is just touching the underside of the spray arm. The Showroom Wash is started by pushing the **Start/Pause** button whereby the following cycle is run:-

The lid is pulled down

The wash motor starts and runs for 4 minutes

The wash motor stops.

The lid is lifted

The display counts down to zero throughout this cycle

The DishDrawer turns off at the end of this cycle.

The DishDrawer is still in the Showroom wash mode however and it can be rerun by pushing **Power** and then **Start/Pause**. Once Show Off/Showroom Wash mode has been initiated, the mains power must be removed to exit out.

6.0 DIAGNOSTICS QUICK REFERENCE CHARTS

6.1 Fault Display/Download Mode:-

Press and hold Keylock, then Start/Pause for 5 seconds

All LEDs & LCD segments except Keylock are illuminated

Press Start / Pause

This initiates Pen upload via lower tub-home light pipe. At the same time the current and then the previous fault code will be displayed in the LCD screen & on the secondary control panel LEDs. To read the fault code on the secondary display refer to Section 7.1 on Fault Codes.

Press Keylock

This will clear current fault code. Note if you press Keylock again you will remove the previous fault

Press Power

To exit

6.2 Hardware Output Test Mode:-

Press and hold Keylock, then Start/Pause for 5 seconds

All LEDs & LCD segments except Keylock are illuminated

Press Power Button Once

HO will show in the display (integrated: Heavy, Normal, Fast, Delicate, Rinse LEDs showing)

Press Start/Pause

Scroll through the following outputs using Start/Pause. Turn the outputs on & off using Keylock button.

Press Power

To exit

Note: Scrubbing Brush = output on, No Scrubbing Brush = output off (on integrated models a green LED above the start/pause button is used in place of the scrubbing brush)

LCD Display	Norm LED	Fast LED	Deli LED	Rinse LED	Hardware Output
bL	Off	Off	Off	<u>On</u>	Backlight
Er	Off	Off	<u>On</u>	Off	Element Relay
Ld	Off	Off	<u>On</u>	<u>On</u>	Lid Motors (will run for 10 seconds)
dd	Off	<u>On</u>	Off	Off	Detergent Diverter Valve
FU	Off	<u>On</u>	Off	<u>On</u>	Fill Water Valve
P1	Off	<u>On</u>	<u>On</u>	Off	Motor Wash direction (2300-2850 rpm)
P2	Off	<u>On</u>	<u>On</u>	<u>On</u>	Motor Drain direction (4200 rpm)
rd	<u>On</u>	Off	Off	Off	Rinse Aid Dispenser (dispenses current setting)
dF	<u>On</u>	Off	Off	<u>On</u>	Drying fan
LE	<u>On</u>	Off	<u>On</u>	Off	Rinse Aid LED
C1	<u>On</u>	Off	<u>On</u>	<u>On</u>	Water Softener Diverter Valve
C2	<u>On</u>	<u>On</u>	Off	Off	Water Softener Brine Pump
°C	<u>On</u>	<u>On</u>	Off	<u>On</u>	Displays current water temperature.
°E	<u>On</u>	<u>On</u>	<u>On</u>	Off	Displays controller rail voltage

Tub Home Sensor test:- keylock symbol on = tub closed, off = tub open

6.3 Fast Test Cycle:-

Press and hold Keylock, then Start/Pause for 5 seconds,
All LEDs & LCD segments except Keylock are illuminated

Press Power Button Twice

FC will show in the display (integrated: Heavy, Normal, Delicate, Rinse LEDs showing)

Press Start/Pause Twice

The 5 minute fast test cycle will start

Press Power

To exit

6.4 Continuous Cycle:-

Press and hold Keylock, then Start/Pause for 5 seconds

All LEDs & LCD segments except Keylock are illuminated

Press Power Button Three times

CC will show in the display (integrated: Heavy, Normal, Rinse LEDs showing)

Press Start/Pause

The last cycle that had been selected prior to going into diagnostics mode will be run continuously

Press Power

To exit

6.5 Temperature & Voltage Display Mode:-

(not available on integrated models)

Start a wash cycle running

Press & hold Keylock for 4 seconds

Keylock will be activated

Press & hold Start/Pause for 8 Seconds

LCD will now alternate between °C symbol & the water temperature

Press Start/Pause

LCD will now alternate between °E symbol & the controllers rail voltage

Press & hold Keylock for 4 seconds

Keylock is deactivated

Press Power

To exit

7.0 FAULT CODES

The faults are displayed in the LCD as one of 5 F (fatal) faults or 1 U (user) fault along with the symbol of a spanner. A fatal fault will usually require the assistance of a qualified service person, while a U1 user fault indicates the machine had failed to prime within a certain length of time usually because the tap has not been turned on. For this reason at the same time a U1 comes up in the display we also show the symbol of a tap. In the Integrated models, an LCD is not available, and the presence of a fault is indicated by a Red center LED, with the fault number indicated on the touch switch panel with Red LED's.

Once a fault is repaired it can be cleared by pressing the **Power** button. If the fault is still present then it will not clear.

A fatal or user fault is accompanied by a continuous pulsating beep which can be turned off by pressing either the power, start/pause, or key lock button.

The last two faults are logged into EE memory.

The other U (user) faults have been removed. The old U2 fault, which was the tub forced open during a cycle, has been removed completely. Instead if the tub is forced open the product simply pauses as if someone had pressed the start/pause button. The old U3 fault, which indicated a failure to drain i.e. water left in the tub, will not show up a fault and the DishDrawer will continue through the cycle.

7.1 Fault Code Description Chart

The following chart is a quick reference guide on fault codes. To read a fault code off an integrated model, refer to the LED Display column on the chart below. The LED that has activated on the secondary display indicates which fault code has occurred.

Fault Code	LED Display	Fault	Possible Causes
F1	Rinse LED	The flood switch has been activated for more than six seconds	<ul style="list-style-type: none"> • Inlet hose to inlet valve connection loose • Inlet valve body leak • Damage to the fill or drain hoses • Heater plate damage (chipped enamel) • Seals/O Rings (pinched, contaminated or poor join) • Dispenser (seal, diverter valve or weld leak) • Lid area (lid motors not functioning correctly, lid off yoke or foreign object interfering with lid seal)
F2	Delicate LED	The motor has not been sensed rotating	<ul style="list-style-type: none"> • Foreign object has jammed the rotor • The rotor has failed • The hall sensor has failed • The electronic controller has failed
F3	Delicate and Rinse LED	The water temperature has been sensed at greater than 85°C (185°F)	<ul style="list-style-type: none"> • The incoming water is greater than 85°C (185°F) • The element has failed closed circuit • The temperature sensor has failed • The electronic controller has failed
F4	Fast LED	No temperature increase has been sensed for 2 hours while the element is on	<ul style="list-style-type: none"> • The element is not connected • The element has failed open circuit • The temperature sensor has failed • The electronic controller has failed
F9	Normal and Rinse LED	Electronics Failure	<ul style="list-style-type: none"> • The electronic controller has failed
U1	Heavy and Rinse LED	Machine has failed to prime with water within approx. 3 minutes	<ul style="list-style-type: none"> • The water supply is not turned on • The machine is syphoning • The spray arm is not in place • Excessive foaming • The Inlet Valve has failed • The electronic controller has failed • Rotor not fitted correctly

7.2 Fault Code Problem Solving Charts

The following charts can be used as a guide to help locate faults in a DishDrawer. Answer each question with a yes or no and follow the instructions inside the relevant box.

F1 The flood switch has been activated for more than 6 seconds			
	Question	Yes	No
1	Is there a F1 on both displays?	Go to Question 2	If power fails to the bottom tub it will cause the top tub to go F1. Test heater plate.
2	Has a flood occurred? (N.B. The flood may have dried up)	Go to Question 3	Go to Question 13
3	Is the lid sealing on the tub correctly?	Go to Question 5	Go to Question 4
4	Are the lid actuators functioning correctly?	Go to Question 5	Check the lid actuators are assembled correctly on the slides and yokes. Check the plugs on the RFI board and the terminals on the lid motors. If the lid actuators look slow replace them.
5	Is the water level in the tub high?	Go to Question 6	Go to Question 8
6	Is the water inlet valve leaking?	Replace inlet valve	Go to Question 7
7	Is the DishDrawer priming correctly?	Go to Question 12	Go to Question 8
8	Is the spray arm split?	Replace spray arm	Go to Question 9
9	Is the spray arm running freely?	Go to Question 10	Check the rotor is running freely, clear of foreign objects and fitted correctly. Make sure the wash impeller is not slipping off the rotor shaft
10	Is water leaking from a split inlet or drain hose?	Replace split inlet or drain hose	Go to Question 11
11	Is water leaking around the heater plate 'O' rings?	Replace or refit 'O' rings	Go to Question 12
12	Is the drain hose blocked?	Clear drain hose of blockage	Go to Question 13
13	Is there condensation or foreign matter around the flood switch PCB?	Clear flood sensor of condensation or foreign matter	Go to Question 14
14	After clearing water does the F1 fault code still activate?	Replace Chassis RFI board	Go to Question 15
15	Refer to Bulletin DW028		

F2 The motor is not sensed to be rotating			
	Question	Yes	No
1	Is the rotor jammed?	Free jammed rotor, check for foreign object damage to rotor and rotor housing.	Go to Question 2
2	Does the stator wiring from the controller test okay?	Go to Question 3	Replace wiring harness or repair faulty connections.
3	Do the stator windings show the correct resistance?	Go to Question 4	Repair or replace stator as required
4	Is the rotor position sensor clipped into the stator housing correctly? Is the sensor plugged into the controller with a good connection?	Go to Question 5	Clip rotor position sensor into stator housing or repair wiring connection at electronic controller.
5	Rotor position sensor fault?	Replace rotor position sensor	Go to Question 1

F3 Water temperature sensed at greater than 85°C (185°F)			
	Question	Yes	No
1	Is the incoming water temperature greater than 85°C (185°F)	Adjust the incoming water temperature.	Go to Question 2
2	Is the element on all the time?	Replace the electronic controller	Go to Question 3
3	Are the wiring and connections from the controller to the element all okay?	Go to Question 4	Repair or replace wiring harness or wiring connections
4	Are there any signs of moisture around the temperature sensor?	Locate and repair source of leak	Go to Question 5
5	Is the resistance of the temperature sensor correct?	Go to Question 6	Replace heater plate assembly
6	Does the machine fault again if run through a test cycle?	Go to Question 1	No fault found

F4 No temperature increase has been sensed while the element is turned on			
	Question	Yes	No
1	Does the element heat in diagnostics?	Go to Question 7	Go to Question 2
2	Test the resistance of the heater element using the connection on the controller, is it correct?	Go to Question 3	Go to Question 5
3	Is the connection on the controller okay?	Go to Question 4	Replace or repair connection
4	Electronic controller failure?	Replace electronic controller	Go to Question 1
5	Are the wiring and connections from the controller to the element all okay?	Go to Question 6	Repair or replace wiring harness or wiring connections
6	Is the resistance of the heater element correct?	Go to Question 7	Replace heater plate
7	Is the resistance of the temperature sensor correct?	Replace electronic controller	Go to Question 8
8	Are the wiring and connections down to the temperature sensor okay?	Go to Question 9	Replace or repair wiring harness or wiring connections
9	Heater element failure?	Replace heater plate	Go to Question 1

F9 Electronics failure (EEPROM access error)			
	Question	Yes	No
1	If the DishDrawer is isolated from the power supply for 10 seconds, does the fault clear?	No fault found	Go to Question 2
2	Electronic controller failure?	Replace electronic controller	Go to Question 1

U1 DishDrawer failed to prime with water within approx. 3 minutes			
	Question	Yes	No
1	Is the tap turned on?	Go to Question 2	Turn the tap on
2	Is the spray arm in place? (spray arm may have been refitted since U1 fault occurred)	Go to Question 3	Refit spray arm
3	Activate the water inlet valve in diagnostics. Does any water enter the machine?	Go to Question 4	Go to Question 7
4	Is the impeller on the rotor slipping?	Replace the rotor	Go to Question 5
5	Is the supply water pressure above 30Kpa (4.3p.s.i)?	Go to Question 6	The DishDrawer requires a minimum water pressure installation of 30Kpa (4.3p.s.i)
6	Are the inlet water hoses and valves free of any blockages or obstructions?	Go to Question 10	Clear the water valves or hoses of blockage or obstruction
7	Is the resistance of the water inlet valve measured at the plug on the controller correct?	Go to Question 8	Go to Question 9
8	Is there 24V DC coming from the controller during the water inlet valve test?	Go to Question 6	Replace the electronic controller
9	Are the wiring and edge connections down to the water inlet valve okay?	Go to Question 10	Replace or repair wiring harness or wiring connections
10	Water inlet valve failure?	Replace water inlet valve	Go to Question 11
11	Is the Rotor fitted correctly?	Go to Question 1	Refit Rotor

7.3 Poor Dry Performance

Poor Dry Performance			
	Question	Yes	No
1	Is the customer complaining of plastic items not drying?	Advise customer that due to plastics having a low thermal mass these items give inherently bad drying performance	Go to Question 2
2	Is the customer using rinse aid?	Go to Question 3	Advise customer that the use of rinse aid will improve dry performance
3	Is the customer using Fast or Eco cycles	Advise customer that due to lower final rinse temperatures dry performance is comprised when using Fast and Eco cycles (there is less residual heat for drying at the end of cycle)	Go to Question 4
4	Is the rinse aid setting high enough for the water hardness in the area?	Go to Question 5	Turn the rinse aid up to a higher setting
5	Using diagnostics test the dispenser. Is it dispensing the correct amount of rinse aid?	Go to Question 1	Replace dispenser

7.4 Poor Wash Performance

Customers Complaint Food Particles left on Dishes	
Cause of problem (1)	Spray arm has stopped rotating.
How to resolve the problem	a) One of the dishes / cutlery / utensils has fallen through the basket and jammed the spray arm, remove the obstruction. b) Filter plate, drain filter, or drain filter access panel is not installed correctly and is causing the spray arm to jam.
Cause of problem (2)	The product is being over loaded or incorrectly loaded with dishes.
How to resolve the problem	Advise customer of correct loading.
Cause of problem (3)	Customer is selecting the wrong wash cycle for the soil level on the dishes.
How to resolve the problem	Advise customer about reduced water temperatures (up to 20°C / 70°F lower) and wash times when using Fast and Eco cycles.

Customers Complaint Coffee/Tea Stains left in Cups	
Cause of problem (1)	Not enough detergent being used. To remove these stains requires a stronger concentration of detergent in the water. More detergent is also required in hard water areas as minerals in the hard water reduce the effectiveness of the detergent.
How to resolve the problem	Fill the main-wash detergent cup to the top & for best results also fill the pre-wash detergent cup. Run on normal or heavy cycles not Eco.
Cause of problem (2)	The product is being over loaded which is preventing water reaching the cups on the upper cup racks.
How to resolve the problem	Advise customer of correct loading.

Customers Complaint Dishes have blotchy marks on them that look like water stain marks not food	
Cause of problem	Not enough rinse aid being used. The water is not soft enough during the final rinse and therefore hard water droplets containing impurities are drying on the dishes instead of running off during the dry cycle.
How to resolve the problem	Confirm that the customer is using rinse aid. The rinse aid may need to be turned up to a higher setting (4 or 5 lights) and for optimum dry performance run the DishDrawer on normal or heavy cycles not Eco. Check that the rinse aid dispenser is dispensing correctly in diagnostics.

Customers Complaint Glasses & Cutlery have a Cloudy White film on them and/or Plates have a White Chalky film on them

Cause of problem	Hard water & not enough detergent being used. Minerals from the water are building up on the dishes or the Water Softener is not set to the correct Water Hardness Level or is faulty.
How to resolve the problem	<p>Once this film forms on the dishes it cannot be removed by normal running in the dishwasher. The dishes will need to be cleaned by soaking them in an acidic solution such as white vinegar and water.</p> <p>Where a Water Softener is not fitted; To prevent the build up re-occurring the customer will need to fill both the main-wash & pre-wash detergent cups to the top with a power detergent and we would recommend running on normal cycles.</p> <p>In problem areas with very hard water the customer may need to use a detergent additive designed for use in hard water areas or fit a water softener to the incoming water supply.</p> <p>Where a Water Softener is fitted; Set the Water Softener for the correct local Water Supply hardness. Check that the Water Softener is functioning correctly in Diagnostics;</p> <p>C1 Water Softener Diverter Valve In hardware output Diagnostics Test Mode FU – turn the Fill Water Valve on P2 – turn the Motor Drain on C1 – Water Softener Diverter Valve On – water bypasses the resin tank Off – water flows through the resin tank</p> <p>C2 Water Softener Brine Pump Turn the Brine Pump on in Diagnostics mode. Observe a small quantity of water (approx. 30 ml per min.) flowing out the bottom of the dispenser. (Drop the Dispenser Door down to observe this.) Observe a change in the water level (approximately 120ml per 4 min.) in the Salt Reservoir. The Reservoir should pump dry of water in this time. Note:- Fill the Salt Reservoir with Salt (and then water if not already) before performing this test.</p> <p>Pipe Interrupter (Air Break) Function A critical component in the performance of the Water Softener is the pipe Interrupter (PI). There is a certain amount of spray leakage from the PI which is used to provide water to the Salt Reservoir.</p> <p>If the spray is inadequate, there will be insufficient water in the Salt Reservoir to make Brine.</p> <p>If there is too much spray then the excess bypasses the Water Softener and defeats the softening process by pouring untreated water into the Tub.</p> <p>To check that the amount spray leakage is appropriate:- Fill the Salt Reservoir with water.</p>

In diagnostics mode, Turn on the Fill Water Valve, and the Motor Drain. Water will flow out of the Dispenser into the Tub, as well as out of the Water Softener Overflow into the Tub.

Observe the flow from the Water Softener Overflow (beside the Dispenser). There should be a trickle (25-100 ml per minute). With experience you can guess what is appropriate. If the trickle is outside these rates, replace the softener as the PI is faulty.

To check that there is water in the Salt Reservoir, remove the Drawer front and observe the level of water in the tank. (A quick way to check that there is water in the Salt Reservoir is to remove the Salt Bung and test the water level by placing your finger down through the opening.)

Detergent or Rinse Aid in the Water Softener

If detergent or rinse aid is poured in to the Salt Reservoir it will destroy the Water Softener. This could also happen if the Salt Bung is left off or falls out. Evidence of this could be white streaks through the Resin.

8.0 WIRING DIAGRAM

Phase 3.5 Dishdrawer Wiring diagram (1 drawer only shown)

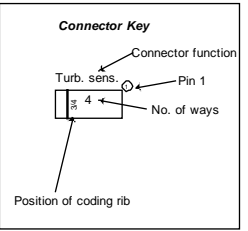
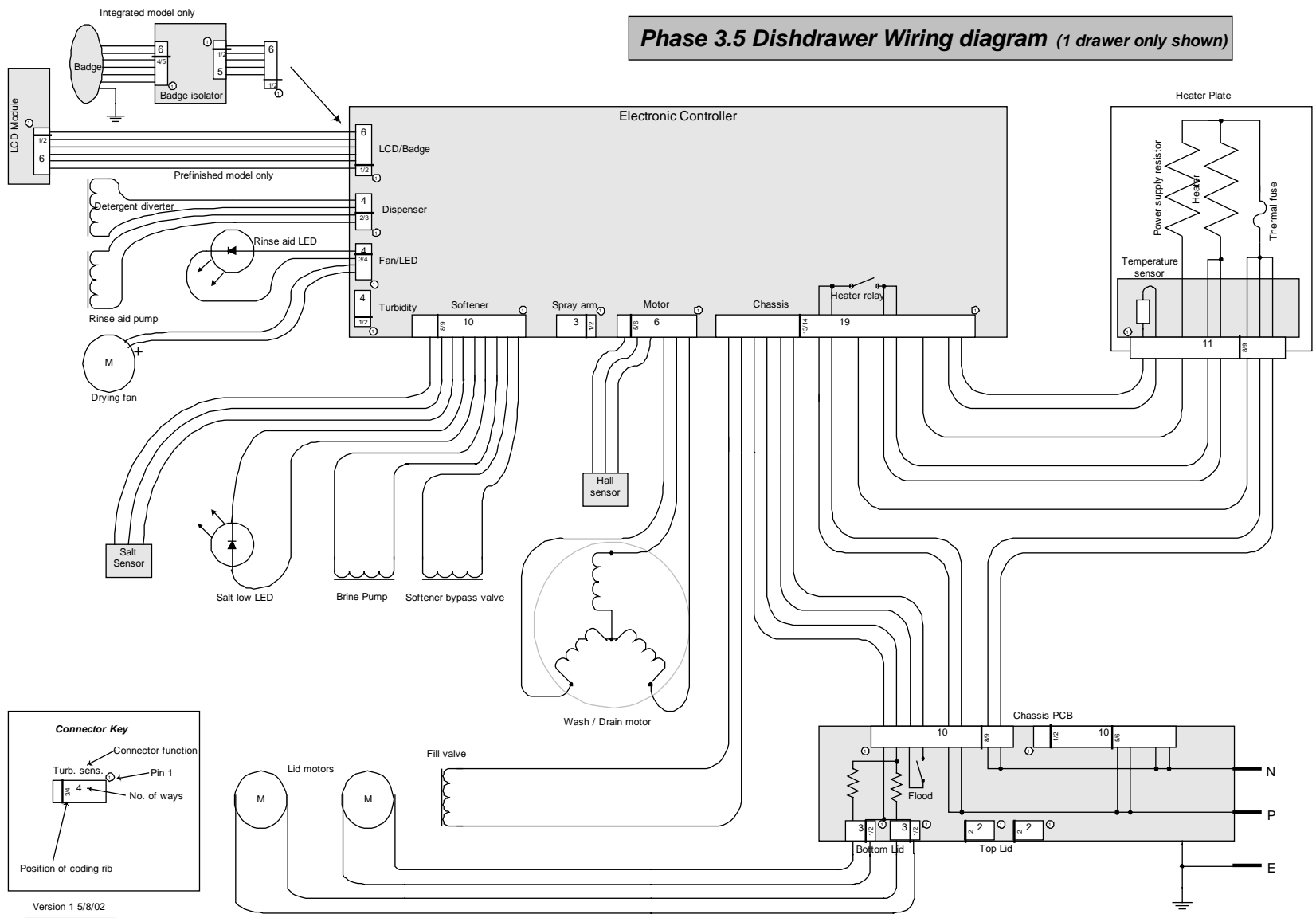

Version 1 5/8/02
 R. Butler 2002

9.0 SERVICE PROCEDURES

CAUTION:- Due to the use of an electronic switchmode power supply all internal components regardless of supply voltage should be treated as live to earth when power is supplied to the DishDrawer.

9.1 Drawer Front Removal

9.1.1 Slide open drawer.

9.1.2 Locate draw pin on either side of the tub.



9.1.3 Using a sharp pair of long nose pliers or slip jaw pliers grasp the center dividing web of the pin and pull away from the tub to remove the pin. Support the drawer front with your hand while doing this.



Note: The pin web is vertical.

9.1.4 With both pins removed the bottom of the drawer front can now be eased out slightly.

9.1.5 Now carefully pull the drawer front down to allow it to come free from the handle and top locating slots.

9.1.6 Carefully remove the earth wire from the tab on the drawer front. *(if it is an integrated model you will also need to unplug the integrated badge from the isolating module)*

9.1.7 Refit in reverse manner ensuring the drawer slides are right forward and the pin secures through the hook on the front end of the slide.

Note: When reinserting the pins make sure the dividing web is vertical.

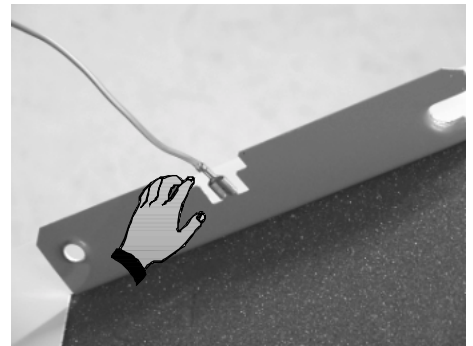

9.2 Tub Removal

9.2.1 Open the drawer fully.



9.2.2 Depress the right-hand tub clip and push it back about 30mm (1 inch). Repeat for the left-hand side.

9.2.3 The tub may now be lifted up off the drawer runners.

9.2.4 Slide both runners back into the product.

9.2.5 Refit in reverse manner.

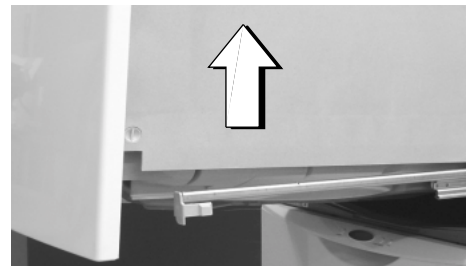
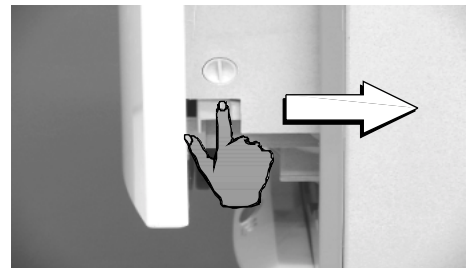

9.3 Drawer and LCD Display Removal

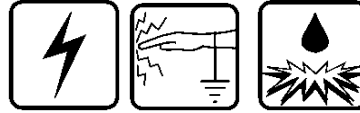

- 9.3.1 Remove the drawer front as per instructions in 9.1.
- 9.3.2 The handle fits onto a lip at the top of the tub and then slides from left to right to lock into place. Push the right-hand end of the handle to the left until it feels free then remove it out towards you.
- 9.3.3 Disconnect the six wire harness from the electronic controller to the LCD interface.
- 9.3.4 The handle may now be lifted clear. The LCD display is held in place by a spring tab on one end and a clip in the centre. Use a small blade screwdriver to carefully release the tab and centre clip as shown. The LCD assembly can now be removed.
- 9.3.5 The wiring harness can now be unplugged from the LCD.
- 9.3.6 Refit in reverse manner.

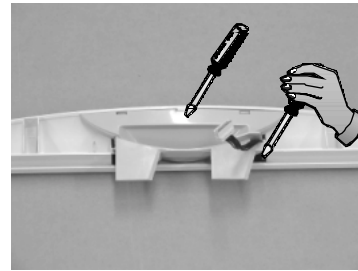
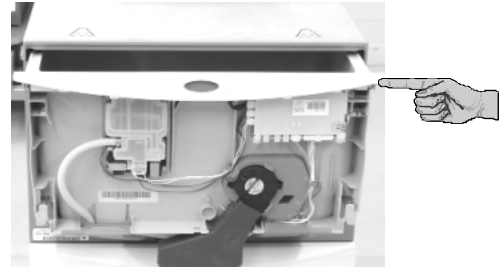

9.4 Drying Fan Removal



- 9.4.1 Remove the drawer front as per instructions in 9.1.
- 9.4.2 With a small bladed screwdriver carefully release the small plastic clips holding the rinse aid indication LED in place and remove the LED.
- 9.4.3 Slide forward the drying fan duct and remove.
- 9.4.4 Disconnect the four wire harness from the electronic controller
- 9.4.5 Release the three securing tabs that hold the drying fan in place while applying forward pressure on the drying fan.
- 9.4.6 The drying fan will now come free.
- 9.4.7 Refit in reverse manner.

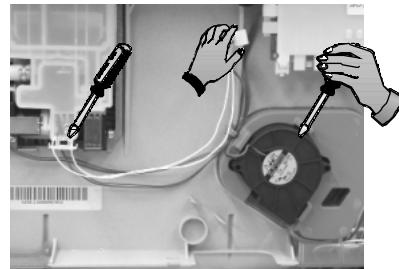

9.5 Detergent Dispenser

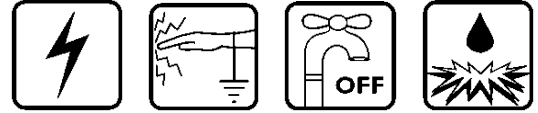

9.5.1 Remove the drawer front as per instructions in 9.1.

9.5.2 Disconnect the two wiring loom connections off the dispenser coils.

Note: Push back locking tabs to allow connectors to release.

9.5.3 With a small bladed screwdriver carefully release the small plastic clips holding the rinse aid indication LED in place and remove the LED.

9.5.4 Unclip the fill hose on the dispenser

9.5.5 While holding the dispenser unscrew the six T10 Torx drive screws securing the brackets around the dispenser.

9.5.6 The dispenser can now be removed from inside the tub.

9.5.7 To open up the dispenser door fully, first open the door using the release catch then squeeze the top sides of the door. This will release the door to the fully open position. This can be done with the dispenser in place.

9.5.8 Refit in reverse manner ensuring the dispenser gasket is located correctly.

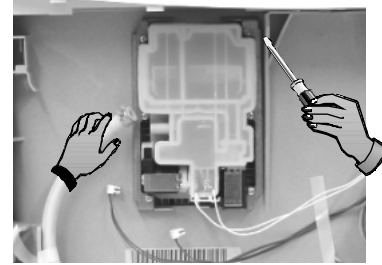

9.6 Electronic Controller

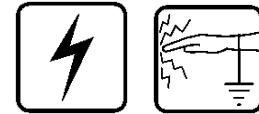

9.6.1 Remove the drawer front as per instructions in 9.1.

9.6.2 Disconnect all the wiring connectors on the controller apart from the LCD/Badge plug

9.6.3 Now release the clip on the right-hand side of the controller just below the light pipes by firmly pushing it in towards the controller.

9.6.4 The bottom of the controller can now be lifted out to an angle of about 45° at which point the top of the controller will come free.

9.6.5 Disconnect the LCD/Badge plug.

9.6.6 Refit in reverse manner.

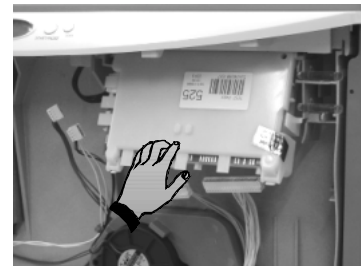

9.7 Filter Plate Removal

- 9.7.1 Remove the lower racks from the tub.
- 9.7.2 Remove the drain filter assembly.
- 9.7.3 Rotate the filter plate locknut anti-clockwise to release the filter plate from the rotor assembly.
- 9.7.4 Lift the filter plate clear.
- 9.7.5 Refit in reverse manner.



9.8 Rotor Assembly Removal

- 9.8.1 Remove filter plate as per instructions 9.7.
- 9.8.2 Rotate the rotor locking ring anti clockwise to release it from the motor assembly and lift out.
- 9.8.3 The rotor assembly is not serviceable.
- 9.8.4 Refit in reverse manner.



9.9 Wiring Cover Removal



- 9.9.1 Remove the drawer front as per instructions in 9.1.
- 9.9.2 With the tub opened release the tub clips and push back the drawer rails as explained in 9.2.2.
- 9.9.3 Carefully release the four wiring cover clips from the front lower section of the tub taking care not to damage them.
- 9.9.4 Release the three clips on the underside of the tub which retain the wiring cover.
- 9.9.5 Pull the tub fully open and lift it up at the front (this makes it easier to remove the wiring cover from the rear of the tub).
- 9.9.6 The wiring cover may now be carefully moved forward to release it from the rear of the tub.
- 9.9.7 To reassemble first ensure that the wiring harnesses, drain hose and fill hose are clipped into their correct position.
- 9.9.8 Then refit in reverse manner

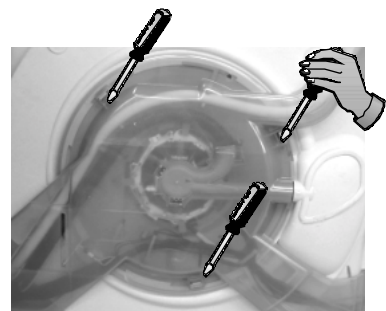

9.10 Tub Disconnection



- 9.10.1 Remove the drawer front as per instructions in 9.1.
- 9.10.2 Remove the wiring cover as per instructions in 9.9.
- 9.10.3 Disconnect the fill hose from the dispenser (water may drip).
- 9.10.4 Disconnect the chassis harness plug from the electronic controller.
- 9.10.5 Disconnect the element harness plug and earth wire from the element plate.
- 9.10.6 Unclip the drain hose cuff from the motor assembly taking care not to misplace the non-return flap valve.
- 9.10.7 Unclip the drain hose, fill hose and the wiring loom from the under side of the tub.
- 9.10.8 Now remove the tub as per instructions in 9.2.
- 9.10.9 Refit in reverse manner.

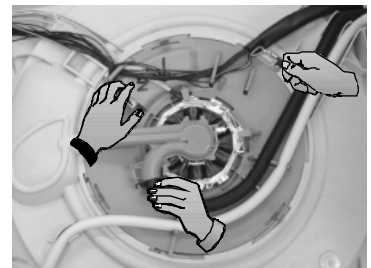

Note: When replacing a fill hose, transfer the Link Support clip markings from the old to the new hose.

9.11 Rotor Sensor Removal



- 9.11.1 Remove the wiring cover as per instructions in 9.9.
- 9.11.2 Unplug the wiring connection from the rotor sensor.
- 9.11.3 Release the tab locking the rotor sensor in place as shown and lift the rotor sensor out.
- 9.11.4 Refit in reverse manner.

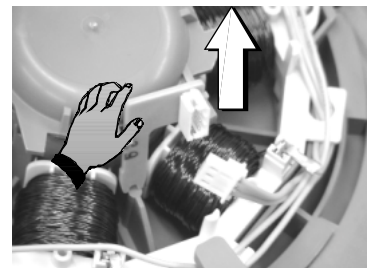

9.12 Locking Ring, Element Plate and Motor Assembly Removal

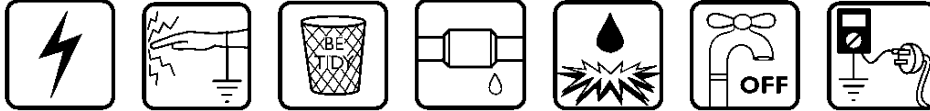

9.12.1 Remove the drawer front, filter plate and rotor assembly as per instructions in 9.1 and 9.7 and 9.8.

9.12.2 Remove the wiring cover and disconnect and remove the tub as per instructions in 9.9 and 9.10 and 9.2.

9.12.3 Unplug the motor wiring harness from the electronic controller.

9.12.4 While lifting the tab on the locking ring as shown, rotate the ring anti-clockwise until it comes free of tub tabs.



9.12.5 Take care not to damage any motor wiring as the locking ring is turned (refer picture).

9.12.6 This also releases the motor housing from the locking ring.

9.12.7 Holding the pump housing on the motor assembly lift the locking ring, heating plate and motor clear of the tub.

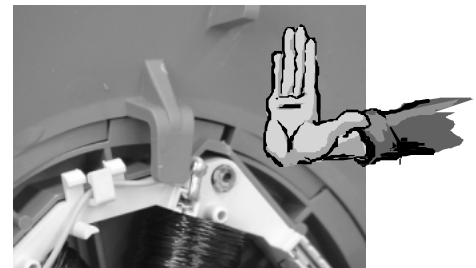

9.12.8 The suction pipe of the drain molding will slide out of the tub drain area.

9.12.9 You may now lift the locking ring clear of the motor assembly. This will allow the heater plate and motor assembly to come apart

9.12.10 Be careful of the two large 'O' rings which seal between the motor assembly and heater plate and the heater plate and tub, these and the tub sealing area must be clean and put in the correct place before reassembly takes place.

9.12.11 Check both the drain cuff 'O' ring and suction pipe 'O' ring for deformation and damage. Lubricate and if necessary replace 'O' rings before reassembly.



9.12.12 Reassemble in reverse manner ensuring all locking ring tabs are engaged.

9.13 Lid Removal



- 9.13.1 Remove tub assembly as per instructions in 9.2.
- 9.13.2 On the right-hand side of the lid release the two tabs that clip the lid to the yoke. Repeat for the left-hand side.
- 9.13.3 The lid is now free to slide out of the chassis.
- 9.13.4 Refit in the reverse manner taking care that the lid is fitted the correct way around. The front is indicated on the top of the lid.

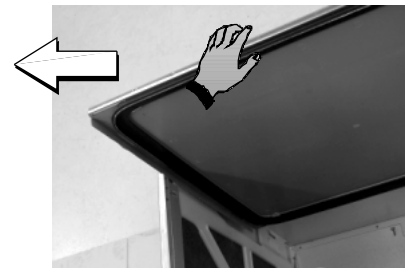

9.14 Yoke Removal



- 9.14.1 Remove the lid as per instructions in 9.13.
- 9.14.2 Release the lid actuator connecting arm from the bottom of the yoke by squeezing the two tabs towards each other.
- 9.14.3 Pulling in the centre of the yoke to bow it out will allow the ends of the yoke to come free from the chassis so it can be removed.
- 9.14.4 Refit in the reverse manner taking care that the yoke is the correct way around.

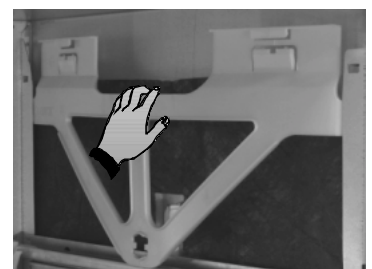

9.15 Lid Actuator Removal



9.15.1 Remove the tub as per instructions in 9.2. For top tub lid actuators the bottom tub must also be removed to gain access to the lid actuator wiring harness.

9.15.2 Release the lid actuator connecting arm from the bottom of the yoke by squeezing the two tabs towards each other.

9.15.3 Remove the cover from the chassis module as explained in 9.17. Disconnect the appropriate lid actuator wiring harness from the chassis circuit board and unclip the wiring harness back to the lid actuator.



9.15.4 For a right-hand lid actuator carefully release the clip at the back of the lid actuator and slide the lid actuator towards the rear of the chassis to release it from the slide rail.

9.15.5 For a left-hand lid actuator the clip is at the front of the lid actuator and once released the lid actuator will slide towards the front of the chassis to release it from the slide rail.

9.15.6 The lid actuator can now be removed.

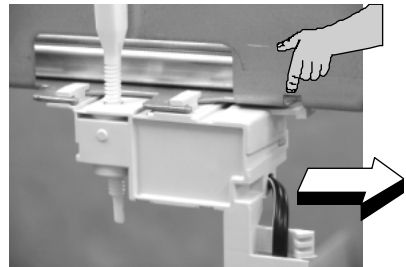

9.15.7 When reconnecting a lid actuator to a yoke it is recommended to have the lid and yoke assembly pushed hard up against the upper stops. To line up correctly the lid actuator connecting arm may need to be wound up or down manually prior to clipping to the yoke. Care needs to be taken when working on a lower tub that the lid and yoke assembly don't accidentally get fitted above the upper stops.

9.16 Slide Rail Replacement



- 9.16.1 Remove the Tub as per instructions in 9.2.
- 9.16.2 Remove the lid actuator from the slide rail as per instructions in 9.15.
- 9.16.3 Bottom slide rails only. The lower plastic chassis trim must be removed as per instructions in 9.22 to gain access to the screws securing the front of the slide rail. Remove the two hex drive screws securing the slide runner at the front.
- 9.16.4 Tap the slide rails from underneath at the front. This will knock the slide rail up and free from its location in the chassis.
- 9.16.5 The slide runner may now be pulled forward to release it from its location in the rear of the chassis.
- 9.16.6 Refit in reverse manner.

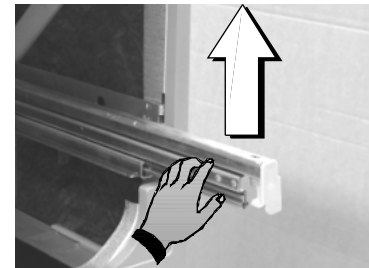
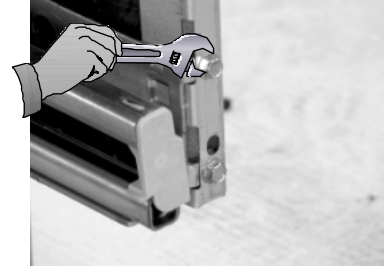

9.17 Chassis Circuit Board / Flood Sensor Removal



- 9.17.1 Remove lower tub as per instructions in 9.2.
- 9.17.2 Release clip on chassis module cover and slide cover to the right to remove.
- 9.17.3 Disconnect all wiring to the chassis circuit board taking care not to damage the small lid actuator motor plugs.
- 9.17.4 Remove centre earth screw from chassis circuit board.
- 9.17.5 Release the clip holding the left-hand end of the circuit board down.
- 9.17.6 Carefully lift the left-hand end of the circuit board up and then to the left taking care not to damage the flood sensor.
- 9.17.7 Refit in reverse manner

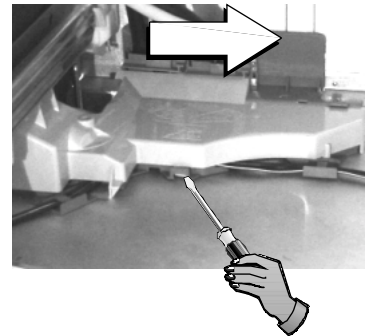

9.18 Water Valve Removal



- 9.18.1 Remove the lower tub as per instructions in 9.2.
- 9.18.2 Remove the chassis module cover as per instructions in 9.17.
- 9.18.3 Disconnect the wiring connections to both solenoid coils.
Release the locking tabs for the connectors with a blade screwdriver while doing this.
- 9.18.4 Disconnect the inlet hose connection.
- 9.18.5 You can now slide the water valve up out of its mounting bracket.
- 9.18.6 Disconnect the two fill hoses off the valve noting which hose goes to the top and tub and which goes to the bottom tub.
- 9.18.7 Refit in reverse manner.

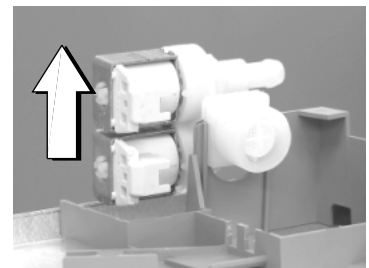
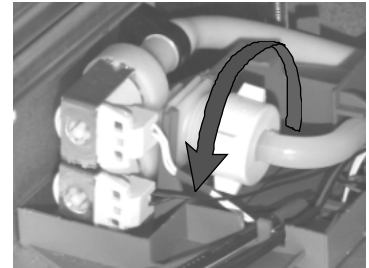

9.19 Fill Hose, Drain Hose, Wiring Harness Replacement



- 9.19.1 Remove wiring cover as per instructions in 9.9.
- 9.19.2 Remove tub as per instructions in 9.2.
- 9.19.3 From the tub end disconnect the component you need to replace (fill hose, drain hose, wiring harness).
- 9.19.4 Remove the relevant component from each of the three link clips and the chassis clips holding it.
Do this one at a time marking its position at each clip in the link and closing each clip after the component is removed to keep the other two components clipped in the correct position.
- 9.19.5 The component can now be disconnected from the chassis end and removed.
- 9.19.6 Refit in the reverse manner ensuring the link clips are clamping the components in their correct location.

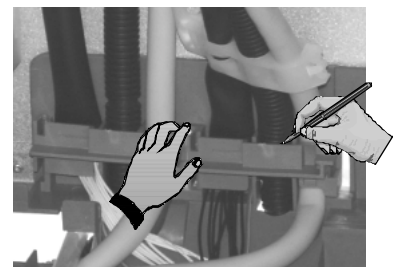
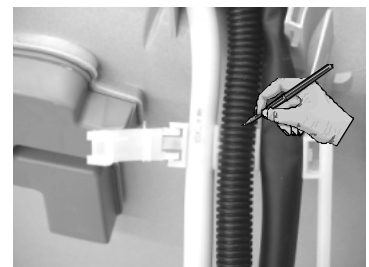

9.20 Toe Kick Removal



- 9.20.1 Partly open bottom drawer.
- 9.20.2 Loosen the right and left hand toe kick screws.
- 9.20.3 Slide the toe kick towards the front of the tub until it comes off the mounting rails.
- 9.20.4 Refit in reverse manner.

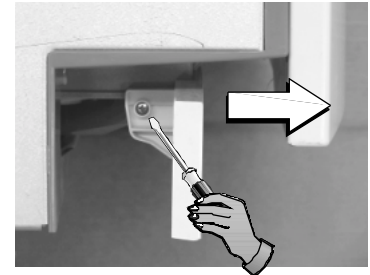

9.21 Lower Tub Cowling



- 9.21.1 Remove the lower drawer front as per instructions in 9.2.
- 9.21.2 Remove the toe kick as per instructions in 9.20.
- 9.21.3 Release the centre clip as shown and slide the cowling forward.
- 9.21.4 Refit in the reverse manner

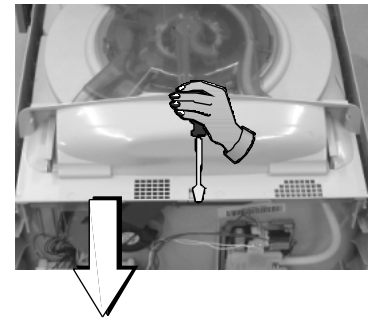

9.22 Front Trim Replacement



- 9.22.1 First remove both the left and right hand yokes as per instructions in 9.14. This is to prevent damaging the locating tab at the front of each yoke which fits into the trim.
- 9.22.2 The trim has to be removed by breaking the retaining clips.
- 9.22.3 This can be done by slipping a blade screwdriver between the trim and the chassis and twisting the blade to snap the clips. Protect the cabinet from chipping and remove the broken clips.
- 9.22.4 Remove the drawer front and handle as per instructions in 9.1 and 9.3 so the replacement trim can be fitted over the tub.
- 9.22.5 Line up the clips on the replacement trim with the holes in the chassis and push home.

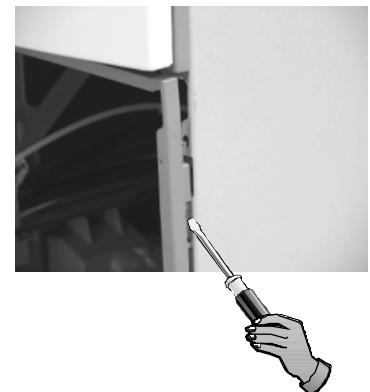

9.23 Water Softener



- 9.23.1 Remove the Drawer Front as per instruction 9.1
- 9.23.2 Disconnect the Wiring Loom connections to the Water Softener Diverter valve, Brine pump and Salt Level Detector and remove the Dispenser Wiring Loom connection to the Electronic Controller.
- 9.23.3 Use a flat bedded screwdriver to open the Salt Level Indicator LED cover and remove the LED from the Water Softener.
- 9.23.4 Unclip the Fill Hose and the Dispenser Hose from the Water Softener.
- 9.23.5 Remove the 4 T10 torx drive screws securing the Water Softener to the Tub
- 9.23.6 The Water Softener can now be removed from the Product
- 9.23.7 To refit, place the Overflow O'ring on the Water Softener and lubricate the Tub overflow with Glycerol or similar.
- 9.23.8 Place the Salt Tank O'ring in the tub. Lubricate the Salt Tank flange on the Water Softener.
- 9.23.9 Pass the Dispenser Wiring Loom through the Water Softener and plug it into the Electronic Controller.
- 9.23.10 Place the Water Softener in the Tub and apply enough pressure to seat the O'rings.
The Overflow should sit almost flush with the inside of the Tub.
The Salt Tank should be recessed by approx. 1mm from the inside of the Tub.
- 9.24.12 Refit in the reverse manner.

NOTES