

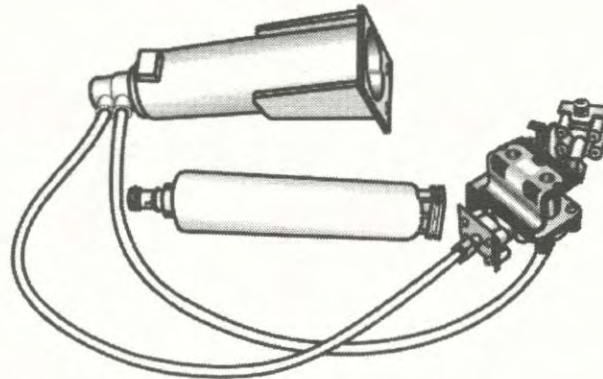

CONSUMER SERVICES TECHNICAL
EDUCATION GROUP PRESENTS

R-89



WATER FILTER SYSTEM for SIDE-BY-SIDE REFRIGERATOR/FREEZERS

JOB AID
Part No. 4322459

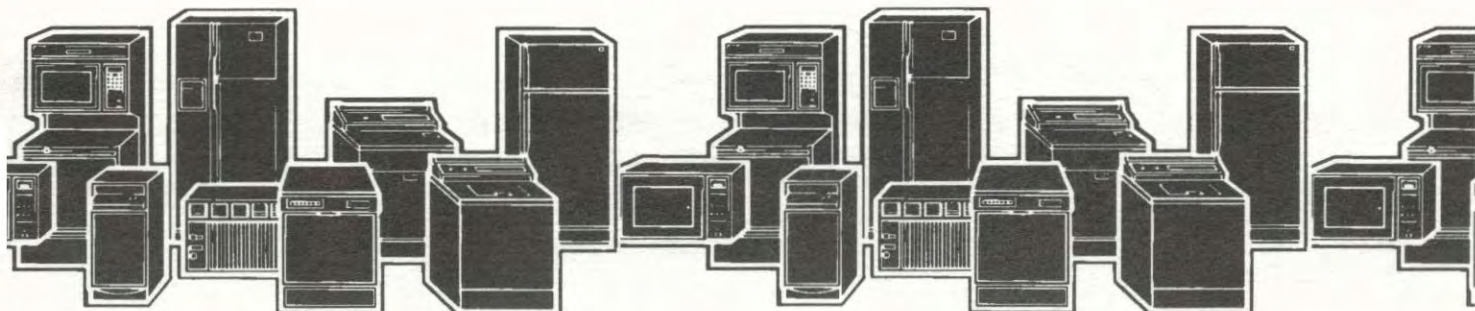

INTRODUCTION

This Job Aid, Water Filtration for Side-by-Side Refrigerator/Freezers, Part No. 4322459, provides the technician with information on servicing and troubleshooting the water filtration system introduced in 1998 for Whirlpool-built side-by-side refrigerators.

The water filtration system requires periodic replacement of the filter cartridge. As a result, this Job Aid covers those aspects of Customer *Use and Care* related to the replacement interval indicators and the proper procedures to follow to replace the filter cartridge.

For current information on the specific model and filtration system being serviced, refer to the *Tech Sheet* and the *Use and Care Guide* provided with the unit.

GOALS AND OBJECTIVES

The goal of this Job Aid is to provide detailed information on the theory of operation and service and maintenance of the water filtration system for side-by-side refrigerator/freezers that will enable the service technician to properly diagnose malfunctions, make effective repairs and instruct the customer in the proper procedures for replacing the filter cartridge.

The objectives of this Job Aid are to:

- Understand and follow proper safety procedures
- Identify the components of the water filtration system
- Troubleshoot and diagnose malfunctions
- Successfully perform necessary repairs
- Instruct the customer on proper procedures for replacing the filter cartridge



WHIRLPOOL CORPORATION ASSUMES NO RESPONSIBILITY
FOR ANY REPAIRS MADE ON OUR PRODUCTS BY ANYONE
OTHER THAN AUTHORIZED SERVICE TECHNICIANS.

TABLE OF CONTENTS

INTRODUCTION	II
TABLE OF CONTENTS	III
SAFETY	IV

Section One

THEORY OF OPERATION

Water Flow	1
Water Filter Monitoring System	1
Filter Specifications	2

Section Two

COMPONENT ACCESS

Component Location	3
Component Access	4
Filter Assembly	4
Water Supply Valves and Water Supply Connection	5
Replacing the Filter Cartridge	5
Accessing the Filter System Control Board	6

Section Three

TROUBLESHOOTING AND DIAGNOSIS

Troubleshooting	7
Component Testing	7
Diagnostic Routine	8

Section Four

TECH TIPS

Wiring Diagram	11
Cartridge Replacement Instructions	12

SAFETY



WARNING

ELECTRICAL SHOCK HAZARD

**Disconnect electrical power supply before testing any components.
Failure to do so could result in death or electrical shock.**

Section One

THEORY OF OPERATION

FILTER SYSTEM OPERATION

Water Flow

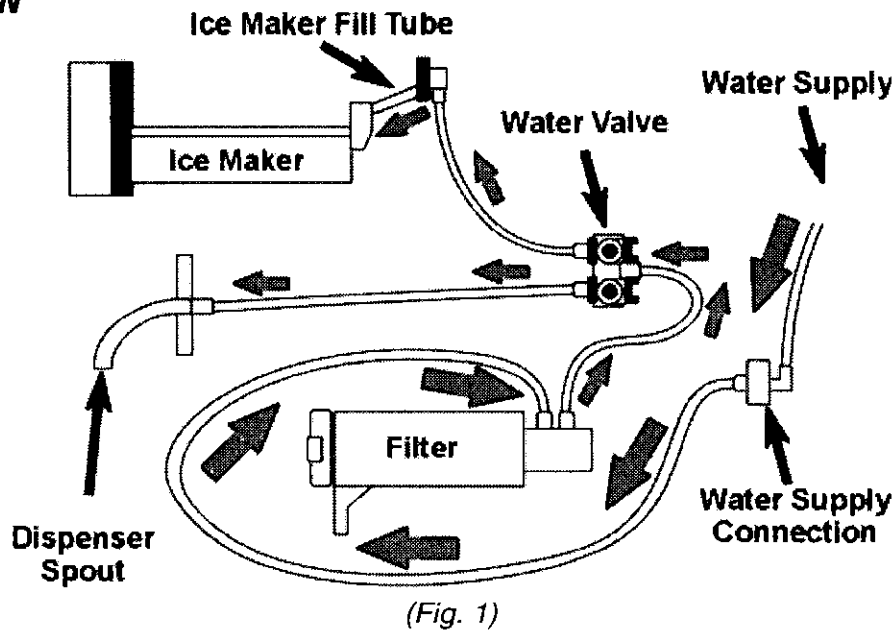

Water enters the filter system through the water supply connection at the lower right rear of the unit and is routed directly to the filter. (Fig. 1)

If the filter IS installed -

1. Water flows through the filter to the water valve assembly.
2. The water valve assembly sends water to the through-the-door water dispenser or automatic ice maker when called for.

If the filter IS NOT installed -

1. Water bypasses the filter and flows directly to the water valve assembly.
2. The water valve assembly sends water to the through-the-door water dispenser or automatic ice maker when called for.

Water Filter Monitoring System



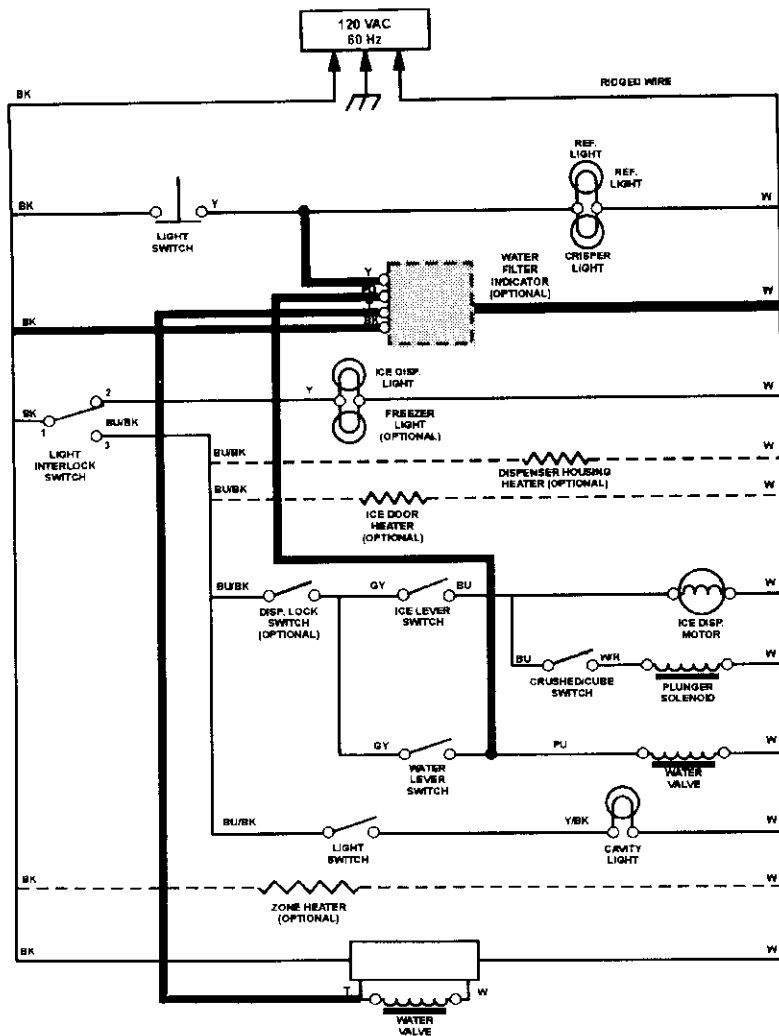

The water filter features a system monitoring circuit integrated into the electrical operation of the refrigerator/freezer. This monitoring system tells the user when it is time to replace the filter cartridge. A printed circuit board with an indicator light is located in the control box in the refrigerator compartment. (See wiring diagram, Fig. 2). The control board is powered whenever the unit is plugged in.

- The through-the-door water dispenser switch: This input tells the control board how long the water dispenser valve is on. Control board calculates volume of water based on flow rate of water valve and accumulated time.
- The ice maker fill valve: This input tells the control board how long the fill valve is on. Control board calculates volume of water based on flow rate of water valve and accumulated time.
- Indicator Light: Is GREEN until 11 months or 450 gallons, YELLOW between 11th and 12th month or 450 to 500 gallons and RED at the 12th month or 500 gallons.
- Light switch: The light switch is used to reset the control board once the system indicator LED shows RED, the sign that the filter must be changed.



(Fig. 2)

WIRING DIAGRAM KEY

-  = Water Filter Monitoring System
-  = Typical Refrigerator/Freezer Circuits
-  = Optional Refrigerator/Freezer Circuits
-  = Monitoring Circuit Control Board

WATER FILTER MONITORING SYSTEM KEY

- BK (black) = Power to Control Board
- P (purple) = Monitoring Water Dispenser Switch
- T (tan) = Monitoring Ice Maker Fill Valve
- Y (yellow) = Light Switch to Reset Control Board
- W (white) = Neutral

Filter Specifications

- 300 Gal. Max. NSF approval (non-indicator models)
- 500 Gal. Max. NSF approval (indicator models)
- Filter Cartridge Will Last One Year (normal water conditions)
- Granular Charcoal Filter (Filters lead, chlorine, taste and odor)
- John Guess Fittings on Filter Inlet and Outlet

Section Two

COMPONENT ACCESS

COMPONENT LOCATION

	<h2 style="margin: 0;">⚠ WARNING</h2> <p style="margin: 0;">ELECTRICAL SHOCK HAZARD</p> <p style="margin: 0;">Disconnect electrical power supply before servicing. Failure to do so could result in death or electrical shock.</p>
---	---

Control Panel

The Control Box (Fig. 3) contains the monitoring control board and indicator LED assembly (Fig. 4) and the reset button. The reset button (light switch) is mounted to the front panel of the control box.

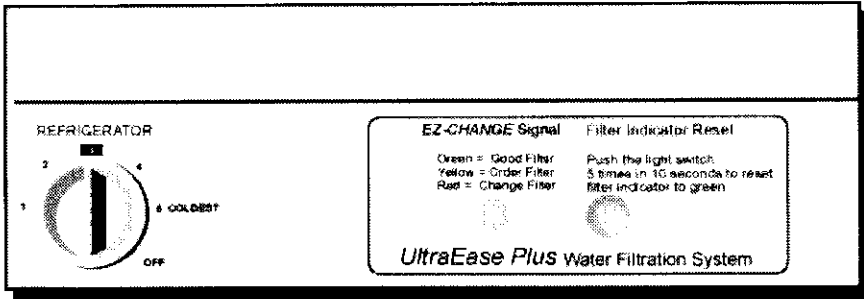

Fig. 3

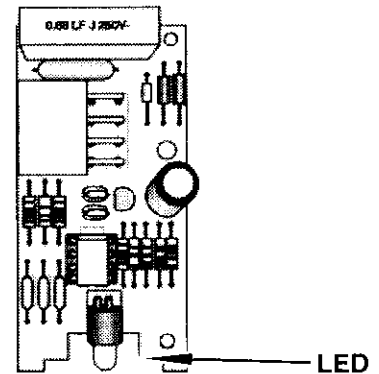

Fig. 4

Toe Panel

The Filter Assembly containing the filter cartridge is located behind the toe panel at the bottom of the freezer section. (Fig. 5)

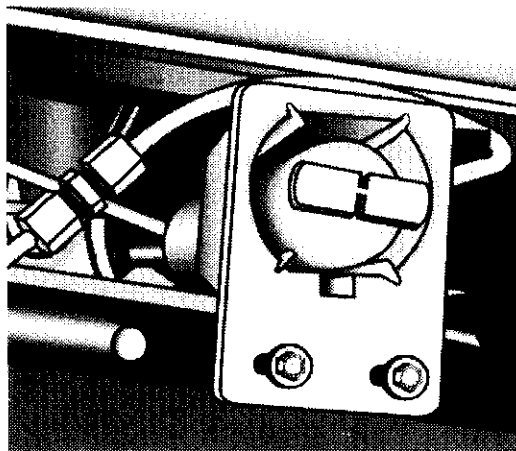

Fig. 5

Component Compartment

The water supply connection and the water supply valve are located at the lower right rear of the unit in the component compartment. (Fig. 6)

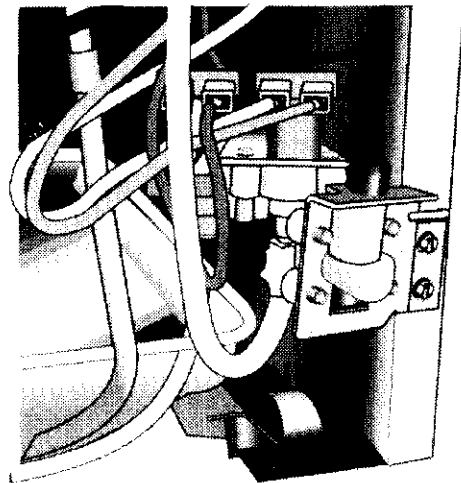

Fig. 6

COMPONENT ACCESS

Filter Assembly

The filter housing is located behind the toe panel, and is mounted to the bottom frame rail with two (2) Hex-head screws. (Fig. 7)

1. Shut off the water supply to the refrigerator.
2. Remove the filter cartridge by turning it counter-clockwise one-quarter turn and pulling it from the filter housing. This will close off the internal valves to reduce water spillage from the housing, when the filter cartridge is removed. A small amount of water will escape into the housing and then into the condensate pan.
3. Remove the two (2) Hex-head screws securing the filter housing to the bottom frame rail.
4. Pull the filter housing out from the refrigerator/freezer so that the water line connectors can be held over a pail.
5. Disconnect the water line connectors. (Fig. 8)

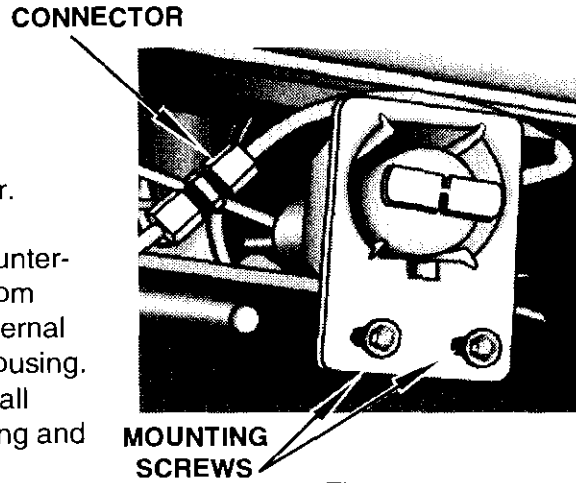

Fig. 7

NOTE: When reconnecting the water lines be sure to connect the water supply line to the filter inlet and the water outlet line to the outlet of the filter housing. (Fig. 8)

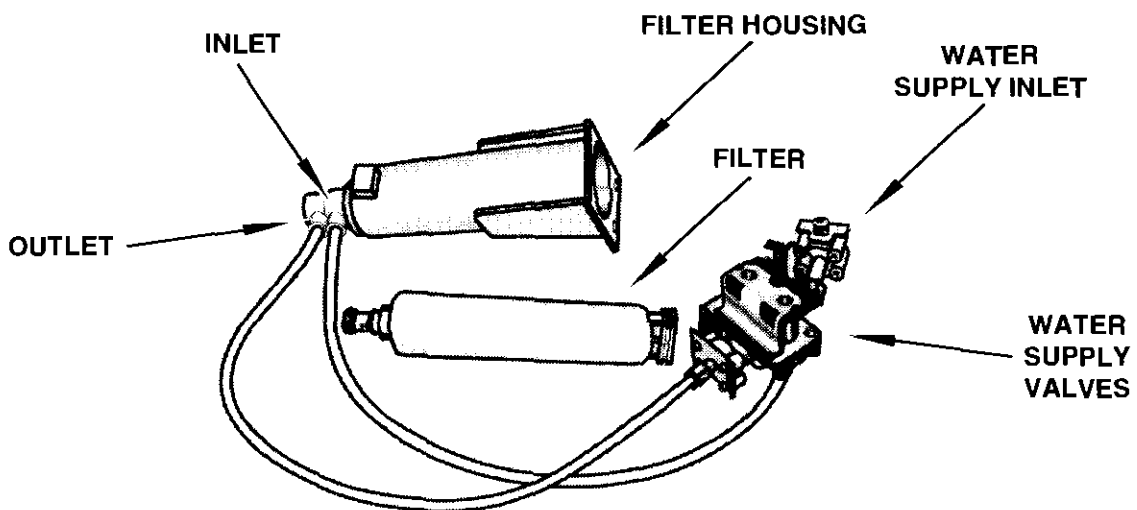

Fig. 8

Water Supply Valves and Water Supply Connection

The water supply connection to the refrigerator/freezer is mounted on a bracket that also contains the water dispenser and fill valve assembly. (fig. 9, INSET) This bracket is mounted to the rear of the refrigerator/freezer at the lower right of the component compartment with two (2) Hex-head screws. (Fig. 9)

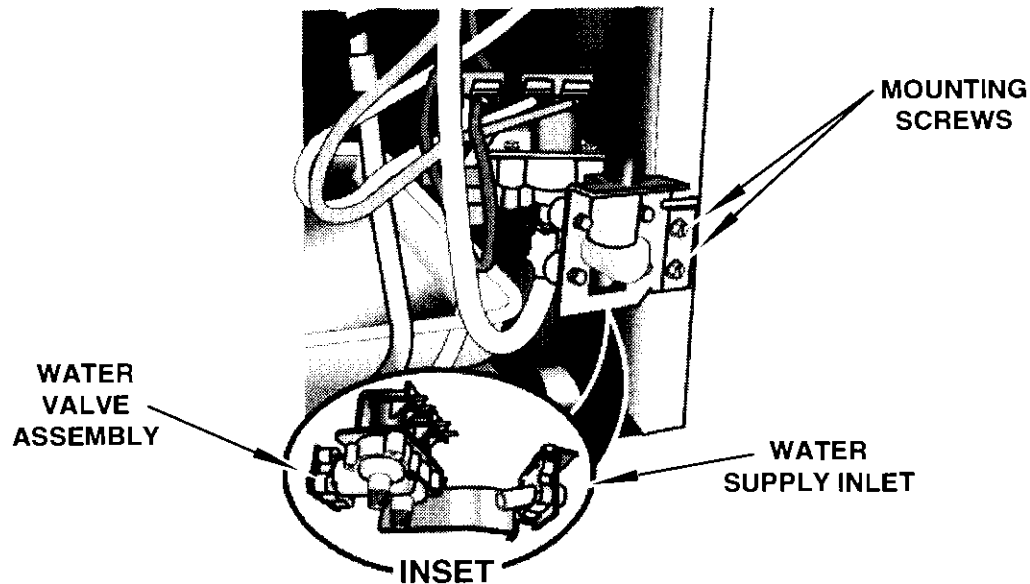

Fig. 9

1. Disconnect the power supply to the refrigerator/freezer.
2. Disconnect the wiring harness plug from the terminals on the water valve solenoids.
3. Shut off water supply to the the unit.
4. Disconnect the water line from the water supply connection. This water line may contain a small amount of water. Use a small pail to collect any water to protect the customer's floor.
5. Remove the two (2) Hex-head screws securing the bracket to the cabinet.
6. Disconnect the water lines from the water valves. These water lines may contain a small amount of water. Use a small pail to collect any water to protect the customer's floor.

Replacing the Filter Cartridge

The filter cartridge can be easily replaced from the front of the refrigerator/freezer.

1. Turn the handle on the filter cartridge one-quarter turn counterclockwise (Fig. 10) By doing so the water inlet and outlet are temporarily blocked. A small amount of water will escape from the cartridge when it is pulled out.
2. Pull the filter cartridge from the filter housing.
3. Remove the knob from the old filter cartridge and install it on the new one.
4. Replace the filter cartridge and thrun it one-quarter turn clockwise.



Fig. 10

- Run water through the dispenser until the water runs clear (at least one (1) gallon.) This will clean the system and clear air from the lines. Additional flushing may be required in some households. **NOTE:** As air is cleared from the system, water may spirt out the dispenser.

Accessing the Filter System Control Board

- Disconnect the refrigerator from the electrical supply.
- Pull knobs off of the control shafts (if present).
- Remove the escutcheon from the front of the control box. Insert a knife or small screwdriver behind the escutcheon from the top and pop the top out first.
- Remove the wiring cover at the top left inside of the refrigerator. (Fig. 11)
- Remove two hex screws at the back of the control box that secure it to the ceiling.
- Remove two hex screws at the sides on the front of the control box, and gently lower the control box a couple of inches.
- Disconnect the ground wire and two-wire harness connector and carefully swing the right side of the control box down. (Fig. 12) Be careful while lowering the control box not to bind or bend the damper control linkage.
- Remove the Indicator control board mounting screw and separate the board from the control box. (Fig. 13)
- Unplug the harness connector from the board. (Fig. 14)

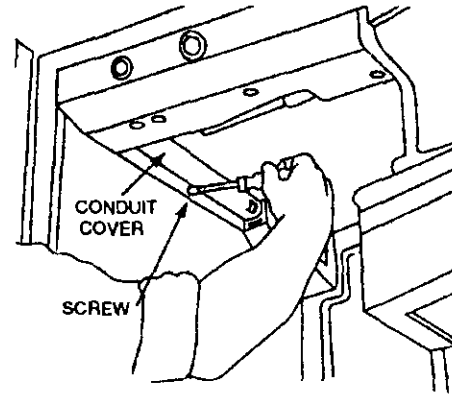

Fig. 11

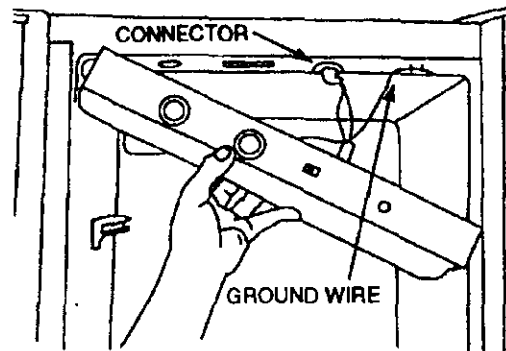
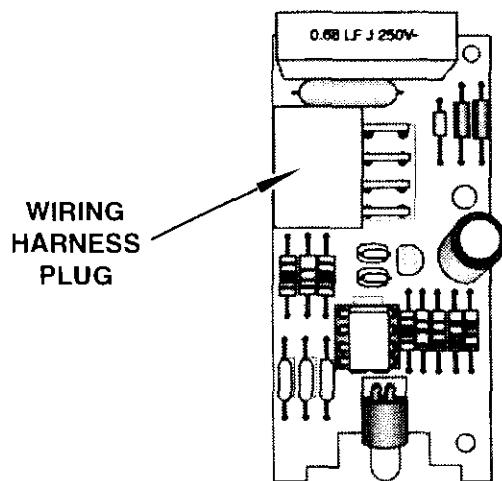
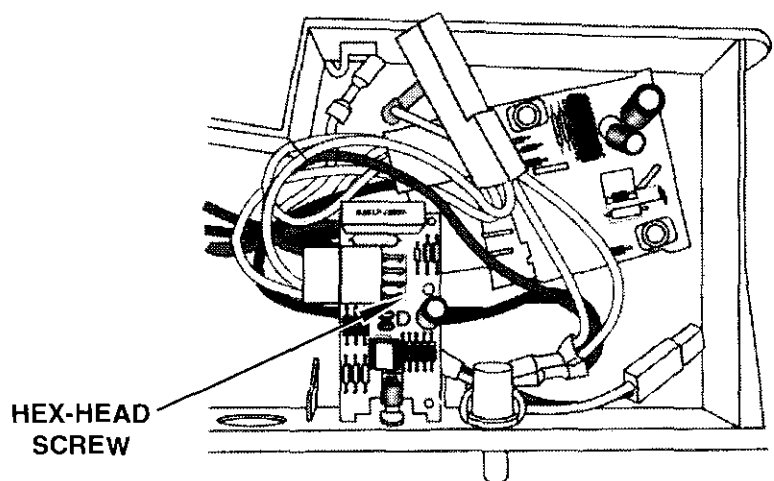

Fig. 12



A

Fig. 13



B

Fig. 14

Section Three

TROUBLESHOOTING AND DIAGNOSIS

TROUBLESHOOTING CHART

PROBLEM	CAUSE	PROCEDURE
Through-the-Door Water Dispenser Valve Operates but Little or No Water Dispenses	1.Filter cartridge is clogged. 2.Filter cartridge is improperly installed.	1.Replace filter cartridge. 2.Reinstall filter cartridge properly.
Ice Maker Fill Valve Operates but Little or No Water Appears at Ice Maker	1.Filter cartridge is clogged. 2.Filter cartridge is improperly installed.	1.Replace filter cartridge. 2.Reinstall filter cartridge properly.
Filter is Clogged but Indicator Light Shows GREEN	1.Indicator has been reset prematurely. 2.Severe water conditions exist and clogs filter prematurely.	1.Replace filter cartridge and reset indicator. 2.Replace filter cartridge and reset indicator.
Indicator light out	1.No power to control board. 2.LED on board malfunctioning.	1.Verify power to control board. 2.Replace control board.
Indicator light will not turn YELLOW or RED at appropriate times.	Control board clock malfunctioning.	Replace control board.
Indicator light will not reset to GREEN.	Control board malfunctioning.	Replace control board.

COMPONENT TESTING

	<h3 style="margin: 0;">⚠ WARNING</h3> <p style="margin: 0;">ELECTRICAL SHOCK HAZARD</p> <p style="margin: 0;">Disconnect electrical power supply before testing any components. Failure to do so could result in death or electrical shock.</p>
---	--

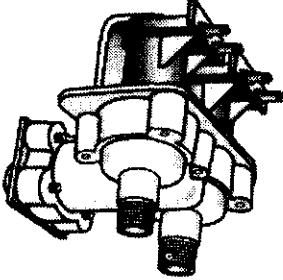
COMPONENT	PROBLEM	PROCEDURE
Water Valve Solenoids 	1.Water dispenser solenoid does not operate when the through-the-door dispenser switch is closed.	1. a. Set the Ohmmeter scale to Rx1. Place the probes on the terminals of the solenoid. Meter should read approximately 960 ohms. b. Push water dispenser and check for 120VAC at the water valve.
	2.Ice maker fill valve solenoid does not operate when the ice maker is cycled through a fill cycle.	2. a. Set the Ohmmeter scale to Rx1. Place the probes on the terminals of the solenoid. Meter should read approximately 960 ohms. b. Cycle the ice maker and check for 120VAC at the water valve.

DIAGNOSTIC ROUTINE

The integrity of the filter system control board can be tested by performing the following diagnostic routines. (See wiring diagram on page 9)

INPUT TEST	PROCEDURE	OUTCOME
Through-the-Door Water Dispenser Valve	Hold down the light switch and activate the through-the-door water dispenser switch.	Indicator light turns GREEN - verifies input to control board (Purple wire)
Ice Maker Fill Valve	Hold down the light switch and Cycle the Ice Maker to activate the fill valve.	Indicator light turns RED - verifies input to control board (Tan wire)
Both Water Dispenser Valve and Ice Maker Fill Valve	Hold down the light switch and Activate both valves at the same time	Indicator light turns YELLOW

If any of these tests fail, perform the following voltage check:

1. Verify voltage input to the control board. (120VAC between BK and W)
2. Verify voltage input to the control board. (120VAC between Y and W) **NOTE:** Interior lights must be on.
3. Verify voltage input to the control board. (120VAC between PU and W) **NOTE:** Depress dispenser switch for this test.)
4. Verify voltage input to the control board. (120VAC between T and W) **NOTE:** Cycle ice maker to fill mode for this test.

If voltage check are confirmed, then the control board must be replaced.

Power Interruption

If the power is interrupted to the refrigerator/freezer or if the unit is unplugged for service-

1. When power is restored to the unit the indicator light will flash RED 5 times and then display the color indicating the condition of the filter cartridge.
2. A power interruption will not erase the control board's memory of the current condition of the filter cartridge.

Resetting the Filter Indicator

Resetting the filter indicator will cause the indicator light to flash RED 3 times and then show GREEN.

Section Four

TECH TIPS

Wiring Diagram

(Water Filter System Circuitry Highlighted)

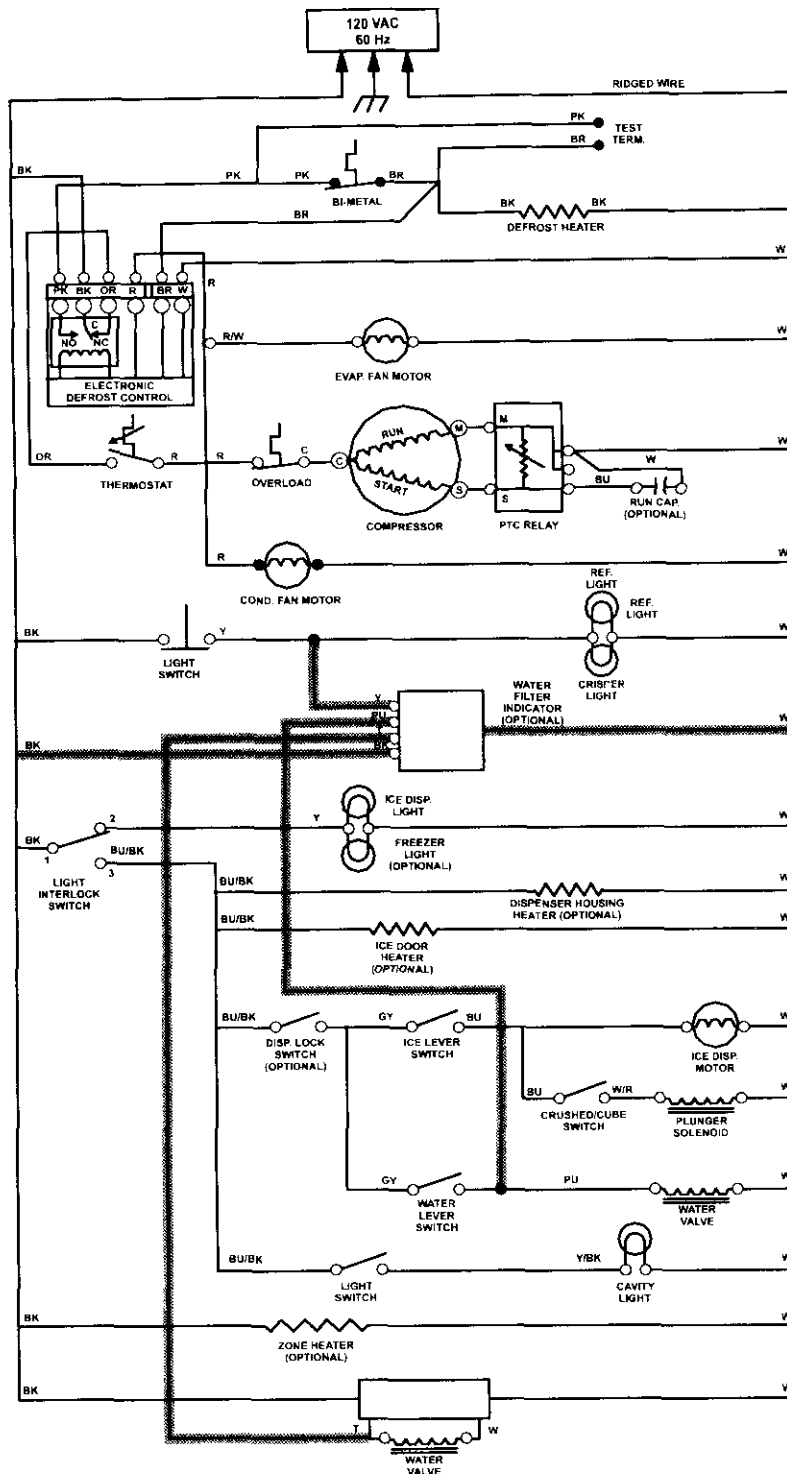



NOTE: Wiring diagram displayed here is intended to show a typical configuration. Units with Water Filter Systems may have Adaptive Defrost Control or a Standard Electro-mechanical Defrost Timer Circuit. Refer to the Tech Sheet provided with the specific unit being serviced.

Whirlpool* ULTRAEASE* Plus Water Filtration System

The water filter indicator light (on some models)

The water filter indicator light will help you know when to change your water filter cartridge. The light is located at the inside top of the refrigerator compartment. The light will change from green to yellow. This tells you that it is almost time to change the water filter cartridge (90% of the filter life has been used.) It is recommended that you replace the water filter cartridge when the water filter indicator light changes to red OR water flow to your water dispenser or ice maker decreases noticeably. (See "Changing a water filter cartridge" later in this section.)

NOTE: Do not use with water that is microbiologically unsafe or of unknown quality without adequate disinfection before or after the system.

<i>EZ-CHANGE</i> Signal	Filter Indicator Reset
Green = Good Filter	Push the light switch 5 times in 10 seconds to reset filter indicator to green
Yellow = Order Filter	
Red = Change Filter	
	

UltraEase Plus Water Filtration System

After changing the water filter cartridge, reset the water filter indicator light by pressing the light switch 5 times within 10 seconds. The status light will change from red to green when the system is reset.

Non-indicator models

If your refrigerator does not have the water filter indicator light, you should change the water filter cartridge every 6-9 months depending upon your usage. If the water flow to the water dispenser or ice maker decreases noticeably before 6 months have passed, replace the water filter cartridge more often. (See "Changing a water filter cartridge" later in this section.)

Changing a water filter cartridge

The water filter is located below the freezer compartment door.

1. Locate the water filter cartridge cap in the front base grille below the freezer compartment door. Rotate the cap counterclockwise to a vertical position and pull the cap and filter cartridge out through the base grille.

NOTE: There will be water in the cartridge. Some spilling may occur.



2. Remove the cartridge cap by sliding it off the end of the old cartridge. The cap will slide to the left or right. **DO NOT DISCARD THE CAP.**

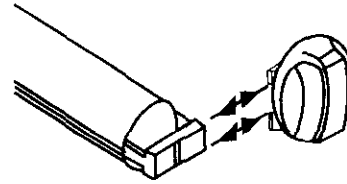

3. Take the new cartridge out of its packaging and remove protective cover from O-rings.

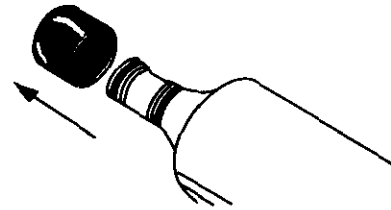

4. Slide the cartridge cap onto the new cartridge as shown.

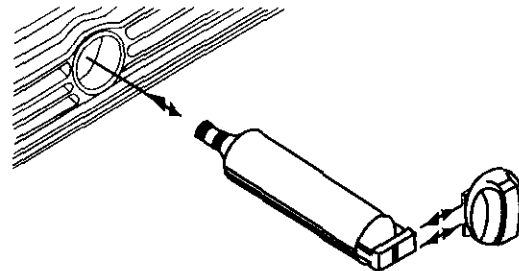

5. With cartridge cap in the vertical position, push the new filter cartridge into the base grille until it stops. Rotate the cartridge cap clockwise to a horizontal position.



6. **RUN WATER THROUGH THE DISPENSER UNTIL THE WATER RUNS CLEAR (AT LEAST ONE GALLON.)** This will clean the system and clear air from lines. Additional flushing may be required in some households.

NOTE: As air is cleared from the system, water may spurt out of the dispenser.

Using the dispenser without the water filter

You can run the dispenser without a water filter cartridge. Your water will not be filtered. If you run the dispenser without a water filter cartridge, keep the cartridge cap and replace it in the base grille for future use.

1. Remove the water filter cartridge. (See “changing a water filter cartridge” earlier in this section.) Then slide the cartridge cap off the end of the filter cartridge. **DO NOT DISCARD THE CAP.**
2. With the cartridge cap in the vertical position, insert the cap into the base grille until it stops.

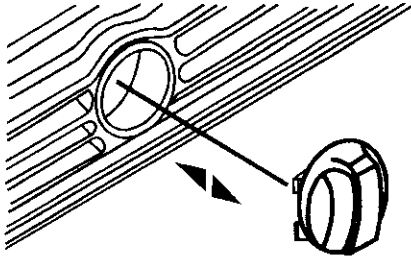

3. Rotate the cartridge cap to a horizontal position.

NOTE: The cartridge cap may not be even with the base grille.

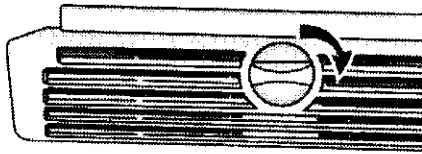

Ordering replacement filters

To order more water filter cartridges, call 1-800-442-9991. When replacing your factory-installed water filter, ask for accessory Part #4392857.

BRANDS AND MODELS

KitchenAid

- KSRS (Superba) - Filter System with Indicators
- Middle Line Models - Filter system Only

Whirlpool

- Gold Series - Filter System with Indicators
- R Models - Filter System Only

