



ELECTROLUX HOME PRODUCTS NORTH AMERICA

SERVICE MANUAL

Tumble Action Washers

With

AC Drive motor

Frigidaire

TAPPAN

W White-Westinghouse

Gibson

Kelvinator 

5995369211

July 2002

SAFE SERVICING PRACTICES - ALL APPLIANCES

To avoid personal injury and/or property damage, it is important that **Safe Servicing Practices** be observed. The following are some limited examples of safe practices:

1. **DO NOT** attempt a product repair if you have any doubts as to your ability to complete it in a safe and satisfactory manner.
2. Before servicing or moving an appliance:
 - Remove the power cord from the electrical outlet, trip the circuit breaker to the OFF position, or remove the fuse.
 - Turn off the gas supply.
 - Turn off the water supply.
3. Never interfere with the proper operation of any safety device.
4. **USE ONLY REPLACEMENT PARTS CATALOGED FOR THIS APPLIANCE. SUBSTITUTIONS MAY DEFEAT COMPLIANCE WITH SAFETY STANDARDS SET FOR HOME APPLIANCES.**
5. **GROUNDING:** The standard color coding for safety ground wires is **GREEN**, or **GREEN** with **YELLOW STRIPES**. Ground leads are not to be used as current carrying conductors. It is **EXTREMELY** important that the service technician reestablish all safety grounds prior to completion of service. Failure to do so will create a hazard.
6. Prior to returning the product to service, ensure that:
 - All electrical connections are correct and secure
 - All electrical leads are properly dressed and secured away from sharp edges, high-temperature components, and moving parts
 - All non-insulated electrical terminals, connectors, heaters, etc. are adequately spaced away from all metal parts and panels
 - All safety grounds (both internal and external) are correctly and securely connected
 - All panels are properly and securely reassembled

ATTENTION!!!

This service manual is intended for use by persons having electrical and mechanical training and a level of knowledge of these subjects generally considered acceptable in the appliance repair trade. Electrolux Home Products cannot be responsible, nor assume any liability, for injury or damage of any kind arising from the use of this manual.

SAFE SERVICING PRACTICES	2
QUICK REFERENCE SHEET	7
Serial nameplate location	7
Serial number breakdown	7
Tech sheet location	7
Component resistance chart	8
Water fill height	8
Electrical requirements	8
Incoming water pressure	8
Drain requirements	8
Motor	8
Operation speeds	9
Tub pulley to motor pulley ratio	9
Tub capacity	9
Auto temp control temperature specifications	9
SAMPLE SCHEMATIC	10
SECTION A - INSTALLATION INSTRUCTIONS	11
Full size tumble action washer	11
What to do if you smell gas	11
Pre-installation requirements	11
Tools required for installation	11
Electrical requirements	11
Circuit	11
Power supply	11
Outlet receptacle	11
Grounding requirements	11
Water supply requirements	12
Drain requirements	12
Rough-in dimensions	13
Under counter installation	13
Location of your washer	14
Improper locations	14
Minimum installation clearances	14
Unpacking	14
Installation	15
Replacement parts	16
SECTION B - OPERATING INSTRUCTIONS	17
Before operating your washer	17
Operating steps	17
Cycle selection	17
Whites/regular cycle	17
Short wash cycle	18
Colors/perm press cycle	18
Knits and delicates cycle	18
Controls	18
Temperatures	18
Cycle signal	18
Indicator lights	18
Auto temp control	18
Extra rinse	18
Final spin	18
SECTION C - OWNER'S GUIDE	20
Sample warranty	20
Product registration	21
Record your model and serial numbers	21
Register your product	21
Important safety instructions	21

Read all instructions before using this washer	21
Prevent fire	21
Protect Children	21
Prevent Injury	22
Washing procedures	23
Sort laundry into loads that can be washed together	23
Prepare items for washing	23
Pretreat stains and heavy soil	24
Add laundry load to washer	24
Add detergent, bleach and fabric softener to automatic dispenser	24
Set cycle selector knob and washer controls according to type, size, and soil level of each load	25
Start the washer	25
Remove items when the cycle is completed	26
General precautions	26
Stain removal	26
Safe stain removal procedures	26
Stain removal	27
Common washing problems	28
Care and cleaning	29
Outside	29
Cleaning the dispenser drawer area	29
Inside	30
Avoid service checklist	30
Winterizing instructions	30
Service information (Canada)	33
Sample warranty (Canada)	34
SECTION D - OPERATION	35
Timer	35
Line Switch	35
Dispenser Drawer Reed Switch	35
Door Switch Assembly	36
Pressure Switch	37
Automatic Dispenser	37
Temperature	39
Auto Temp System	39
Water Inlet Valve	40
Extra Rinse Switch	41
Drain Pump	41
End of Cycle Signal Switch	42
End of Cycle Signal	42
Speed Control	42
Speed Switch (some models)	43
Motor	43
SECTION E - CONSTRUCTION	44
Cabinet	44
Front Panel and Door Assembly	44
Bellows (Door Boot)	44
Outer Tub Assembly	44
Spin Basket Assembly	44
SECTION F - TROUBLESHOOTING FLOW CHARTS	45
Motor and speed control plug numbers	46
Washer completely inoperative	47
Timer does not advance	47
Washer does not drain	48
Extra rinse setting does not work	48
Bleach dispenser does not operate	49

Softener dispenser does not operate	49
Drive motor does not turn	50
Drive motor spins but does not tumble	51
Drive motor tumbles but does not spin	51
Drive motor tumbles very slowly in any timer position	52
Models with normal and fast speed switch spinning at incorrect speed for switch setting	52
Models with slow, normal and fast speed switch spinning at incorrect speed for switch setting	53
Water fill does not turn off	54
Incorrect water level	54
Slow water fill	55
Water will not fill in setting of the temp switch	56
Washer will not fill in wash cycle, but will fill in rinse with the temp switch set to cold/cold	57
Washer will only fill with cold water in the wash cycle, with the temp switch set to warm/cold	57
Water temperature is too hot or too cold in the wash cycle with the temp switch set to warm/warm	58
Washer will only fill with hot water in the wash cycle, with the temp switch set to warm/cold but does fill with cold in the rinse cycle	58
Auto temp control does not control the wash water temperature within specification	59
Door indicator lamp does not glow	59
Indicator lamp (wash, rinse, or final spin) does not glow	60
SECTION G - TEARDOWN	61
Removing the detergent drawer	61
Detergent drawer disassembly	61
Removing the knobs	62
Removing timer bezel	62
Removing rear panel of the console (top console models)	62
Removing the top panel (front console models)	62
Removing the top panel (top console models)	63
Removing the console (top console models)	63
Removing the console skirt (top console models)	63
Removing the front panel from the console (top console models)	64
Removing the indicator lamp assembly (top console models)	64
Removing the indicator lamp assembly (front console models)	64
Removing the end caps (top console models)	64
Removing the timer (top console models)	65
Removing the timer (front console models)	65
Removing the extra rinse or final rinse switch (front control models)	65
Removing the extra rinse, final spin speed, or end of cycle chime switch (top console models)	65
Removing the control panel (front console models)	66
Removing the front panel (top console models)	67
Removing the end of chime switch (front console models)	67
Removing the reed switch (front console models)	68
Removing the buzzer (front console models)	68
Removing the buzzer (top console models)	68
Removing the act temp switch (front console models)	68
Removing the act temp switch (top console models)	69
Removing the front service panel	69
To remove loading door or door glass	69
To remove door strike	70
To remove door hinge	70
Removing the door safety switch	71

Removing the boot _____	71
Reinstalling or replacing the boot _____	73
Removing the detergent dispenser solenoid assembly _____	75
Removing the detergent cavity assembly _____	76
Removing the pressure switch _____	77
Removing the suspension springs _____	77
Removing the automatic temperature control board _____	77
Removing the automatic temperature control sensor _____	78
Removing the water inlet valve _____	78
Removing the drain pump assembly _____	78
Disassembling the drain pump _____	79
To remove the air bell _____	79
Removing the back service panel _____	80
Removing the speed control board assembly _____	80
Drive belt _____	81
To remove or replace the drive belt _____	81
Removing the drive motor _____	81
Removing the large pulley _____	81
Removing the rear counter weight _____	81
Removing the air shock absorber _____	81
Removing the outer tub _____	82
Removing the spin basket and rear tub half _____	82
Removing the front counter weights _____	83
Removing the spin basket vanes _____	83

QUICK REFERENCE SHEET

1. Serial nameplate location:

On the front panel at the top center of the washer door opening.



2. Serial number breakdown.

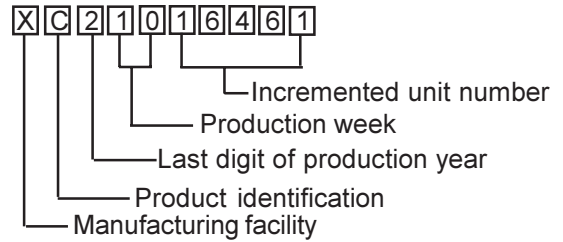

3. Tech sheet location

On the lefthand bodyside behind the front access panel.



QUICK REFERENCE SHEET

Component resistance chart.

Electrical component		Resistance Ω @ 77° F (25°C)
Water valve solenoids		880 \pm 10%
Door lock solenoid		380 \pm 10%
Timer motor		2425 \pm 6%
Pump motor		15 \pm 7%
Dispenser valve solenoids		1100 \pm 7%
Motor	M1 TO M2	2.6 \pm 7%
	M2 TO M3	2.6 \pm 7%
	M1 TO M3	2.6 \pm 7%
	M5 TO M6	184 \pm 7%
ATC		50K \pm 2%

Water fill height 4 5/8 \pm 3/8 IN. (11.75 \pm 0.95 CM)
No load, start position of permanent press cycle.

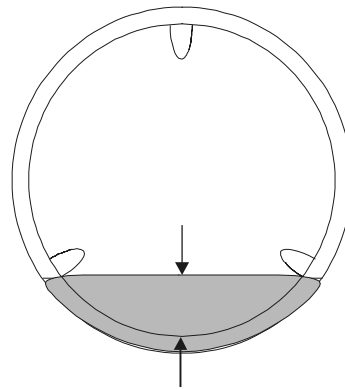

Electrical requirements.

Circuit - Individual, properly polarized and grounded
15 amp. branch circuit fused with 15 amp. time delay
fuse or circuit breaker.

Incoming water pressure.

30 and 120 pounds per square inch (maximum
unbalance pressure, hot vs. cold, 10 psi.)

Drain requirements.

Drain capable of eliminating 17 gals (64.3 L) per minute.

A standpipe diameter of 1-1/4 in. (3.18 cm) minimum.

The standpipe height above the floor should be:

Minimum height: 24 in. (61 cm)

Maximum height: 96 in. (244 cm)

Motor.

Agitate wattage - Max 200

Spin wattage - Max 475

Operation speeds:

Agitate Speed - RPM (Regular/Perm Press)	51 ± 4
Agitate Speed - RPM (Knits/Delicates/Hand Washables)	35 ± 4

Spin speeds	No speed sw.	Two terminal speed sw.	Three terminal speed sw.
Regular Cycle			
Spin Speed R.P.M. (Slow)	NA	NA	850 ± 35
Spin Speed R.P.M. (Normal)	NA	900 ± 39	900 ± 39
Spin Speed R.P.M. (Fast)	850 ± 39	950 ± 39	950 ± 39
Perm Press Cycle			
Spin Speed R.P.M. (Slow)	NA	NA	650 ± 30
Spin Speed R.P.M. (Normal)	NA	650 ± 39	650 ± 30
Spin Speed R.P.M. (Fast)	650 ± 39	900 ± 39	950 ± 39
Knits/Delicates/Hand Washables Cycle			
Spin Speed R.P.M. (Slow)	NA	NA	450 ± 25
Spin Speed R.P.M. (Normal)	NA	450 ± 25	450 ± 25
Spin Speed R.P.M. (Fast)	450 ± 25	650 ± 30	650 ± 30

Tub Pulley to Motor Pulley Ratio	16 TO 1
Tub Capacity	2.65 cu. ft.
Automatic Temperature Control Specifications	
Regulated warm/warm and warm /cold settings	98° ± 7° F
Regulated cold/cold settings	66° ± 7° F

SAMPLE SCHEMATIC

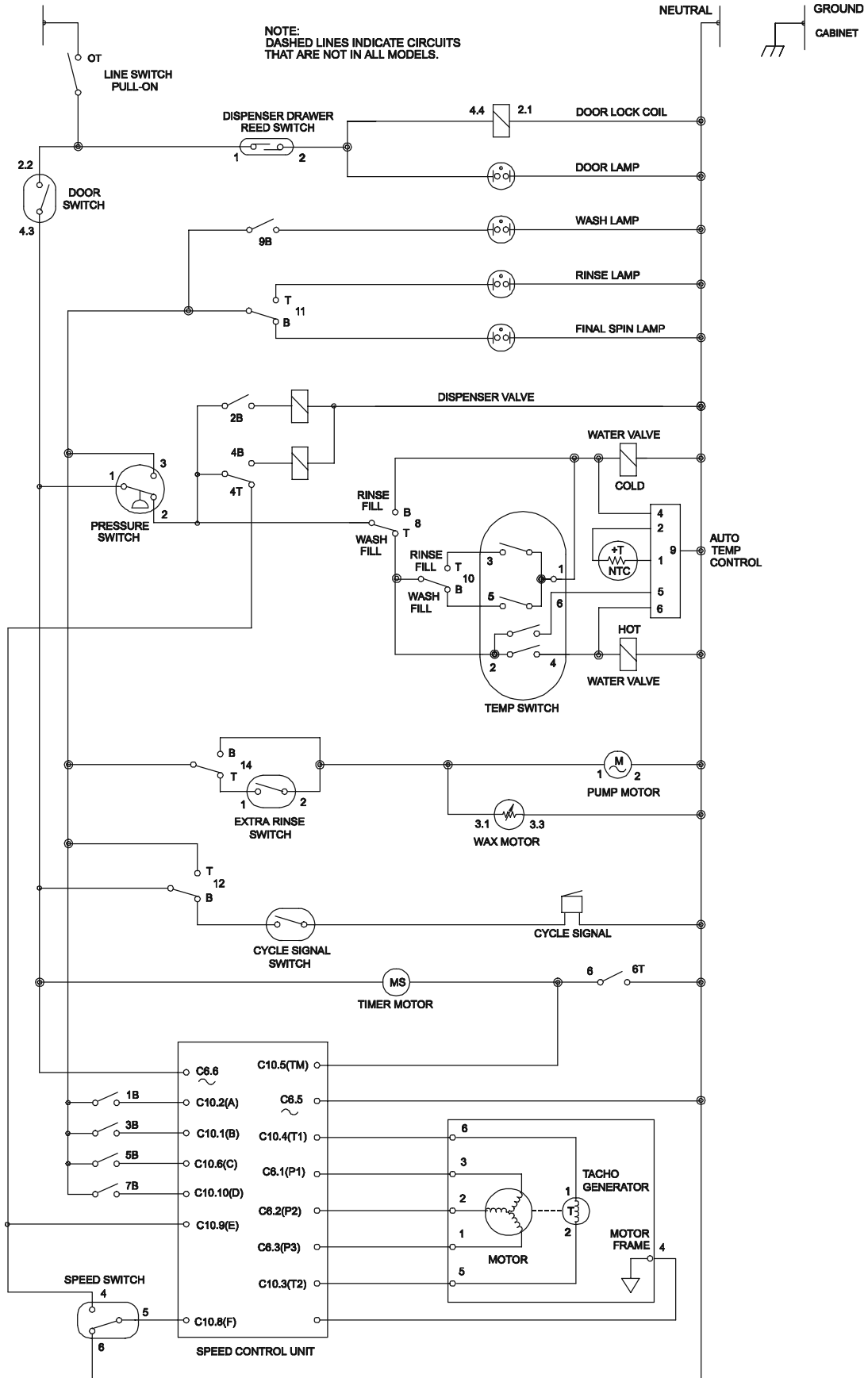

Section A - Installation Instructions

Full Size Tumble Action Washers

Before beginning installation, carefully read these instructions. This will simplify the installation and ensure the washer is installed correctly and safely. Leave these instructions near the washer after installation for future reference.

NOTE: The electrical service to the washer must conform with local codes and ordinances and the latest edition of the National Electrical Code, ANSI/NFPA 70 or in Canada, CSA C22.1 Canadian Electrical Code Part 1.

⚠ WARNING For your safety the information in this manual must be followed to minimize the risk of fire or explosion or to prevent property damage, personal injury or loss of life.

- Do not store or use gasoline or other flammable vapors and liquid in the vicinity of this or any other appliance.

- WHAT TO DO IF YOU SMELL GAS

- Do not try to light any appliance.
- Do not touch any electrical switch; do not use any phone in your building.
- Clear the room, building or area of all occupants.
- Immediately call your gas supplier from a neighbor's phone. Follow the gas suppliers instructions.
- If you cannot reach your gas supplier, call the fire department.

Installation and service must be performed by a qualified installer, service agency or the gas supplier.

PRE-INSTALLATION REQUIREMENTS

Tools Required for Installation:

1. 1/4 in. nut driver.
2. 3/8 in. socket with ratchet.
3. 3/8 in. open end wrench.
4. 7/16 in. socket with ratchet.

5. 9/16 in. open end wrench.
6. Channel-lock adjustable pliers.
7. Carpenter's level.

ELECTRICAL REQUIREMENTS

CIRCUIT - Individual, properly polarized and grounded 15 amp. branch circuit fused with 15 amp. time delay fuse or circuit breaker.

POWER SUPPLY - 2 wire, with ground, 120 volt, single phase, 60 Hz, Alternating Current.

OUTLET RECEPTACLE - Properly grounded 3-prong receptacle to be located so the power supply cord is accessible when the washer is in an installed position.

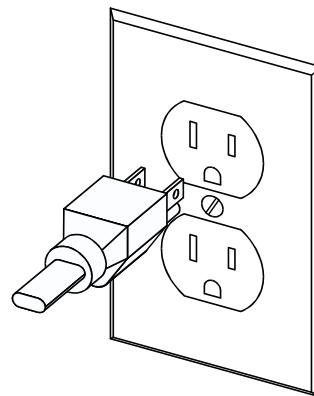

GROUNDING REQUIREMENTS

⚠ WARNING Improper connection of the equipment grounding conductor can result in a risk of electrical shock. Check with a licensed electrician if you are in doubt as to whether the appliance is properly grounded.

1. The washer **MUST** be grounded. In the event of malfunction or breakdown, grounding will reduce the risk of electrical shock by a path of least resistance for electrical current.
2. Since your washer is equipped with a power supply cord having an equipment-grounding conductor and a grounding plug, the plug **MUST** be plugged into an appropriate, copper wired receptacle that is properly installed and grounded in accordance with all local codes and ordinances or in the absence of local codes, with the National Electrical Codes, ANSI/NFPA 70 (latest edition). If in doubt, call a licensed electrician. **DO NOT** cut off or alter the grounding prong on the power supply cord. In

situations where a two-slot receptacle is present, it is the owner's responsibility to have a licensed electrician replace it with a **properly grounded** three prong grounding type receptacle.

authorized parts distributor. If drain is less than 24 in. (61 cm), install a siphon break kit, available at your local hardware store.

WATER SUPPLY REQUIREMENTS

Hot and cold water faucets **MUST** be installed within 42 inches (107 cm) of your washer's water inlet. The faucets **MUST** be 3/4 inch (1.9 cm) garden hose type so inlet hoses can be connected. Water pressure **MUST** be between 30 and 120 pounds per square inch (maximum unbalance pressure, hot vs. cold, 10 psi.) Your water department can advise you of your water pressure. The hot water temperature should be about 140 degrees F (60 degrees C).

DRAIN REQUIREMENTS

1. Drain capable of eliminating 17 gals (64.3 L) per minute.
2. A standpipe diameter of 1-1/4 in. (3.18 cm) minimum.
3. The standpipe height above the floor should be:
Minimum height: 24 in. (61 cm)
Maximum height: 96 in. (244 cm)

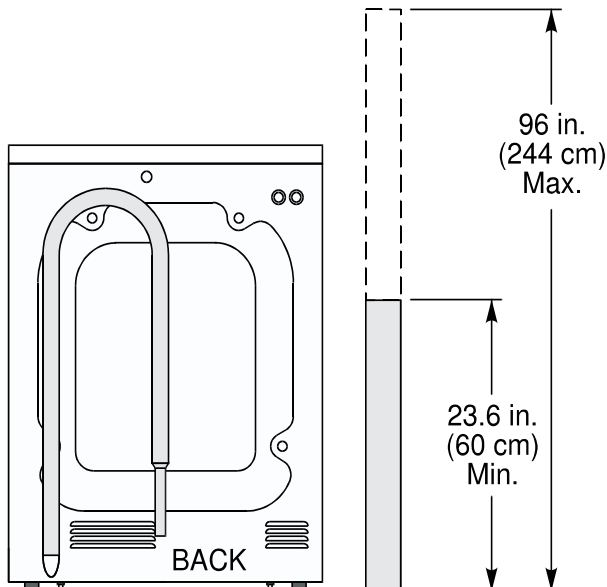

NOTE:

Drain hose attached to the washer can reach a 58 in. (147 cm) high standpipe. For higher standpipe use hose P/N 131461201, available from an

ROUGH-IN DIMENSIONS

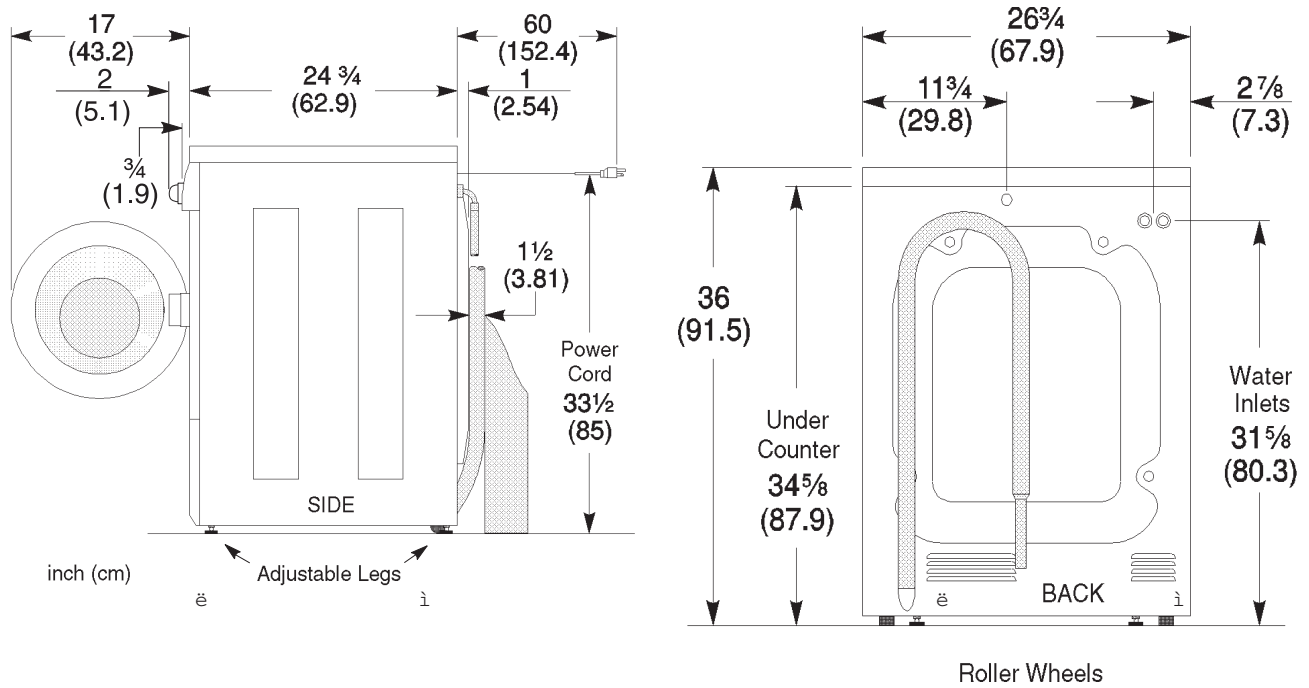

UNDER COUNTER INSTALLATION

If an under counter* installation is desired, the washer **MUST** have a top sheet kit installed, P/N 131445600. Kit is available from an authorized parts distributor.

*Custom sized countertop is required.

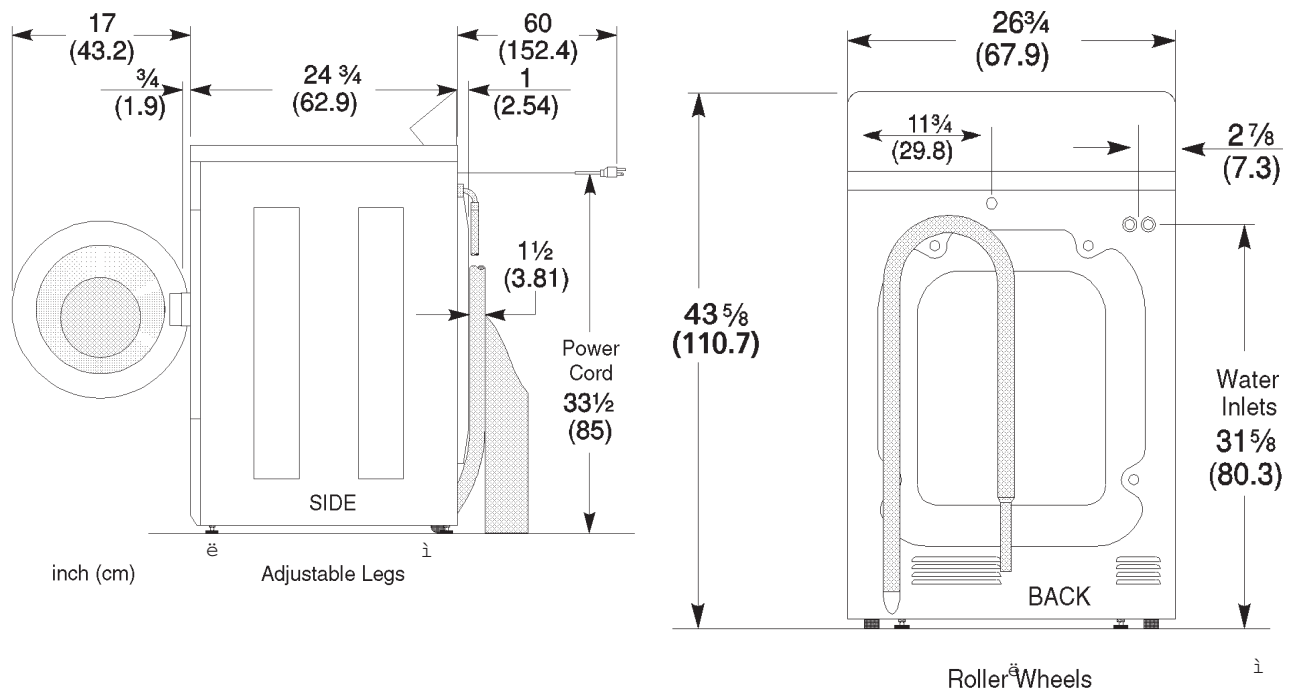

LOCATION OF YOUR WASHER

DO NOT INSTALL YOUR WASHER:

1. In an area exposed to dripping water or outside weather conditions. The ambient temperature should never be below 60 degrees F (15.6 degrees C) for proper washer operation.
2. In an area where it will come in contact with curtains or drapes.
3. In an area (garage or garage-type building) where gasoline or other flammables are kept or stored (including automobiles).
4. On carpet. Floor **MUST** be solid with a maximum slope of 1/2 in. per foot (1.27 cm per 30.5 cm). To ensure vibration or movement does not occur, reinforcement of the floor may be necessary.

IMPORTANT MINIMUM INSTALLATION CLEARANCES

When installed in alcove or closet:

Sides, Rear = 0 in. (0 cm)

Top = 0 in. (0 cm) **Front Console Model**

Top = 15 in. (38.1 cm) **Rear Console Model**

When installed in closet: Front = 1 in. (2.54 cm)

Closet door ventilation required: 2 louvered openings each 60 in² (387 cm²), 3 in. (7.6 cm) from top and bottom of door.

UNPACKING

1. Cut the shipping carton along the dotted line along the base of the unit.

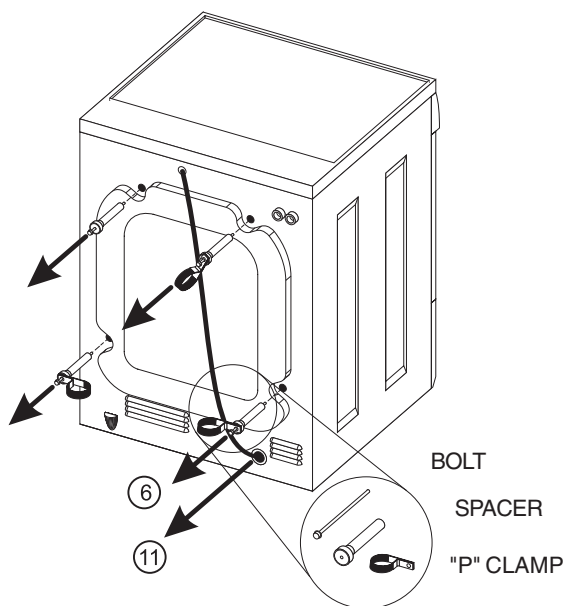

2. While in the carton carefully lay the washer on its back side.
3. Remove the styrofoam base.
4. Carefully return the washer to an upright position and remove the carton.
5. Carefully move the washer to within 4 feet (122cm) of the final location.
6. Remove the following from the back side of the washer: 4 bolts, 4 yellow plastic spacers, 3 metal "P" clamps.
7. Remove the service panel from the front of the washer.
8. Remove the 4 nuts and 6 large washers that attach the 2 yellow shipping braces to the drum and the base. Lift up on the drum and remove the braces (a yellow ribbon surrounds the items to be removed). These braces must be removed to allow the power supply cord to be released from the shipping ring.
9. Remove the large styrofoam block located under the drum. Lift up on the drum, tilt the base of the foam block inwards toward the rear of the washer until free, then pull it out.
10. Remove and discard the yellow ribbon and label from the front of the washer.

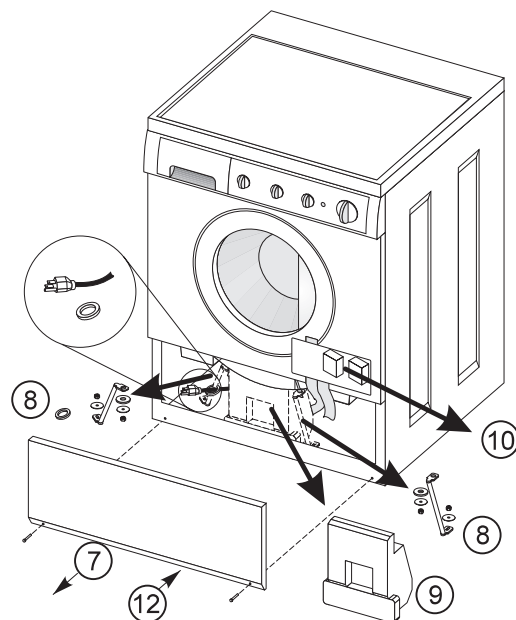

11. From the rear of the washer, carefully pull out the power supply cord through the hole in the backsheet.

- Replace the service panel and screws.

NOTE: If the washer is to be transported at a later date, the shipping support hardware must be reinstalled to prevent shipping damage. Retain the hardware in the plastic bag provided.

INSTALLATION

- Run some water from the hot and cold faucets to flush the water lines and remove particles that might clog up the water valve screens.
- Remove the inlet hoses and rubber washers from the plastic bag and install the rubber washers in each end of the inlet hoses.



- (90° elbow end) Carefully connect the inlet hose marked "HOT" to the outside "H" outlet of the water valve. Tighten by hand, then tighten another 2/3 turn with pliers. Carefully connect the other inlet hose to the inside "C" outlet of the water valve. Tighten by hand, then tighten another 2/3 turn with pliers.

Do not crosstread or over-tighten these connections.

- Connect the inlet hose ends to the HOT and COLD water faucets tightly by hand, then tighten another 2/3 turn with pliers. Turn the water on and check for leaks.

NOTE: Use only new hoses.

- Carefully move the washer to its final location.

NOTE: Do not use the dispenser drawer or door to lift washer.

- With the washer in its final position, place a level on top of the washer (if an undercounter installation, no rocking of the washer should exist). Adjust the front leveling legs up or down to ensure the washer is resting solid. Turn the lock nuts on each leg up towards the base of the washer and snug with a wrench.

NOTE: Keep the leg extension at a minimum to prevent excessive vibration. The farther out the legs are extended the more the washer will vibrate.

If the floor is not level or is damaged, the rear leveling legs may have to be extended. For undercounter installations, rear leg adjustment is accessible through the front service panel.

- Form a U shape on the end of the drain hose with the hose pointed toward the drain. Place in a laundry tub or standpipe and secure with the cable tie provided in the enclosure package.

NOTE: If the drain hose is placed in a standpipe without forming a U shape, a siphoning action could occur. There must be an air gap around the drain hose. A snug hose fit can also cause a siphoning action.

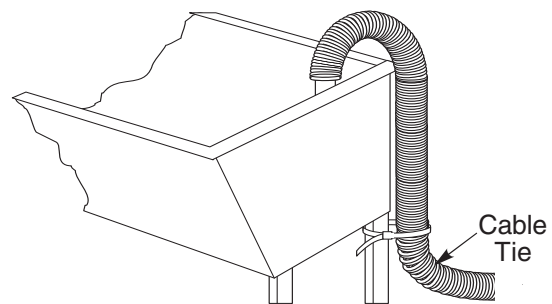
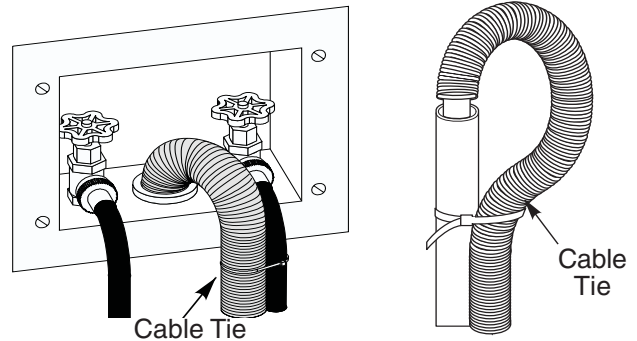

- Plug the power cord into a grounded outlet.

NOTE: Check to ensure the power is off at a circuit breaker/fuse box before plugging the power cord into an outlet.

- Turn on the power at a circuit breaker/fuse box.
- Read the Operating Instructions and Owner's Guide provided with the washer. They contain valuable and helpful information that will save you time and money.

11. Run the washer through a complete cycle. Check for water leaks and proper operation.
12. If your washer does not operate, please review the "Avoid Service Checklist" in your Owner's Guide before calling for service.
13. Place these instructions in a location near the washer for future reference.

NOTE: A wiring diagram is located inside the washer on the service panel.

REPLACEMENT PARTS

If replacements parts are needed for your washer, contact the source where you purchased your washer or call 1-800-944-9044 for the Frigidaire Company Authorized Parts Distributor nearest you.

⚠ WARNING Destroy the carton and plastic bags after the washer is unpacked. Children might use them for play. Cartons covered with rugs, bedspreads, or plastic sheets can become airtight chambers causing suffocation. Place all materials in a garbage container or make materials inaccessible to children.

⚠ WARNING The instructions in this manual and all other literature included with this washer are not meant to cover every possible condition and situation that may occur. Good safe practice and caution **MUST** be applied when installing, operating and maintaining any appliance.

Maximum benefits and enjoyment are achieved when all the Safety and Operating instructions are understood and practiced as a routine with your laundering tasks.

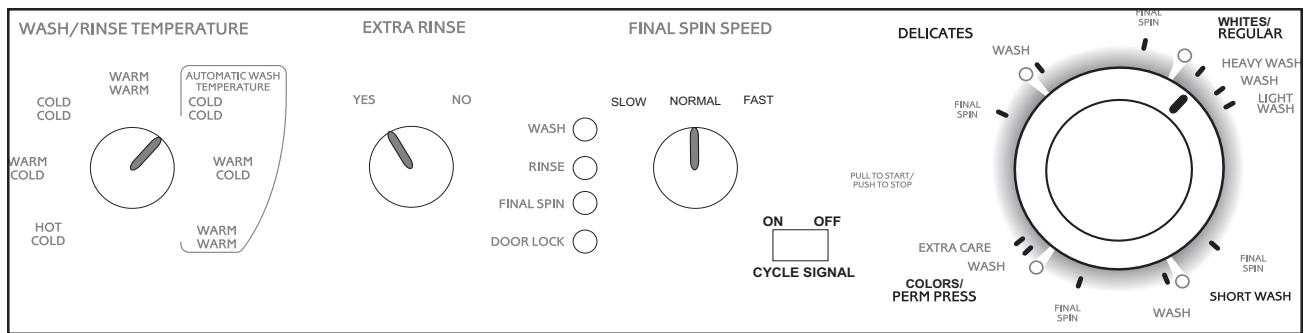

SECTION B - OPERATING INSTRUCTIONS

NOTE: This section provides an example of operating instructions that is printed in the **OWNER'S GUIDE** of certain models of tumble action washers. For detailed operating instructions that pertain to the consumer's specific model, please refer to the consumer's **OWNER'S GUIDE**.

Before Operating Your Washer

Read your washer **Use and Care Guide**. It has important safety and warranty information. It also has many suggestions for best washing results.

⚠ WARNING To reduce the risk of fire, electric shock, or injury to persons, read the **IMPORTANT SAFETY INSTRUCTIONS** in your washer **Use and Care Guide** before operating this appliance.

Operating Steps

Read and follow **Washing Procedures** in your **Use and Care Guide**. It provides detailed information for preparing the wash load and choosing control settings to ensure best washing results.

1. **Sort laundry into loads that can be washed together.**
2. **Prepare items for washing.**
3. **Pretreat stains and heavy soil.**
4. **Add laundry load to the wash drum.**
5. **Open the dispenser drawer and add the measured amount of detergent to the detergent compartment.** If desired, add liquid bleach and fabric softener to the appropriate compartments. Slowly close dispenser drawer. The washer will

not operate with the drawer open.

6. **Set Wash/Rinse Temperature switch according to fabric type and soil level of each load.**
7. **If desired, select Extra Rinse in Whites/Regular, Colors/Perm Press, or Delicates cycle.**
8. **Select Final Spin Speed as desired.**
9. **Push in the cycle selector knob and turn it clockwise to the desired wash cycle and setting.**
10. **Start the washer by closing the door and pulling out the cycle selector knob.** The washer will **not** operate with the door open. As a safety measure, the door will automatically lock during the entire wash cycle. When the door is closed, the **Door Lock Indicator** lights up when the washer starts, and turns off at the end of the cycle.
 - To stop the washer, push in the cycle selector knob.
 - To change a cycle, push in the cycle selector knob and turn it clockwise to the desired setting.
 - Pull out the knob to restart the washer.
11. **Remove items when cycle ends.** A signal will sound at the end of the cycle when the Cycle Signal **ON** is selected.

Note: From time to time you may see water in the bleach and fabric softener compartments. This is a result of the siphoning action and is part of the normal operation of the washer.

Cycle Selection

For best results, follow the fabric care label directions on items to be washed.

Whites/Regular Cycle

Up to 18 minutes of reversing tumble action for most fabrics. Three rinses, two spins, a pause and a brief tumble complete the cycle. Select **SLOW, NORMAL** or **FAST** Final Spin as desired.

- **Heavy Wash** provides up to 18 minutes of reversing tumble action for heavily soiled fabrics.
- **Wash** provides up to 13 minutes of reversing tumble action for normally soiled fabrics.
- **Light Wash** provides up to 6 minutes of reversing tumble action for lightly soiled fabrics.

Short Wash Cycle

Saves time and water. Up to 6 minutes of reversing tumble action for very lightly soiled fabrics. Two rinses, two spins, a pause and a brief tumble complete the cycle. Extra Rinse is not an option with this water conserving cycle. Select **SLOW, NORMAL** or **FAST** Final Spin as desired for this cycle.

Colors/Perm Press Cycle

Up to 13 minutes of reversing tumble action for cottons and blends with a no-iron finish. Three rinses, two spins, a pause and a brief tumble complete the cycle. Select **SLOW, NORMAL** or **FAST** Final Spin as desired for this cycle.

- **Wash** provides up to 13 minutes of reversing tumble action for heavily soiled fabrics.
- **Extra Care** provides up to 6 minutes of reversing tumble action for lightly soiled fabrics.

Knits and Delicates Cycle

Up to 10 minutes of gentle tumble action for the gentle care of knit, delicate and hand washable items. Two rinses and two spins complete the cycle. Select **SLOW, NORMAL** or **FAST** Final Spin as desired for this cycle.

Controls

Always follow instructions on fabric care labels.

Note: There is no need to select a water level because the washer automatically adjusts the water level to the type and size of wash load.

TEMPERATURES - This determines water temperatures for washing and rinsing. For example, the Warm/Cold setting provides a warm water wash and a cold water final rinse.

Note: Detergents are not as effective at wash water temperatures below 65°F (18.3°C).

The following chart suggests wash/rinse temperatures for basic fabric types.

<u>Fabric Type</u>	<u>Wash/Rinse</u>	
	<u>Temperature</u>	
Heavily soiled white/colorfast cotton, perm press	Hot/Cold	
Normally soiled white/colorfast cotton, perm press	Warm/Cold*	
Lightly soiled/noncolorfast fabrics, knits, delicates, hand washables	Cold/Cold*	
Washable woolens	Warm/Cold*	

* unregulated or Automatic Wash Temperature

CYCLE SIGNAL - A signal will sound at the end of the cycle when the Cycle Signal is set to **ON**. This can be turned off by selecting **OFF** on the Cycle Signal switch.

INDICATOR LIGHTS will turn on during the appropriate portions of each cycle: **WASH, RINSE**, and **FINAL SPIN**. When the door is closed, the **Door Lock Indicator** lights up when the cycle selector knob is pulled out, and turns off at the end of the cycle.

Auto Temp Control

The normal temperature of warm and cold wash water can be affected by the hot water heater setting and seasonally low ground water temperatures in some geographic areas. Since detergents work best in wash water at a minimum of 65° F, select an **Auto Temp Control** to regulate the temperature of the warm and cold wash water in any cycle.

Wash water in the **Auto Temp Warm/Cold** and **Auto Temp Warm/Warm** settings is regulated to approximately 100° F. and the wash water in the **Auto Temp Cold/Cold** setting is regulated to approximately 70° F. Rinse water temperatures are not regulated.

EXTRA RINSE - Use Extra Rinse when additional rinsing is desired to remove excess dirt and detergent from heavily soiled loads.

- Select **Extra Rinse YES** to automatically include an extra rinse in Whites/Regular, Colors/Perm Press, or Delicates cycle.
- Select **Extra Rinse NO** to conserve water when an extra rinse is not desired.

FINAL SPIN - There are three final spin speed options available for each cycle. Note: The speeds will vary from cycle to cycle. For example, **Regular Fast** spin speed is much faster than **Delicate Fast** spin speed.

- **SLOW** is recommended for hand washables and items which may wrinkle easily.
- **NORMAL** is recommended for most loads.
- **FAST** provides a faster spin speed to increase water extraction and decrease drying time.

SECTION C - OWNER'S GUIDE

FRIGIDAIRE (SAMPLE WARRANTY ALWAYS CHECK WARRANTY WITH PRODUCT)
 Tumble Action Washer Warranty *Keep your sales receipt!*

WARRANTY LENGTH:	FRIGIDAIRE WILL PAY FOR:
FULL ONE-YEAR WARRANTY From Date of Purchase	Labor and replacement parts which prove to be defective in materials or workmanship. <i>Any warranty service must be provided by Frigidaire or an authorized Frigidaire</i>
LIMITED 2nd-5th YEAR WARRANTY From Date of Purchase	Replacement part for the motor, driven pulley or motor controller which prove to be defective.
LIMITED 2nd-25th YEAR WARRANTY From Date of Purchase	Replacement part for an inner wash basket that breaks due to a defect in materials or workmanship. (Excludes Alaska)

FRIGIDAIRE WILL NOT PAY FOR:

- Service calls where the problem is *not the fault* of the washer. Below are some, but not every example of issues where **you must pay the service call cost.**
Service calls to:
 - remove shipping devices or to level your washer
 - correct leaks at water inlet hose connections
 - correct improper placement of drain hose in your drain
 - advise you on proper setting of controls or to instruct you how to use the washer**Service calls where the problem is due to:**
 - house wiring faults, improper electrical voltage, blown house fuse, tripped circuit breaker
 - slow or backed-up drain, weak (spongy) floor, insects or rodents causing the problem
 - frozen water lines in the washer or house
 - washer installed outside, exposed to the elements
- Repairs for washer used in a commercial application or more than single-family household use.
- Repairs for delivery damage to your washer or damage caused by misuse, fire, flood, acts of God, or use of parts or servicers not authorized by Frigidaire.
- Any labor costs during the limited warranties.
- Travel costs of servicer to your home in the state of Alaska.
- Pickup, delivery or installation of your washer.
- Repairs on products with serial plates that have been altered, removed, or cannot be read.
- Consequential or incidental damages such as property damage and incidental expenses resulting from any breach of this written or any implied warranty. *Some states do not allow the exclusion or limitation of incidental or consequential damages, so this limitation or exclusion may not apply to you.*

Keep your sales receipt. The date on the receipt establishes the warranty period should service be required. This written warranty gives you specific rights. You may also have other rights which vary from state to state. If you need service, first read "Avoid Service Checklist" section of this booklet. If service is still needed, contact Frigidaire Home Products Consumer Service or an authorized Frigidaire servicer. For information on where to obtain service, contact our **Consumer Assistance Center** at 1-800-944-9044.

Product features or specifications as described or illustrated are subject to change without notice. This warranty made by White Consolidated Industries, Inc. applies only in the 50 states of the U.S.A. and Puerto Rico.

Product Registration

Thank you for choosing this washer. This owner's guide will explain proper operation and care.

Record Your Model and Serial Numbers

Record below the model and serial numbers found on the washer serial plate located at the top, inside of the door opening. Keep these numbers and the dated sales receipt for future reference.

Model Number _____

Serial Number _____

Date of Purchase _____

Register Your Product

The self-addressed **PRODUCT REGISTRATION CARD** should be filled in completely, signed and returned.

Instructional Website

www.spinandtumble.com is an instructional website with a slide show presentation. It highlights features unique to this tumble action washer and will help you operate your washer correctly. This website is especially helpful if your previous washer was a top load model.

This Owner's Guide provides general operating instructions for your washer. It also contains information about features for several other models. Your washer may not have every feature included here.

Use the washer only as instructed in this Owner's Guide and the **Operating Instructions** card included with your washer.

FOR YOUR SAFETY

Do not store or use gasoline or other flammable vapors or liquids in the vicinity of this or any other appliance.

©2001 White Consolidated Industries, Inc.
All rights reserved.

Important Safety Instructions

Read all instructions before using this washer.

⚠ WARNING To reduce the risk of fire, electrical shock, or injury to persons when using this washer, comply with the basic warnings listed below.

⚠ Failure to comply with these warnings could result in serious personal injuries.

Prevent Fire

⚠ WARNING Do not wash items that have been previously cleaned in, soaked in, or spotted with gasoline, cleaning solvents, kerosene, cooking oils, waxes, etc. Do not store these items on or near the washer. These substances give off vapors or chemical reactions that could ignite or explode.

⚠ WARNING Do not put oily or greasy rags or clothing on top of the washer. These substances give off vapors that could ignite the materials.

⚠ WARNING Do not add gasoline, cleaning solvents, or other flammable or explosive substances to the wash water. These substances give off vapors that could ignite or explode.

⚠ WARNING Under certain conditions, hydrogen gas may be produced in a hot water system that has not been used for 2 weeks or more. **HYDROGEN GAS IS EXPLOSIVE.** If the hot water system has not been used for such a period, before using the washer, turn on all hot water faucets and let the water flow from each for several minutes. This will release any accumulated hydrogen gas. Hydrogen gas is flammable; do not smoke or use an open flame during this time.

⚠ Failure to comply with these warnings could result in fire, explosion, serious bodily injury and/or damage to the rubber or plastic parts of the washer.

Protect Children

⚠ WARNING Do not allow children to play on or in the washer. Close supervision of children is necessary when the washer is used near children. As children grow, teach them the proper, safe use of all appliances.

⚠ WARNING Destroy the carton, plastic bag and other packing materials after the washer is unpacked. Children might use them for play. Cartons covered with rugs, bedspreads or plastic sheets can become airtight chambers.

⚠ WARNING Keep laundry products out of children's reach. To prevent personal injury, observe all warnings on product labels.

⚠ WARNING Before the washer is removed from service or discarded, remove the washer door to prevent accidental entrapment.

⚠ Failure to comply with these warnings could result in serious personal injuries.

⚠ WARNING Avoid fire hazard or electrical shock. Do not use an adaptor plug or extension cord or remove grounding prong from electrical power cord. Failure to follow this warning can cause serious injury, fire or death.

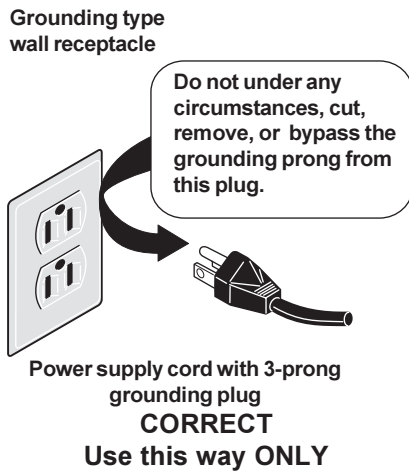

⚠ WARNING Do not use or mix liquid chlorine bleach with other household chemicals such as toilet cleaners, rust removers, acid or products containing ammonia. These mixtures can produce dangerous fumes which can cause serious injury or death.



Note: The instructions appearing in this Owner's Guide are not meant to cover every possible condition and situation that may occur. Common sense and caution must be practiced when installing, operating and maintaining any appliance.

Prevent Injury

⚠ WARNING To prevent shock hazard and assure stability during operation, the washer must be installed

and electrically grounded by a qualified service person in accordance with local codes. Installation instructions are packed in the washer for installer's reference. Refer to INSTALLATION INSTRUCTIONS for detailed grounding procedures. If the washer is moved to a new location, have it checked and reinstalled by a qualified service person.

⚠ WARNING To prevent personal injury or damage to the washer, the electrical power cord of the washer must be plugged into a properly grounded and polarized 3-prong outlet. **The third grounding prong must never be removed. Never ground the washer to a gas pipe. Do not use an extension cord or an adaptor plug.**

⚠ WARNING Follow package directions when using laundry products. Incorrect usage can produce poisonous gas--resulting in serious injury or death.

- **Do not** combine laundry products for use in 1 load unless specified on the label.
- **Do not** mix chlorine bleach with ammonia or acids such as vinegar.

⚠ WARNING To prevent serious personal injury and damage to the washer:

- **All repairs and servicing must be performed by an authorized servicer** unless specifically recommended in this Owner's Guide. Use only authorized factory parts.
- **Do not** tamper with controls.
- **Do not** install or store the washer where it will be exposed to the weather.
- **Do not** install on carpet. Install washer on a solid floor. It may be necessary to reinforce the floor to prevent vibration or movement.

⚠ WARNING To reduce the risk of electric shock, disconnect this appliance from the power supply before attempting any user maintenance. Turning the controls to the OFF position does not disconnect this appliance from the power supply.

⚠ WARNING To prevent injury, do not reach into the washer while parts are moving. Before loading, unloading or adding items, push in the cycle selector knob and allow the drum to coast to a complete stop before reaching inside.

! Failure to comply with these warnings could result in serious personal injuries.

! This washer is equipped with an electrical overload protector. The motor will stop if it becomes overheated. The washer will automatically restart after a cool down period of up to 30 minutes, if the washer has not been manually turned off during this time.

SAVE THESE INSTRUCTIONS

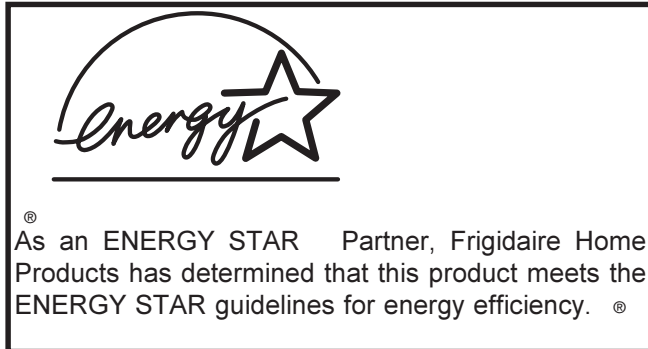

Washing Procedures

- Follow the guidelines below for preparing the wash load.
- Read the **Operating Instructions** card for operating your specific model.
- **Always read and follow fabric care and laundry product labels.**

! WARNING To reduce the risk of fire, electrical shock, or injury to persons, read **Important Safety Instructions**, pages 3-4, before operating this washer.

1. Sort laundry into loads that can be washed together.

Sort items by recommended water temperatures and wash time.

- Separate white, light, and colorfast items from dark and noncolorfast items.
- Separate items which shed lint from items which attract lint. Permanent press, synthetic, knit and corduroy items will pick up lint from towels, rugs and chenille bedspreads.
- Separate heavily soiled items from lightly soiled items.

- Separate lacy, sheer and loosely knit items from sturdy items.
- Do not machine wash items containing fiberglass. Small particles of fiberglass left in the drum may stick to fabrics in other loads and cause skin irritation.

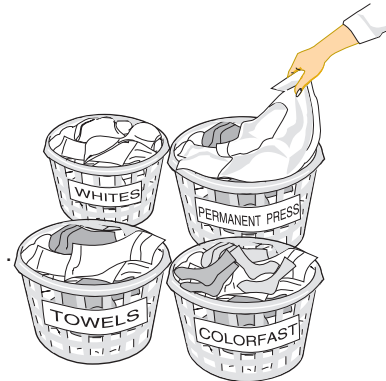

2. Prepare items for washing.

- Empty pockets.

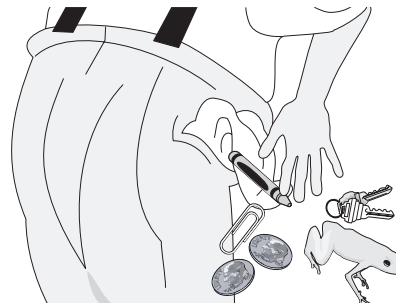

- Brush off lint and dirt. Shake out rugs and beach towels.
- Close zippers, fasten hooks, tie strings and sashes, and remove nonwashable trims and ornaments.
- Remove pins, decorative buttons, belt buckles, and other objects which could be damaged. This also helps protect other items in the wash load.
- Mend rips and tears to prevent further damage during washing.
- Place delicate items such as bras, shoulder pads, hosiery, and belts in a mesh bag to prevent tangling during the wash cycle.

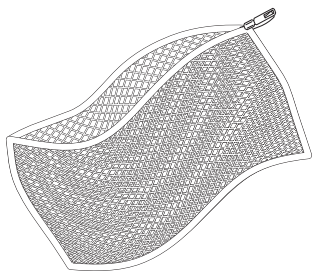

- Turn knit items inside out to prevent pilling.

3. Pretreat stains and heavy soil.

See **Stain Removal**, pages 7-8, for details.

4. Add laundry load to washer.

- Combine large and small items in a load. Load large items first. Large items should not be more than half the total wash load.

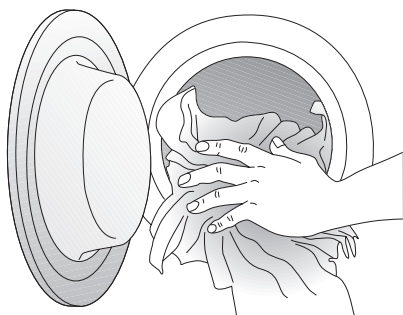

- Washing single items such as a sweater, towel or jeans may cause an out-of-balance load. Add 1 or 2 similar items to help balance the load.
- Single heavy items such as a bedspread can be washed separately.
- The washer can be fully loaded, but the items should not be tightly packed. The door should close easily.

5. Add detergent, bleach and fabric softener to automatic dispenser following these steps:

OPENING AND CLOSING THE DISPENSER DRAWER

- Slowly open the dispenser drawer by first sliding the safety latch to the right, then pulling the drawer out until it stops.
- After adding laundry products, slowly close the

dispenser drawer. Closing the drawer too quickly could result in early dispensing of the bleach and fabric softener.

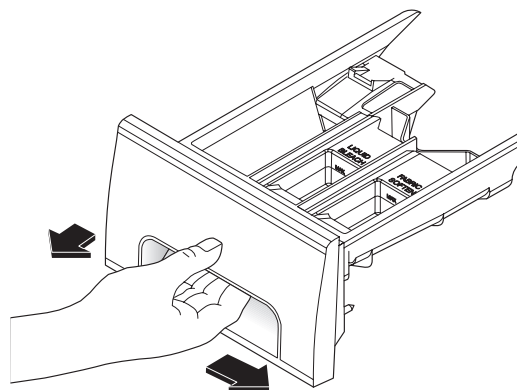

- Laundry products used with powder or liquid detergent, such as color-safe bleach, water conditioner, detergent booster, and enzyme products should be added to the empty tub before loading.

Note: From time to time you may see water in the bleach and fabric softener compartments. This is a result of the siphoning action and is part of the normal operation of the washer.

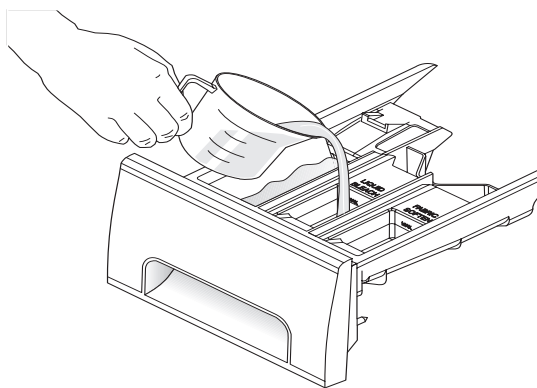

LIQUID BLEACH

- If desired, measure out the recommended amount of liquid chlorine bleach (not to exceed 1/3 cup (80 mL)) and pour it into the center compartment labeled "Liquid Bleach" and marked with this symbol .
- Do not exceed the maximum fill line. Overfilling can cause early dispensing of the bleach which could result in damaged clothes.
- Do not pour undiluted liquid chlorine bleach directly onto the load or into the drum. Fabric damage can occur.

- **Do not use powdered bleach in the dispenser.** **FABRIC SOFTENER**

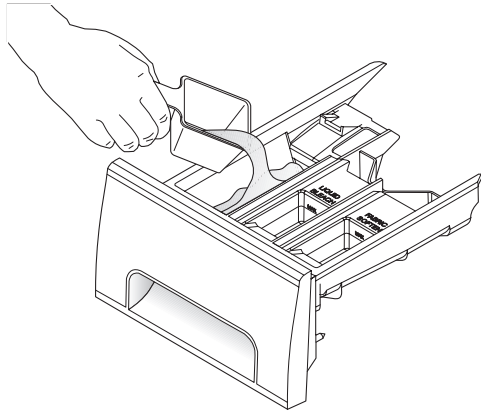

- If desired, pour the recommended amount of fabric softener into the compartment labeled "Fabric Softener" and marked with this symbol.
- Dilute concentrated softeners with warm water to the Fill Line.
- Do not exceed the maximum fill line. Overfilling can cause early dispensing of the fabric softener which could result in stained clothes.
- **Do not pour fabric softener directly on the wash load.**
- Use of a fabric softener dispensing ball is not recommended in tumble action washers.

DETERGENT

- Add measured detergent to the detergent compartment of the dispenser drawer.
- Detergent is flushed from the dispenser at the beginning of the cycle. Either powdered or liquid detergent can be used. **Note:** Liquid detergent will drain into the washer drum as it is added.
- Low sudsing detergent is recommended for this washer. Use the manufacturer's recommended amount.
- If low sudsing detergent is not available, a reduced amount of regular detergent may be used. Because reducing the amount of detergent may reduce cleaning, it is important to pretreat stains, sort carefully by color and soil level, and avoid overloading.
- Detergent usage may need to be adjusted for water temperature, water hardness, size and soil level of the load.
- For best results, avoid oversudsing.

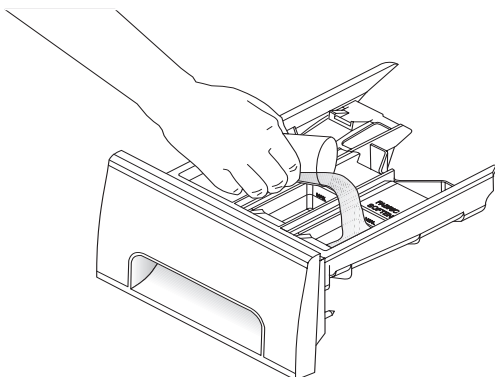

6. Set cycle selector knob and washer controls according to type, size, and soil level of each load.

(See **Operating Instructions** card for your specific model controls.)

7. Start the washer.

Close the washer door and pull out the cycle selector knob. For your safety, the door will automatically lock during the entire wash cycle. The Door Lock indicator light will remain lit until the cycle ends.

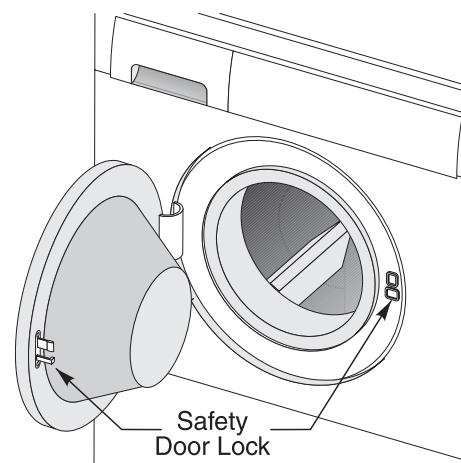

- Washer will fill and tumble.
- To stop the washer, push in the cycle selector knob.

- To open the door during tumbling, push in the cycle selector knob. Wait for the water to run off of the door.
- To change a cycle, push in the cycle selector knob and turn it **clockwise** to the desired setting. Pull out the knob to restart the washer.
- To open the door during a spin cycle, push in the cycle selector knob. The Door Lock indicator light will turn off. Wait 1-2 minutes for the lock to release. The door can then be opened. Do not force open the locked door.

8. Remove items when the cycle is completed.

Place washed items in automatic dryer, line dry, or dry flat as directed by fabric care label. Excess wrinkling, color transfer or odors may develop in items left in the washer after the cycle has ended.

9. General Precautions

- **If the dispenser drawer is pulled out more than 1-1/2" when the washer is in operation, the washer will shut off.** The Door Lock indicator light will turn off and the door will be unlocked. Slowly close the drawer, and the washer will automatically resume operation.
- **Do not slam the washer door closed or try to force the door open when locked (Door Lock light ON).** This could result in damage to the washer.
- **DO NOT leave the washer door open.** An open door could entice children to hang on the door or crawl inside the washer.



- To avoid damaging the washer and personal injury, **DO NOT** hang on or lean against the washer door.
- Do not place detergent, bleach or fabric softener containers on top of the washer. They can damage the finish or controls.

Stain Removal

⚠ WARNING Do not use or mix liquid chlorine bleach with other household chemicals such as toilet cleaners, rust removers, acid or products containing ammonia. These mixtures can produce dangerous fumes which can cause serious injury or death.

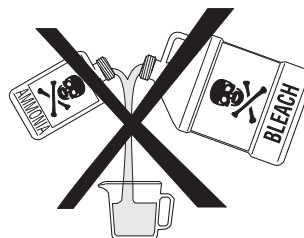

Safe Stain Removal Procedures

⚠ WARNING To reduce the risk of fire or serious injury to persons or property, comply with the basic warnings listed below:

- Read and comply with all instructions on stain removal products.
- Keep stain removal products in their original labeled containers and out of children's reach.
- Thoroughly wash any utensil used.
- Do not combine stain removal products, especially ammonia and chlorine bleach. Dangerous fumes may result.
- Never wash items which have been previously cleaned in, washed in, soaked in or spotted with gasoline, dry cleaning solvents or other flammable or explosive substances because they give off vapors that could ignite or explode.
- Never use highly flammable solvents, such as gasoline, inside the home. Vapors can explode on contact with flames or sparks.

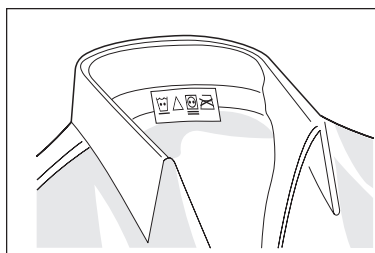

Follow fabric care label instructions.

For successful stain removal:

- Remove stains promptly.
- Determine the kind of stain, then follow the recommended treatment in the stain removal chart below.
- To pretreat stains, use a prewash product, liquid detergent, or a paste made from granular detergent and water.
- Use cold water on unknown stains because hot water can set stains.
- Check care label instructions for treatments to avoid on specific fabrics.
- Check for colorfastness by testing stain remover on an inside seam.
- Rinse and wash items after stain removal.

STAIN REMOVAL	
Stain	Treatment
Adhesive tape, chewing gum, rubber cement	Apply ice. Scrape off excess. Place stain face down on paper towels. Saturate with prewash stain remover or nonflammable dry cleaning fluid.
Baby formula, dairy products, egg	Use product containing enzymes to pretreat or soak stains. Soak for 30 minutes or more. Wash.
Beverages (coffee, tea, soda, juice, alcoholic beverages)	Pretreat stain. Wash using cold water and bleach safe for fabric.
Blood	Rinse with cold water. Rub with bar soap. Or, pretreat or soak with product containing enzymes. Wash using bleach safe for fabric.
Candle wax, crayon	Scrape off surface wax. Place stain face down between paper towels. Press with warm iron until wax is absorbed. Replace paper towels frequently. Treat remaining stain with prewash stain remover or nonflammable dry cleaning fluid. Hand wash to remove solvent. Wash using bleach safe for fabric.
Chocolate	Pretreat or soak in warm water using product containing enzymes. Wash using bleach safe for fabric.
Collar or cuff soil, cosmetics	Pretreat with prewash stain remover or rub with bar soap.
Dye transfer on white fabric	Use packaged color remover. Wash using bleach safe for fabric.
Grass	Pretreat or soak in warm water using product containing enzymes. Wash using bleach safe for fabric.
Grease, oil, tar (butter, fats, salad dressing, cooking oils, car grease, motor oils)	Scrape residue from fabric. Pretreat. Wash using hottest water safe for fabric. For heavy stains and tar, apply nonflammable dry cleaning fluid to back of stain. Replace towels under stain frequently. Rinse thoroughly. Wash using hottest water safe for fabric.
Ink	Some inks may be impossible to remove. Washing may set some inks. Use prewash stain remover, denatured alcohol or nonflammable dry cleaning fluid.
Mildew, scorch	Wash with chlorine bleach if safe for fabric. Or, soak in oxygen bleach and hot water before washing. Badly mildewed fabrics may be permanently damaged.
Mud	Brush off dry mud. Pretreat or soak with product containing enzymes.
Mustard, tomato	Pretreat with prewash stain remover. Wash using bleach safe for fabric.
Nail polish	May be impossible to remove. Place stain face down on paper towels. Apply nail polish remover to back of stain. Repeat, replacing paper towels frequently. Do not use on acetate fabrics.
Paint, varnish	WATER BASED: Rinse fabric in cool water while stain is wet. Wash. Once paint is dry, it cannot be removed. OIL BASED AND VARNISH: Use solvent recommended on can label. Rinse thoroughly before washing.
Perspiration	Use prewash stain remover or rub with bar soap. Rinse. Wash using nonchlorine bleach in hottest water safe for fabric.
Rust, brown or yellow discoloration	For spots, use rust remover safe for fabric. For discoloration of an entire load, use phosphate detergent and nonchlorine bleach. Do not use chlorine bleach because it may intensify discoloration.
Shoe polish	LIQUID: Pretreat with a paste of granular detergent and water. PASTE: Scrape residue from fabric. Pretreat with prewash stain remover or nonflammable dry cleaning fluid. Rinse. Rub detergent into dampened area. Wash using bleach safe for fabric.
Urine, vomit, mucus, feces	Pretreat or soak in product containing enzymes. Wash using bleach safe for fabric.

COMMON WASHING PROBLEMS

Many washing problems involve poor soil and stain removal, residues of lint and scum, and fabric damage. For satisfactory washing results, follow these suggestions provided by The Soap and Detergent Association.

PROBLEM	POSSIBLE CAUSES	SOLUTIONS	PREVENTIVE MEASURES
Blue stains	<ul style="list-style-type: none"> • Undiluted liquid detergent or fabric softener dispensed directly onto fabric. 	<ul style="list-style-type: none"> • If caused by detergent, mix 1 cup (240 ml) white vinegar with 1 quart (.95 L) water in plastic container. Soak item 1 hour. Rinse. • If caused by fabric softener, rub stains with bar soap. Wash. 	<ul style="list-style-type: none"> • Avoid overfilling detergent and fabric softener compartments of dispenser.
Discoloration, graying	<ul style="list-style-type: none"> • Not enough detergent. • Wash temperature too low. • Incorrect sorting. 	<ul style="list-style-type: none"> • Rewash with correct amount of detergent and hottest water safe for fabric. Add bleach safe for fabric. 	<ul style="list-style-type: none"> • Sort items by soil level and color. • Use correct amount of detergent, hottest water and bleach safe for fabric.
Greasy, oily stains	<ul style="list-style-type: none"> • Not enough detergent. • Undiluted liquid fabric softener poured directly on fabric. 	<ul style="list-style-type: none"> • Treat with prewash stain remover or liquid detergent. • Increase detergent and water temperature. Rewash. • Rub fabric softener stains with bar soap. 	<ul style="list-style-type: none"> • Use correct amount of detergent and hottest water safe for fabric. • Do not pour liquid fabric softener directly on fabric. See Washing Procedures on adding softener.
Holes, tears, or snags	<ul style="list-style-type: none"> • Incorrect use of chlorine bleach. • Unfastened zippers, hooks, buckles. • Rips, tears and broken threads. • Overloading the washer. • Degradation of fabric. 	<ul style="list-style-type: none"> • May be irreversible if rips, tears and seams cannot be mended. 	<ul style="list-style-type: none"> • Never pour chlorine bleach directly on fabric. • Check condition of items before washing. See Washing Procedures for preparing, loading and adding chlorine bleach.
Lint	<ul style="list-style-type: none"> • Incorrect sorting. • Tissues left in pocket. • Overloading the washer. • Not enough detergent. • Undissolved detergent has left a residue resembling lint. • Static cling is attracting lint. • Load washed too long. 	<ul style="list-style-type: none"> • Reduce load size. Rewash using correct water temperature, water level, and amount of detergent. • Add nonprecipitating water conditioner to wash water to remove detergent residue. • Add liquid fabric softener to final rinse. • Dry load in dryer. • Remove lint with lint brush or roller. 	<ul style="list-style-type: none"> • See Washing Procedures for sorting and preparing the wash load. • Do not overload washer. • Use correct temperature and amount of detergent, water and wash time.
Pilling (Fibers break off, ball up and cling to fabric.)	<ul style="list-style-type: none"> • Pilling is normal with synthetic and permanent press fabrics. This is due to abrasion from normal wear. 	<ul style="list-style-type: none"> • Use a lint brush or shaver to remove pills. 	<ul style="list-style-type: none"> • Use fabric softener in the washer to lubricate fibers. • When ironing, use spray starch or fabric finish on collars/cuffs. • Turn items inside out to reduce abrasion.
Residue or powder on dark items; stiff, harsh fabrics.	<ul style="list-style-type: none"> • Undissolved detergent. • Some nonphosphate granular detergents can combine with hard water minerals to form a residue. • Overloading the washer. 	<ul style="list-style-type: none"> • Rewash load. 	<ul style="list-style-type: none"> • Increase water temperature using hottest water safe for fabric. • Do not overload washer. • Use liquid detergent or use nonprecipitating water conditioner with nonphosphate granular detergent.
Wrinkling	<ul style="list-style-type: none"> • Overloading the washer. • Incorrect wash cycle for wash load. 	<ul style="list-style-type: none"> • Reduce load size. • Rinse in cold water with liquid fabric softener using the Perm Press or Delicate cycle. 	<ul style="list-style-type: none"> • Do not overload washer. • Remove items from washer as soon as cycle is completed. • Use liquid fabric softener.
Yellow buildup of body soil on synthetic fabrics	<ul style="list-style-type: none"> • Agitation time too short. • Wash water temperature too low. • Not enough detergent. 	<ul style="list-style-type: none"> • Soak in detergent booster or product containing enzymes. • Wash in hot water (120°F/49°C) using full permanent press cycle. Increase detergent. Add bleach or treat with color remover. 	<ul style="list-style-type: none"> • Select correct wash cycle. • Use correct amount of detergent. • Wash synthetics frequently using hot or warm water.
Yellow or brown rust stains	<ul style="list-style-type: none"> • Iron or manganese in water supply, water pipes, or water heater. 	<ul style="list-style-type: none"> • To restore discolored load of whites, use rust remover safe for fabric. • Do not use chlorine bleach to remove rust stains. It may intensify stains. 	<ul style="list-style-type: none"> • Use nonprecipitating water softener. • Before washing, run hot water for a few minutes to clear lines.

CARE AND CLEANING

Outside

- When washing is completed, wipe top and sides of washer with a damp cloth. Turn water faucets off to prevent pressure build-up in the hoses.
- As needed, clean the cabinet with mild soap and water. **Never use harsh, gritty or abrasive cleansers.** If door or console becomes stained, clean with diluted chlorine bleach [1/2 cup (120 ml) in 1 quart (.95 L) water]. Rinse several times with clear water.
- Remove glue residue from tape or labels with a mixture of warm water and mild detergent. Or, touch residue with the sticky side of the tape or label.
- **Before moving the washer,** place a strip of cardboard or thin fiberboard under the front leveling legs to prevent floor damage.

Cleaning the Dispenser Drawer Area

Detergent and fabric softener may build up in the dispenser drawer. Residue should be removed once or twice a month.

- Remove the drawer by first sliding the safety latch to the right, then pulling the drawer out until it stops.

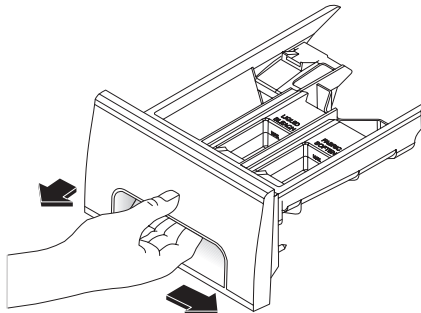

- Reach back into the left rear corner of the drawer cavity and press down firmly on the lock tab (left rear portion of the drawer). Pull out the drawer.

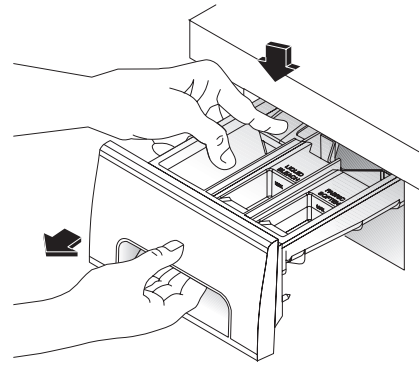

- Remove the inserts from the bleach and fabric softener compartments.

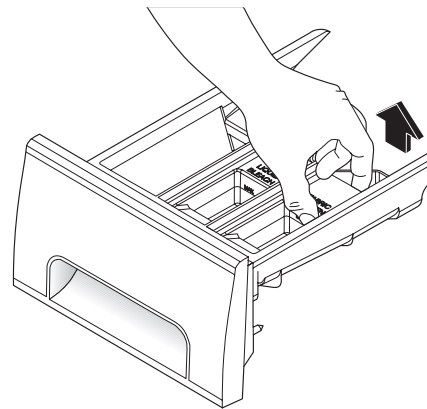

- Rinse the drawer and inserts with hot tap water to remove traces of accumulated powders and liquids. Large amounts of fabric softener residue may indicate improper dilution or more frequent cleaning is required.
- To clean the drawer opening, use a small brush to clean the recess. Remove all residue from the upper and lower parts of the recess.

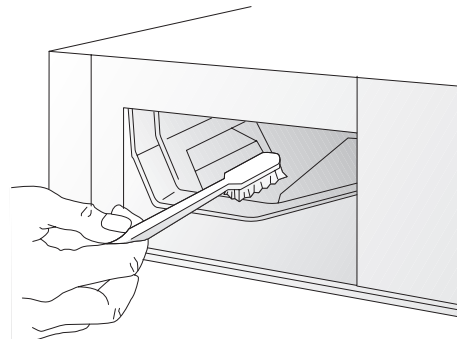

- Return the bleach and fabric softener inserts to their proper compartments. Replace the dispenser drawer and run the Prewash cycle without any wash load in the drum.

Inside

- Remove items from the washer as soon as the cycle ends. Excess wrinkling, color transfer, and odors may develop in items left in the washer.
- Before cleaning the washer interior, **unplug the electrical power cord** to avoid electrical shock hazards.
- Dry around the washer door opening, flexible gasket, and door glass. These areas should always be clean to ensure a water tight seal.
- When extremely soiled items have been washed, a dirty residue may remain on the drum. Remove this by wiping the drum with a nonabrasive household cleanser. Rinse thoroughly with water.
- The plastic drum vanes may become stained from fabric dye. Clean these parts with a nonabrasive household cleanser. This prevents dye transfer to future loads.

Winterizing Instructions

If the washer is stored in an area where freezing can occur or moved in freezing temperatures, follow these winterizing instructions to prevent damage to the washer:

1. Turn off water supply faucets.
2. Disconnect hoses from water supply and drain water from hoses.
3. Plug electrical cord into a properly grounded electrical outlet.
4. Add 1 gallon (3.8 L) nontoxic recreational vehicle (RV) antifreeze to empty wash drum. Close door.
5. Set cycle selector knob at a spin setting. Pull out knob and let washer spin for 1 minute to drain out all water. Not all of the RV antifreeze will be expelled.
6. Push in knob, unplug electrical power cord, dry drum interior, and close door.
7. Remove dispenser drawer. Drain any water in compartments and dry compartments. Replace drawer.
8. Store washer in an upright position.
9. To remove antifreeze from washer after storage, run empty washer through a complete cycle using detergent. **Do not add wash load.**

Avoid Service Checklist

Before calling for service, review this list. It may save both time and expense. The list includes common concerns that are not the result of defective workmanship or materials in this washer.

OCCURRENCE

POSSIBLE CAUSE / SOLUTION

"Clicking" noise.	• A normal sound made by the timer.
High pitch "jet engine" noise.	• A certain amount of motor whine is normal during the spin cycle.
Rattling and clanking noise.	<ul style="list-style-type: none"> • Foreign objects such as coins or safety pins may be in drum or pump. Stop washer and check drum. If noise continues after washer is restarted, objects may be in pump. Call your authorized servicer. • Belt buckles and metal fasteners are hitting wash drum. To prevent unnecessary noise and damage to drum, fasten fasteners and turn items inside out.
Squealing sound or hot rubber odor.	• Washer is overloaded. Do not overload washer. Stop washer and reduce load.
Thumping sound.	• Heavy wash loads may produce a thumping sound. This is usually normal. If sound continues, washer is probably out of balance. Stop washer and redistribute wash load.

OCCURRENCE

POSSIBLE CAUSE / SOLUTION

Vibrating noise.

- Washer is not resting firmly on floor. Move washer so it rests firmly on floor. Adjust leveling legs. See **INSTALLATION INSTRUCTIONS** for details.
- Shipping bolts and foam block have not been removed during installation. See **INSTALLATION INSTRUCTIONS** for removing shipping bolts and foam block.
- Wash load unevenly distributed in drum. Stop washer and rearrange wash load.

Washer does not start.

- Electrical power cord may not be plugged in or connection may be loose. Make sure plug fits tightly in wall outlet.
- House fuse blown, circuit breaker tripped, or a power outage has occurred. Reset circuit breaker or replace fuse. Do not increase fuse capacity. If problem is a circuit overload, have it corrected by a qualified electrician. If problem is a power outage, call local electric company.
- Water supply faucets are not turned on. Turn on water supply faucets.
- Cycle selector is not in correct position. Move indicator clockwise slightly. Pull out knob.
- Motor is overheated. Washer motor will stop if it becomes overheated. It will automatically restart after a cool down period of up to 30 minutes (if washer has not been manually turned off).
- Dispenser drawer is not completely closed. Close dispenser drawer.

Washer won't spin.

- Washer door is not completely closed. Close door completely.
- Dispenser drawer is not completely closed. Close dispenser drawer.
- Load is too small. Add 1 or 2 similar items to help balance the load.

Residue left in tub.

- Heavily soiled items. Wipe drum with a nonabrasive household cleanser, then rinse. Shake or brush excess dirt and sand from items before washing.

Water collects in bleach and fabric softener compartments.

- This is a result of the siphoning action and is part of the normal operation of the washer. Water may be removed by removing the dispenser drawer into the empty drum or sink.

Wash load too wet after spin.

- Washer is overloaded. Do not overload washer. See **Washing Procedures**.
- Load is too small. Add 1 or 2 similar items to help balance the load.
- Load is out of balance. Rearrange load to allow proper spinning.
- Drain hose is kinked. Straighten drain hose.

Water does not enter washer or it enters slowly.

- Water supply is not adequate in area. Check another faucet in the house. Wait until water supply and pressure increase.
 - Water supply faucets are not completely open. Fully open hot and cold faucets.
 - Water is being used elsewhere in the house. Water pressure must be at least 30 psi (260 kPa). Avoid running water elsewhere while washer is filling.
 - Water inlet hoses are kinked. Straighten hoses.
-

OCCURRENCE

POSSIBLE CAUSE / SOLUTION

Warm or hot water is not hot enough.

- Hot water heater is set too low or is a distance from washer. Measure hot water temperature at nearby faucet with candy or meat thermometer. Water temperature should be at least 130°F (70°C). Adjust water heater as necessary.
- Hot water is being used elsewhere in the house. Avoid using hot water elsewhere before or during washer use. There may not be enough hot water available for proper cleaning. If problem persists, your hot water system may be unable to support more than 1 use at a time.

Water in washer does not drain or drains slowly.

- Drain hose is kinked or clogged. Clean and straighten the drain hose.

Water leaks.

- Fill hose connection is loose at faucet or washer. Check and tighten hose connections. Install rubber sealing washers provided.
- House drain pipes are clogged. Unclog drain pipes. Contact plumber if necessary.
- Oversudsing. Use less detergent.

Incorrect wash and rinse temperatures.

- Hot and cold water hoses are connected to wrong supply faucets. Connect hot water hose to hot water faucet and cold water hose to cold water faucet.

Water is entering washer, but tub does not fill.

- Drain hose standpipe is incorrect height. Standpipe must be a minimum of 23.6" (60 cm) high to prevent siphoning. See INSTALLATIONINSTRUCTIONS.
-

Service Information (Canada)

To avoid unnecessary cost and inconvenience, make a few simple checks before calling for service. Common occurrences and their solutions can be found in the Avoid Service Checklist. Be sure you have followed the instructions in this manual.

If you are unable to locate the cause of a problem, call for service. Insist on factory service by an authorized FRIGIDAIRE HOME PRODUCTS PARTS AND SERVICE depot.

FRIGIDAIRE HOME PRODUCTS PARTS AND SERVICE

All Frigidaire appliances are backed by FRIGIDAIRE HOME PRODUCTS PARTS AND SERVICE, one of Canada's largest parts and service networks.

The Frigidaire reputation means you can enjoy complete professional service from one of our hundreds of trained technicians across the country. Ask your Frigidaire dealer for details about the Extended Service Plan offered by FRIGIDAIRE HOME PRODUCTS PARTS AND SERVICE to all purchasers of Frigidaire appliances in Canada.

FRIGIDAIRE HOME PRODUCTS PARTS AND SERVICE

7075 Ordan Drive
Mississauga, Ontario
L5T 1K6

Place the name, address and telephone number of your service depot in the spaces below.

Product and feature specifications as described or illustrated are subject to change without notice.

SAMPLE WARRANTY ALWAYS REFER TO WARRANTY WITH PRODUCT



**WARRANTY (CANADA)
FRIGIDAIRE TUMBLE ACTION WASHERS**

WARRANTOR:

Frigidaire Home Products Canada
7075 Ordan Drive
Mississauga, Ontario
L5T 1K6

For service under this warranty, contact your local dealer/retailer, authorized FRIGIDAIRE HOME PRODUCTS PARTS AND SERVICE depot, or:

FRIGIDAIRE HOME PRODUCTS PARTS & SERVICE

7075 Ordan Drive
Mississauga, Ontario
L5T 1K6
Tel.: (905) 565-9200
Fax: (905) 565-0937

WARRANTY PERIOD:

For the first year after purchase by the original consumer/owner:

For the second through fifth year after purchase by the original consumer/owner:

For the second through twenty-fifth year after purchase by the original consumer/owner:

WARRANTOR WILL THROUGH ITS AUTHORIZED SERVICE DEPOT:

Pay all costs to repair or replace any defective parts.

Pay all costs (excluding labour to install) to replace any defective motor, driven pulley, or motor controller.

Pay all costs (excluding labour to install) of an inner wash basket.

WARRANTY APPLIES TO:

- a) Products purchased and installed in Canada for personal single family household use.
- b) Defects resulting or arising out of the manufacturing process.
- c) Products bearing legible manufacturer's model and serial numbers.
- d) Replacement parts only for the remainder of the original warranty.

WARRANTY DOES NOT APPLY TO:

- a) Transportation damage.
- b) Supply and replacement of porcelain, fuses, glass and light bulbs.
- c) Parts and service supplied or obtained from other than FRIGIDAIRE HOME PRODUCTS PARTS AND SERVICE or FRIGIDAIRE HOME PRODUCTS PARTS AND SERVICE authorized depots.
- d) Damage or failure as the result of abuse, improper or commercial use.

CONSUMER/OWNER RESPONSIBILITY:

- a) To provide proof of the original date of purchase by means of a bill of sale or payment record verifying purchase date.
- b) To pay all costs to make the appliance readily accessible for service.
- c) To ensure proper power supply and connection of the appliance to same.
- d) Proper installation, control setting and care of finish.

This warranty is in addition to any statutory warranties contained in any applicable legislation. The terms and conditions of this warranty are not intended to exclude or limit your rights under those statutes. The warrantor however reserves the right to charge transportation and travelling costs for distances in excess of 48 kilometres (30 miles) from the nearest FRIGIDAIRE HOME PRODUCTS PARTS AND SERVICE authorized service depot.

This warranty plus the statutory warranties mentioned are the only warranties given to the consumer/owner for this product.

SECTION D - OPERATION

Timer

The timer is located behind the control panel and controls electrical power to the components of the washer.

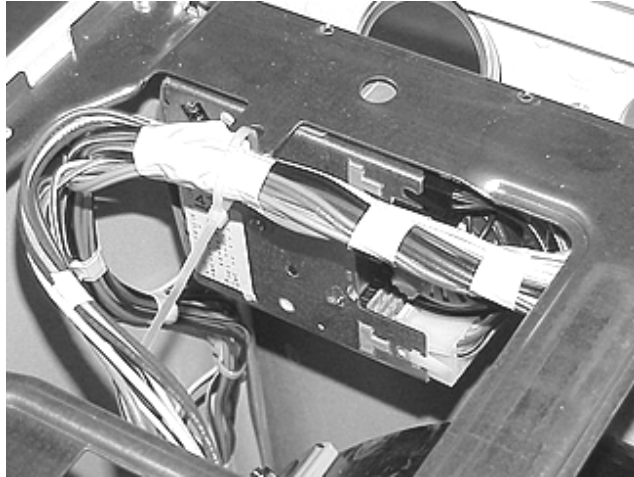

The timer is made up of a motor driven spool that advances one increment a minute whenever electrical power is applied to the motor.

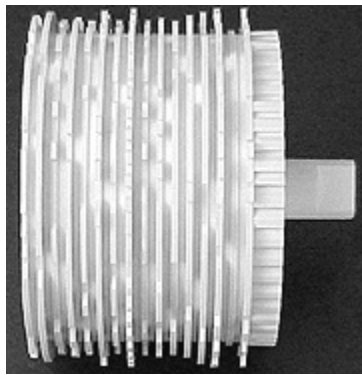

The spool has 14 cams that open and close the 24 contacts and supply electric power to components at the correct time in the cycle.

To help determine when each set of contacts are closed, a timer cycle chart is provided with each washer. (A sample timer cycle chart is shown on the following page.) The first column of the chart is titled CAM. In this column are numbers 0 to 14 that equate to the number of cams starting at the rear of the timer. The next two columns are titled TERM for terminals and are identified as ACTIVE and FIXED. The active terminals are the terminals that are moved by the cams, the fixed terminals are the ones that do not move. The active terminals are usually the terminals that have power applied to them with the

fixed terminals connected to the components that power is being applied to. The next column is titled CONTACT and identified as T for the top contacts of the fixed terminals and B for the bottom contacts of the fixed terminals. The next column is titled CIRCUIT and indicates the circuit controlled by the cam, terminals and contacts. For example, CAM 14, ACTIVE terminal 19, FIXED terminal 24, and CONTACT B controls the drain pump circuit at specific times. Each circuit has a horizontal line extending across the timer chart. The remaining columns make up the wash cycles and are connected by vertical lines below to the step time in minutes and the step number. When the boxes formed by the horizontal lines from the circuit and the vertical lines step time are filled in, this indicates that electrical power is applied to that circuit at that time in the cycle.

IMPORTANT NOTE: Only the cam number and contact are called out on the schematic and wiring diagram.

Line Switch

The line switch is located inside the timer and controls electrical power to the washer. When the timer knob is pulled out the switch contacts are closed. When the timer knob is pushed in or the timer is advanced to the end of the cycle, the contacts are opened.

Dispenser Drawer Reed Switch

The dispenser drawer reed switch is a safety switch that prevents the washer from operating when the dispenser drawer is open. The switch is located behind the control panel next to the dispenser drawer and controls electrical power to the door lock coil and the door lamp.

Its contacts are controlled by the magnetic field of the magnet located in the front panel of the dispenser drawer.

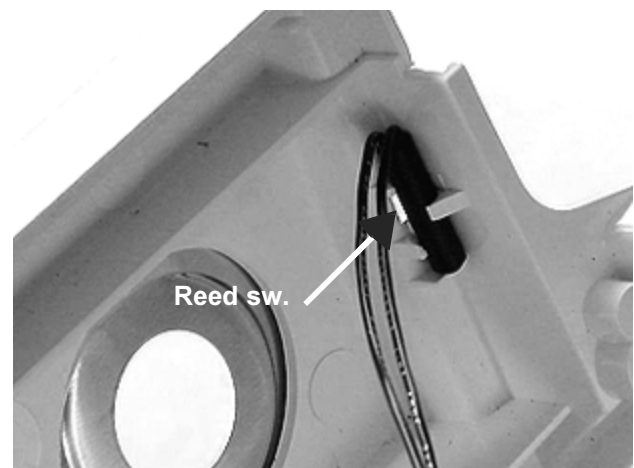

C A M	TERM.		C O N T A C T	CIRCUIT	REGULAR																
	A C T I V E	F I X E D			H E A V Y	W A S H M E D	L I G H T	RINSE AND SPIN						FINAL SPIN							
0/0			T	DETENT																	
0	2	1	T	MACHINE POWER	[Solid black bar]																
1	23	22	T																		
		24	B	CODE A	[Bar]	[Bar]	[Bar]	[Bar]	[Bar]	[Bar]	[Bar]	[Bar]	[Bar]	[Bar]	[Bar]	[Bar]	[Bar]	[Bar]	[Bar]	[Bar]	[Bar]
2	5	4	T																		
		6	B	SOLENOID 2		[Bar]	[Bar]	[Bar]	[Bar]	[Bar]	[Bar]	[Bar]	[Bar]	[Bar]	[Bar]	[Bar]	[Bar]	[Bar]	[Bar]	[Bar]	[Bar]
3	23	19	T																		
		21	B	CODE B	[Bar]	[Bar]	[Bar]	[Bar]	[Bar]	[Bar]	[Bar]	[Bar]	[Bar]	[Bar]	[Bar]	[Bar]	[Bar]	[Bar]	[Bar]	[Bar]	[Bar]
4	5	7	T	CODE E		[Bar]	[Bar]	[Bar]	[Bar]	[Bar]	[Bar]	[Bar]	[Bar]	[Bar]	[Bar]	[Bar]	[Bar]	[Bar]	[Bar]	[Bar]	[Bar]
		9	B	SOLENOID 1																	
5	23	16	T																		
		18	B	CODE C	[Bar]	[Bar]	[Bar]	[Bar]	[Bar]	[Bar]	[Bar]	[Bar]	[Bar]	[Bar]	[Bar]	[Bar]	[Bar]	[Bar]	[Bar]	[Bar]	[Bar]
6	11	10	T	TM DIRECT	[Bar]	[Bar]	[Bar]	[Bar]	[Bar]	[Bar]	[Bar]	[Bar]	[Bar]	[Bar]	[Bar]	[Bar]	[Bar]	[Bar]	[Bar]	[Bar]	[Bar]
			B																		
7	23	13	T																		
		15	B	CODE D	[Bar]	[Bar]	[Bar]	[Bar]	[Bar]	[Bar]	[Bar]	[Bar]	[Bar]	[Bar]	[Bar]	[Bar]	[Bar]	[Bar]	[Bar]	[Bar]	[Bar]
8	14	17	T	WASH WATER MAIN	[Bar]	[Bar]	[Bar]	[Bar]	[Bar]	[Bar]	[Bar]	[Bar]	[Bar]	[Bar]	[Bar]	[Bar]	[Bar]	[Bar]	[Bar]	[Bar]	[Bar]
		15	B	RINSE WATER MAIN		[Bar]	[Bar]	[Bar]	[Bar]	[Bar]	[Bar]	[Bar]	[Bar]	[Bar]	[Bar]	[Bar]	[Bar]	[Bar]	[Bar]	[Bar]	[Bar]
9	23	10	T																		
		12	B	WASH LAMP	[Bar]	[Bar]	[Bar]	[Bar]	[Bar]	[Bar]	[Bar]	[Bar]	[Bar]	[Bar]	[Bar]	[Bar]	[Bar]	[Bar]	[Bar]	[Bar]	[Bar]
10	17	16	T	RINSE WATER TEMP																	
		18	B	WASH WATER TEMP	[Bar]	[Bar]	[Bar]	[Bar]	[Bar]	[Bar]	[Bar]	[Bar]	[Bar]	[Bar]	[Bar]	[Bar]	[Bar]	[Bar]	[Bar]	[Bar]	[Bar]
11	23	7	T	RINSE LAMP																	
		9	B	FINAL SPIN LAMP																	
12	20	19	T	PRESS SW. BYPASS	[Bar]	[Bar]	[Bar]	[Bar]	[Bar]	[Bar]	[Bar]	[Bar]	[Bar]	[Bar]	[Bar]	[Bar]	[Bar]	[Bar]	[Bar]	[Bar]	[Bar]
		21	B	BUZZER																	
14	19	22	T	DRAIN PUMP - EX RINSE																	
		24	B	DRAIN PUMP		[Bar]	[Bar]	[Bar]	[Bar]	[Bar]	[Bar]	[Bar]	[Bar]	[Bar]	[Bar]	[Bar]	[Bar]	[Bar]	[Bar]	[Bar]	[Bar]
STEP TIME (MIN)					3	2	6	6	1	2	3	2	3	1	2	3	2	8	2		
					.0	.0	.7	.0	.0	.0	.0	.5	.0	.0	.0	.0	.1	.6			
STEP NO.					1				5					10							15

Sample timer cycle chart (partial)

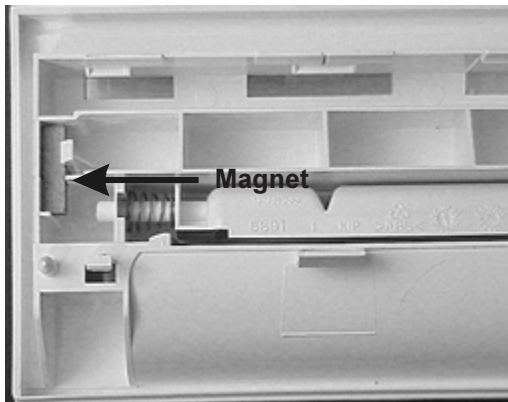

When the drawer is closed the magnet causes the contacts of the reed switch to close providing electrical power to the door lock coil and door lamp. When the

drawer is open, the contacts of the reed switch are open preventing the door switch from closing.

Door Switch Assembly

The door switch assembly, located behind the front panel, is a safety feature that prevents the washer from operating when the door is open and locks the door in the spin cycle. The door lock assembly is made up of a coil, door switch, switch actuator, locking fork, wax motor, and spin lock arm. When the timer line switch is closed electrical power is applied to the coil and the door lock switch. The magnet field of the coil pulls the locking fork down and tries to pull the contacts of the door lock switch closed. If the washer door is open a tab on the switch actuator prevents the contacts from closing, and the

locking fork will not allow the door to be closed until the timer line switch is opened. When the washer door is closed the door strike pivots the switch actuator out of the way allowing the magnetic field of the coil to close the contacts of the door lock switch and the locking fork locks the door. The wax motor and spin lock arm are used to prevent the door from being opened while the spin basket is still spinning. The wax motor is electrically in parallel with the drain pump. Power is applied to the wax motor when the washer is in spin. When power is applied to the wax motor it expands its piston within 30 to 40 seconds driving the spin lock arm between the locking fork and the switch actuator holding the locking fork down. When power is removed from the wax motor it takes about 90 seconds for the wax motor to cool down and retract the piston, pulling the spin lock arm back away from the locking fork. This provides enough time for the spin basket to slow its rotation down to the wash speed before the door could possibly be opened.

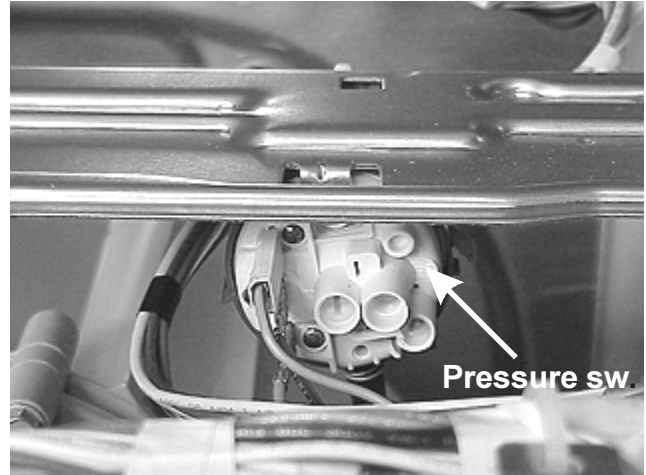

As the tub begin to fill, air trapped in the air bell and hose is compressed increasing the air pressure against the bellow. When the water level reaches about 4 1/2 inches from the bottom of the spin basket the bellow opens contacts 1 to 2 removing power from the water inlet valves, and closes contacts 1 to 3 providing power to other components.

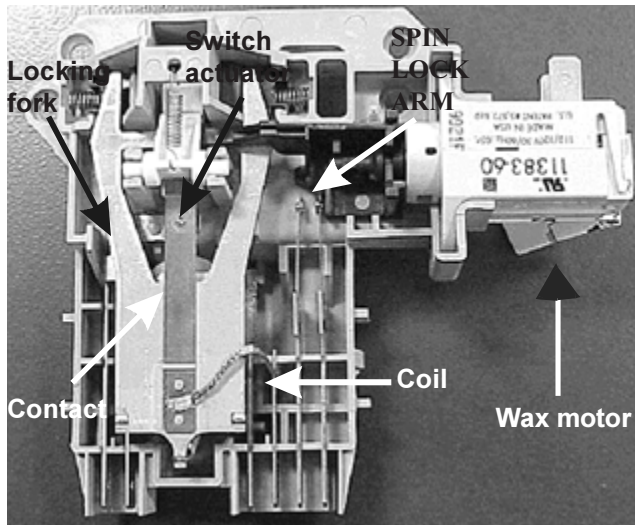

Pressure Switch

The pressure switch is mounted to the center bar under the top of the washer and controls the water level in the washer. The pressure switch is made up of a single pole double throw switch that is controlled by a bellow which cover a sealed chamber. The chamber is connect by a hose to the air bell located at the bottom of the washer attached to the drain boot. Electrical power is applied to the pressure switch whenever the contacts of the door switch are closed. If the water level is below 2.8 inches from the bottom of the spin basket, contacts 1 to 2 of the pressure switch close applying power to the active terminal of cam 8 of the timer. When the timer advances to the fill increment, water enters the tub.

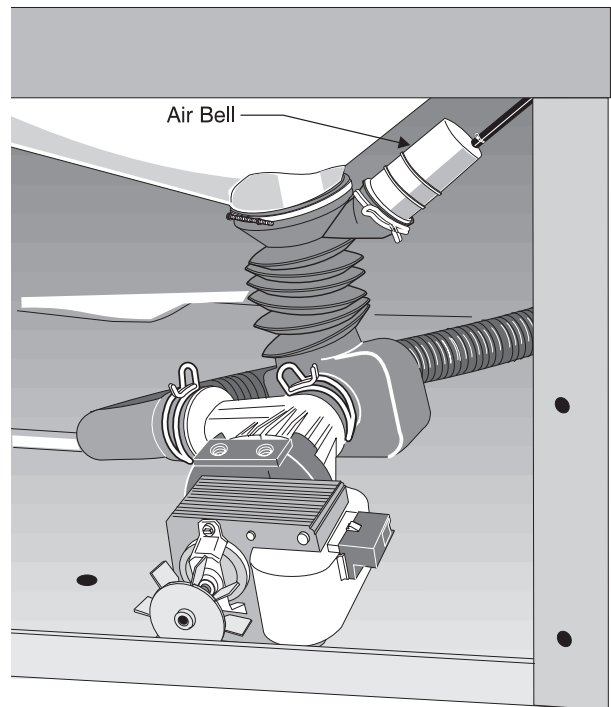

Automatic Dispenser

The automatic dispenser for detergent, liquid bleach and fabric softener system is made up of the dispenser cavity,



and a removable drawer with three cavities, one for detergent, one for bleach and one for fabric softener.

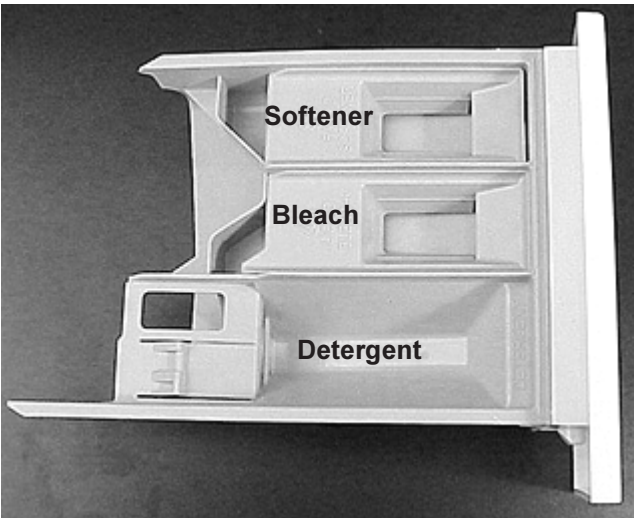
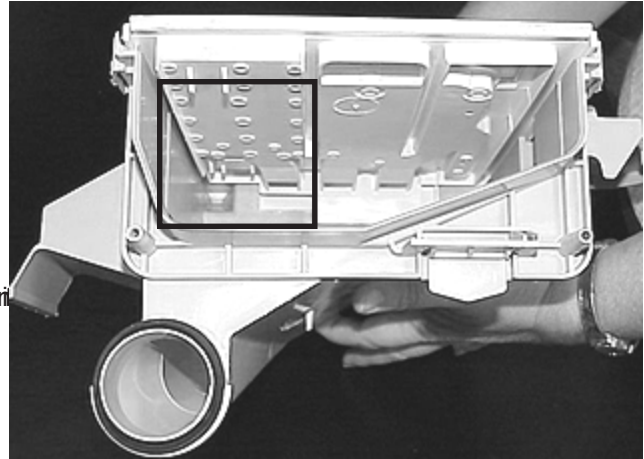

The dispenser cavity is connected to the water inlet valve by a hose.

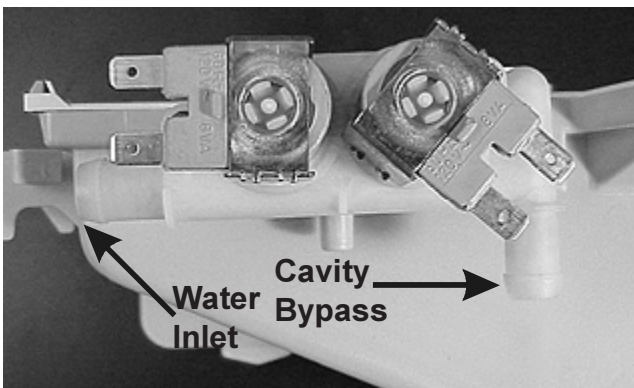

Bleach and fabric softener dispensing is controlled by the timer at specified times in the cycle by using the electrical solenoids and redirecting some of the water fill into their containers. The bleach and the fabric softener cavities have tubes molded into the bottom which allows the cavity to be filled without being immediately dispensed into the washer.

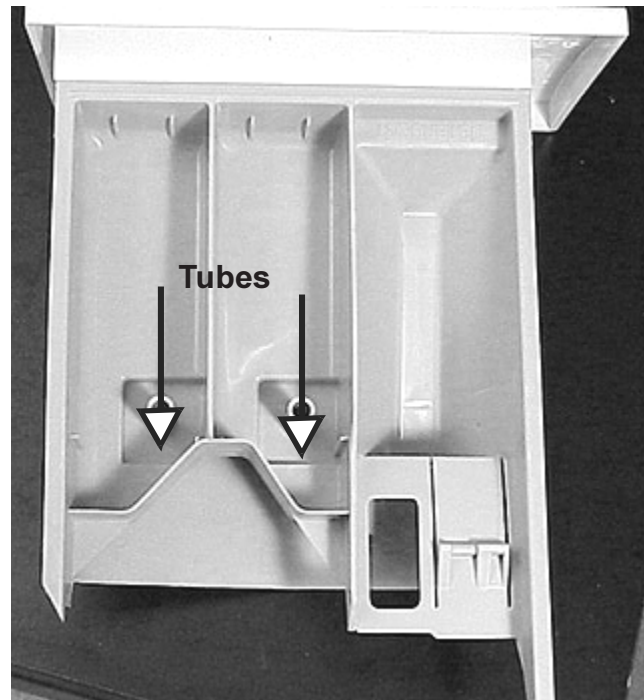

Bleach and fabric softener inserts fit into each respective cavity and have a tube molded onto them. These tubes are larger than the tubes in the cavity and are designed to fit over the tubes, but not touch the bottom of the cavity when the insert is installed. When the correct time comes for the bleach or the fabric softener to enter the washer the timer supplies 120 VAC to the solenoid behind that cavity allowing part of the incoming water to flow into the cavity from above.

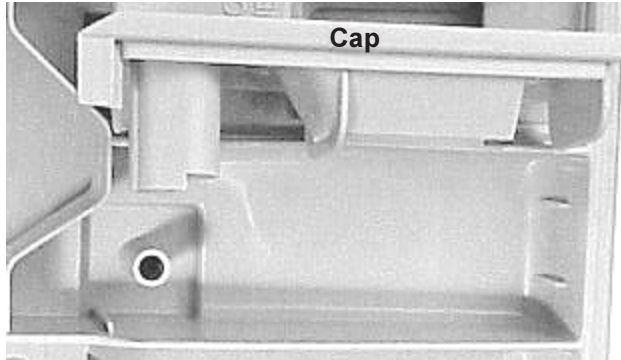

When water is added to either the bleach or fabric softener liquid, the mixture level rises between the two tubes above the tube in the cavity and flows into the washer tub. Since the end of the tube on the insert does not touch the bottom of the cavity, a siphoning action will start when the solenoid activates and allows water into the cavity. The added water creates an “overflow” condition and starts the siphoning. The cavity will empty itself when the water is turned off by the solenoid.

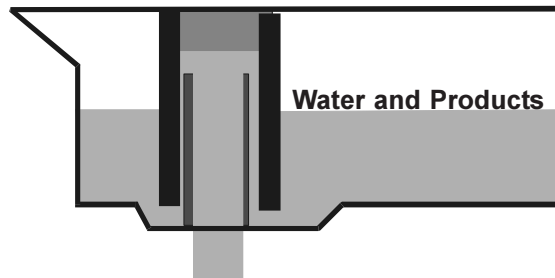

Temperature Switch

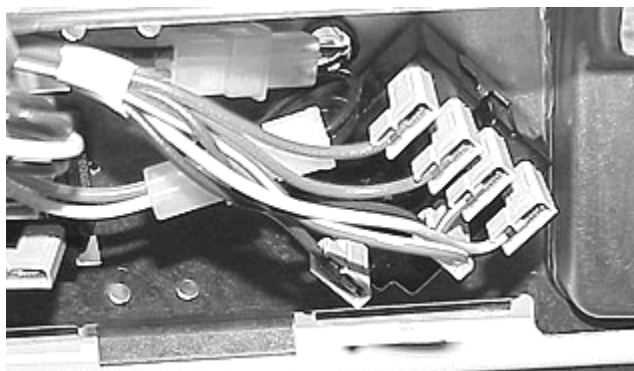

The temperature switch, mounted behind the control panel, controls the water temperature in the wash and rinse cycles by supplying power to the water valve, and in some models, the auto temperature control.

The switch has 3 input terminals that receive power from the timer. Two output terminals (on models without the auto temp feature) are connected to the hot and cold solenoids of the water valve. If the model has the auto temp feature the switch has a third output terminal supplying power to the auto temp control.

Auto Temp System

The auto temp system is made up of the auto temp control, mounted under the top lip of the right side panel and a positive thermal sensor connected in the water hose between the water valve and the dispenser.

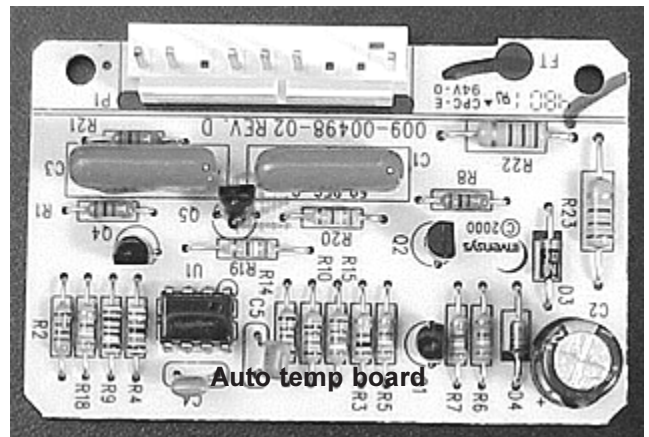
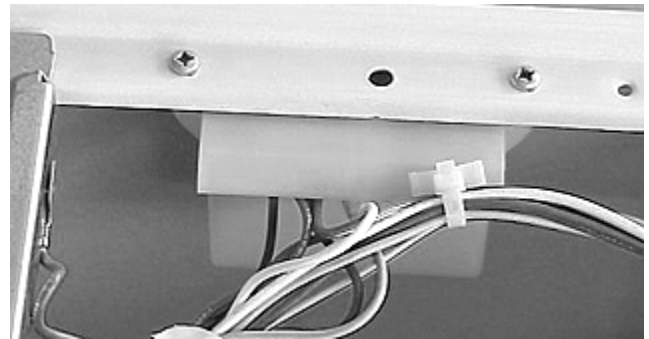

When the temperature selector switch is set to regulated warm/warm or regulated warm/cold, electrical power is supply to the hot water solenoid by contacts 1 and 3 of the temperature selector switch. The auto temperature control cycles the cold water solenoid using the information received from the sensor to control the wash water temperature to 98 +/- 7 degrees F.

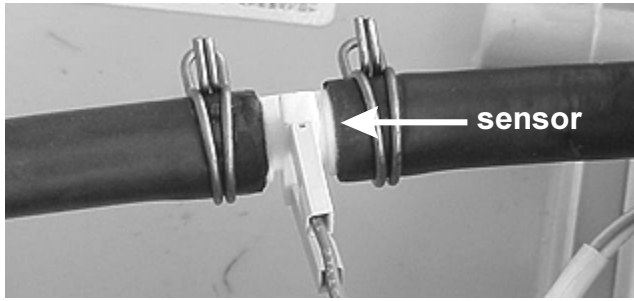

When the temp selector switch is set to regulated cold/cold electrical power is supplied to the cold water solenoid by contacts 1 and 5 of the temperature selector switch. The auto temperature control cycles the hot water solenoid using the information received from the sensor to control the wash water temperature to 66 +/- 7 degrees F.

Water Inlet Valve

The water valve is mounted to the rear rail under the main top in the lefthand corner.

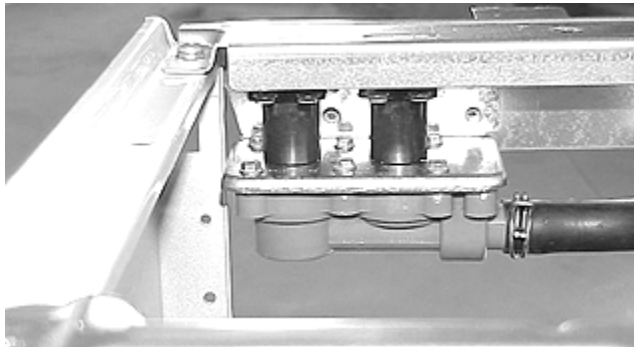

The water inlet valve is actually two solenoid operating valves in one body. A hot water valve and a cold water valve discharge into a common mixing chamber. The flow of water out of the chamber is controlled by a molded in flow washer capable of maintaining a flow rate of 3.0 - 14.6 gallons per minute, with incoming water pressure of 30 to 120 P.S.I. The inlet valve is controlled by the timer and water temperature selector switch, individually or together, to provide hot, cold, or warm water for washing and cold or warm water for rinsing. The temperature of the warm mixture will be dependent upon the temperature and pressure of the hot and cold water supply lines or the auto temp control.

Valve Operation

Both inlet solenoid valves are identical in construction and operation. The valve body provides an air passage

with a large orifice and seat where the water can be stopped. The outlet of the valve body empties into the mixing chamber. A moveable rubber diaphragm operates against the valve seat to start and stop the flow of water. The diaphragm is operated by water pressure. It has a small bleed orifice outside the seat contact area, and a large main orifice at its center. The armature of the solenoid serves to open and close the main orifice. The armature operates within a closed metal tube (valve guide) which is sealed by the outer edge of the diaphragm to the valve body. A coil spring holds the armature down against the diaphragm main orifice when the solenoid is not energized.

The following line drawings and text explains basic valve operation.

When the valve is in a closed position, the solenoid is not energized. Water has bled through the diaphragm bleed orifice placing incoming line pressure on top of the diaphragm. The bottom of the diaphragm is essentially at atmospheric pressure (open to the outlet) and the pressure differential holds the valve shut.

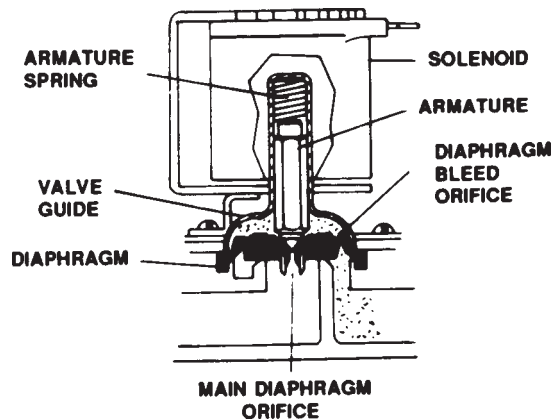

Water Valve Closed

When the solenoid is energized, the resulting magnetic field pulls the armature up into the valve guide. The armature spring is compressed by this action. When the armature moves up, it allows the water on the top of the diaphragm to drain through the main orifice.

The diaphragm bleed orifice is much smaller than the main orifice and will not admit enough water to maintain pressure on the top side of the diaphragm. Thus, as the pressure on the top of the diaphragm is reduced to almost zero, the pressure on the bottom lifts the diaphragm off the valve seat, allowing a full flow of water.

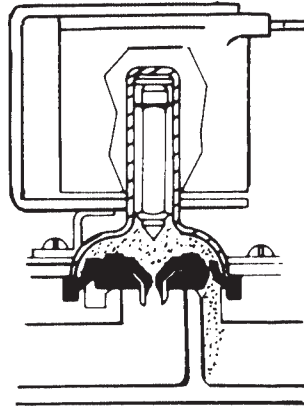

Solenoid Activated

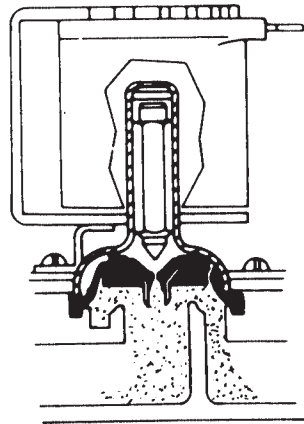

Water Valve Open and Diaphragm Up

When the solenoid is de-energized, the armature drops down, closing the diaphragm main orifice. Water continues to flow through the diaphragm bleed orifice, equalizing the pressure and allowing the spring to push the diaphragm down against the valve seat.

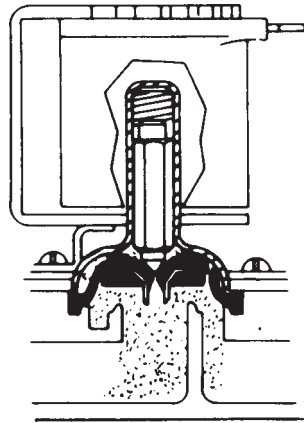

Water Valve Closing

Extra Rinse Switch

The extra rinse switch is mounted behind the control panel.

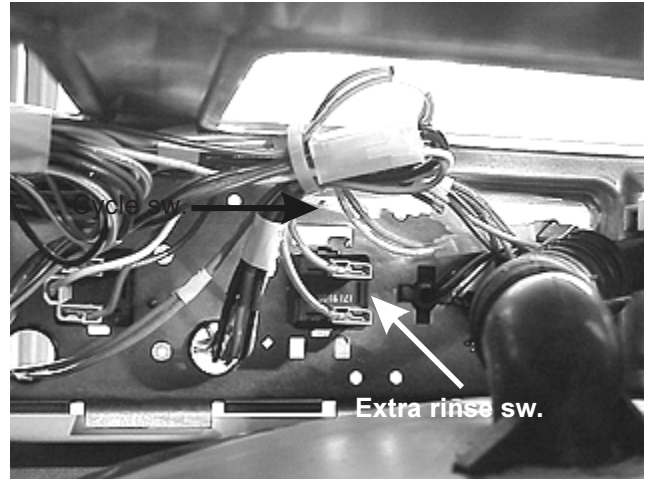

The extra rinse switch provides an extra rinse in the regular wash cycle when selected. This is accomplished by energizing the drain pump to remove the water from the wash tub. When enough water is removed from the tub that the pressure switch is no longer satisfied, the pressure switch will reset and energize the fill valve, thus creating an extra rinse.

Drain Pump

The drain pump is mounted to the bottom plate of the washer, in the right front corner, behind the access panel. It operates on 120 VAC and is controlled by the timer. The pump out specifications of the drain pump vary from 12 G.P.M with a 3 foot standpipe height to 7 G.P.M. with a 8 foot standpipe height.



End of Cycle Signal Switch.

The end of cycle switch is mounted to the control panel.

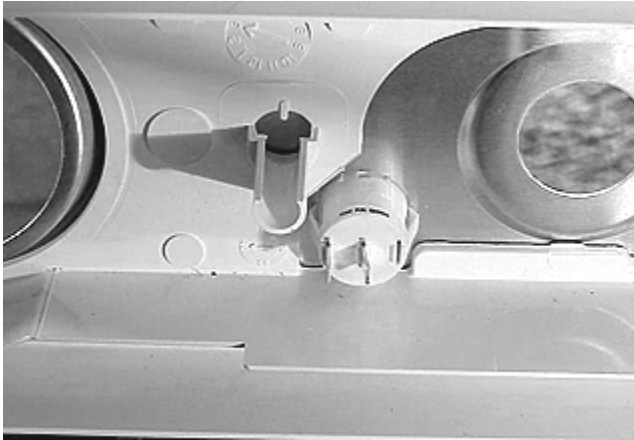

The end of cycle switch controls power to the cycle signal (buzzer). When the switch is turned on the cycle signal will buzz at the end of each cycle.

End Of Cycle Signal

The end of cycle signal (buzzer) is mounted to the control mounting bracket behind the control panel.

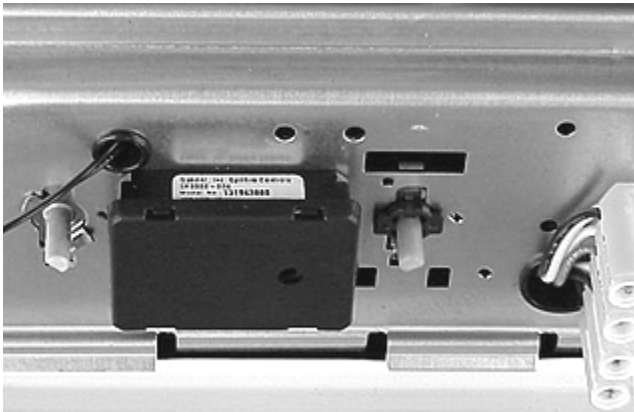

Speed Control

The speed control is mounted to the bottom plate of the washer in the right rear corner of the washer. The board controls the following operations:

1. Advancement of the timer by connecting and disconnecting neutral to the timer motor. Timer contacts 6C to 6T are electrically in parallel with the switch in the speed control board and are used as a backup or to sequence the timer when the knob is turned.

2. The timing of each function, and the speed and direction of the drive motor. In previous front load washers the timer used slip disc inside the timer to extend the increments, such as the 13 minute fill and agitate increment. Contacts of the timer were also used to reverse the polarity on the motor armature of the drive motor to reverse the drive motor. These functions have been removed from the timer and added to the new speed control board. The speed control board has six terminals marked on the schematic as A,B,C, D,E, and F that receive inputs or codes from the contacts of the timer. Each terminal receives an input of either line to neutral voltage (120 VAC) or zero for each function. For example if the code received by the speed control board is 120 VAC on terminals A, B, and D and zero on terminals C, E, and F this tells the board to allow the washer to fill, tumble at 52 RPMs for 107 seconds, then close the contact that connects the neutral side of the timer motor so it advances to give the next code.
3. The speed of the drive motor by converting input line to neutral single phase 60 Hertz voltage, to a varying frequency, three phase output voltage from zero to 300 VAC. By varying the amount, frequency, and polarity of the voltage and comparing the input from the tachogenerator on the drive motor, the speed control board can operate the drive motor at a preprogrammed speed and direction.
4. The balance of the load in the washer during the spin cycle by converting the sine wave from the tachogenerator to square waves and comparing the distance between the square waves.

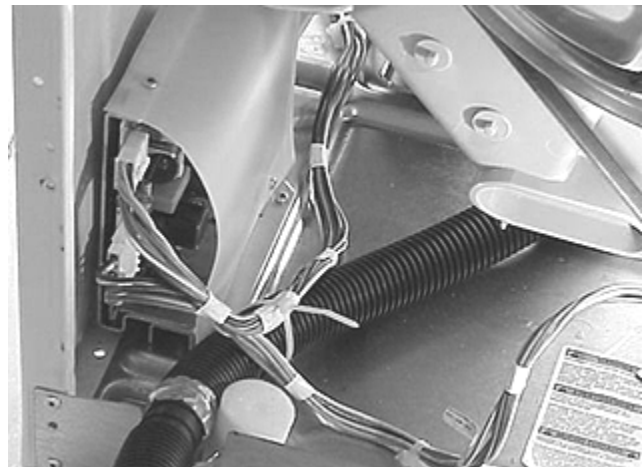

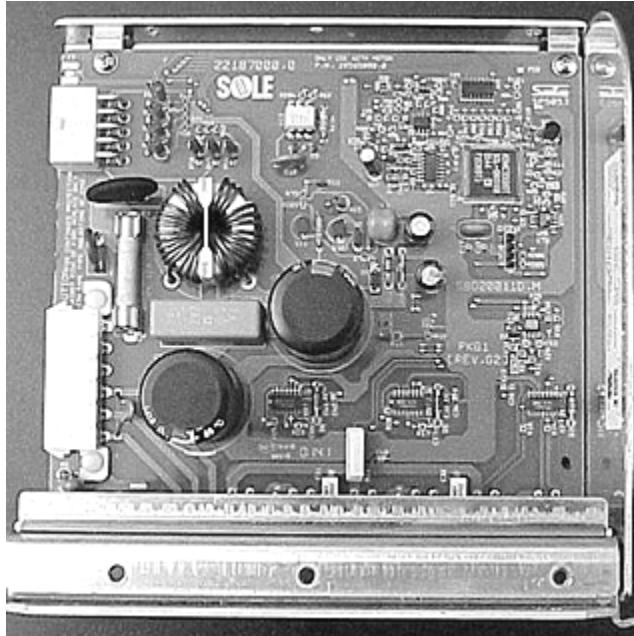

Speed Control Board

Speed Switch (some models)

The speed switch, mounted to the control mounting bracket behind the control panel, controls the speed of the final spin.

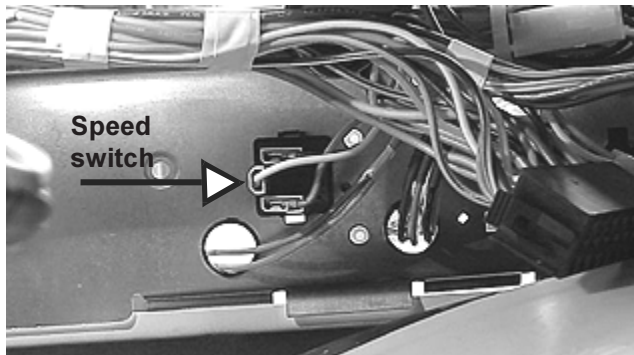

Depending on the model the speed switch will either be a two terminal single pole, single throw switch or a three terminal single pole, double throw switch.

Speed Switch Two terminals		Speed Switch Three terminals	
Circuit	1 - 2	5 - 6	4 - 5
Slow	NA	X	
Normal	X		X
Fast			

Motor

The motor is mounted to the bottom of the outer tub.



The motor is an induction, three phase AC motor that varies speeds when the voltage from the speed control board varies in frequency and amount. The motor has a tachogenerator that inputs the speed of the motor to the speed control board.

SECTION E - CONSTRUCTION

The front loading, tumble action clothes washer consists of a perforated, cylindrical spin basket suspended horizontally on its axis within a larger solid cylindrical tub. This assembly is suspended by springs within a four piece steel cabinet. A see through door and a flexible bellows (seal) provides access for loading and unloading clothes.

Front console models are shipped with a painted top panel, but a galvanized panel is available if the washer is to be installed undercounter.

Cabinet

The cabinet is made of heavy steel in a four piece design with an enamel finish. The sides and front are riveted at the front corners and base. The rear of the cabinet is galvanized steel and is secured with screws.

Front Panel and Door Assembly

The front panel is riveted to the side panels for maximum strength and structural rigidity.

Bellows

The bellows is a rubber sleeve that seals the suspended outer tub to the stationary cabinet front at the tub opening. Its purpose is to provide a water tight opening into the tub

that can be sealed by the cabinet door, yet allow flexibility for the oscillation of the tub during the wash and spin cycles.

Outer Tub Assembly

The outer tub assembly is supported by two suspension springs and stabilized by two air shock assemblies. Cement counter weights are mounted to the outer tub front (top & bottom), and the rear top. These counter weights prevent excessive oscillation of the entire suspended assembly during an unbalanced spin cycle.

Spin Basket Assembly

The spin basket is constructed of stainless steel. The circumference of the basket is perforated to allow water to flow through it as it revolves. A heavy steel shaft is pressed into the spin basket support which is then bolted to the basket. The spin basket assembly is entirely supported by two ball bearings pressed into the rear of the outer tub.

A large drive pulley is mounted to the free end of the shaft that extends through the rear of the outer tub.

There are three plastic vanes mounted to the spin basket to aid in the washing action during the wash cycle. The rotation of the spin basket provides both the washing action during the wash cycle, and water extraction during the spin cycle.

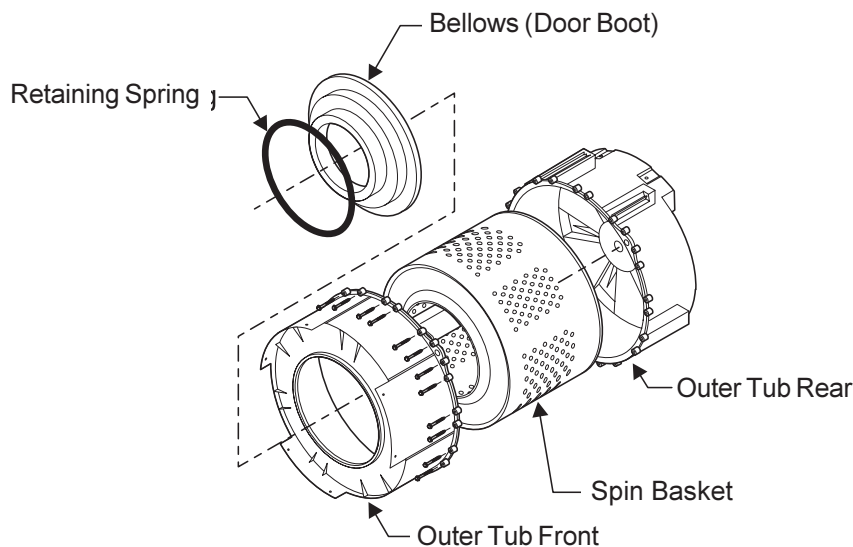

SECTION F - TROUBLESHOOTING FLOW CHARTS

NOTE: Always check the wiring and pin/plug connectors before replacing any component.

Washer completely inoperative.	Page 47
Timer does not advance .	Page 47
Washer does not drain.	Page 48
Extra rinse setting does not work.	Page 48
Bleach dispenser does not operate.	Page 49
Softner dispenser does not operate.	Page 49
Drive motor does not turn.	Page 50
Drive motor spins but does not tumble.	Page 51
Drive motor tumbles but does not spin.	Page 51
Drive motor tumbles very slowly in any timer position.	Page 52
Models with normal & fast speed sw. spinning at incorrect speed for switch setting.	Page 52
Models with slow, normal & fast speed sw. spinning at incorrect speed for switch setting.	Page 53
Water fill does not turn off.	Page 54
Incorrect water level.	Page 54
Slow water fill.	Page 55
Washer will not fill in any setting of the temperature selector sw.	Page 56
Washer will not fill in wash cycle, but will fill in rinse with the temp switch set to cold/cold.	Page 57
Washer will only fill with cold water in the wash cycle, with the temp switch set to warm/cold.	Page 57
Water temperature is too hot or too cold in the wash cycle with the temp sw. set to warm/warm.	Page 58
Washer will only fill with hot water in the wash cycle, with the temp switch set to warm/cold but does fill with cold water in the rinse cycle.	Page 58
Auto temp control does not control the wash water temperature within specification.	Page 59
Indicator lamp (door, wash, rinse or final spin) does not glow.	Page 59
Door indicator lamp does not glow.	Page 60

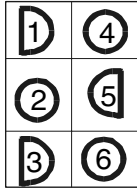

**MOTOR PLUG - MALE
(END VIEW)**

**10 PIN PLUG (C 10)
SPEED CONTROL BOARD**

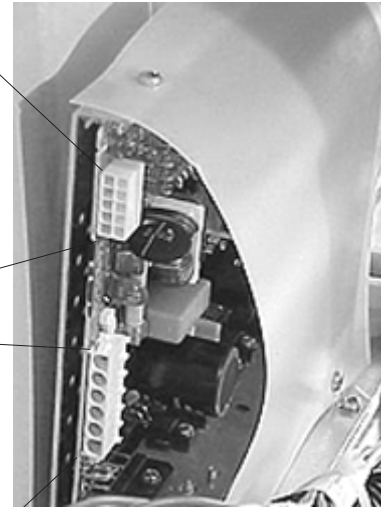
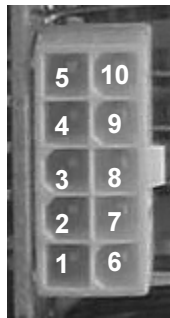

**6 PIN PLUG (C 6)
SPEED CONTROL BOARD**

**10 PIN PLUG (C 10)
SPEED CONTROL BOARD**

**FUSE
(See NOTE
Page 50)**

**6 PIN PLUG (C 6)
SPEED CONTROL BOARD**

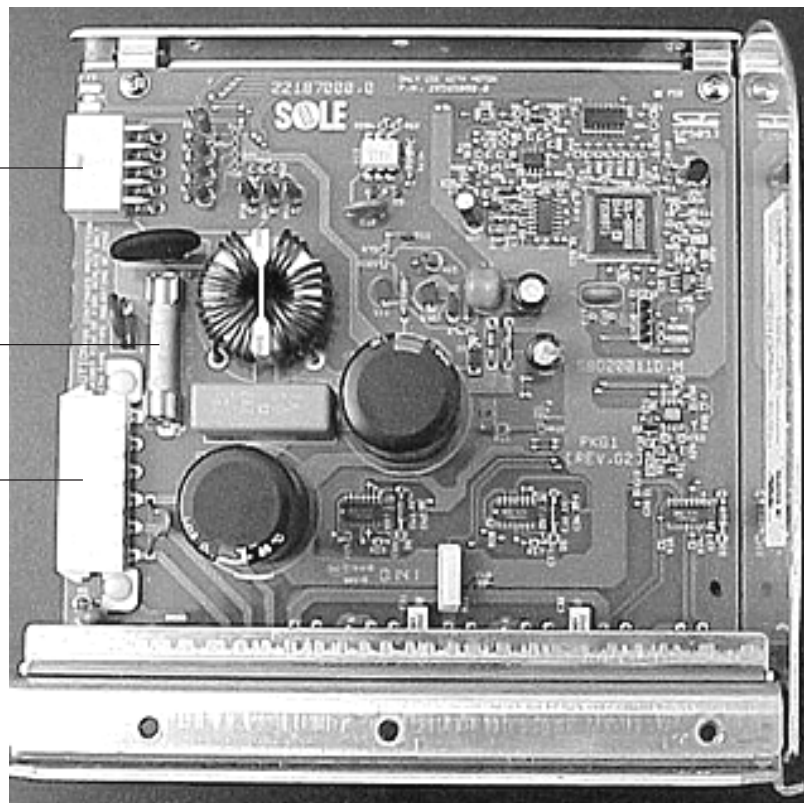

Washer completely inoperative.

Note: Always check wiring to the components.

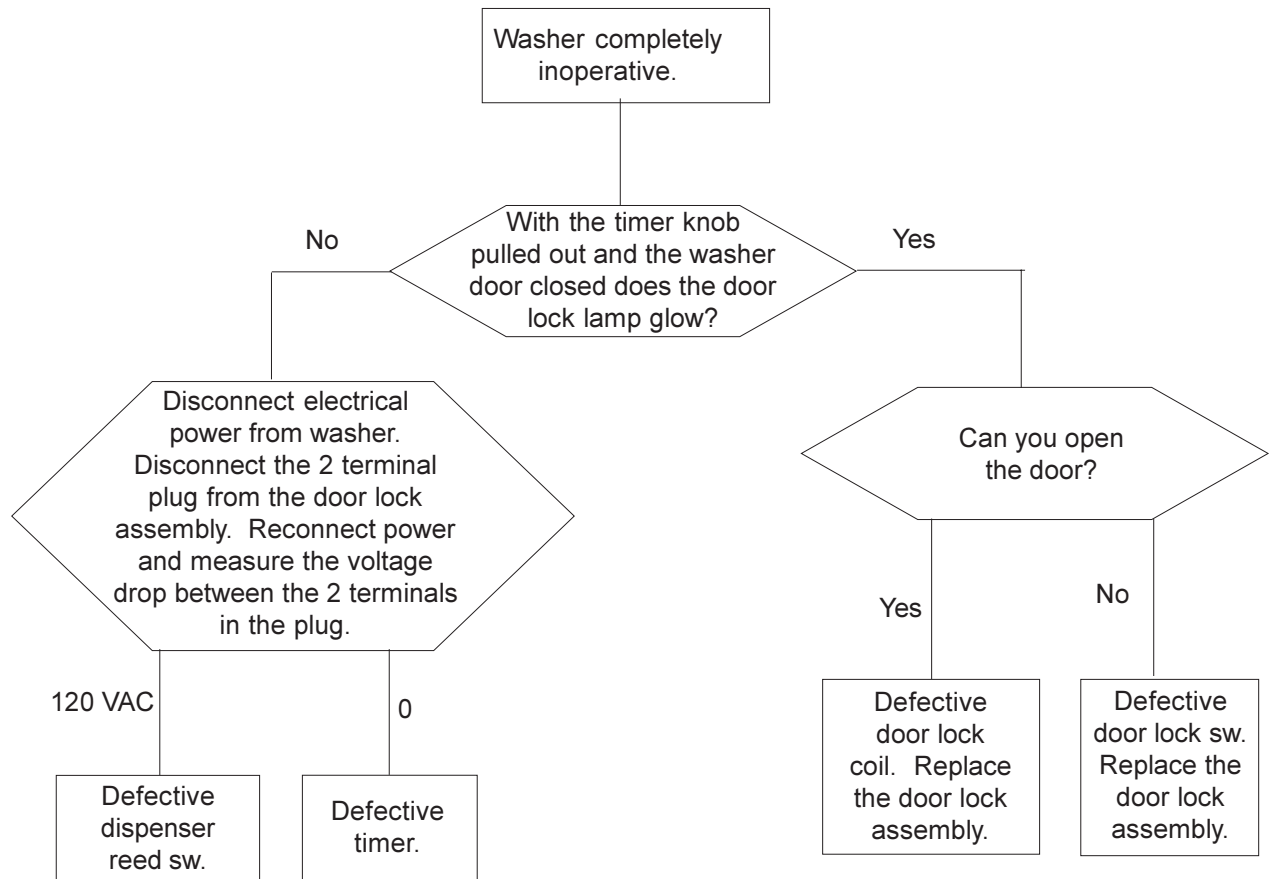

Timer does not advance.

Note: Always check wiring to the components.

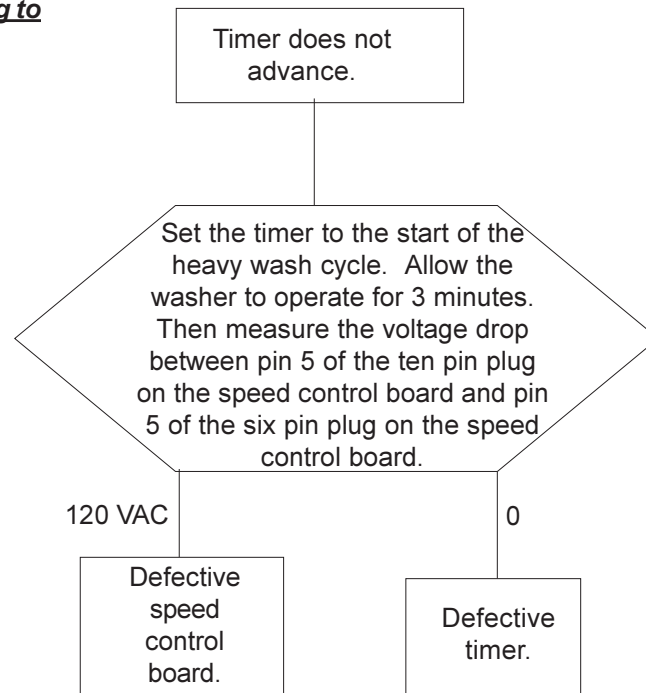

Washer does not drain.

Note: Always check wiring to the components.

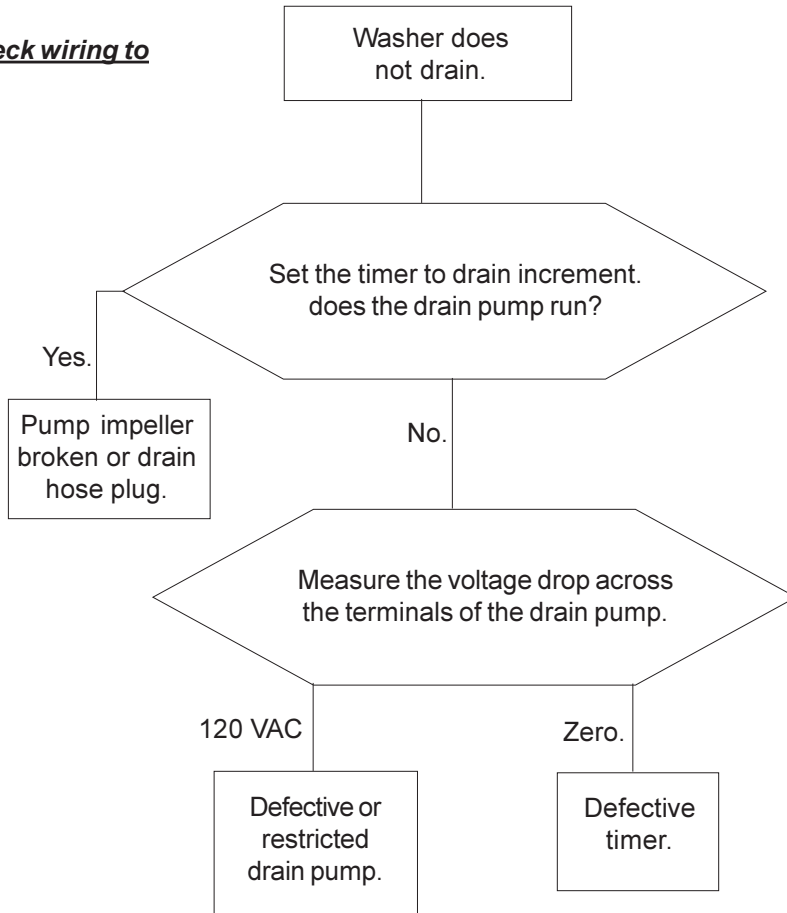

Extra rinse setting does not work.

Note: Always check wiring to the components.

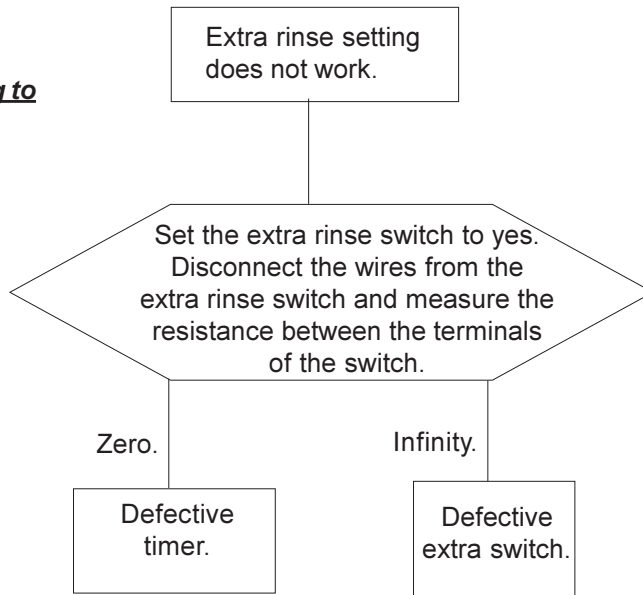

Bleach dispenser does not operate.

Note: Always check wiring to the components.

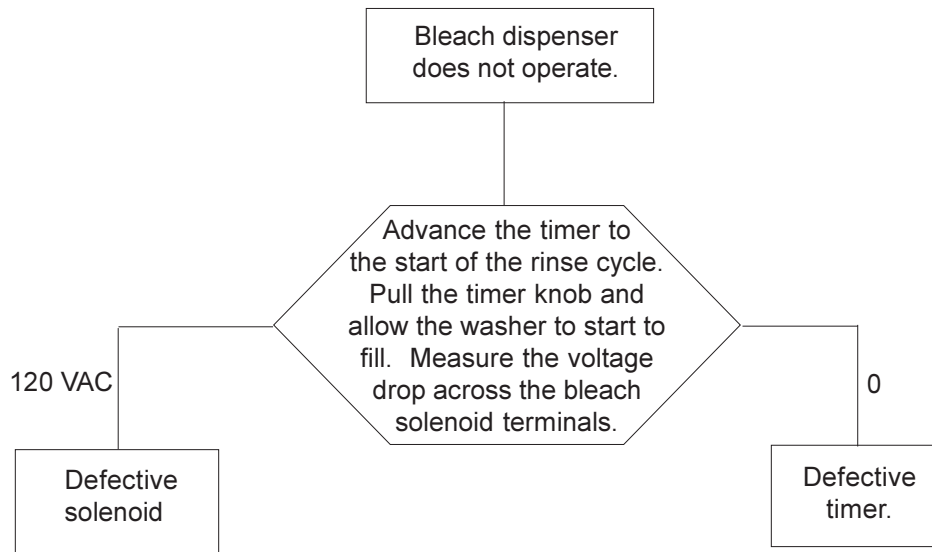

Softner dispenser does not operate.

Note: Always check wiring to the components.

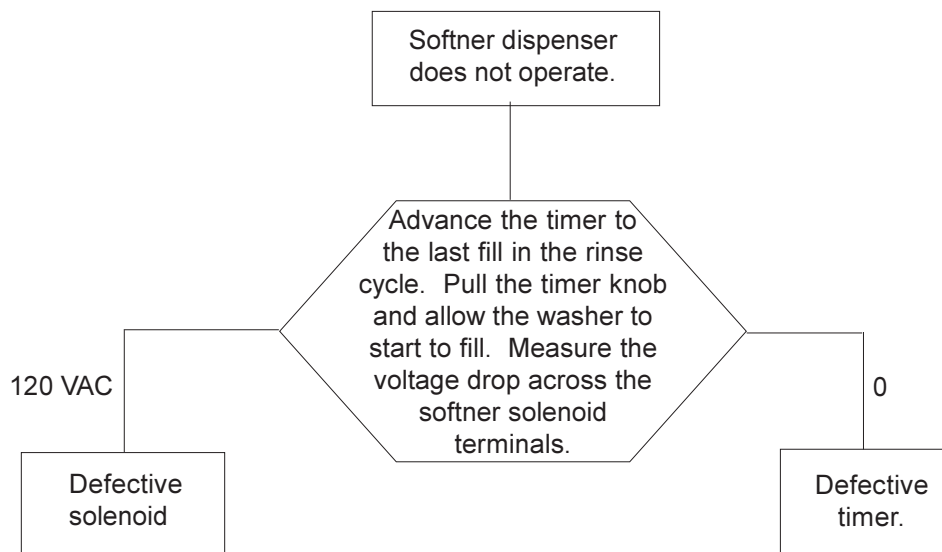

Drive motor does not turn.

Note: Always check wiring to the components.

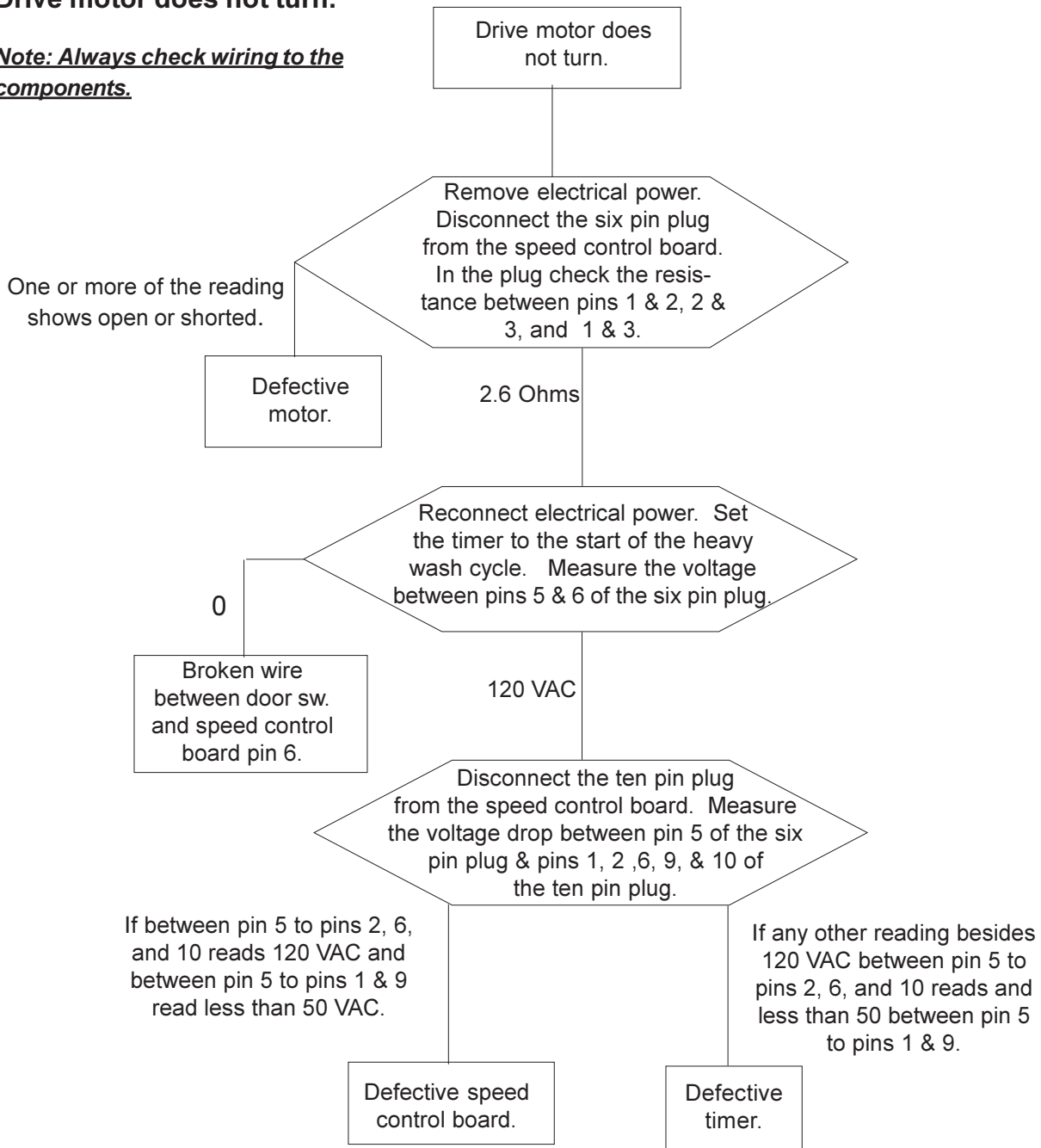

NOTE: If the drive motor windings check open or shorted check the fuse on the speed control board. If the fuse is open, replace the motor and speed control board.

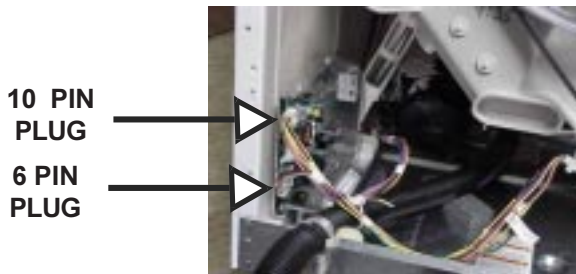

Drive motor spins but does not tumble.

Note: Always check wiring to the components.

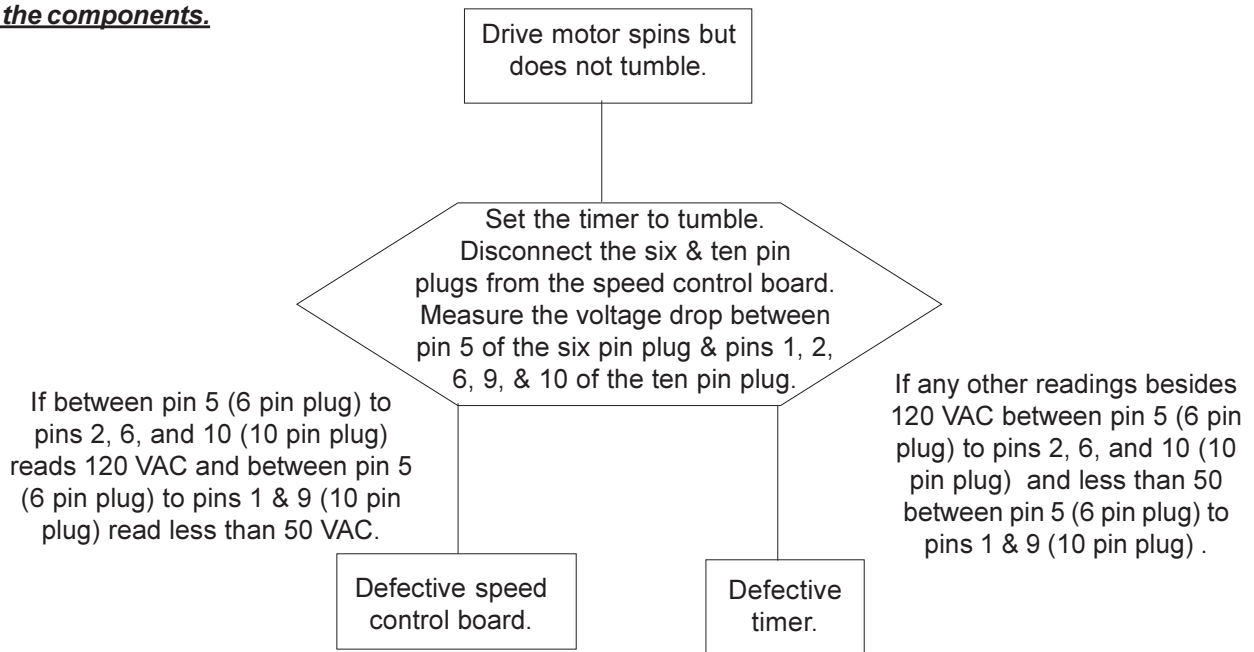

Drive motor tumbles but does not spin.

Note: Always check wiring to the components.

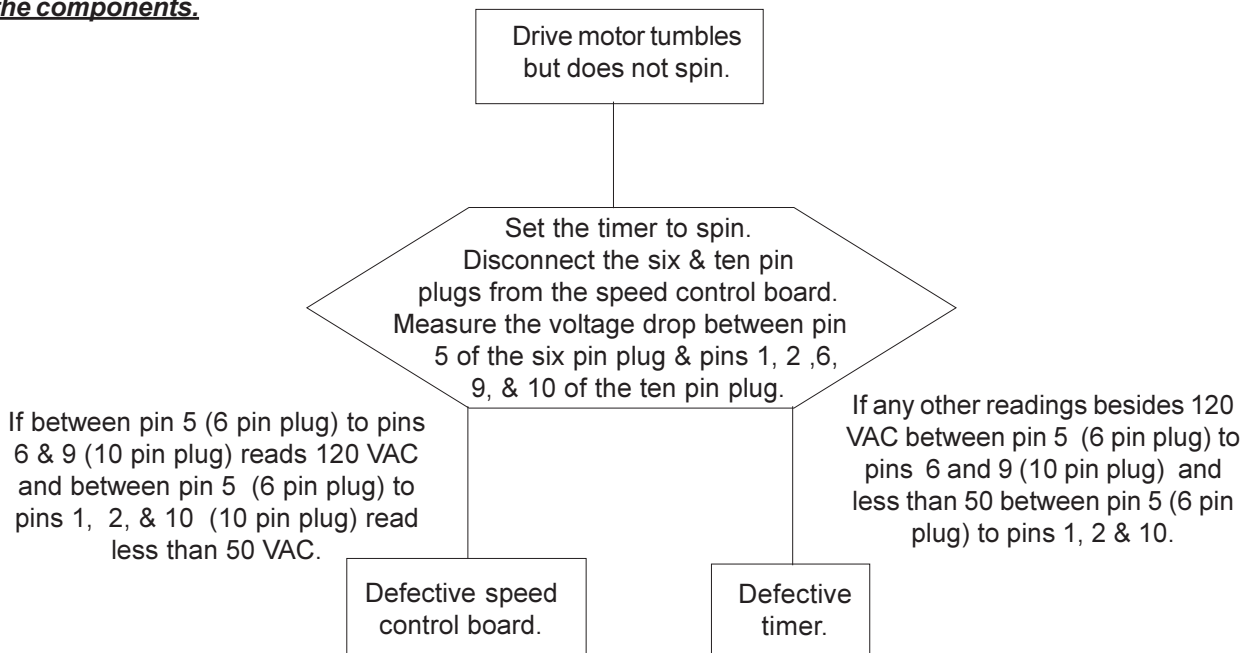

Drive motor tumbles very slowly in any timer position.

Note: Always check wiring to the components.

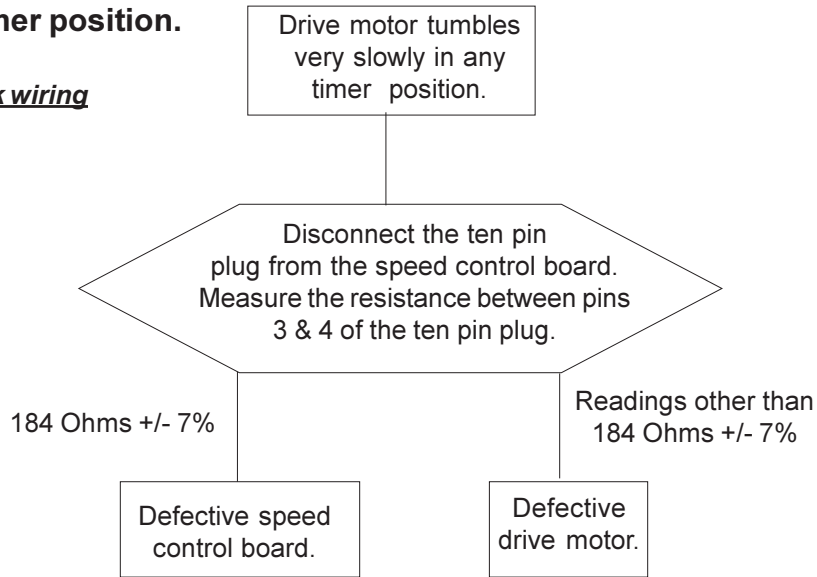

Models with normal and fast speed switch spinning at incorrect speed for switch setting

Note: Always check wiring to the components.

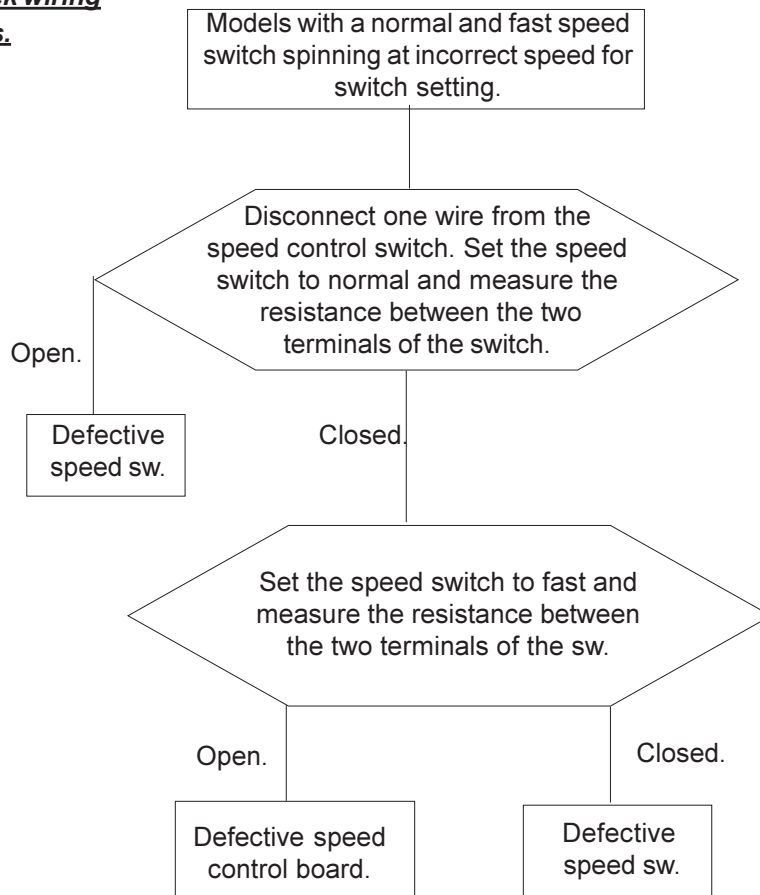

Models with slow, normal and fast speed switch spinning at incorrect speed for switch setting

Note: Always check wiring to the components.

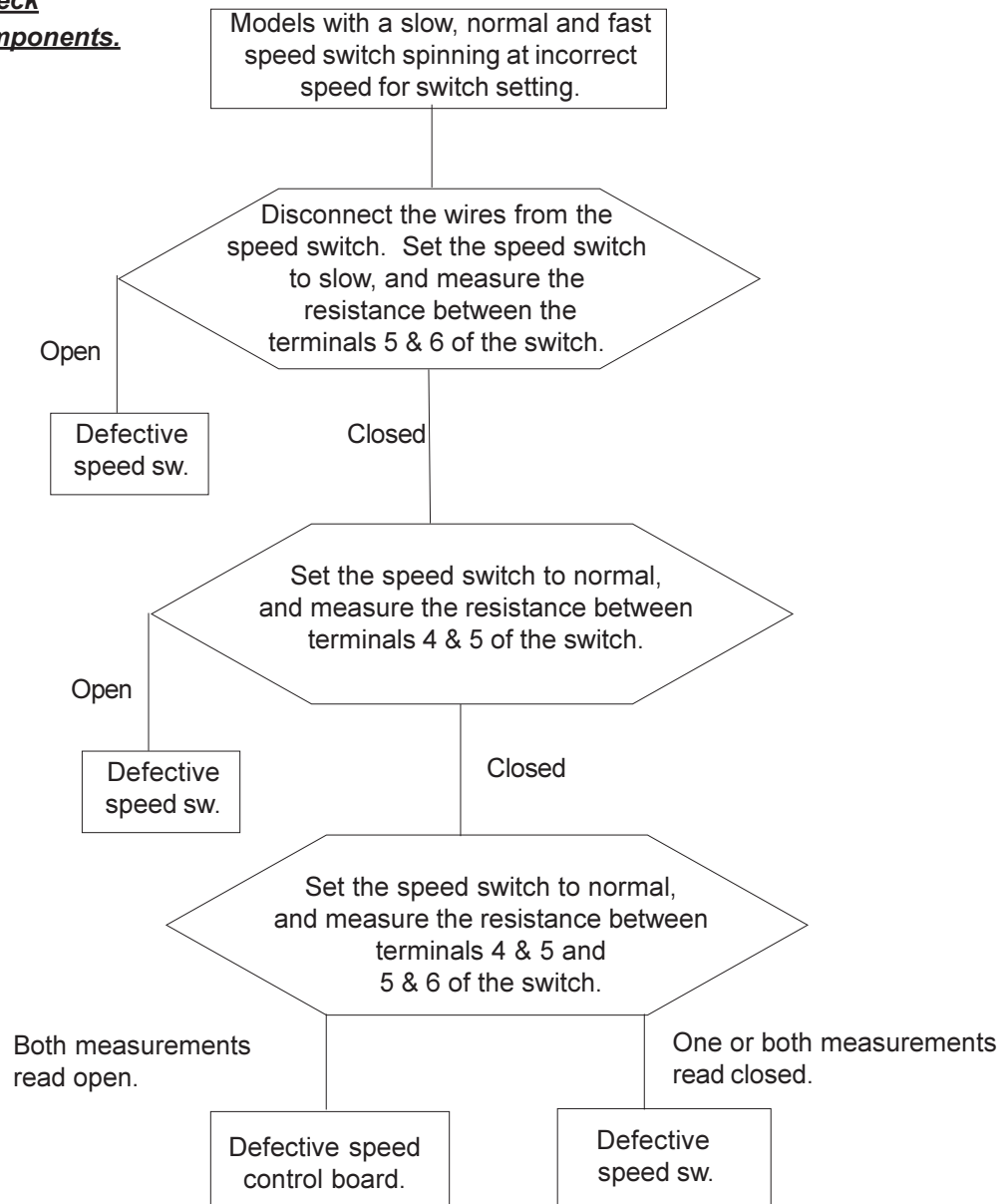

Water fill does not turn off

Note: Always check wiring to the components.

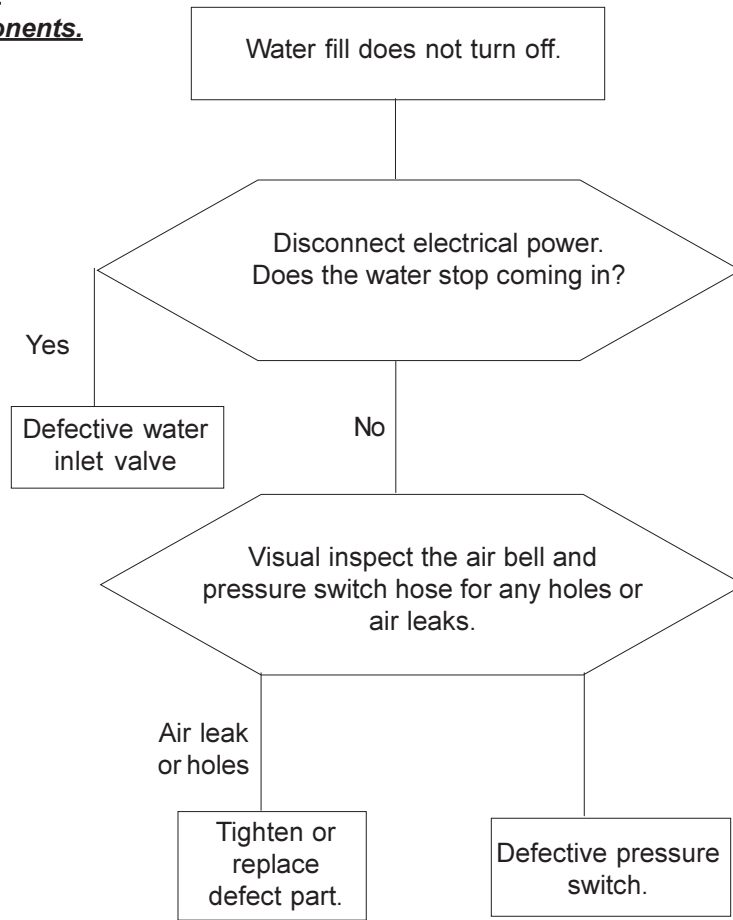

Incorrect water level

Note: Always check wiring to the components.

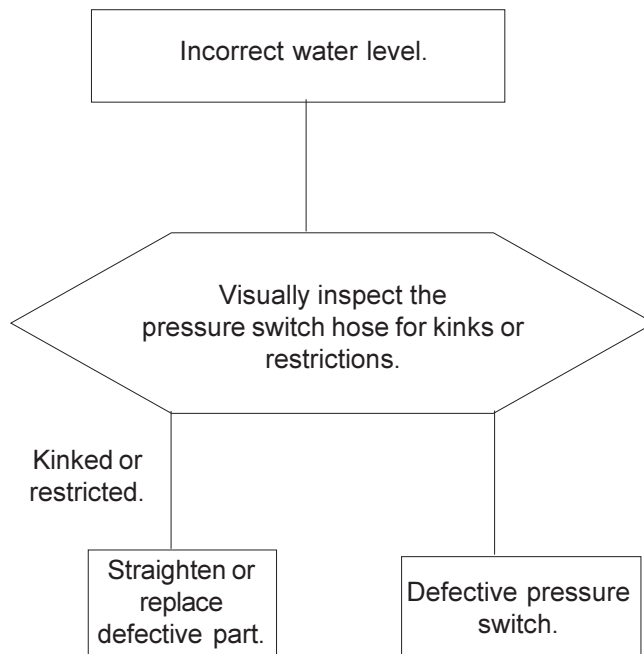

Slow water fill

Note: Always check wiring to the components.

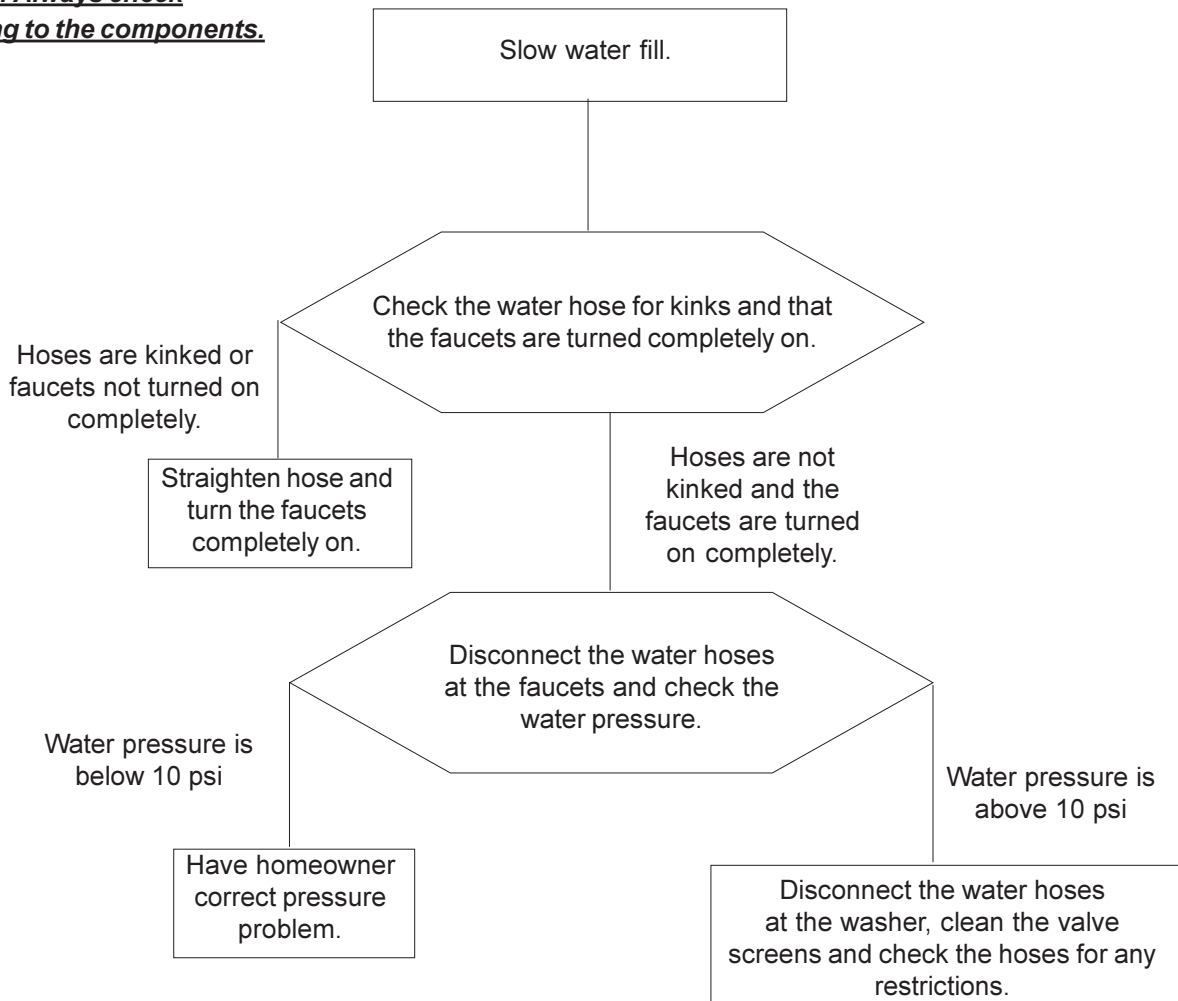

Washer will not fill in any setting of the temp switch

Note: Always check wiring to the components.

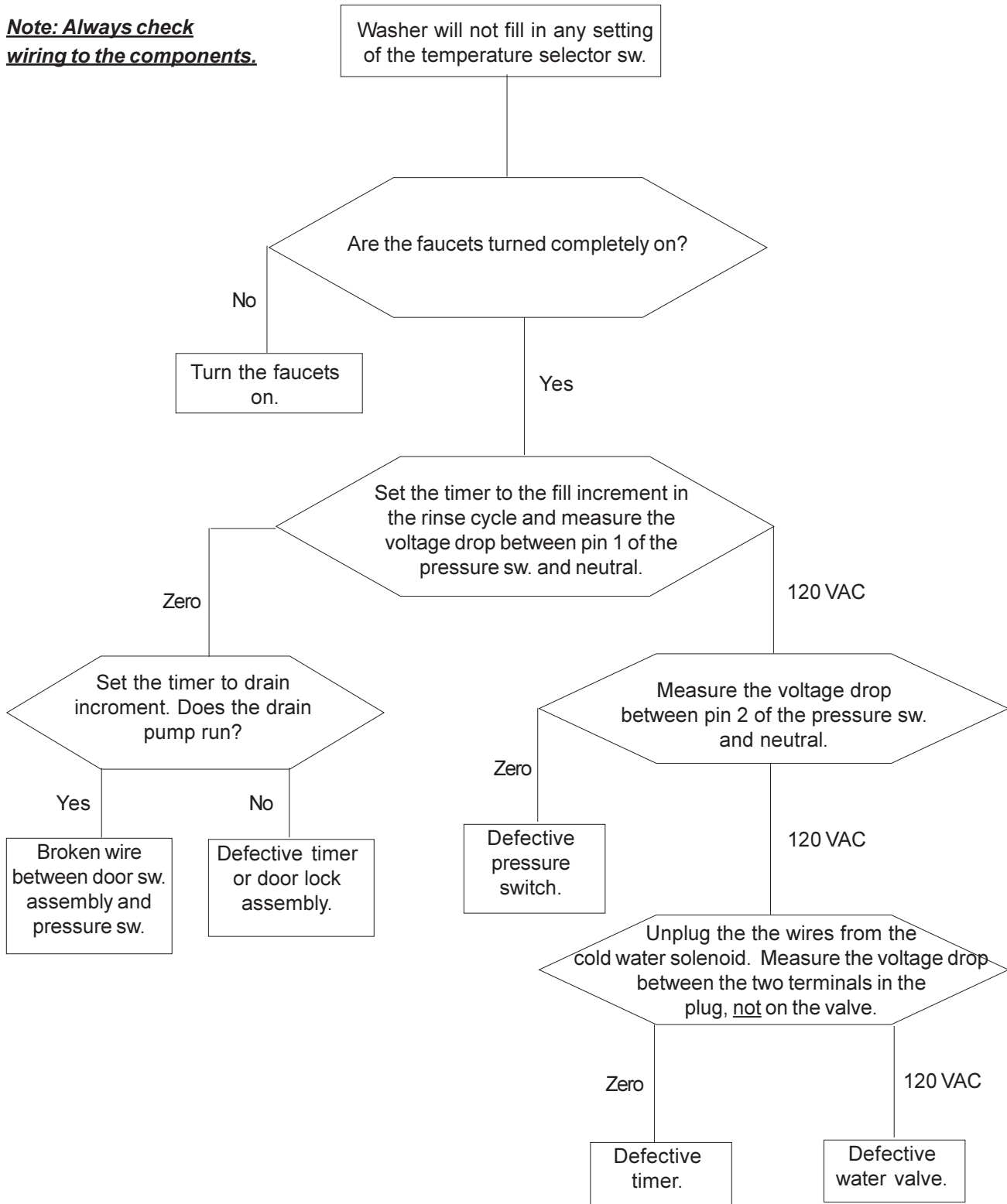

Washer will not fill in wash cycle, but will fill in rinse with the temp switch set to cold/cold

Note: Always check wiring to the components.

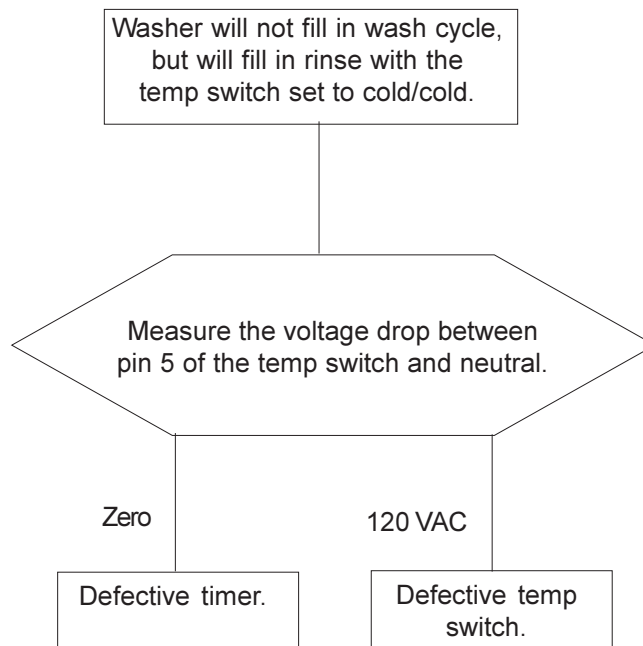

Washer will only fill with cold water in the wash cycle, with the temp switch set to warm/cold

Note: Always check wiring to the components.

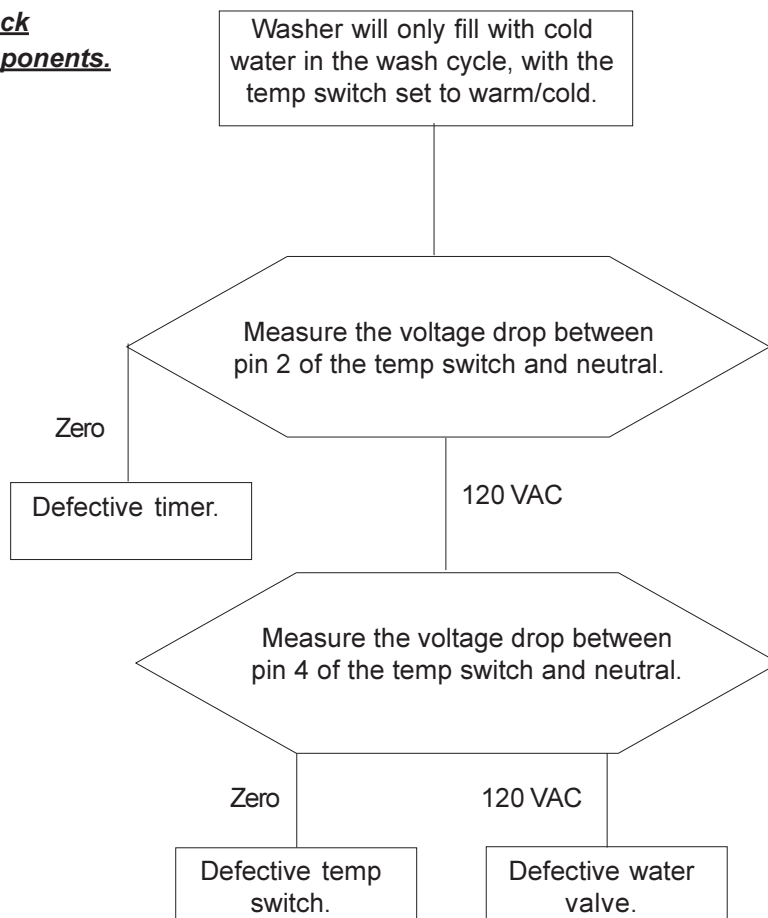

Water temperature is too hot or too cold in the wash cycle with the temp switch set to warm/warm

Note: Always check wiring to the components.

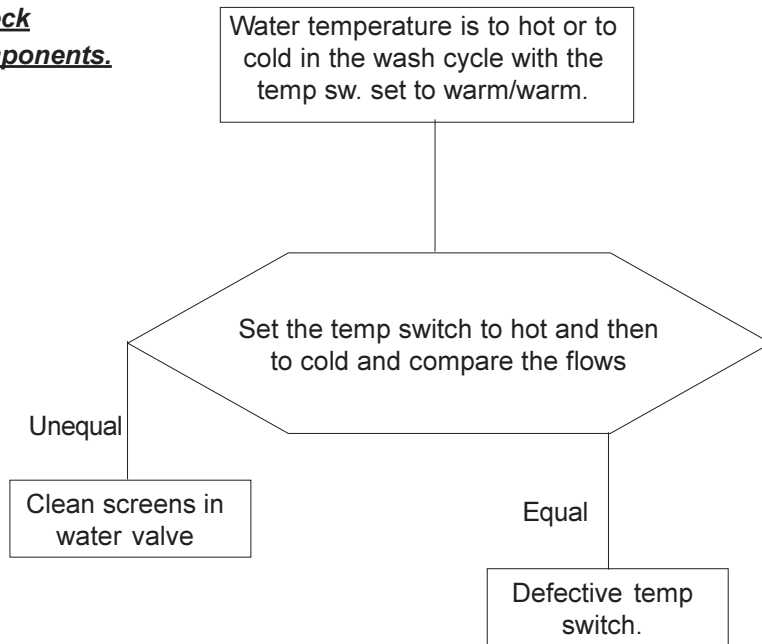

Washer will only fill with hot water in the wash cycle, with the temp switch set to warm/cold but does fill with cold in the rinse cycle.

Note: Always check wiring to the components.

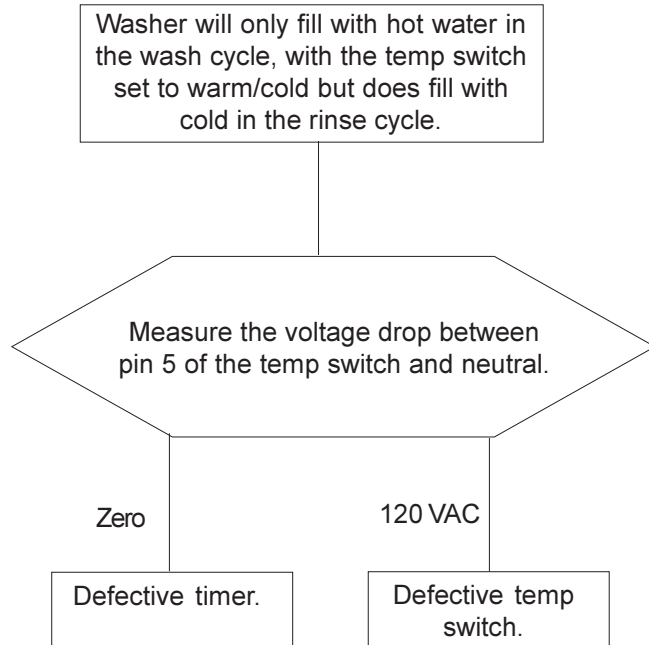

Auto temp control does not control the wash water temperature within specification.

Note: Always check wiring to the components.

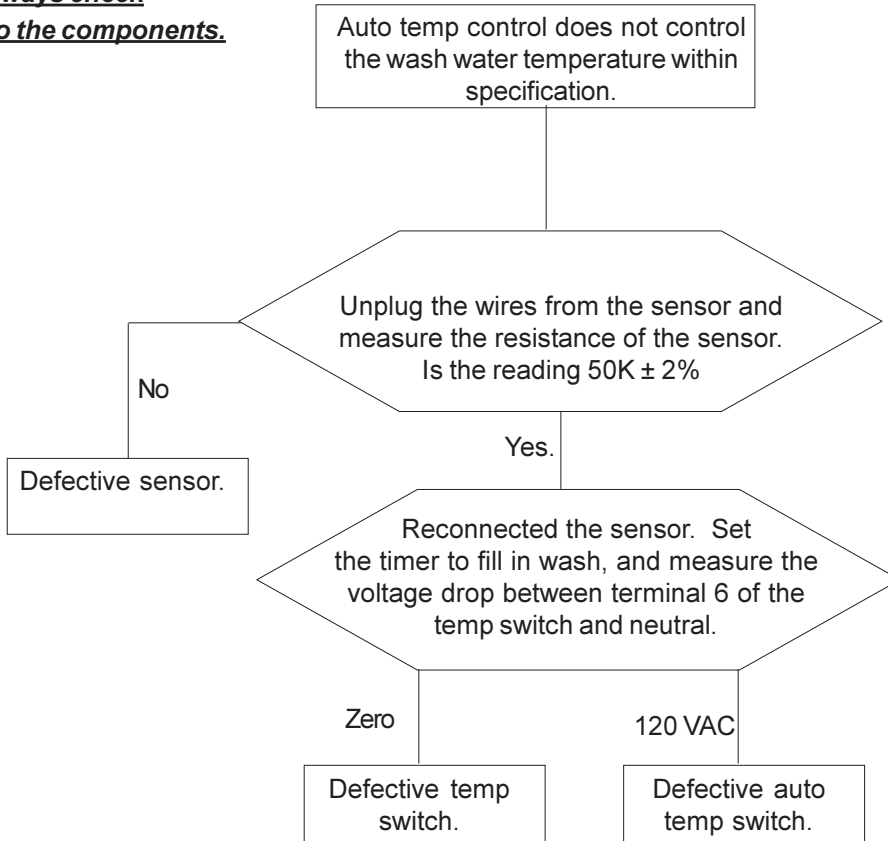

Door indicator lamp does not glow.

Note: Always check wiring to the components.

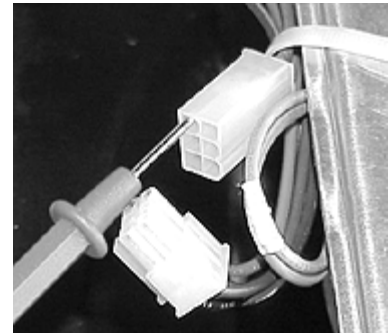
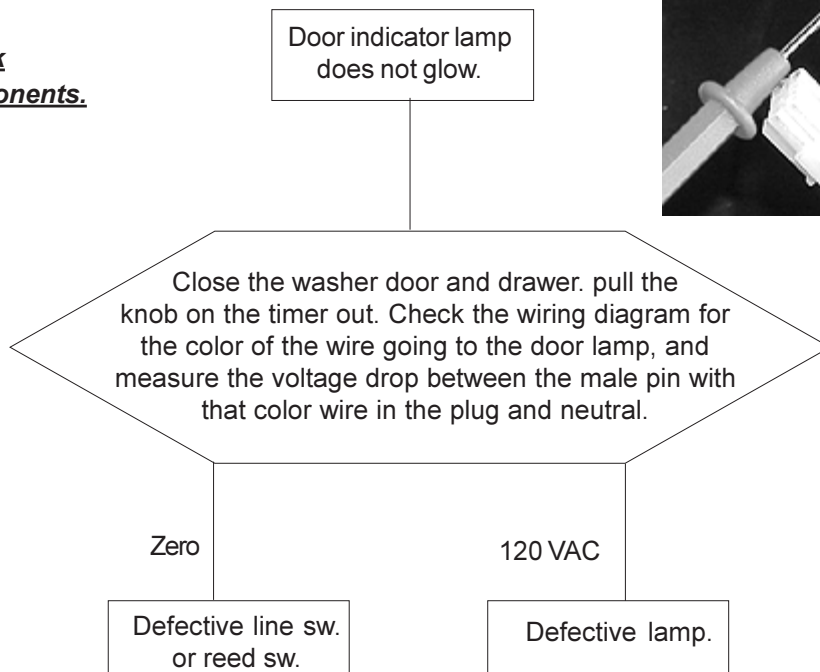

**Indicator lamp (wash, rinse or final spin)
does not glow.**

**Note: Always check
wiring to the components.**

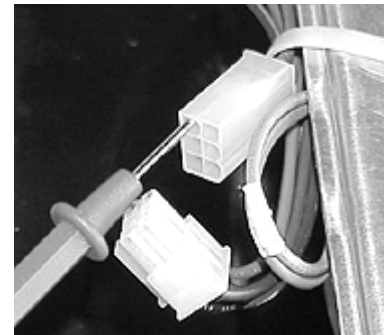
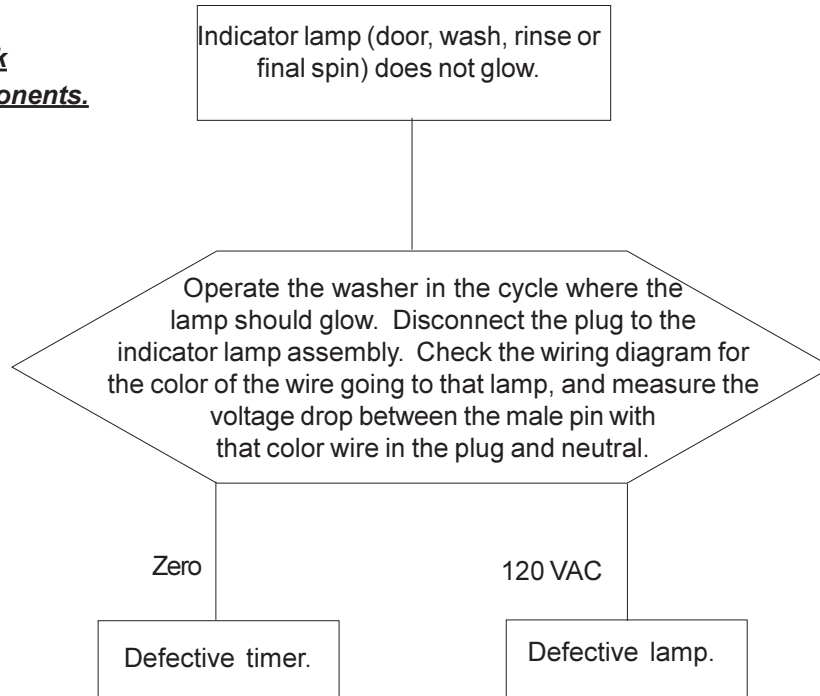

SECTION G - TEARDOWN

This section will describe how to remove components from the washer. Unless stated, reverse the procedure to reinstall the component.

⚠ WARNING Always remove electrical power from the washer when working in an area where electrical power is present.

⚠ WARNING Always turn the water off to the washer before disconnecting any hoses.

There are two styles of tumble action washers, those with the controls mounted on top in the rear (top console).



and those with the control mounted in the front (front console).



The difference in teardown is accessing the controls and removal of the main top.

Removing the detergent drawer:

1. Slide the safety latch lever to the right and pull the drawer out until it hit the stop.



2. Push down on the release tab and pull the drawer the rest of the way out.

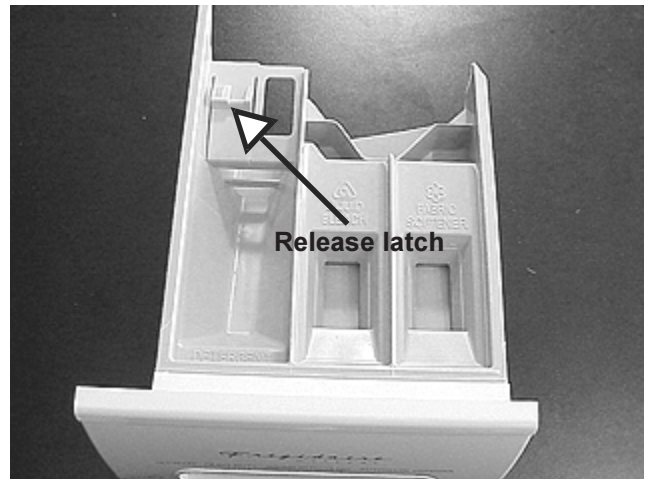

Detergent drawer disassembly:

1. Remove the drawer from the washer.
2. The liquid bleach and fabric softener inserts lift off. When reinstalling be sure to seat them properly and in the correct location.

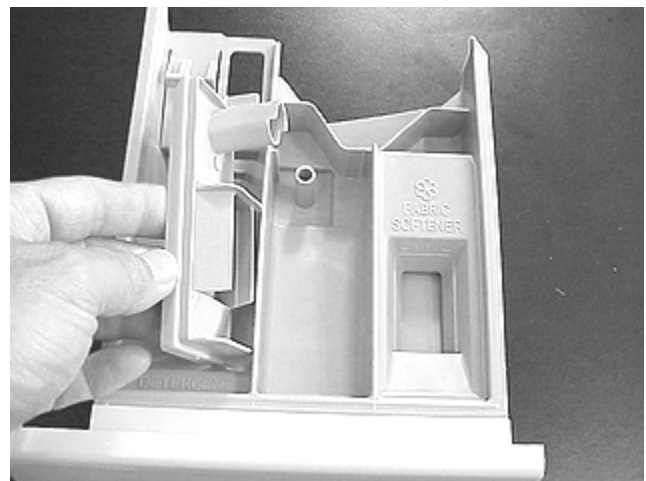

3. To remove the drawer front release the three tabs and pull the drawer front away from the body. When replacing the drawer front always remember to transfer the reed switch magnet.

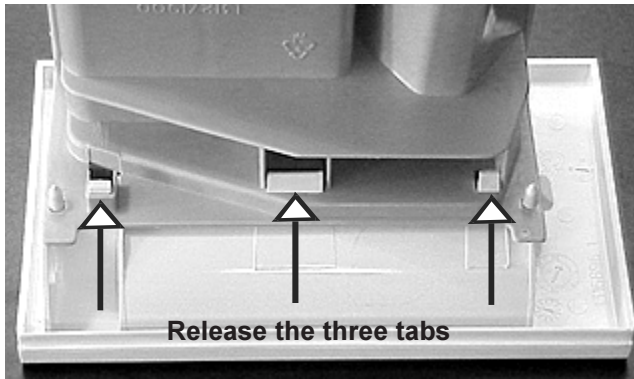

4. To remove the safety latch lever compress the spring by moving the lever completely to the left and lift the lever out.

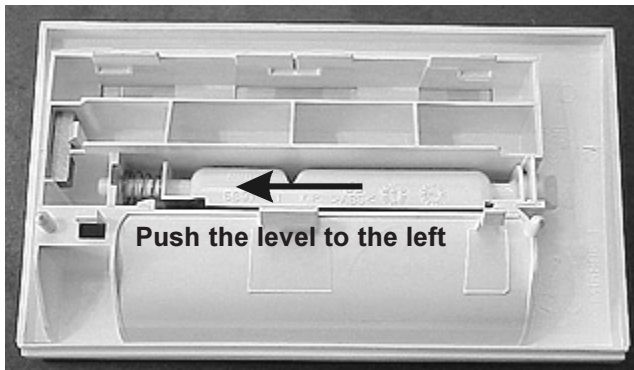

5. To remove the magnet pull the tab to the right.

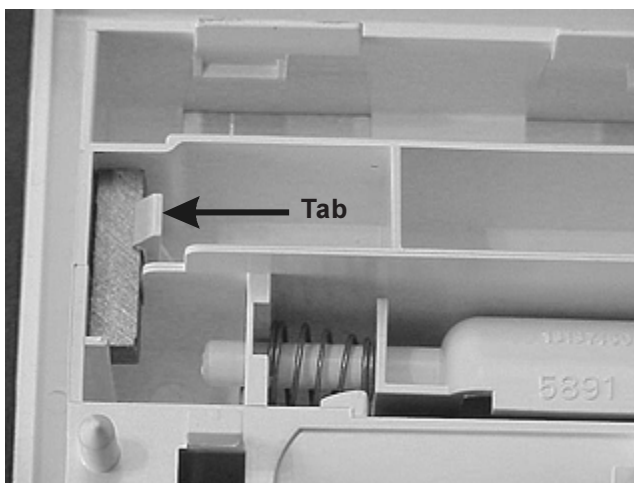

Removing the knobs:

1. All knobs, except the timer knob, pull off.
2. To remove the timer knob push the knob in and turn counter clockwise.

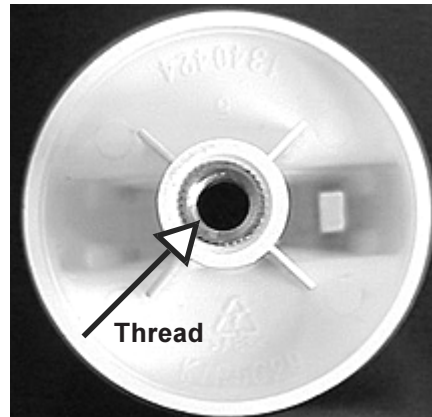

Removing timer bezel:

1. Remove the timer knob and pull the bezel off.

Removing the rear panel from the console (top console models):

1. Disconnect the washer from electrical supply.
2. Remove the six screws holding the panel to the console and lift the panel off.

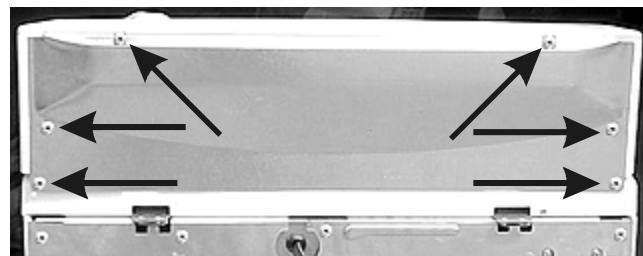

Removing the top panel (front console models):

The washer is shipped with a decorative top panel, but a galvanized panel is available if the washer is to be installed undercounter.

To remove the painted top panel:

1. Remove (4) screws on hinges securing top to cabinet.

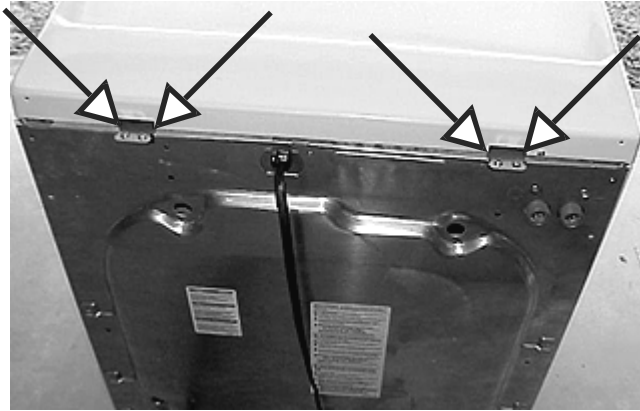

2. Slide top panel forward to disengage top from the top panel front mounting brackets.



To remove galvanized steel panel:

1. Remove the screws securing the galvanized steel panel to the top of the cabinet.

Removing the top panel (top console models):

1. Disconnect the washer from electrical supply.
2. Remove the rear panel from the console and disconnect the two plugs connecting the console to the washer.
3. Remove the four screws from the hinges and slide the top and console forward to release the top panel from the front brackets.

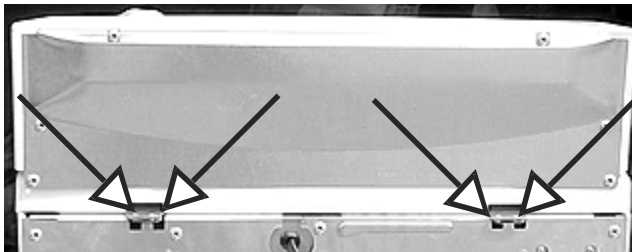

4. Lift the top and console off the washer.

Removing the top console skirt (top console models):

1. Disconnect the washer from electrical supply.
2. Remove the back panel from the console.
3. With a small screwdriver release the two tabs in the center and the two tabs on each end, that hold the front shield to the end caps and console mounting panel.

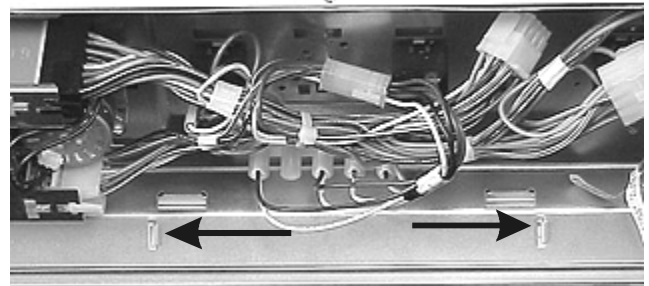

Removing the console (top console models):

1. Disconnect the washer from electrical supply.
2. Remove the back panel and skirt from the console and disconnect the two molex connectors in the wire harness that connect the console to the washer.
3. The console is held to the top panel by three slotted tabs molded into each end cap and two screws behind the skirt. Remove the two screws, slide the console forward and lift up.

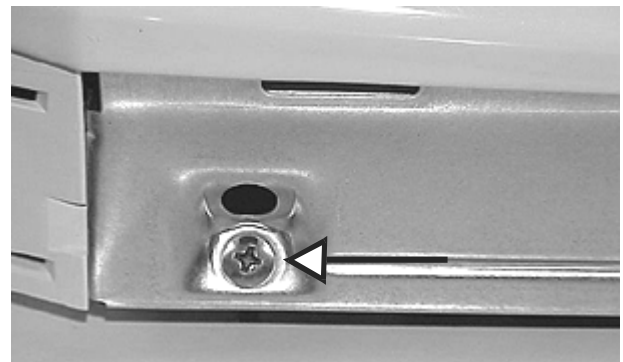

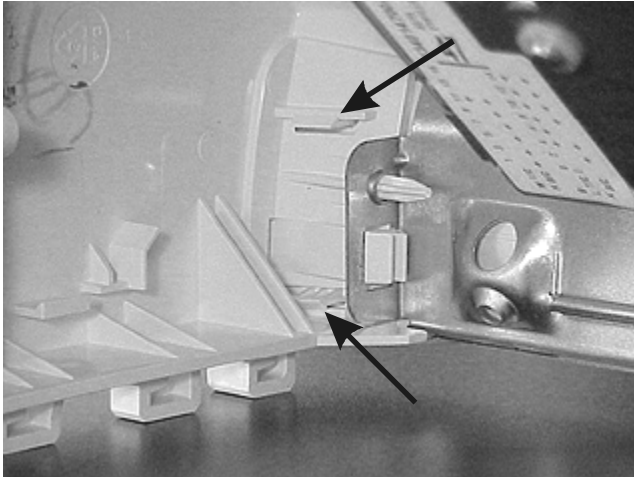

Removing the front panel from the console (top console models):

1. Disconnect the washer from electrical supply.
2. Remove the rear panel, front skirt and knobs from the console.
3. Remove the bottom screw holding the timer to the control mounting panel and lift the front panel off.

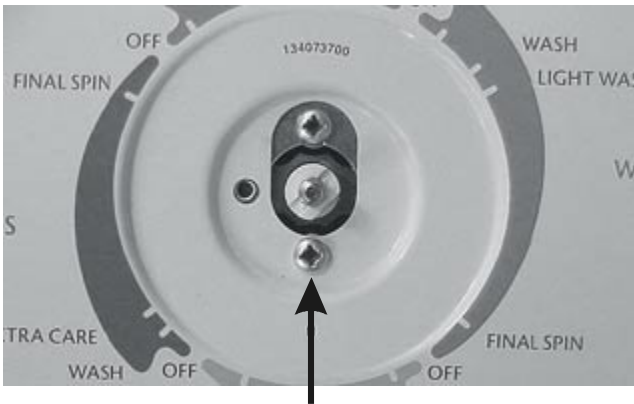

Removing the indicator lamp assembly (top console models):

1. Disconnect the washer from electrical supply.
2. Remove the front panel from the console and unplug the indicator light assembly harness.
3. Remove the one screw holding indicator light assembly to the control mounting panel and pull the assembly out the front.

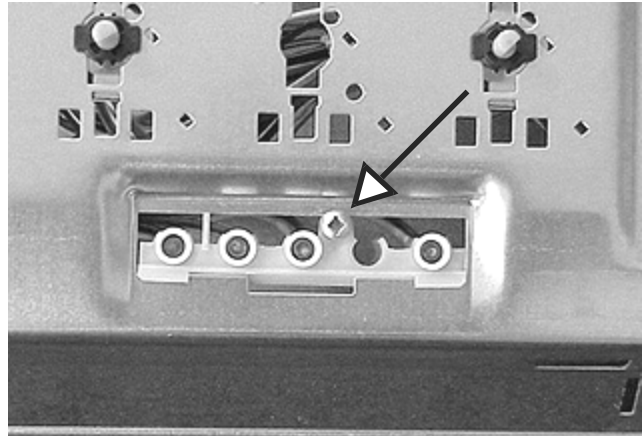

Removing the indicator lamp assembly (front console models):

1. Disconnect the washer from electrical supply.
2. Remove the main top and control panel.
3. Remove the one screw holding the lamp assembly to the control mounting panel.

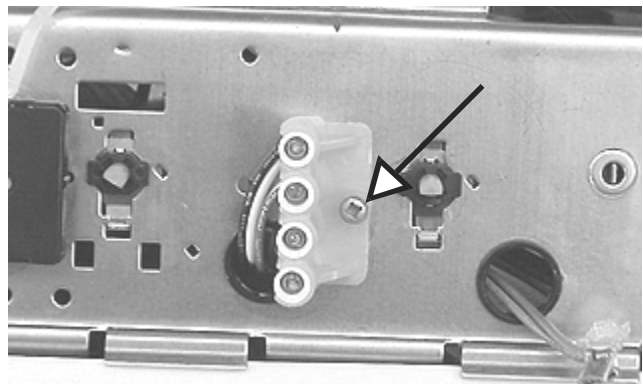

Removing the end caps (top console models):

1. Disconnect the washer from electrical supply.
2. Remove the console from the top panel.
3. Release the skirt from the end cap to be removed.
4. Squeeze the three locking tabs and pull the end cap off.

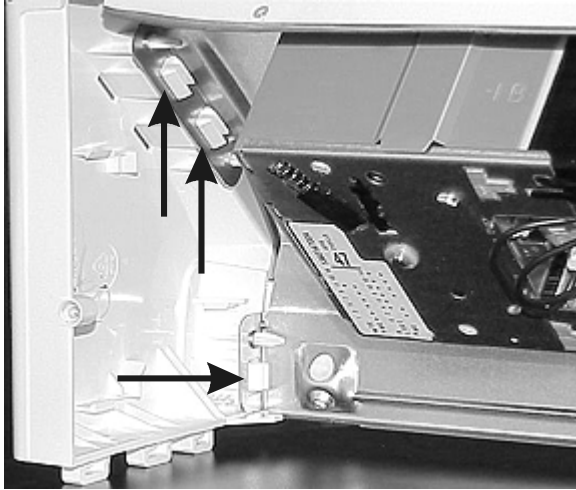

Removing the timer (top console models):

1. Disconnect the washer from electrical supply.
2. Remove the rear panel from the console, timer knob and bezel.
3. Remove the two screws holding the timer to the control mounting plate.
4. Pull the timer back and disconnect the two plugs.

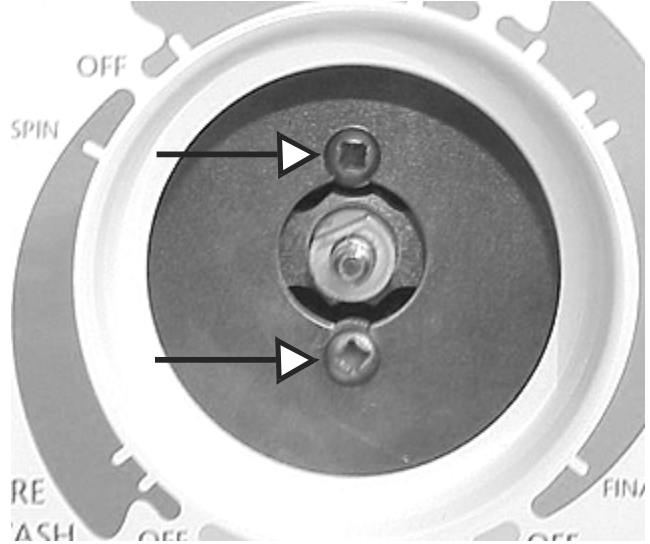

Removing the extra rinse or final spin speed switch (front console models):

1. Disconnect the washer from electrical supply.
2. Remove the main top and disconnect the wires from the switch.
3. Remove the knob, depress the locking tab and turn the switch body clockwise.

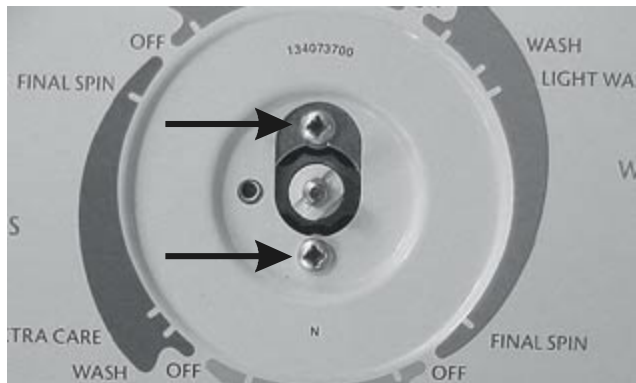

Removing the timer (front console models):

1. Disconnect the washer from electrical supply.
2. Remove the main top, timer knob and bezel.
3. Remove The two screws holding the timer to the control mounting plate.
4. Pull the timer back and disconnect the two plugs.

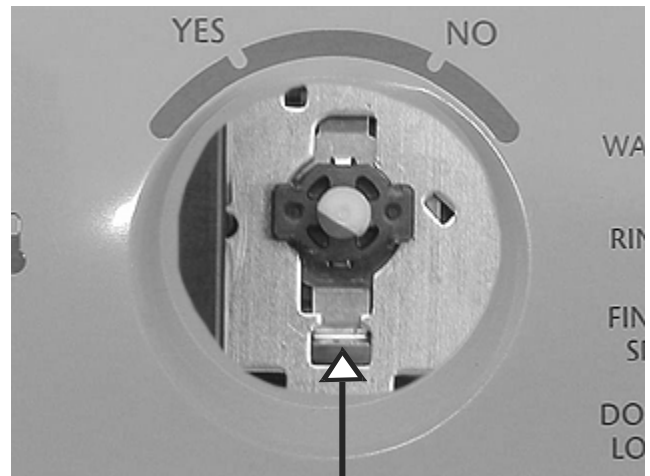

Removing the extra rinse, final spin speed, or end of cycle chime switch (top console models):

1. Disconnect the washer from electrical supply.
2. Remove the rear panel from the console and disconnect the wires from the switch.

- Remove the knob, depress the locking tab and turn the switch body clockwise.

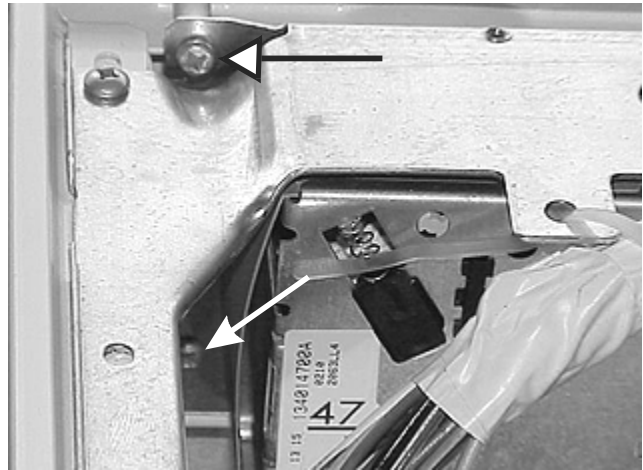
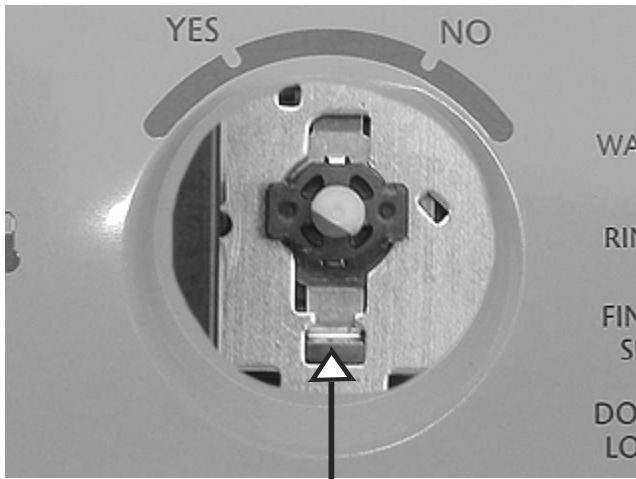

two in the center,

Removing the control panel (front console models):

- Disconnect the washer from electrical supply.
- Remove the main top and detergent drawer.
- Remove the one screw behind the detergent drawer holding the control panel to the control mounting panel.

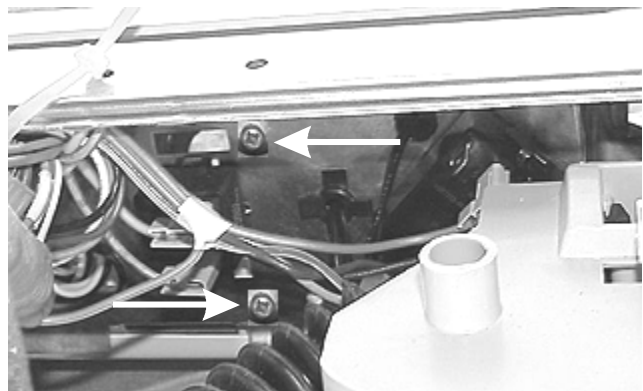

and one on the right side.

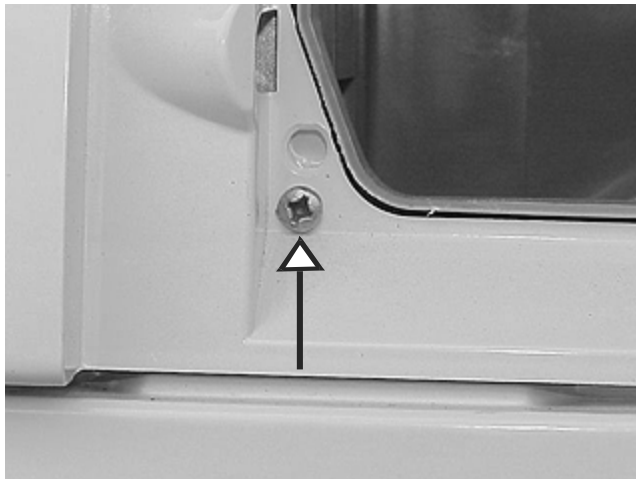

- Remove the five screws from the control mounting plate holding the control panel to the mounting plate. Two on the right side beside the timer,

- Pull the control panel forward and disconnect the two wires from the end of cycle chime.

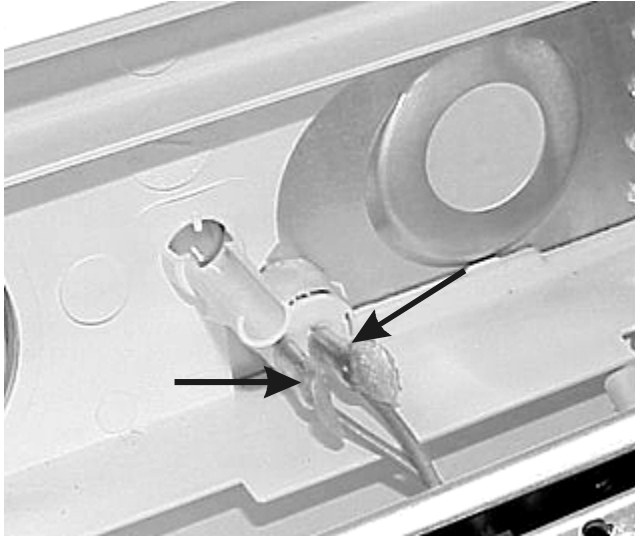

6. Unsnap the drawer reed switch from the control panel and lift the panel off.

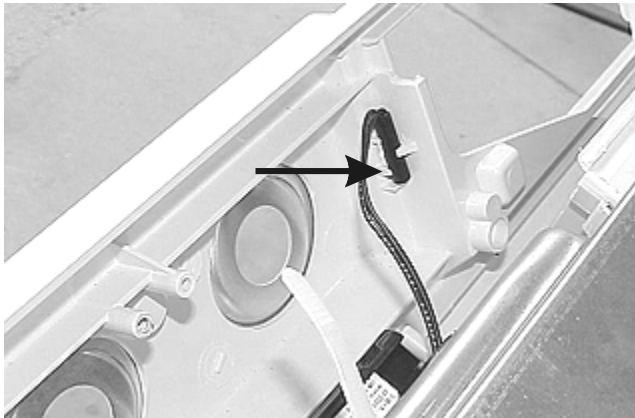

Removing the front panel (top console models):

1. Disconnect the washer from electrical supply.
2. Remove the top panel.
3. Remove the screw behind the detergent drawer panel.

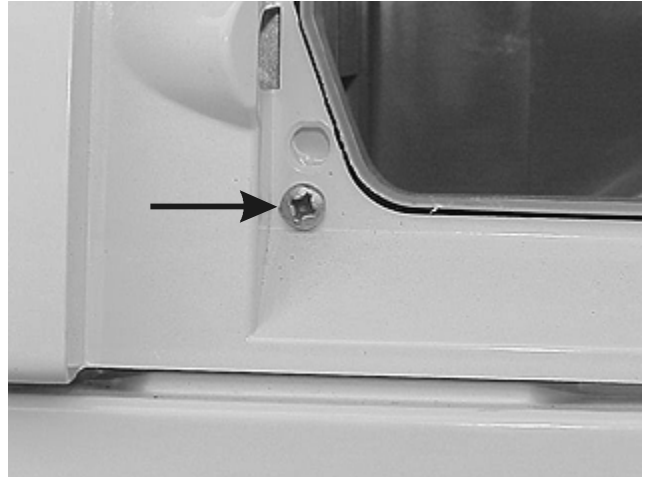

4. Remove the (4) screws holding the front panel to the control mounting panel. One on each end and two in the middle.

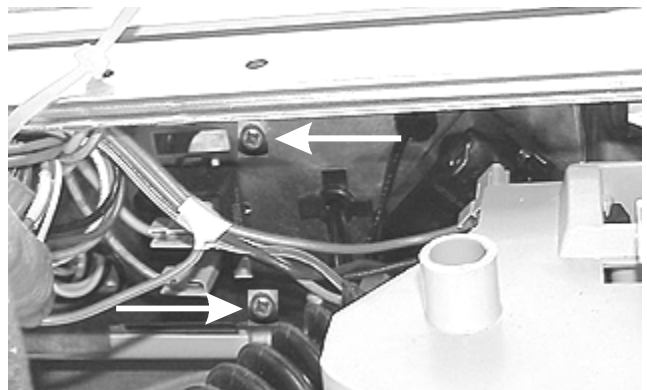
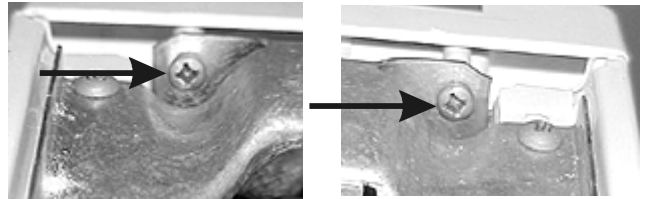

Removing end of chime switch (front console models):

1. Disconnect the washer from electrical supply.
2. Remove the main top and the control panel.
3. Disconnect the wires, squeeze the tabs on the side of the switch and push it out front.

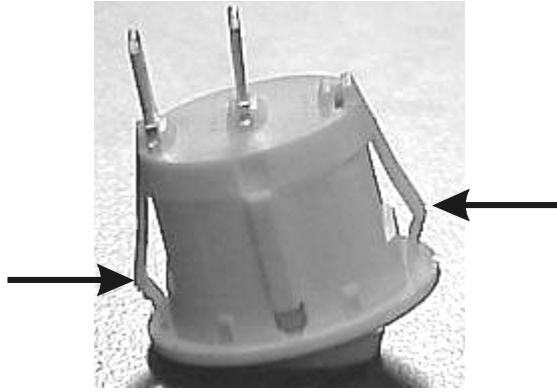

Removing the reed switch (front console models):

1. Disconnect the washer from electrical supply.
2. Remove the main top and the control panel.
3. Disconnect the plug from the wiring harness that connects the reed switch and lift the reed switch out.

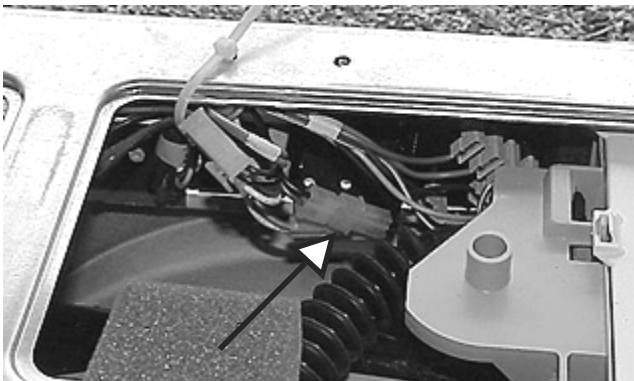

Removing the buzzer (front console models):

1. Disconnect the washer from electrical supply.
2. Remove the top panel and control panel.
3. Unplug the wiring harness from the buzzer.
4. Pull forward and turn the buzzer 90 degrees counter clockwise to release it from the control mounting panel.

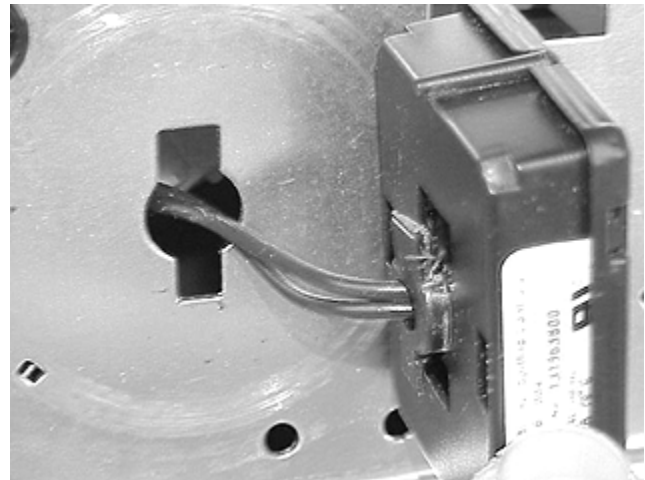

Removing the buzzer (top console models):

1. Disconnect the washer from electrical supply.
2. Remove the top panel and front panel.
3. Unplug the wiring harness from the buzzer.
4. Pull forward and turn the buzzer 90 degrees counter clockwise to release it from the control mounting panel.

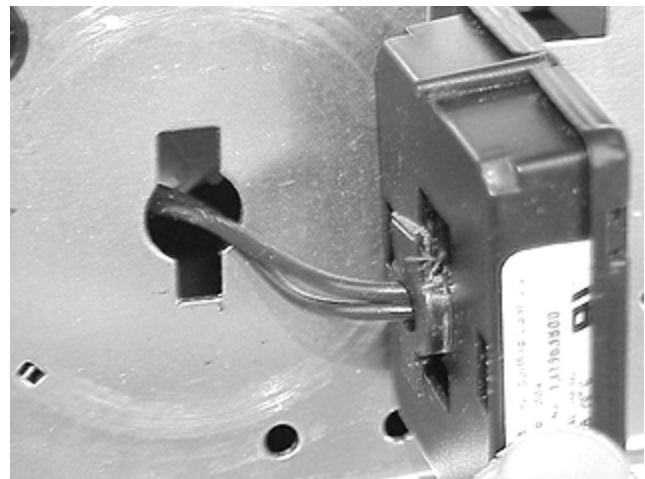

Removing the ATC temp switch (front console models):

1. Disconnect the washer from electrical supply.
2. Remove the main top and disconnect the wires from the temp switch.

3. Remove the knobs, dispenser drawer and control panel.
4. Turn the buzzer 90 degrees to expose the locking tab, depress the locking tab and turn the switch clockwise.



Removing the ATC temp switch (top console models):

1. Disconnect the washer from electrical supply.
2. Remove the back panel from the backguard and temp switch knob. Disconnect the wires from the temp switch.
3. From the back of the backguard release the switch locking tab with a small screwdriver and turn the switch clockwise.

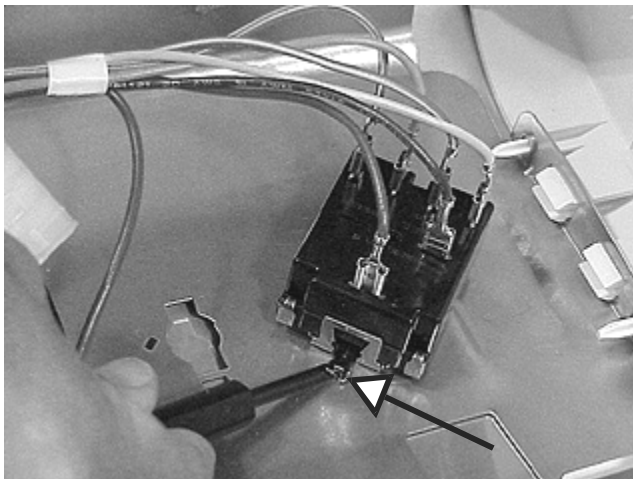

Removing the front service panel:

1. The front service panel is held in place by two nylon pins at the top and two 1/4" hex screws located at each bottom corner.

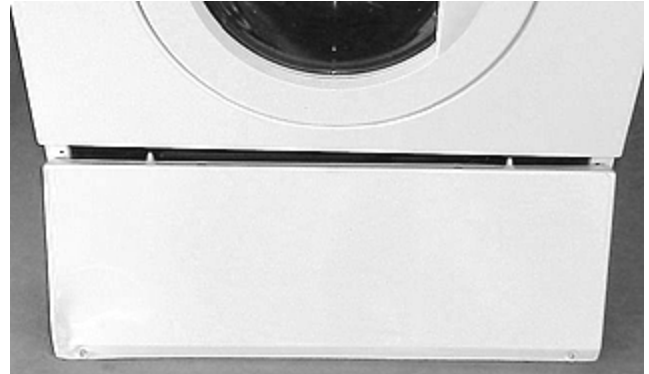

2. Remove the two 1/4" hex screws located at each bottom corner. Pull down and forward.

To remove loading door or door glass:

1. Remove the door by removing door to hinge mounting screws (2).

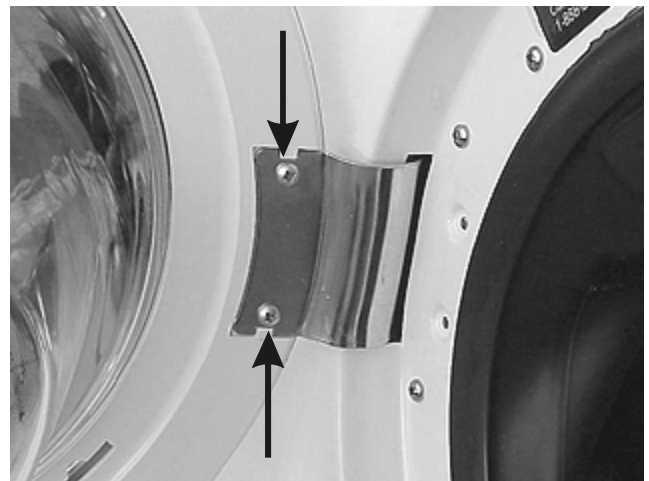

2. The front cover is held to the rear cover by two screws and two spots of glue on the two spacer posts on the hinge side. Remove the two screws.

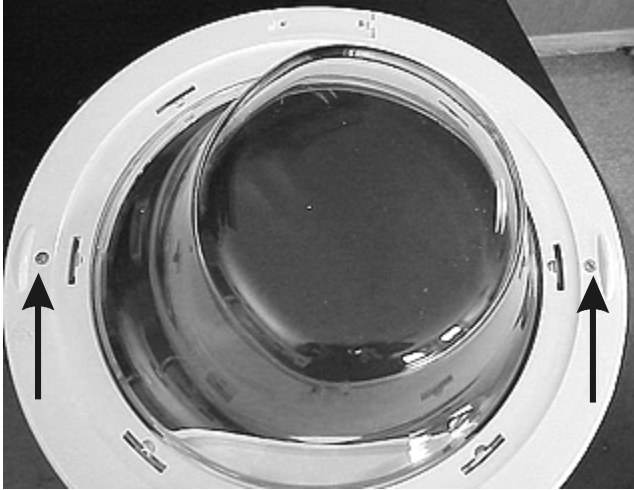

3. Starting at the latch side gently pry the cover off. The glue spots will snap at the joints without breaking the panels. When reinstalling put a drop of super glue on each post



5. Reinstall the glass into door frame by pressing into place. Note locating notches on glass which ensures correct position.

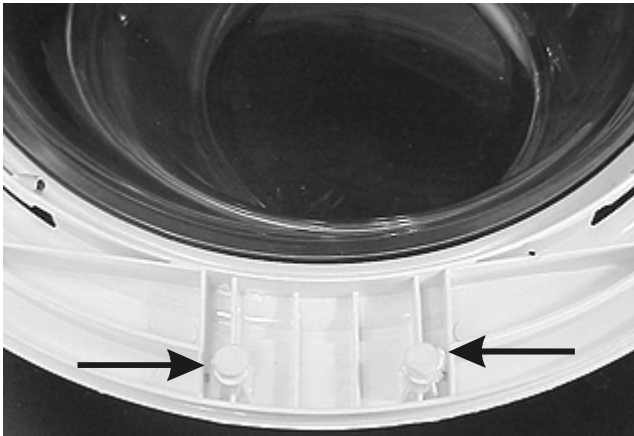

4. The glass is held in place by three molded tabs in the rear door cover. To remove the glass grab the edge of the cover by the tab and twist it away from the glass.

To remove door strike:

1. Open loading door.
2. Remove (2) screws which secure strike to inner door panel.

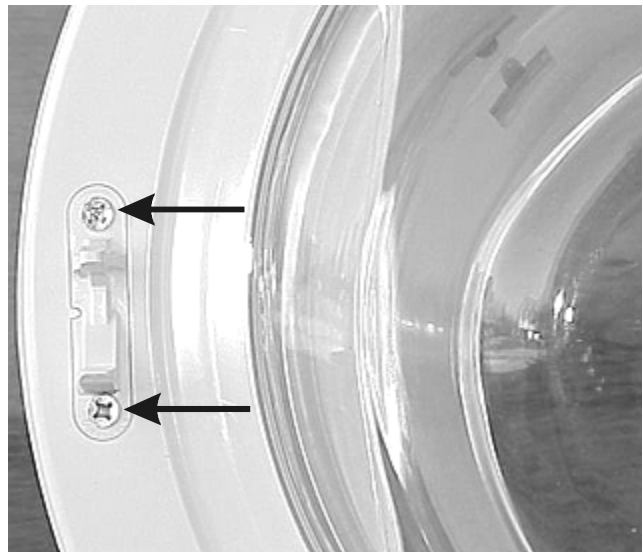

To remove door hinge:

1. Disconnect washer from electrical supply.
2. Remove door by removing (2) door to hinge mounting screws.

3. Pull the left side of the bellows (door boot) loose to gain access to the rear of the hinge. NOTE: Boot is glued in spots around perimeter.

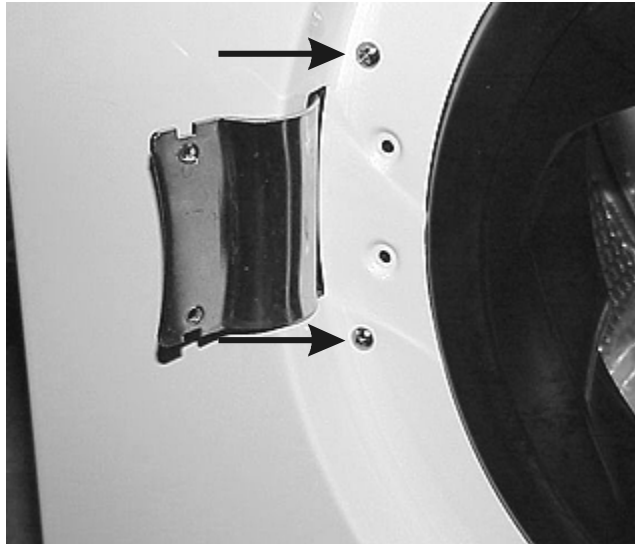

4. Reach up from the bottom and hold the switch while removing the two screws from the front. Then drop the switch assembly out the bottom.



4. Slip hand through opening between front panel and boot and hold hinge while removing the two hinge mounting screws.
5. Pull hinge arm out of slot in front panel back into the washer and remove hinge between the front frame and boot. NOTE: When reinstalling boot edge, reglue in spots with super glue.

NOTE: The connectors can be disconnected from the bottom, but it is more difficult.

Removing the door safety switch:

Removing the bellows (door boot):

1. Disconnect washer from electrical supply.
2. Remove top panel and front service panel.
3. Reaching in from the top unplug the three connectors from the door switch.

1. If the machine has a dryer stacked on top, or is positioned in such a way that it would be difficult to move, you will be better off leaving it where it is. However, if it is possible, it is easier to do this job if the machine can be leaned back against a wall (protect the wall with cloth or rug). By leaning it back, the tubs will hang back from the (non-removable) front panel and you will have increased space to work. If leaning it back is not possible, then a 6 or 8 inch block of wood can be wedge between the front panel and the tub to hold the tub back out of the way.



2. The boot is attached to a lip around the perimeter of the opening on the front panel and is glued on in spots about three inches apart, all the way around. Use a razor blade and carefully slice the glued spots on the boot away from the front panel.



3. Once the boot is loose from the front panel, push it into the opening of the tub and out of the way.

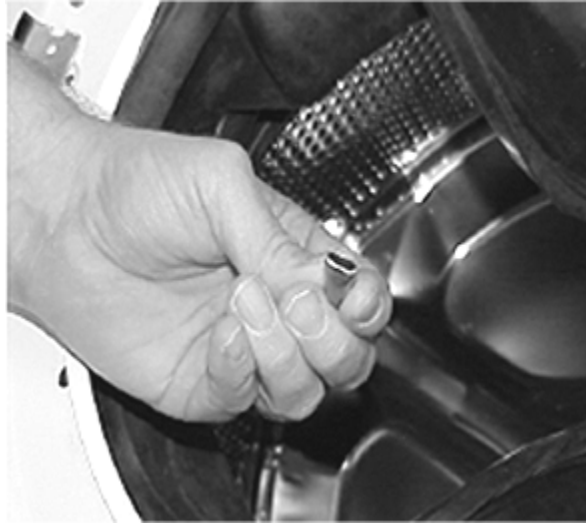

At this point, if the machine is not leaning back, take your block of wood and while pushing back on the tub through the opening, wedge the block between the front panel and the tub about ten inches to the bottom - right of the opening. This will afford you more space to work with the boot.

4. The boot is still attached to the water inlet duct that is located just inside the front panel at the upper left corner from the opening. This is where the water, soap, bleach and fabric softener enter the tub. To remove (and later on, reattach) the clamp holding this in place on the end of the duct make a tool from a three inch piece of 3/8 inch soft copper tubing by flattening one end somewhat, so that it can be slipped over the twisted ends of the clamp.

Twist the tube counterclockwise to open the wire clamp. Remove the clamp and pull the boot free from the duct.

5. Using both hands, grab onto the boot at the top of the opening to the tub and pull downward and toward you with slow steady pressure. As the boot is pulled free from the outer lip of the tub (at the top), the coiled spring that holds the boot from the groove behind the lip around the opening to the front shell will become visible. You can either continue pulling on the boot until it comes off or you can hook the spring (with a piece of coat hanger fashioned into a hook) and pull it off and then pull the boot off separately.

Reinstalling or replacing the boot:

1. The boot has a lip that will have to be folded into the groove behind the lip on the front tub shell. To start, examine the boot and locate the groove in front of the lip that corresponds to the similar lip and tab on the tub shell.
2. Using some liquid dishwasher soap sparingly lubricate this groove on the boot to make it easier to slip onto the lip of the tub shell.



3. Once the groove in the boot is lubricated with soap, locate the arrow that is located on the top of the boot (located to the right of the extrusion that slips over the duct). This arrow must point up when the boot is installed.



4. With the boot in one hand and with the other hand spreading the lip and groove (on the boot near the arrow), force the lip into the groove behind the lip at the top of the opening on the tub shell.

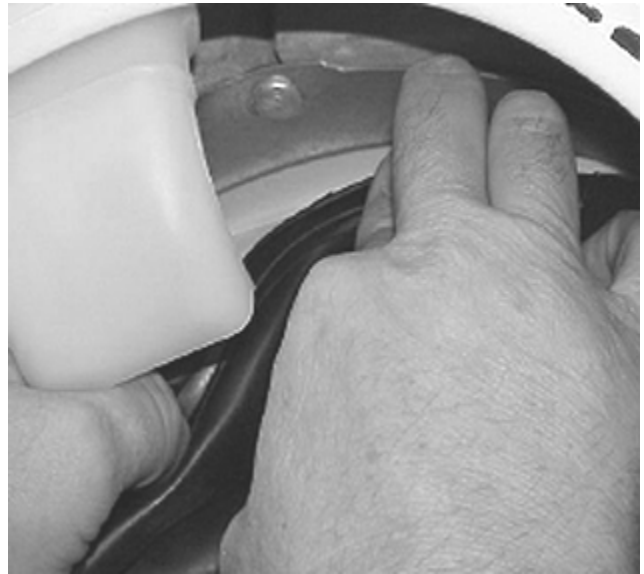

5. With one hand holding the boot so it does not slip off, use the other hand to continue spreading the lip and groove of the boot further to the right. In this way you continue this action 360 degrees around until the boot is mounted onto the front tub.



6. Installing the spring. Included in the replacement boot kit is a set of three spacers.



These spacers are to be used to hold the spring in place in the groove on the outside perimeter of the boot. As it will take both hands to stretch this spring into place, these spacers will prevent the spring from popping out when you let go of it to use both hands to stretch it further around the boot. Begin by pushing the spring down into the groove just forward from where the boot contacts the front tub shell at about the 12 o'clock position. While holding the spring in place with one hand, use the other to tightly wedge the spacer above it, between the spring (in its groove) and the weight ring above it.



7. Working to the right, push the spring down into the groove. Once the spring has been installed about 90 degrees around the opening from the first spacer, the spring will begin to get tight. Install another spacer at that point. Check the first spacer to make sure it stays in place.

8. Continue working your way around until you reach 180 degrees from the first spacer. Install the third spacer.
9. The spring will be extremely tight now.



Once you have gone more than half way around, the spring will be easier to roll into the rest of the groove. When you have the spring in place, make sure to remove the three spacers.

10. Replace the boot extrusion back onto the duct and pull it up over the ridge on the duct near the top of the opening.



Reinstall the clamp in such a way that the clamp sits between the ridges on the extrusion and above the ridge on the duct. Snap the clamp closed with the copper tubing tool.

11. Before attaching the new boot to the front panel, clean the surface of the front panel with alcohol or household cleaner. Also clean the flat surface of the new boot that will be contacting the front panel. This step is needed to remove the mold release material used in the manufacturing process and will allow the adhesive to stick.
12. Remount the boot onto the front panel making sure the boot is not wrinkled. If large wrinkles exist, this may pool water in the boot and dribble onto the floor when the door is opened. If this is the case, pull it loose from the front panel and remount it slightly more clockwise or counter clockwise as needed.



13. Using the adhesive supplied in the kit, sparingly apply dots of glue under the edge of the boot.



Spot glue at the 12 o'clock, 1, 2, 3, 4, 5, 6, 7, 8 and 9 o'clock positions around the opening.

14. Caution the consumer to wait a two hours before using the washer to allow the adhesive enough time to dry.

Removing the water inlet duct:

1. Disconnect the washer from electrical supply.
2. Remove the top panel and detergent dispenser cavity.
3. Disconnect the boot from the duct.
4. Remove the two screws holding the duct to the front panel.



5. Pull the duct to the rear and disconnect the inlet hose. NOTE: Reglue boot as needed.

Removing the detergent dispenser solenoid assembly:

1. Disconnect the washer from electrical supply.
2. Remove the top panel from the washer.
3. Unplug the wires and disconnect the hoses from the dispenser solenoid assembly.

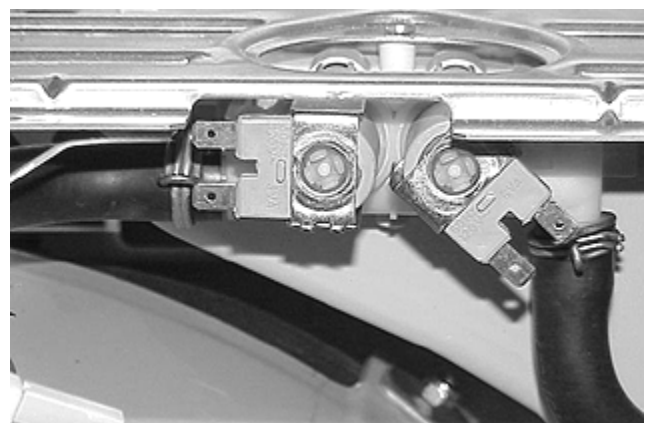

- Remove the two screws holding the solenoid assembly to the detergent dispenser cavity and pull the assembly back.

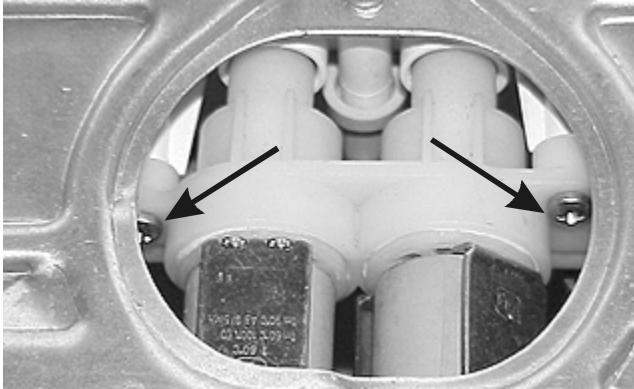

Removing the detergent cavity assembly:

- Disconnect the washer from electrical supply.
- Remove the top panel and the top panel front mounting brackets.
- Remove the control panel (front control models) or front panel (top control models).
- Disconnect the vent hose.

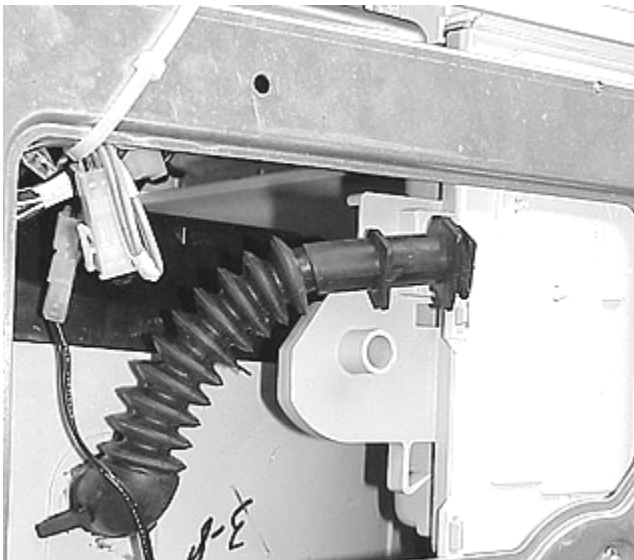

- Remove the suspension spring retainers and reinstall the rear screws without the spring retainer. This will hold the control mounting panel down when the springs are lifted. Unhook tub support springs and move them to the next large hole back on the side panel flange.

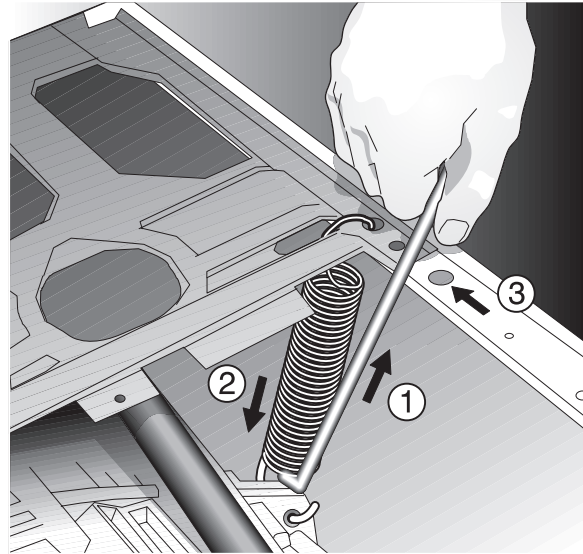

The springs may be removed by grasping the tub assembly on the lower tub reinforcement area and lifting (4:00 and 7:00 position approx.) while guiding the top end of the spring with the other hand to the new location. Or a simple tool may be bent from 1/4" round rod that will simplify this task. Use the tool to hook the bottom of the spring and lift to remove.

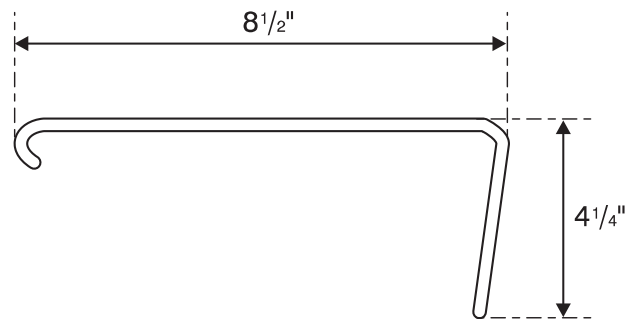

Spring Release Tool Bent From 1/4" Rod

- Remove the detergent dispenser solenoid assembly.
- Remove the one screw from dispenser assembly.

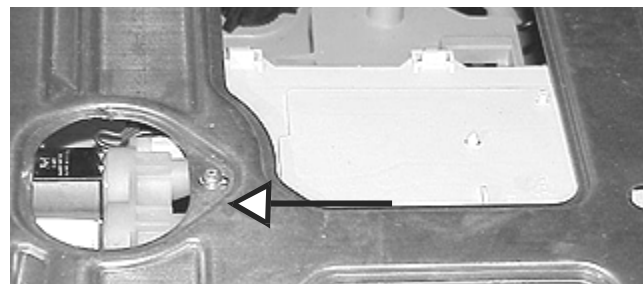

8. Push to release catches on upper front corners and the center of dispenser assembly and push dispenser rearward.

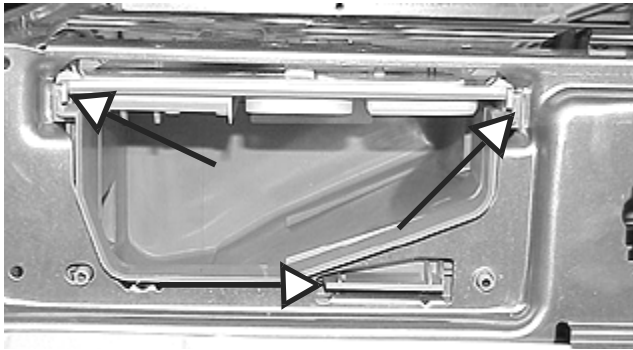

Removing the pressure switch:

1. Disconnect the washer from electrical supply.
2. Remove the top panel.
3. Disconnect the wiring and the hose from the pressure switch.
4. Remove the one screw holding pressure switch to the top brace.

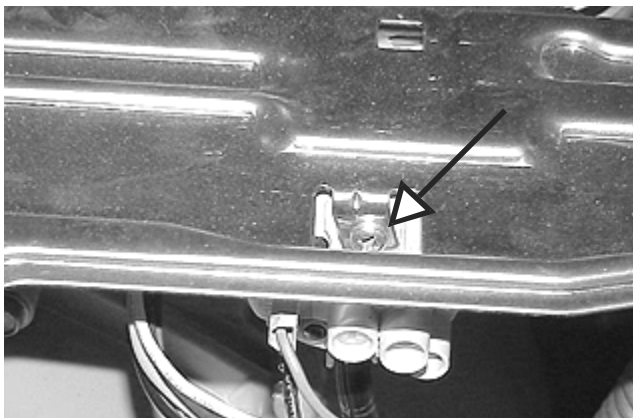

Removing the suspension springs:

1. Disconnect the washer from electrical supply.
2. Remove the top panel.
3. Remove the two screws holding the suspension spring retainers to the control mounting panel.

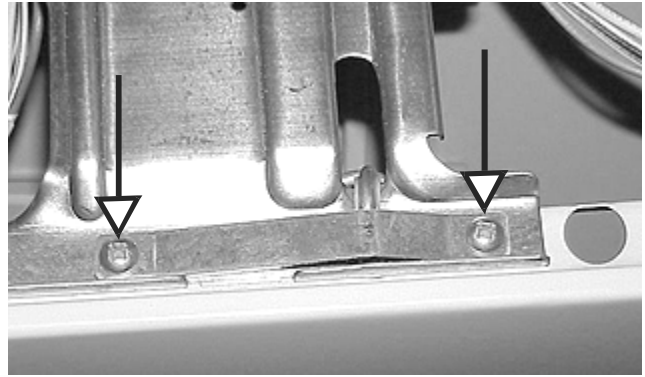

4. Reinstall the two screws to hold the mounting plate down.
5. Detach the spring from the control mounting plate by grasping the tub assembly on the lower tub reinforcement area and lifting (4:00 and 7:00 position approx.) while guiding the top end of the spring with the other hand.
6. Rotate the spring to release it from the tub.

Removing the automatic temperature control board:

1. Disconnect the washer from electrical supply.
2. Remove the top panel.
3. Remove the two screws holding the protective box from the rightside panel.

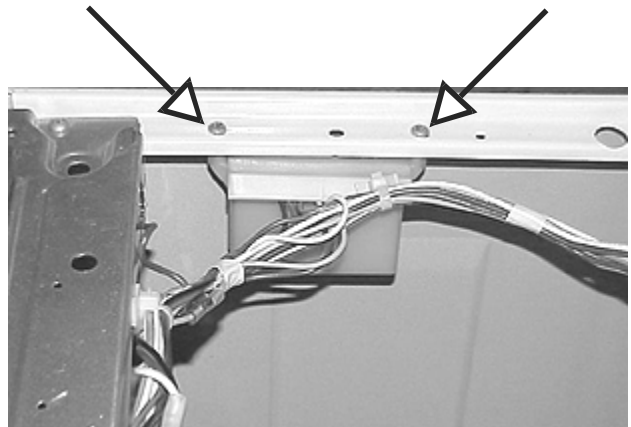

4. Lift the lid and unplug the wire harness from the board. Slide the board up and out to the protective box.

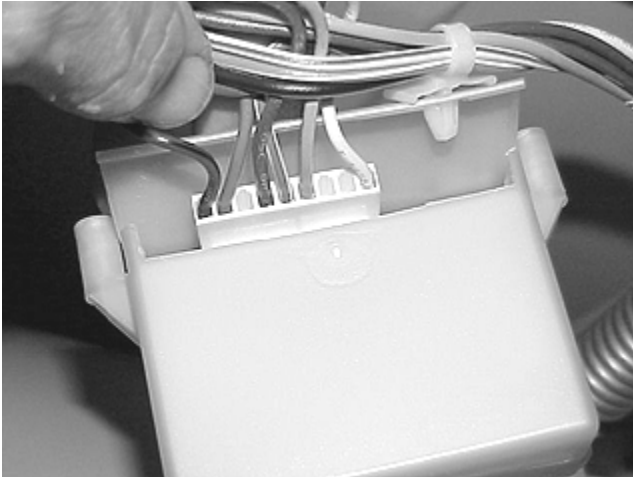

Removing the automatic temperature control sensor:

1. Disconnect the washer from electrical supply.
2. Remove the top panel.
3. Unplug the harness from the sensor and disconnect the hoses.



Removing the water inlet valve:

1. Disconnect the washer from electrical supply and turn off the water supply.
2. Remove the top panel.
3. Disconnect the two inlet hoses.
4. Unplug the wiring harness and disconnect the outlet hose.

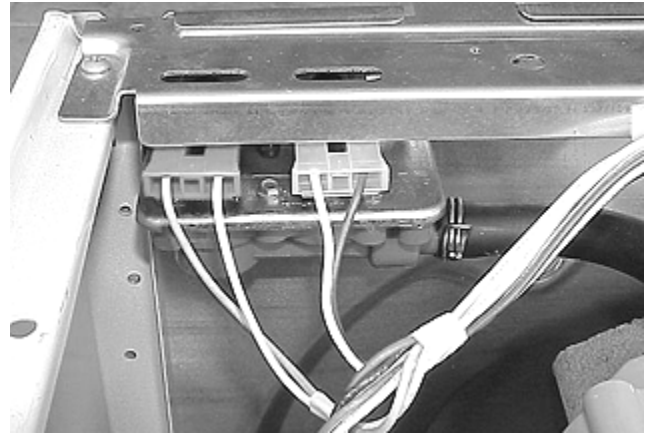

5. Remove the two screws holding the valve to the rear bar.

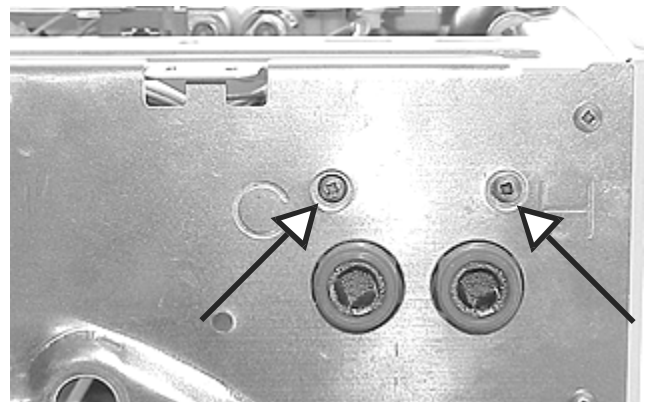

Removing the drain pump assembly:

1. Disconnect the washer from electrical supply.
2. Remove front access panel from washer.
3. Remove the one screw securing motor cover to pump.

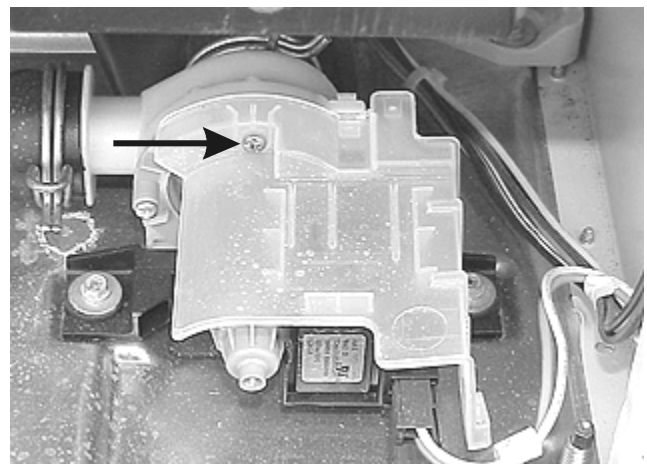

4. Disconnect electrical harness plug from pump motor.
5. Remove drain hose from drain and empty any remaining water in hose. Use a large pot or pan.
6. Disconnect the hoses from the pump.
7. Remove two 5/16" hex head screws securing the drain motor and pump assembly to cabinet base and lift the assembly out.

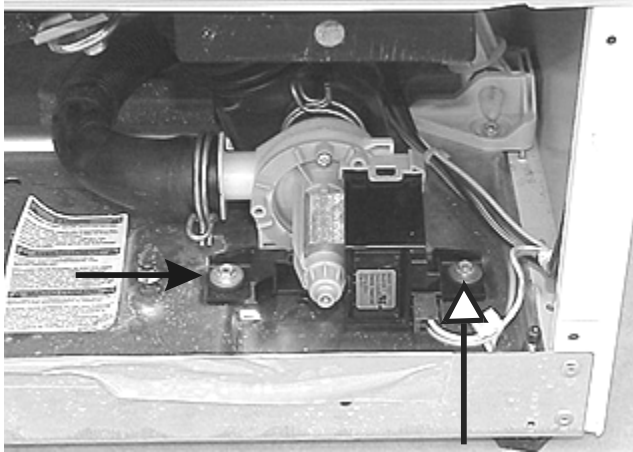

Disassembling the drain pump:

1. Disconnect the washer from electrical supply.
2. Remove the drain pump from the washer.
3. The check valve is located in the output connection of the pump. To remove the check valve lift it off its tab.

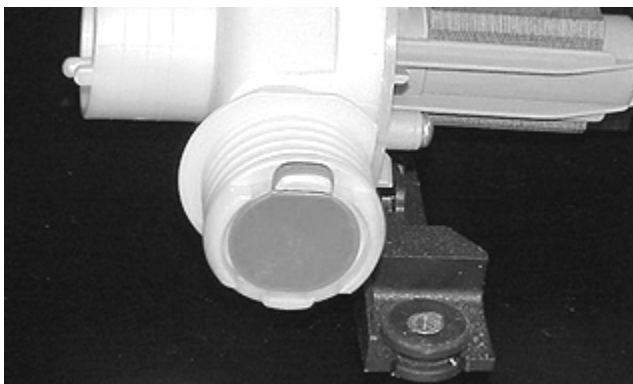

4. To remove the rear pump housing, remove three screws locking the housings together and pull the housings apart. (Do not twist.)

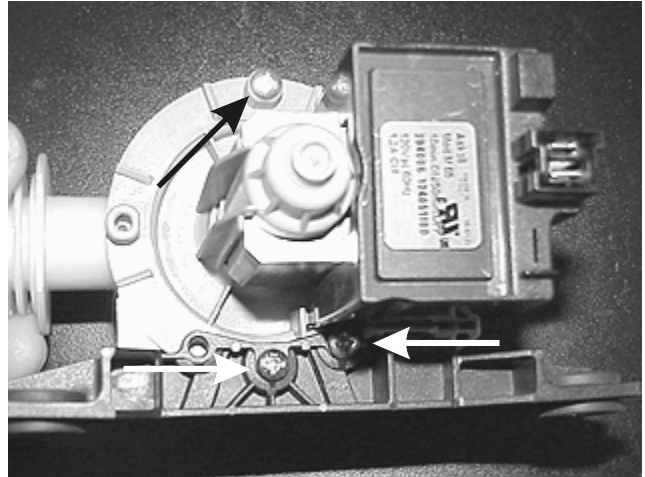

To remove the air bell:

1. Disconnect washer from electrical supply.
2. Remove the front service panel.
3. Remove drain hose from drain and empty any remaining water in hose. Use a large pot or pan.
4. Remove clamp securing air bell to sump hose and remove connecting tube from air bell.

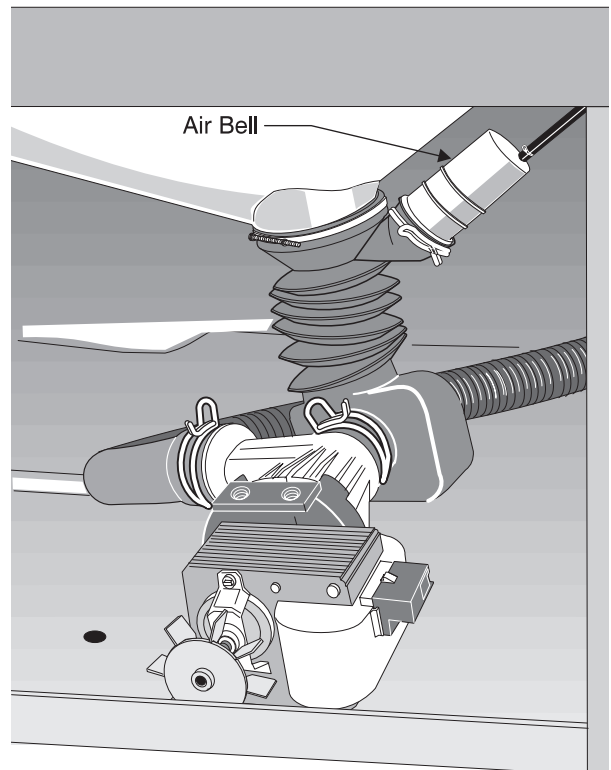

NOTE: Seal air connecting tube to air bell and air bell to sump hose using waterproof glue such as p/n 5364709100. DO NOT plug air connecting tube opening.

Removing the back service panel:

1. Disconnect the washer from electrical supply and turn off the water supply.
2. Disconnect the water inlet hoses and remove the four screws from the hinge brackets for the top.
3. Remove the sixteen screws holding the back panel to the top brace, sides and bottom.

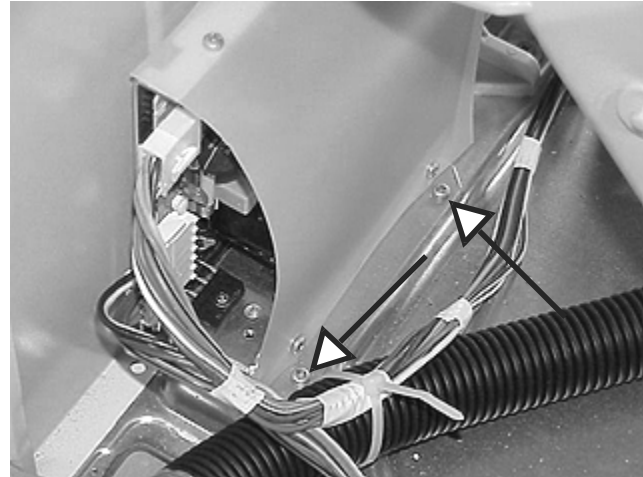

4. To remove the cover remove the four screws holding it to the frame of the assembly.

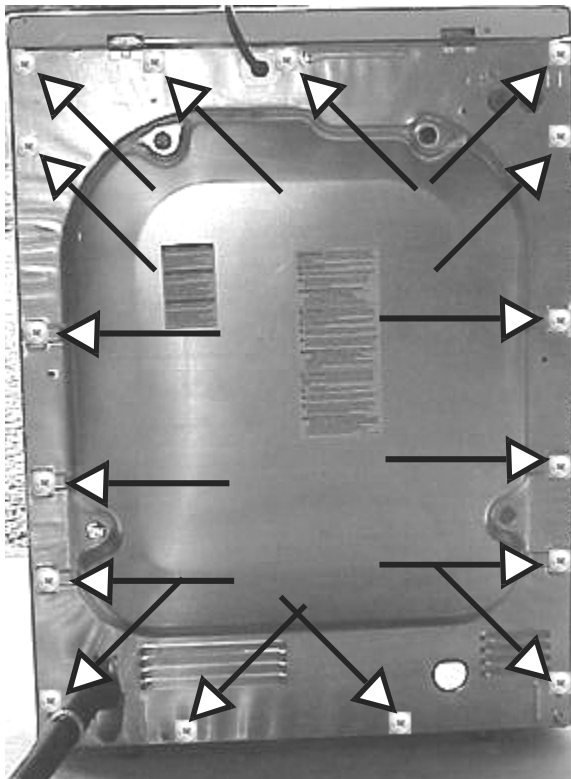

Removing the speed control board assembly:

1. Disconnect the washer from electrical supply and turn off the water supply.
2. Remove the rear service panel.
3. Unplug the two electrical plugs, remove the two screws holding the assembly to the base and pull back and up to release the tab.

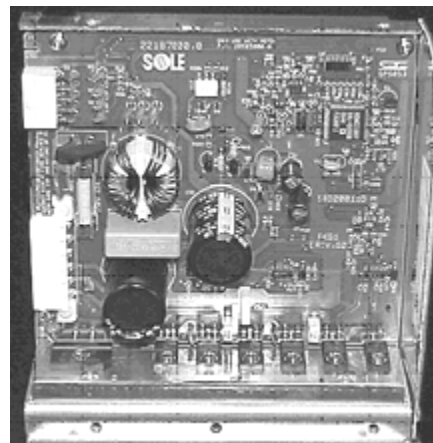

Drive belt:

The drive belt (6 rib flat Poly-V) is used to transmit power from the motor pulley to the tub. The belt is constructed of a material that stretches, which makes belt tension adjustments unnecessary.

To remove or replace the drive belt:

1. Disconnect washer from electrical supply.
2. Remove rear service panel.
3. Remove belt by turning tub drive pulley and rolling belt off pulley. The belt is elastic and is designed to "give" enough to remove and install in this manner.
4. Reverse procedure to reinstall, making sure that belt tracks in the center of the tub pulley. Adjust tracking, if required, by moving belt on motor pulley.

Removing the drive motor:

1. Disconnect washer from electrical supply.
2. Remove rear service panel.
3. Remove belt by turning tub drive pulley and rolling belt off pulley. The belt is elastic and is designed to "give" enough to remove and install in this manner.
4. Disconnect the wiring harness connector block.
5. Remove motor mounting bolts.
6. Slide motor to front while supporting to remove.
7. Reverse procedure to reinstall, making sure that belt tracks in the center of the large pulley. Adjust by moving belt on motor pulley if required.

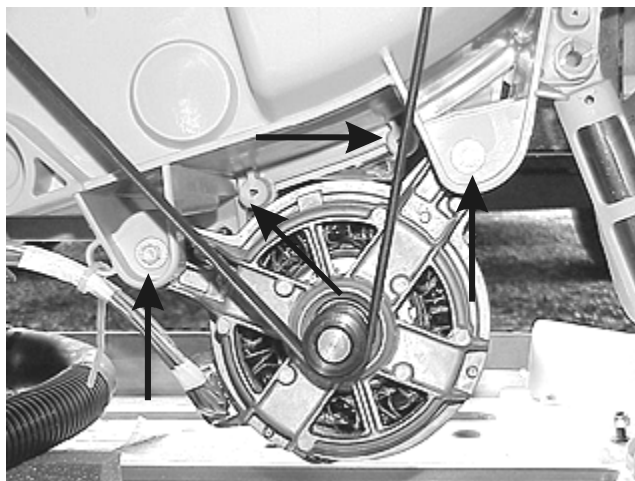

Removing the large pulley:

1. Disconnect the washer from electrical supply and turn off the water supply.
2. Remove the rear service panel and remove belt.
3. Using a 9/16" wrench Remove the bolt in the center of the pulley by holding the pulley and turning the bolt counter clockwise.

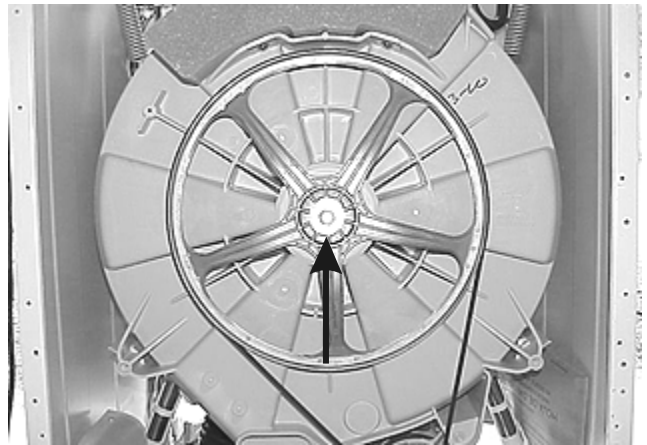

Removing the rear counter weight:

1. Disconnect the washer from electrical supply and turn off the water supply.
2. Remove the top panel and the rear service panel.
3. Using a 7/16" wrench remove the two bolts holding the weight to the back half of the outer tub.



Removing the air shock absorber:

1. Disconnect the washer from electrical supply and turn off the water supply.
2. Remove the front and the rear service panel.
3. Remove air shock securement pins by depressing

locking tab while pulling pin to remove. This procedure is much easier if a deep 1/2", 6 point socket (or 13 millimeter, 6 point) is used to compress the locking tab of the plastic pin. Push the socket onto the tapered end of the pin as far as it will go to compress the locking tab.



4. Use pliers to grasp head of pin and pull to remove. As the pin is removed the socket will drop free.
5. When replacing the air shock make sure to position it with the bell end facing downward.
6. Lubricate the securement pins with Sil-Glide® before installing.

Removing the outer tub:

1. Disconnect the washer from electrical supply.
2. If dryer is stacked on washer, remove clothes dryer from top of washer.
3. If freestanding or undercounter installation, remove the top panel.
4. Shut off water supply and disconnect water supply hoses from water valve.
5. Remove rear access panel from washer.
6. Disconnect the motor wiring harness connector block. Remove wire tie to free harness from tub.
7. Remove pressure fill tube from water level control.
8. Remove the front access panel.
9. Loosen clamp securing sump hose from tub and remove bellows style hose from tub.

10. Remove wire spring clamp from air bell.
11. Remove the two air shock upper securement pins.
12. Pull upper end of air shocks free from tub and position shocks upright away from tub for clearance.
13. Protect floor and carefully lay washer on its back.
14. Remove the vent hose
15. Pull outer lip of boot from flange on front panel and disconnect the boot from the fill tube.
16. Remove one screw of the suspension spring retaining strap and loosen the other one. Pivot strap out of the way to permit access to spring. Remove suspension springs from washer cabinet and then from outer tub.
17. Carefully lift cabinet to clear tub assembly and set aside.

Removing the spin basket and rear tub half:

1. Disconnect the washer from electrical supply.
2. Remove outer tub assembly.
3. Remove the screws (23) securing the outer tub halves together. Rotate tub assembly so that front opening is face down.
4. Remove belt by turning tub drive pulley and rolling belt off pulley. The belt is elastic and is designed to "give" enough to remove and install in this manner.
5. Remove large pulley from shaft.
6. Remove the drive motor.
7. Separate outer tub halves. **CAUTION: Use caution in handling the spin basket. The outer surface is very sharp!** The replacement rear outer tub half comes with new bearings, water seal, and tub seal between halves already installed.
8. Reverse procedure to reassemble using illustration below to show outer tub screw tightening sequence.

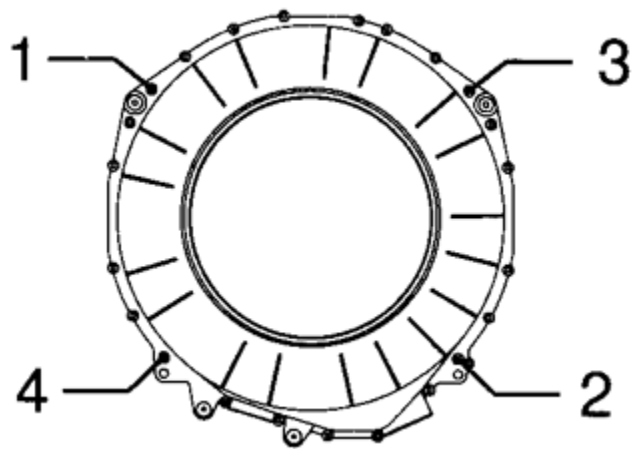

Removing the front counter weights:

1. Remove the outer tub.
2. Using a 7/16" wrench remove the bolts holding the weight to the front half of the outer tub.

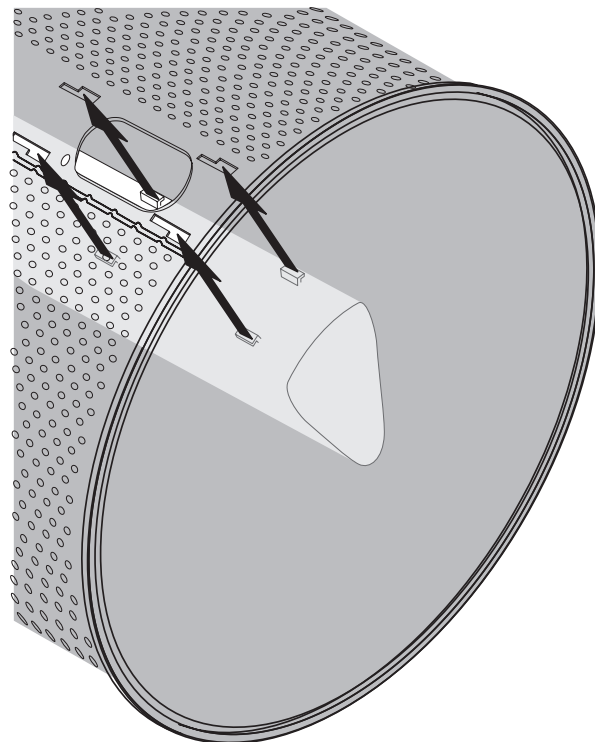

Removing the spin basket vanes:

There are three plastic vanes mounted to the spin basket to aid in the washing action during the wash cycle. Two of the vanes are secured by a screw and a tab bent into place on the basket. To remove these vanes the spin basket has to be removed. The third vane is secured only by a single screw and may be removed through the door opening.

1. Identify the vane that is located on the seam of the spin basket and remove the mounting screw.
2. Slide vane forward toward door opening until it stops.
3. Pull vane upwards to disengage tabs on vane from slots in spin basket.

4. Reverse procedure to replace. If screw hole on spin basket is stripped, drive screw into other hole on vane to secure.

