

FREESTANDING DUAL FUEL RANGE PRODUCT SERVICE MANUAL

MODELS - EW30DF65G * , CEWDF65G *

Wave-Touch™



EW30DF65

 **Electrolux**

TABLE OF CONTENTS

<p>SAFE SERVICING PRACTICES 3</p> <p>SERVICE TIPS - DEVELOP GOOD WORK HABITS 4</p> <p>SERVICE TOOLS AND EQUIPMENT 4</p> <p>RANGE TECHNICAL DATA 5</p> <p style="padding-left: 20px;">Maximum Allowable Surface Temperatures 5</p> <p style="padding-left: 20px;">RTD Temperature / Resistance Chart 5</p> <p style="padding-left: 20px;">Dual Fuel Range</p> <p style="padding-left: 20px;">Component Resistance Chart 5</p> <p style="padding-left: 20px;">Oven Relay Board Circuit Analysis Matrix (ES 610/615) 6</p> <p style="padding-left: 20px;">EOC Signal Voltage Test Matrix 6</p> <p style="padding-left: 20px;">Variable Speed Control Board 7</p> <p style="padding-left: 20px;">Power Supply Board 7</p> <p style="padding-left: 20px;">Terms and Abbreviations 7</p> <p style="padding-left: 20px;">Electronic Oven Control</p> <p style="padding-left: 20px;">Failure/Fault Codes (ES630) 8</p> <p style="padding-left: 20px;">Schematic Diagram 9</p> <p style="padding-left: 20px;">Wiring Diagram 10</p> <p>PRODUCT OVERVIEW 11</p> <p>LP GAS CONVERSION 11</p> <p>TOUCH SENSOR TECHNOLOGY (TST) CONTROL SYSTEM 12</p> <p style="padding-left: 20px;">Troubleshooting The TST Panel 12</p> <p style="padding-left: 20px;">Diagnostic Service Mode 13</p> <p>ELECTRONIC OVEN CONTROL (ES630) 14</p> <p style="padding-left: 20px;">EOC Troubleshooting and Testing 15</p> <p style="padding-left: 20px;">Power Supply Board 15</p> <p style="padding-left: 20px;">Oven Relay Board 16</p> <p>VARIABLE SPEED CONTROL 17</p> <p style="padding-left: 20px;">Variable Fan Speed 17</p> <p style="padding-left: 20px;">LUXURY™ Lighting 18</p> <p>RACK SENSING SWITCH 19</p> <p>MEAT PROBE FEATURE 21</p> <p style="padding-left: 20px;">Theory Of Operation 21</p> <p style="padding-left: 20px;">Component Parts 21</p> <p style="padding-left: 20px;">Troubleshooting 21</p>	<p>COMPONENT ACCESS AND REPLACEMENT</p> <p>OVEN DOOR 22</p> <p style="padding-left: 20px;">Door Removal 22</p> <p style="padding-left: 20px;">Door Disassembly 23</p> <p>COOKTOP REMOVAL</p> <p style="padding-left: 20px;">Cooktop Removal - Dual Fuel Range 27</p> <p style="padding-left: 20px;">Orifice Holders 29</p> <p style="padding-left: 20px;">Removing Manifold Panel 29</p> <p style="padding-left: 20px;">Replacing Ignitor Switches and Harness 30</p> <p style="padding-left: 20px;">Replacing Surface Burner Valves 30</p> <p>UPPER OVEN COMPONENTS 31</p> <p style="padding-left: 20px;">Luxury Glide Oven Rack</p> <p style="padding-left: 20px;">Removal & Maintenance 31</p> <p style="padding-left: 20px;">Rack Sensor Assembly</p> <p style="padding-left: 20px;">Removal & Maintenance 32</p> <p style="padding-left: 20px;">Bake Element 33</p> <p style="padding-left: 20px;">Broil Element 34</p> <p style="padding-left: 20px;">Convection Fan Blade and</p> <p style="padding-left: 20px;">Element Replacement 35</p> <p style="padding-left: 20px;">Rack Sensing Switch Replacement 35</p> <p style="padding-left: 20px;">Halogen Oven Lights 36</p> <p>LOWER OVEN COMPONENTS -</p> <p style="padding-left: 20px;">Dual Fuel models 37</p> <p style="padding-left: 20px;">Replacing Lower Oven Element 37</p> <p style="padding-left: 20px;">Replacing Lower Oven Temperature Probe 38</p> <p style="padding-left: 20px;">Replacing Lower Oven Thermal Cutout 39</p> <p style="padding-left: 20px;">Replacing Drawer Glide Rails 39</p> <p style="padding-left: 20px;">Replacing Drawer Seal 40</p> <p style="padding-left: 20px;">Lower Oven Chassis 40</p>
---	---

MODEL APPLICATION LIST

The information contained in this manual can be applied to the models listed below:

EW30DF65GB EW3L65DFGW CEW30DF6GB
 EW30DF65GS EW3L65DFGB CEW30DF6GB
 EW30DF65GW EW3L65DFGS CEW30DF6GB

LP GAS CONVERSION INFORMATION

Electrolux branded Dual Fuel ranges are not approved for LP conversion. LP versions of these ranges are available by the following model numbers:

EW3LDF65GB, EW3LDF65GS, EW3LDF65GW

NOTE:

The information contained in this manual is subject to change as product development continues after the date this manual was created.

SAFE SERVICING PRACTICES

- ALL APPLIANCES -

To avoid personal injury and/or property damage, it is important that Safe Servicing Practices be observed. The following are some limited examples of safe practices:

1. DO NOT attempt a product repair if you have any doubts as to your ability to complete it in a safe and satisfactory manner.
2. Before servicing or moving an appliance:
 - Remove the power cord from the electrical outlet, trip the circuit breaker to the OFF position, or remove the fuse.
 - Turn off the gas supply.
 - Turn off the water supply.
3. Never interfere with the proper operation of any safety device.
4. USE ONLY REPLACEMENT PARTS CATALOGED FOR THIS APPLIANCE. SUBSTITUTIONS MAY DEFEAT COMPLIANCE WITH SAFETY STANDARDS SET FOR HOME APPLIANCES.
5. GROUNDING: The standard color coding for safety ground wires is GREEN, or GREEN with YELLOW STRIPES. Ground leads are not to be used as current carrying conductors. It is EXTREMELY important that the service technician reestablish all safety grounds prior to completion of service. Failure to do so will create a hazard.
6. Prior to returning the product to service, ensure that:
 - All electrical connections are correct and secure
 - All electrical leads are properly dressed and secured away from sharp edges, high-temperature components, and moving parts
 - All non-insulated electrical terminals, connectors, heaters, etc. are adequately spaced away from all metal parts and panels
 - All safety grounds (both internal and external) are correctly and securely connected
 - All panels are properly and securely reassembled
 - All gas connections are secure and have been leak tested

ATTENTION!!!

This service manual is intended for use by persons having electrical and mechanical training and a level of knowledge of these subjects generally considered acceptable in the appliance repair trade. The manufacturer cannot be responsible, nor assume any liability, for injury or damage of any kind arising from the use of this manual.

SERVICE TIPS - DEVELOP GOOD WORK HABITS

Consistently following a standard routine when servicing appliances will insure that you do not waste time searching for a complex solution to a simple problem. One of the most common mistakes made by service technicians is failing to verify the incoming power supply to the appliance.

Many times electronic controls and other components are replaced unnecessarily because the incoming power supply was not verified. When testing the electrical supply the test should be performed at the terminal block where the power cord or house wiring attaches to the appliance. Verify that there are 240 volts between L1 & L2 and that there is 120 volts from L1 to Neutral and also from L2 to Neutral. You should also check the power supply while the appliance is operating or “under load”. The power supply may check good with the product sitting idle but fail when certain components are turned on. This can be caused by a weak connection in the customer’s house wiring, or a faulty circuit breaker or fuse.

Another common mistake is failure to verify all component part wire harness connections. It is essential that all component connections be checked visually and with the appropriate circuit tester. Many times components are assumed to be faulty because they do not operate or there is an error code displayed by the electronic control system. Often the failure is caused by a loose or miswired connection which can cause the same error code as a defective component part. Newly installed appliances may have loose connections resulting from shipping and handling conditions or improper installation. Check the wiring connections before you order replacement parts.

When the repair has been completed the product should be thoroughly tested to verify that the service performed corrected the problem and that all of the other features and functions of the product are in proper working order. The extra time taken to do this will create consumer confidence in your efficiency and professionalism as well as possibly saving an expensive callback.

SERVICE TOOLS AND EQUIPMENT

In addition to standard hand tools such as wrenches, screwdrivers, pliers, etc; the following instruments are considered to be essential equipment for technicians servicing Electrolux cooking products. Proper testing and diagnostic procedures are not possible without these tools.

- Volt/ohmmeter - Must be capable of voltage measurement from 0 to 500 volts AC and resistance measurements from 0 to 2 meg-ohms. This usually requires a meter that utilizes a 9 volt battery. Either digital or analog meters are acceptable however most technicians find analog meters easier to use. Appropriate test leads and tips are required to test certain electronic components and connections.
- Clamp on amp meter - Should be capable of measuring from 0 to 60 amps.
- Temperature Meter - Should be high quality with thermocouple or electronic “K-type” test probe. Capable of temperature readings up to 1000 degrees Fahrenheit.

Additional instruments that a technician will need to have access to at various times include the following:

- Combustible gas leak detection meter.
- U tube manometer or equivalent testing device for measuring LP and Natural gas line pressure on gas ranges. Measurements must be in IWC (inches water column)
- Carbon Monoxide (CO) detection meter capable of measuring from 0-1000 PPM.
- Microwave Leak Detection Meter

NOTE: Electrolux Does Not Supply Tools Or Test Instruments.

RANGE TECHNICAL DATA

MAXIMUM ALLOWABLE SURFACE TEMPERATURES

All gas and electric ranges must comply with U.L and A.N.S.I. surface temperature limits outlined in the following chart. Note that the testing temperature is different for electric ranges produced *after* 08/26/2003.

SURFACE TEMPERATURE LIMITS	MATERIAL TYPE / FINISH				
	PAINTED	PORCELAIN	GLASS	PLASTIC†	METAL
1. Product must be undamaged, correctly assembled and have the correct oven temperature.					
2. All skin temperatures are based on a room temperature of 77° F (25° C) and an oven set temperature as specified below: For ELECTRIC ranges built prior to 08/26/2003 - 400° F For ELECTRIC ranges built after 08/26/2003 - 475° F For GAS ranges built prior to 01/01/2004 - 400° F For GAS ranges built after 01/01/2004 - 475° F					
3. Oven must be cycling at designated test temperature for one hour before test is conducted.					
4. Pyrometers, (temperature testers), must be of high quality and properly adjusted.					
5. An increase or decrease of 1° F in the room ambient temperature, will allow a 1° F increase or decrease in the maximum allowable surface temperature of the range.					
	LOCATION				
	Side Panel	152° F	160° F	—	—
	Oven Door	152° F	160° F	172° F	182° F
	Warmer Drawer Front Panel	152° F	160° F	—	—
	Knobs & Handles	—	—	—	*167° F **182° F
	Skirt	—	—	—	*182° F *152° F
	Cooktop Lower Console Oven Vent Area	NO TEMPERATURE LIMITS APPLY TO THIS AREA			
† Includes plastic with metal plating not more than 0.005" thick and metal with a plastic covering not less than 0.005" thick.					
* Self-Clean Gas Range at Clean Temperature ** Self-Clean Electric Range at Clean Temperature					

RTD TEMPERATURE / RESISTANCE CHART

The chart seen here can be used to test the resistance of the oven temperature sensor probe. For accuracy in testing use a high quality thermometer or temperature meter to determine actual oven temperature before reading the resistance of the probe.

RTD SCALE	
TEMPERATURE °F	RESISTANCE Ω
32 ± 1.9	1000 ± 4.0
75 ± 2.5	1091 ± 5.3
250 ± 4.4	1453 ± 8.9
350 ± 5.4	1654 ± 10.8
450 ± 6.9	1852 ± 13.5
550 ± 8.2	2047 ± 15.8
650 ± 13.6	2237 ± 18.5
900 ± 13.6	2697 ± 24.4

Dual Fuel Range Component Resistance Chart

NOTE: RESISTANCE MEASUREMENTS ARE APPROXIMATE. VARIATIONS DUE TO TEMPERATURE CHANGES AND OTHER FACTORS ARE NORMAL.

COMPONENT	VOLTAGE RATING	WATTAGE	APPROXIMATE RESISTANCE Ω (OHMS)
BAKE ELEMENT	208 / 242	3000	16 Ω
BROIL ELEMENT	208 / 242	4000	14 Ω
WARMER DRAWER ELEMENT	108 / 132	700	20.5 Ω
WARMER DRAWER ELEMENT	108 / 132	450	32 Ω
MINI OVEN ELEMENT	108 / 132	1000	14 Ω
CONVECTION ELEMENT	108 / 132	350	40 Ω
CONVECTION ELEMENT	108 / 132	200	72 Ω
CONVECTION FAN MOTOR WINDINGS	108 / 132		35 Ω
LOCK MOTOR WINDINGS	108 / 132		2000 Ω
OVEN TEMPERATURE SENSOR PROBE (AT ROOM TEMPERATURE)	-		1100 Ω * *(REFER TO RTD CHART)

RANGE TECHNICAL DATA

ES 610/615 Oven Relay Board Circuit Analysis Matrix - Dual Fuel Range

Relay Contacts		P4 (R) to P2 (O)	P6 (BK) to P10 (Y)	P6 (BK) to P8 (BL)	P6 (BK) to P12 (Y/BK)	J4/3 (BK) to J4/5 (V)	J4/3 (BK) to J4/6 (BR)
Component		L2 Out Relay	Bake Element	Broil Element	Lower Oven Element	Convection Element	Door Lock Motor
O P E R A T I O N	Bake / Time Bake	X	X			P	
	Convection Bake/Roast	X	X			X	
	Broil			X			
	Dehydrate	X	X			X	
	Bread Proof					X	
	Slow Cook	X	X				
	Keep Warm (Upper Oven)	X	X				
	Keep Warm (Lower Oven)				X		
	Bake (Lower Oven) *				X		
	Door Lock Motor Locking/Unlocking						X
	Clean	X	X				

X = Contact Closed P = Contact closed during Pre-Heat only
*Some Models

EOC Signal Voltage Test Matrix - Dual Fuel Range

Test for 3.3 VDC (+/- .5 volts) between GND on EOC circuit board and the indicated connector pin when the specified function is activated.

FREESTANDING ELECTRIC and DUAL FUEL MODELS

FUNCTION / RELAY	EOC CONNECTOR / PIN#	RELAY BOARD CONNECTOR / PIN #
Lower Oven or Warmer Drawer / K3	P9 / Pin 7	J5 / Pin 7
L2 Out / K2	P11 / Pin 4	J7 / Pin4
Broil / K4	P11 / Pin 1	J7 / Pin 1
Bake / K6	P11 / Pin 2	J7 / Pin 2
Convection Element / K10	P11 / Pin 5	J7 / Pin 5
Lock Motor / K12	P11 / Pin 6	J7 / Pin 6

RANGE TECHNICAL DATA

Variable Speed Control Board

VSC Test Points.
 Connector P6 pins 1 & 6 - 5 vdc
 Connector P2 Pins 3 & 5 - 120 vac

RELAY CONTACTS	
P2/5 (BK) to P2/1 (Tan)	P2/5 (BK) to P2/7 (Pink)

OPERATION	Oven Lamps	X	X
	Convection Fan Mtr.	X	X

X = Contact Closed

NOTE: All voltages are approximate.

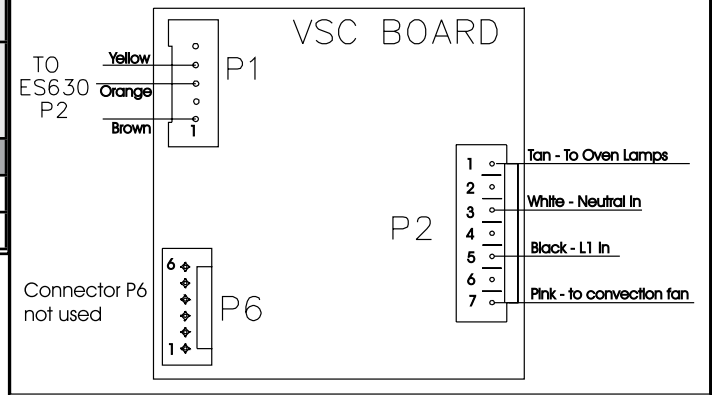

Power Supply Board

Power Supply Board (PS1 or PS2) Test Points
 Connector P1 pins 1 & 4 - 120 vac
 Connector P2 pins 1 & 5 - 8 vdc

NOTE: All voltages are approximate.

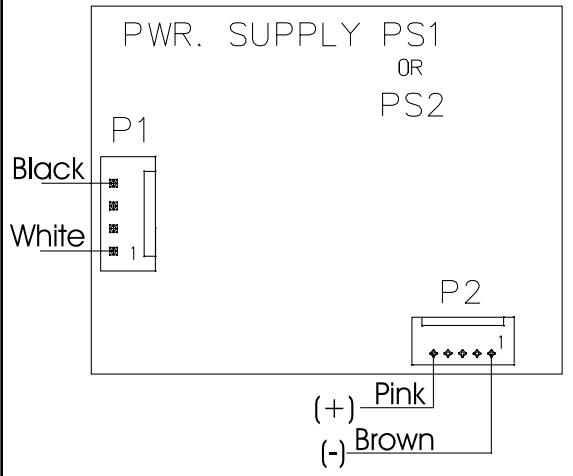

Terms and Abbreviations Used In This Manual

TECHNICAL TERMS

- BTU = BRITISH THERMAL UNIT
- EOC = ELECTRONIC OVEN CONTROL
- GND = GROUND
- LED = LIGHT EMITTING DIODE
- RTD = RESISTANCE TEMPERATURE DEVICE (Temperature Sensor Probe)
- VSC = VARIABLE SPEED CONTROL
- IWC = INCHES WATER COLUMN (Unit of measure for testing gas line pressure)
- TST = TOUCH SENSOR TECHNOLOGY (Refers to glass touch control panel)

SALES/MARKETING TERMS

- Perfect Pair™ = Lower oven in the drawer below the main oven. Also called a Mini Oven.
- IQ Touch™ = Control panel display style found on “B” model ranges.
- Wave-Touch™ = Control panel display style found on “A” model ranges.

RANGE TECHNICAL DATA

ELECTRONIC OVEN CONTROL FAILURE/FAULT CODES (ES630)

For each Fault code there is a listing of the likely failure condition or cause, as well as suggested corrective actions to be taken. Perform the steps one at a time in the order listed below to correct the specific failure condition.

Note: Fault codes are not a foolproof system. Never assume that a part has failed based on a displayed fault code. An example would be if the EOC is displaying F30 (open sensor), the failure could be caused by a loose connection or faulty wire harness between the EOC and sensor or the sensor could simply be unplugged.

FAULT CODE	LIKELY FAILURE CONDITION/CAUSE	SUGGESTED CORRECTIVE ACTION
F10	Runaway Temperature. Oven heats when no cook cycle is programmed.	<ol style="list-style-type: none"> 1. Check RTD Sensor Probe using the RTD scale found in the tech sheet. Replace if defective. 2. If oven is overheating disconnect power from the range and unplug connector P1 from power supply board 1. Reapply power to the range. If oven continues to heat when the power is reapplied, replace the oven relay board. 3. Replace the EOC <p>NOTE: Severe overheating may require the entire oven to be replaced should damage be extensive.</p>
F11	Shorted Keypad	<ol style="list-style-type: none"> 1. Reset power supply to range to see if failure code will clear. 2. Test ribbon harness and connectors between the TST panel and EOC. Replace if defective 3. Replace the TST panel 4. Replace the EOC
F13	Internal software error in EOC	Disconnect power, wait 30 seconds and reapply power. If fault returns upon power-up, replace EOC.
F14	TST Display tail missing or not connected	<ol style="list-style-type: none"> 1. Check/reattach ribbon harness and connections between TST panel and EOC. 2. Replace the TST panel 3. Replace the EOC
F15	Signal loss between oven relay board and EOC	<ol style="list-style-type: none"> 1. Test the harness and connections from EOC connector P16 to oven relay board J2. 2. Replace the oven relay board 3. Replace the EOC
F20 Electric Models Only	Communication failure between EOC and ESEC	<ol style="list-style-type: none"> 1. Test wiring harness and connections between EOC connector P2 and ESEC 30 UIB P9 2. Test wiring harness and connections between ESEC 30 UIB and ESEC 20 relay board 3. Test wiring harness and connections between PS board 2 (P2) and ESEC 30 UIB connector P7 4. Test for approximately 8 volts DC output from PS board 2 at ESEC 30 UIB connector P7, pins 1 & 5. If output voltage is incorrect test incoming power supply to PS board 2 at harness connector P1 pins 1 & 4. If incoming power is correct (120 VAC) replace PS board 2. If output voltage is correct replace ESEC 30 UIB 5. Replace EOC
F23 F25	Communication failure between VSC board and EOC	<ol style="list-style-type: none"> 1. Check harness and connections between VSC board and EOC. 2. Test for approximately 5 volts DC to VSC board at P6 connector pins 1 & 6. If voltage is correct replace VSC board. If voltage is incorrect replace EOC.
F30	Open probe connection.	<ol style="list-style-type: none"> 1. (F30 or F31) Check resistance at room temperature & compare to RTD Sensor resistance chart. If resistance does not match the RTD chart replace RTD Sensor Probe. Check Sensor wiring harness between EOC & Sensor Probe connector. 2. (F30 or F31) Check resistance at room temperature, if less than 500 ohms, replace RTD Sensor Probe. Check for shorted Sensor Probe harness between EOC & Probe connector.
F31	Shorted Probe connection	<ol style="list-style-type: none"> 1. (F30 or F31) Check resistance at room temperature, if less than 500 ohms, replace RTD Sensor Probe. Check for shorted Sensor Probe harness between EOC & Probe connector.
F90	Door lock motor latch failure	<p>If lock motor runs:</p> <ol style="list-style-type: none"> 1. Test continuity of wiring between EOC and lock switch on lock motor assy. Repair if needed. 2. Advance motor until cam depresses the plunger on lock motor switch. Test continuity of switch contacts. If switch is open replace lock motor assy. 3. If motor runs and switch contacts and wiring harness test good, replace the EOC <p>If lock motor does not run:</p> <ol style="list-style-type: none"> 1. Test continuity of lock motor windings. Replace lock motor assy if windings are open. 2. Test lock motor operation by using a test cord to apply voltage. If motor does not operate replace lock motor assy. 3. If motor runs with test cord check continuity of wire harness to lock motor terminals. If harness is good replace the EOC.

Schematic Diagram - Dual Fuel Wave Touch Models with Lower Oven

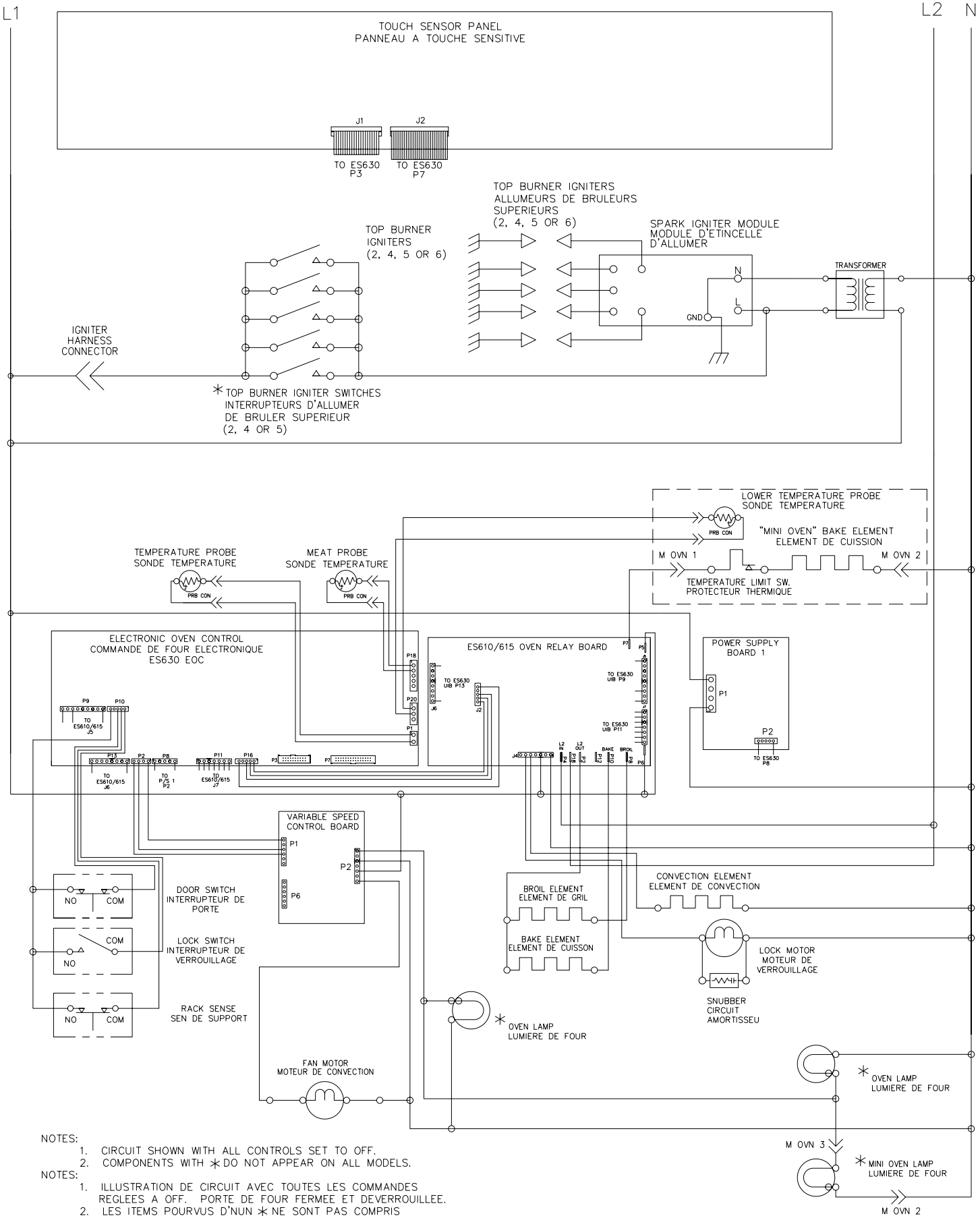

- NOTES:
1. CIRCUIT SHOWN WITH ALL CONTROLS SET TO OFF.
 2. COMPONENTS WITH * DO NOT APPEAR ON ALL MODELS.

- NOTES:
1. ILLUSTRATION DE CIRCUIT AVEC TOUTES LES COMMANDES REGLEES A OFF. PORTE DE FOUR FERMEE ET DEVERROUILLEE.
 2. LES ITEMS POURVUS D'UN * NE SONT PAS COMPRIS DANS TOUS LES MODELES.

316519948

Wiring Diagram - Dual Fuel Wave Touch Models with Lower Oven

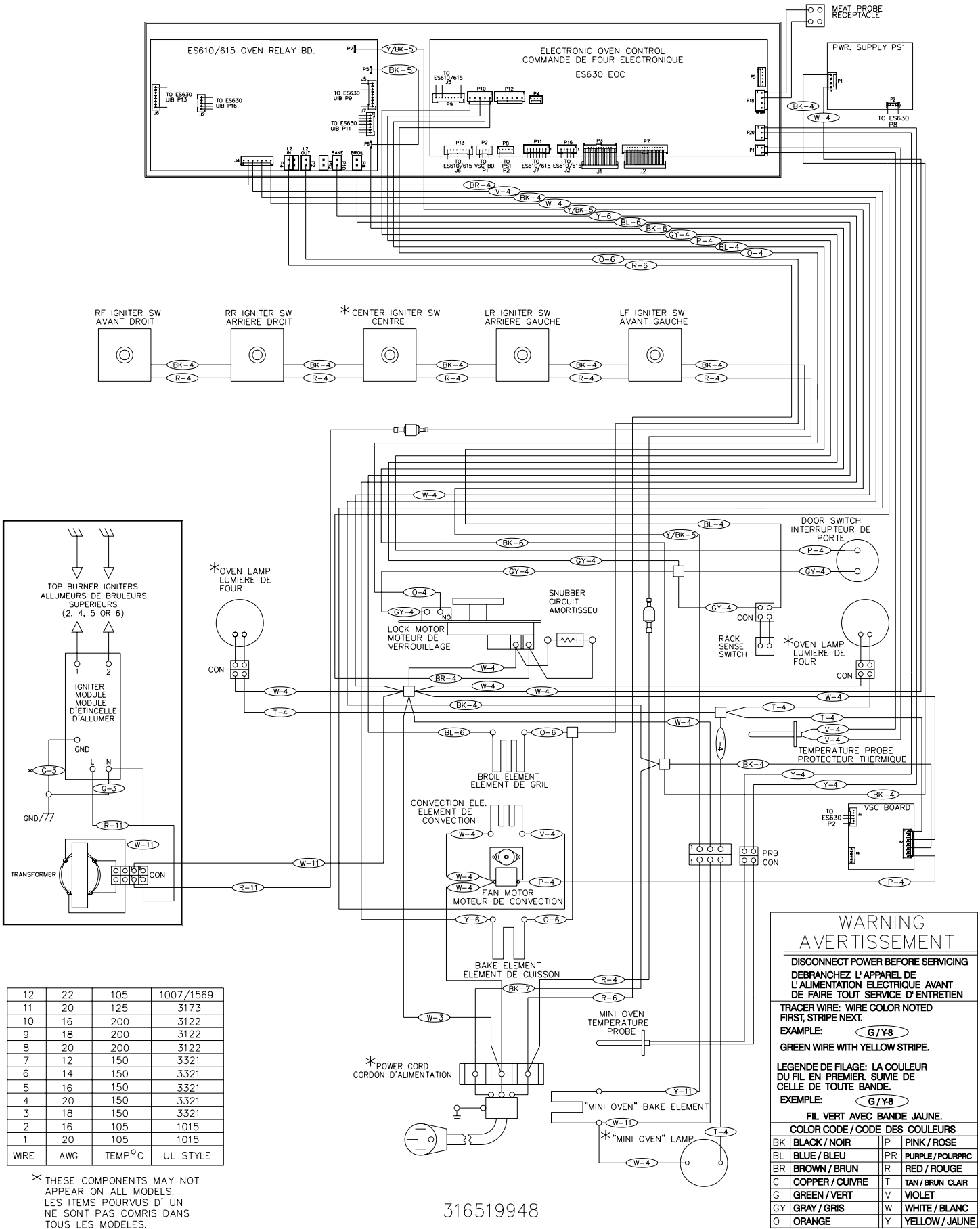

WIRE	AWG	TEMP °C	UL STYLE
12	22	105	1007/1569
11	20	125	3173
10	16	200	3122
9	18	200	3122
8	20	200	3122
7	12	150	3321
6	14	150	3321
5	16	150	3321
4	20	150	3321
3	18	150	3321
2	16	105	1015
1	20	105	1015

* THESE COMPONENTS MAY NOT APPEAR ON ALL MODELS.
LES ITEMS POURVUS D' UN NE SONT PAS COMRIS DANS TOUS LES MODELES.

**WARNING
AVERTISSEMENT**

DISCONNECT POWER BEFORE SERVICING
DEBRANCHEZ L' APPAREL DE L' ALIMENTATION ELECTRIQUE AVANT DE FAIRE TOUT SERVICE D' ENTRETIEN

TRACER WIRE: WIRE COLOR NOTED FIRST, STRIPE NEXT.
EXAMPLE: G/Y8
GREEN WIRE WITH YELLOW STRIPE.

LEGENDE DE FILAGE: LA COULEUR DU FIL EN PREMIER, SUIVE DE CELLE DE TOUTE BANDE.
EXAMPLE: G/Y8
FIL VERT AVEC BANDE JAUNE.

COLOR CODE / CODE DES COULEURS			
BK	BLACK / NOIR	P	PINK / ROSE
BL	BLUE / BLEU	PR	PURPLE / POURPRIC
BR	BROWN / BRUN	R	RED / ROUGE
C	COPPER / CUIVRE	T	TAN / BRUN CLAIR
G	GREEN / VERT	V	VIOLET
GY	GRAY / GRIS	W	WHITE / BLANC
O	ORANGE	Y	YELLOW / JAUNE

316519948

PRODUCT OVERVIEW

Electrolux branded freestanding Dual Fuel ranges are currently available with the Wave Touch control panel.

The dual fuel models feature a five burner gas cooktop with full width burner grates, a self cleaning electric main oven, convection and normal bake modes in the main oven, variable speed convection fan motor, Luxury Glide oven racks, Dual halogen oven lights, and a meat probe.

Dual Fuel models also feature a Perfect Pair™ lower oven capable of baking at temperatures up to 450 degrees in addition to functioning as a warming drawer.

The oven and warmer drawer functions are controlled by the ES630 Electronic Oven Control.

The oven door hinges are designed to allow the door to stand open in virtually any position without springing closed.

Current finish options available are White , Black and Stainless Steel. All models operate on 240 volt 60 hz AC power supply.

Wave-Touch™



EW30DF65

LP GAS CONVERSION

Dual Fuel models are not approved for LP gas conversion.

LP gas ready versions of the Dual Fuel models with lower oven are available by the following model numbers: EW3LDF65GW, EW3LDF65GB, EW3LDF65GS

TOUCH SENSOR TECHNOLOGY (TST) CONTROL SYSTEM

The TST system utilizes a touch sensitive glass panel (photo A) to allow the user to control all oven and warmer drawer operations. The TST panel is connected to the electronic oven control (EOC) via ribbon connectors. It is similar in function to a membrane switch.

The TST control panel generates an electromagnetic field around each touch pad. When this field is interrupted by touching the glass, the control panel communicates the selection information to the EOC. The EOC then responds by signaling the oven relay board to close the appropriate relays to perform the selected operation or function.

NOTE: The TST system touch glass is a non serviceable part and must be replaced as a complete assembly if found to be defective. The replacement glass panel will come attached to the frame and will include ribbon connectors. (Photo B)

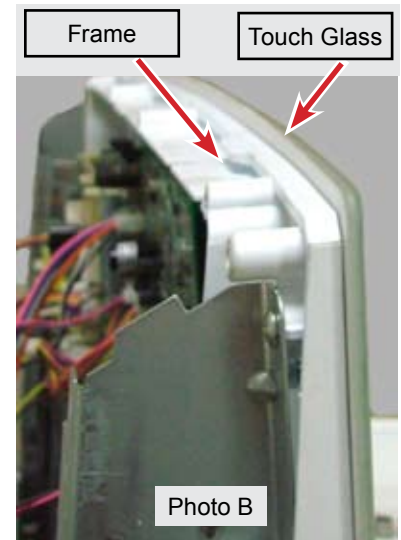

Troubleshooting The TST Panel

The TST control panel has ribbon connectors that link it to the EOC. (Photo C).

If these connectors fail or become loose the TST control panel will not operate and under some conditions will generate a fault code in the EOC display window.

If the TST control malfunctions or fails to operate inspect and re-seat the ribbon connectors. If a failure/fault code is present follow the diagnostic procedure for that code.

If no fault code appears but the EOC does not respond when the TST panel is touched then the cause is either a defective EOC or TST panel. Replace the EOC first. If the problem remains replace the TST panel assembly.

If only a single key is non responsive then the TST panel is the most likely cause of failure.

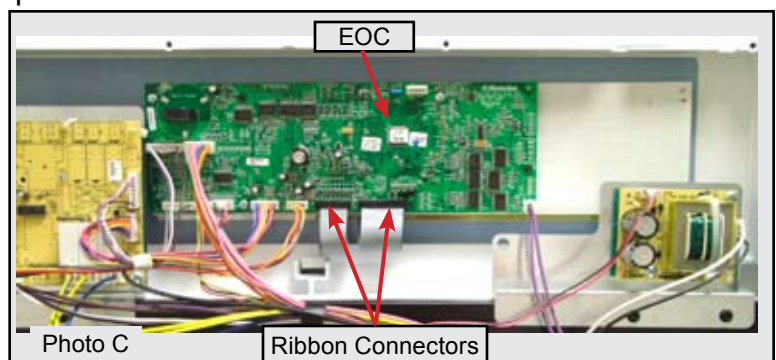

Diagnostic Service Mode

When an error or failure occurs in the Electronic Oven Control (EOC) system the control panel will usually produce an audible beep accompanied by a special display to indicate that there is a failure condition. In order for a service technician to be able to more easily determine which failure condition has occurred a special Diagnostic Service Mode has been built in to the control panel software.

To enter the service mode the range must be in the "IDLE" condition meaning that all elements and functions are turned off. Press and hold the TIMER keypad for the upper oven and the Upper Oven selector keypad for 3 seconds. Always press the TIMER keypad first immediately followed by the Upper Oven selector keypad. After three seconds the control panel will enter the service mode and will display the most recent error or failure codes for the upper and lower ovens.

The control will exit the Diagnostic Service Mode after one minute or it can be ended by pressing the CANCEL keypad. The service mode can be restarted if necessary by repeating the steps outlined above. While the control is in the Diagnostic Service Mode the error codes can be cleared from memory by pressing the Upper Oven Timer keypad. Once they are cleared they can not be recalled.

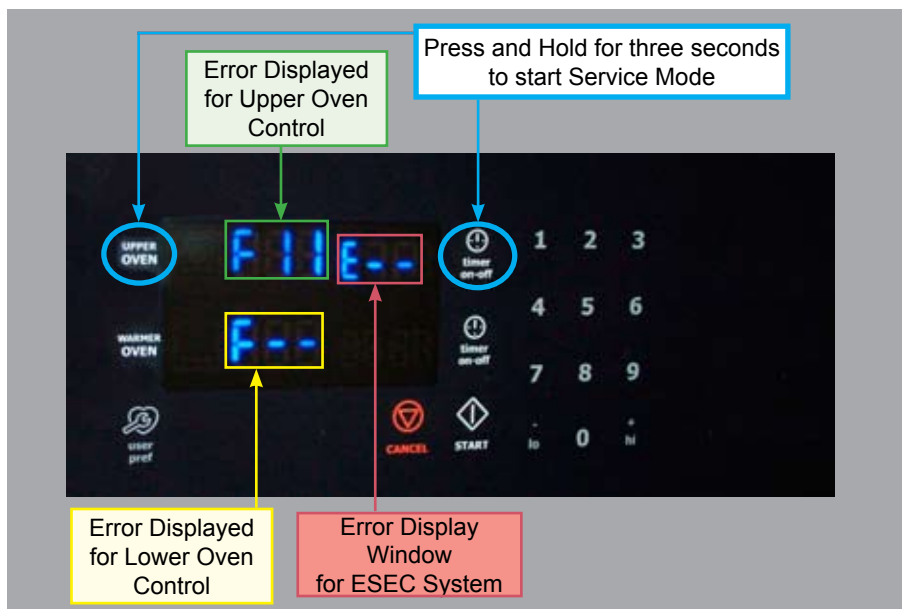

The photo above shows an EOC that has been programmed into the Diagnostic Service Mode. The upper oven control is displaying an F11 error code (Stuck Keypad), The lower oven control is displaying no error code.

The display window to the right of the F11 code is used to display error messages related to the ESEC (Electronic Surface Element Control) system found in electric ranges. In gas ranges this window will display E - - in the diagnostic service mode.

Once it has been determined which failure condition is present follow the troubleshooting steps outlined in the tech sheet and this service manual to correct that specific condition.

ELECTRONIC OVEN CONTROL (ES630)

The Electrolux branded ranges covered in this manual feature the ES630 Electronic Oven Control (EOC) . This control system is comprised of the Electronic Oven Control Board, Oven Relay Board, and Power Supply Board. The ES630 control interfaces with the TST (Touch Sensor Technology) panel to allow the consumer to select the desired function and options.

There are currently two different versions of the TST control panels sometimes referred to as “A” and “B” versions. Other terms used to refer to the different control styles are: “Wave-Touch™” for the A model and “ IQ Touch™” for the B model.

All Dual Fuel ranges feature the Wave Touch control panel.

The Wave-Touch™ display panel has a “sleep mode” that turns off the illuminated control icons on the touch panel whenever the range is idle for 2 minutes (Diag A). During this sleep mode only the time of day will be illuminated in the control panel.



To wake the control simply touch the glass surface. The touch control keypads will illuminate to allow the user to program the desired function (Diag B).

In current models the Wave-Touch control is always used on ranges that feature the “Perfect Pair™ lower oven”, also referred to as a Mini Oven.



EOC Troubleshooting and Testing

The Electronic Oven Control system found in the Electrolux freestanding dual fuel ranges uses a separate oven relay board to power the individual components such as the bake and broil element, lock motor, lower oven element, etc. This is different from some other styles of electronic oven controls where the EOC and control relays are integrated in to a single component. The servicer must follow the troubleshooting and diagnostic information found in this manual and in the product tech sheet to accurately diagnose any failures and avoid unnecessary parts replacement.

Photo A shows the locations of the EOC Board, Oven Relay Board and Power supply board as seen from the rear of the range with the rear panel removed. The ribbon connectors to the TST panel can be seen at the bottom of the EOC circuit board.

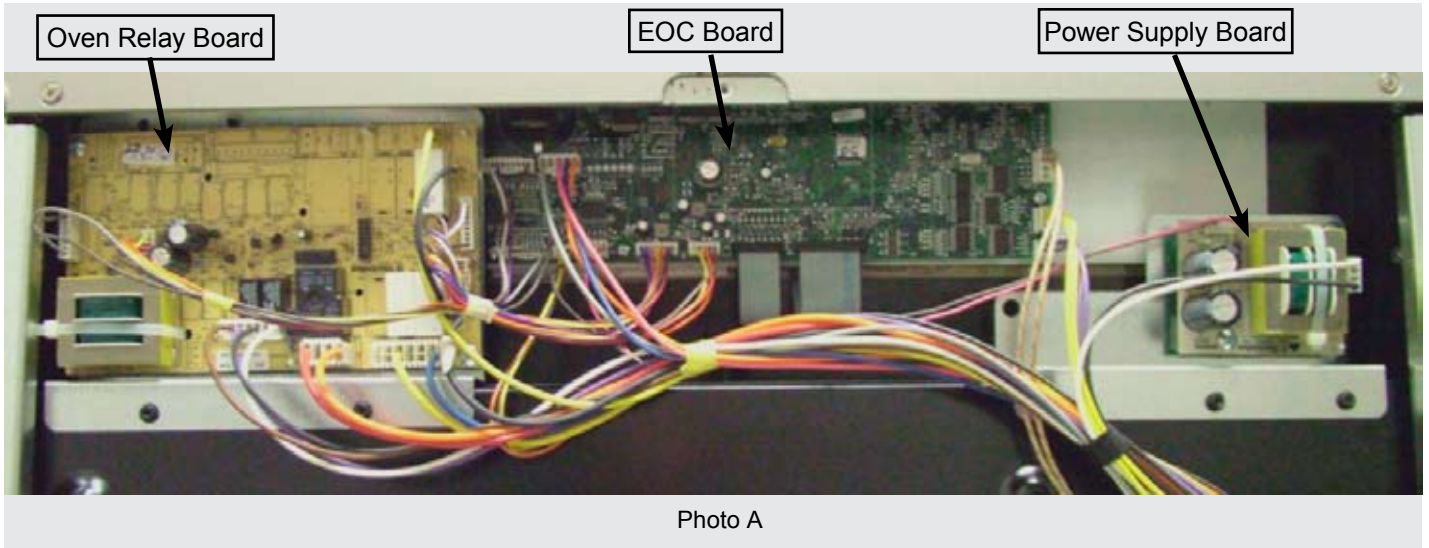

Power Supply Board

The EOC is powered by separate power supply board that is mounted on the rear of the range chassis to the right of the EOC as seen in photo B.

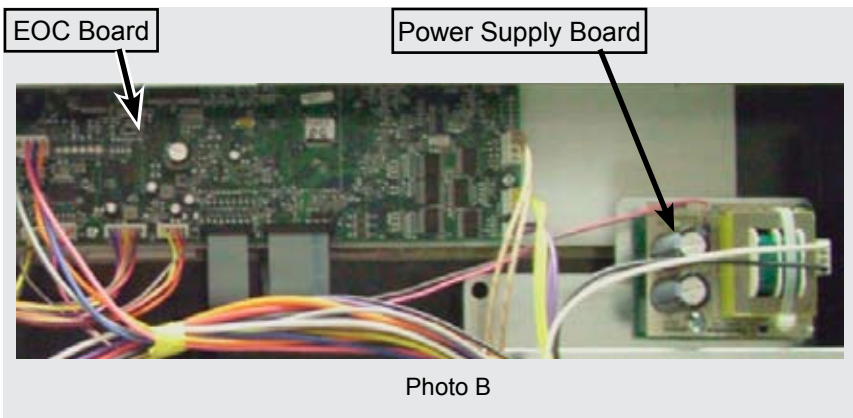

Incoming voltage to the boards should be approximately 120 VAC at P1. Output voltage should be approximately 8 VDC at P2.

Always test the incoming and outgoing voltage at the power supply boards when troubleshooting EOC or ESEC control failures.

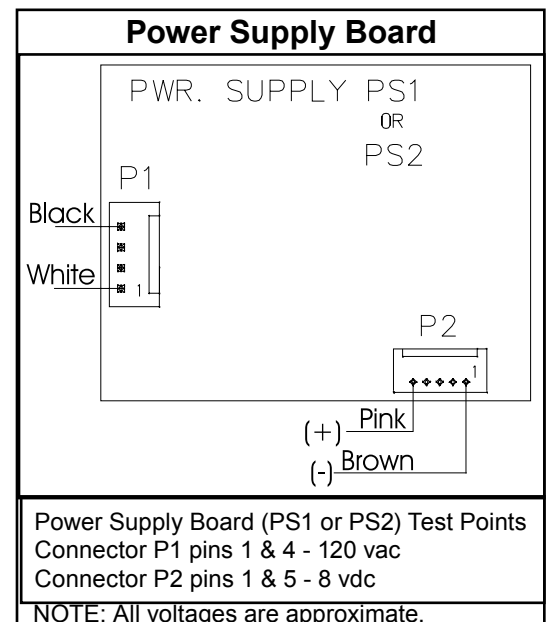

ELECTRONIC OVEN CONTROL (ES630)

Oven Relay Board

If a component part that is controlled by the EOC fails to operate the cause could be due to a defect in the EOC, Oven Relay Board, wiring connections, or the non functioning component. Component parts like elements, fan motors, lock motors, etc. can be tested with a simple continuity check using an ohm meter. Verify the continuity of the component and the wiring circuit between the component to the relay board first. Also verify continuity of the wiring harness and connectors between the EOC and Oven Relay Board.

If the component and wiring connections are good, test the output signal voltage from the EOC to the Relay board for the particular relay that turns on that component part. When testing the output signal set your volt meter to read DC voltage. The output signal will be approximately 3.3 volts DCV.

Using the **EOC SIGNAL VOLTAGE TEST MATRIX** it is possible to determine if the EOC is properly signaling the relay board to turn on a particular component. If the proper signal is detected but the relay does not close then the relay board is defective and must be replaced. If the proper signal is not detected then the EOC is defective and must be replaced.

EOC Signal Voltage Test Matrix (ES630) - Dual Fuel Ranges		
Test for 3.3 VDC (+/- .5 volts) between GND on EOC circuit board and the indicated connector pin when the specified function is activated.		
FREESTANDING ELECTRIC MODELS, and DUAL FUEL MODELS		
FUNCTION	EOC Test Points Connector/Pin#	Relay Board Test Points Connector/Pin #
Lower Oven or Warmer Drawer	P9/Pin7 → to GND	J5/Pin 7 → to GND
L2 Out Relay	P11/Pin4 → to GND	J7/Pin 4 → to GND
Broil Relay	P11/Pin 1 → to GND	J7/Pin 1 → to GND
Bake Relay	P11/Pin2 → to GND	J7/Pin 2 → to GND
Convection Element Relay	P11/Pin5 → to GND	J7/Pin 5 → to GND
Lock Motor Relay	P11/Pin6 → to GND	J7/Pin 6 → to GND

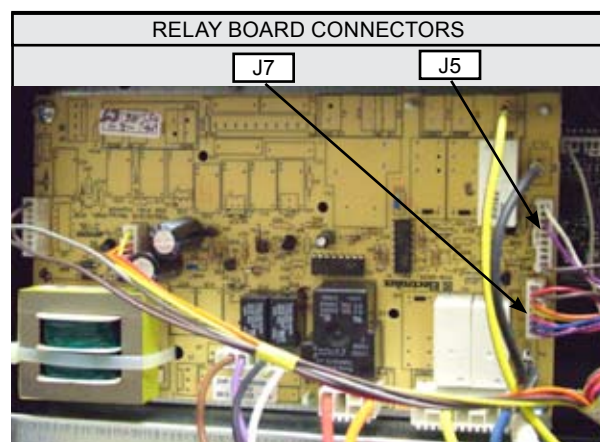

When testing the signal voltage from the EOC the negative (-) lead of the test meter must connect the GND circuit on the EOC circuit board. The easiest access point to the GND circuit is located just above the left corner of the P11 connector. (Photo A).

Photo B demonstrates testing the Bake Relay signal voltage by measuring the voltage output between connector J7 pin #2 (red wire) and the GND circuit on the EOC circuit board on a gas range.

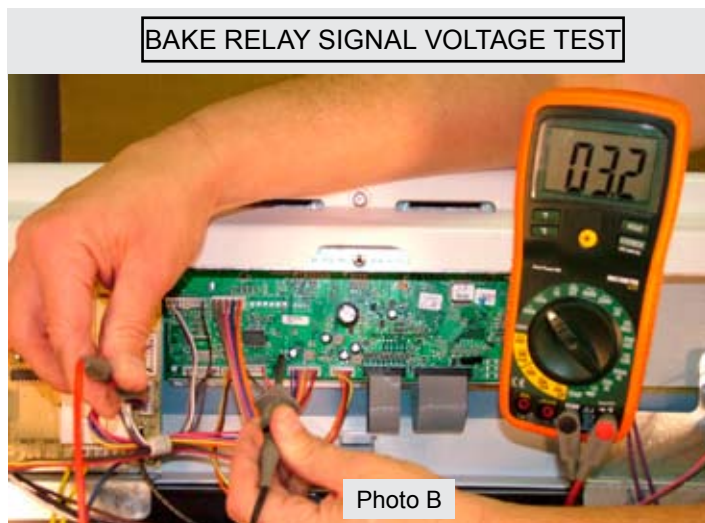
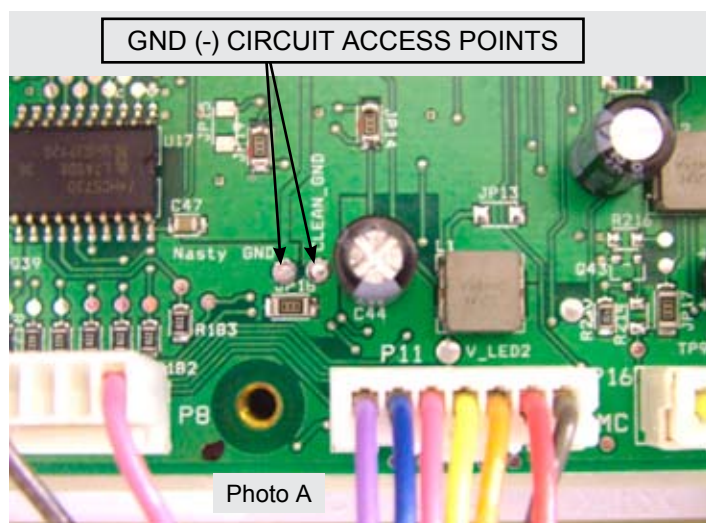

VARIABLE SPEED CONTROL

The Variable Speed Control (VSC) board operates the Convection Fan as well as the Oven LUXURY™ lighting. In the event that either of these features do not operate properly the VSC board should be examined as a possible source of failure.

Variable Fan Speed

To achieve optimum cooking results during convection cooking the fan motor speed can be varied. The EOC will signal the VSC board to speed up or slow down the fan as needed. This speed change takes place automatically with no action required by the consumer.

The VSC Board is located on the rear of the range as seen in photo A. The board varies the voltage to the convection fan motor as directed by the EOC to alter the motor speed. The speed control signal and the power supply to operate the VSC board come from the EOC through a wiring harness connected between P2 on the EOC and P1 on the VSC board. This harness must be intact and properly connected for the VSC board to operate. If the harness is defective or not properly connected the EOC will display a fault code F23.

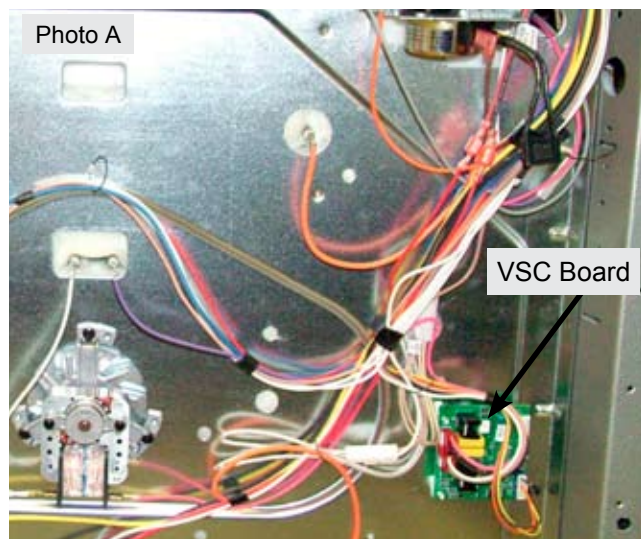

When testing the VSC board the power supply from the EOC to the board can be verified by measuring the voltage between pins 1 & 6 (the two outside pins) on connector P6 of the VSC board. This connector is not wired in field applications and the pins are easily accessed to test voltage while the other harness connectors are in place and power is applied to the range. Test for approximately 5 volts DC (+/- .5 volt) on these two pins. If the EOC appears to operate normally but the voltage to the VSC board is incorrect or if there is no voltage present inspect and test the wire harness and connectors between the EOC and VSC board. If the harness is good then the EOC is defective and should be replaced.

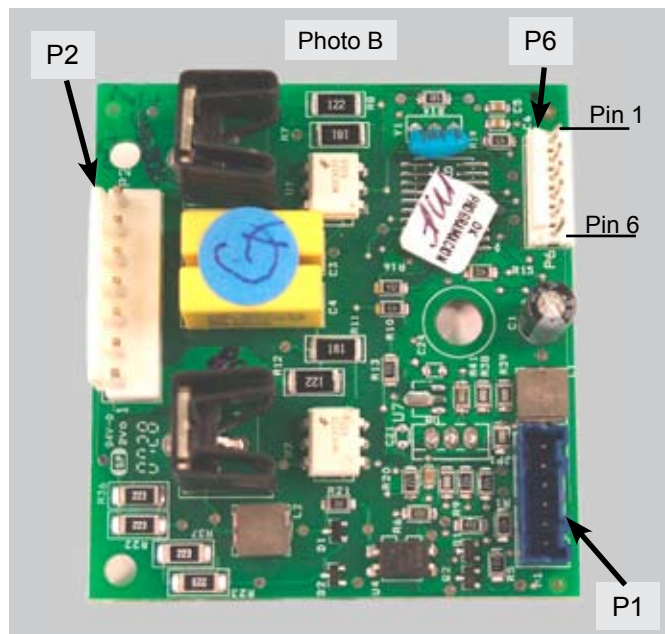

If the convection fan motor fails to run test for voltage to the convection fan motor. If no voltage is present then the failure is either in the VSC board, EOC, or the wiring in between. If there is proper voltage to the fan motor but it does not run then either the motor windings are open or the motor is stuck. Test the continuity of the motor windings with an ohm meter. There should be approximately 15 ohms of resistance in the convection fan motor windings. If the windings test good inspect the fan blade and motor shaft to see if the motor will turn. Adjust the fan blade to eliminate binding or replace the motor assembly if the motor shaft is seized.

LUXURY™ Lighting

When the oven door is opened or the LIGHT keypad on the touch control panel is pressed the interior oven halogen lights (photo B) come on and brighten gradually. When turned off they dim gradually until they are completely off. This feature is also sometimes referred to as “Ramp Up lighting”.

The incremental changing of the oven lights is controlled by the VSC board. A triac on the board gradually increases the voltage to the lights over a 2 - 3 second time span until the lights are on at full power.

If none of the halogen oven lights operate, plug in the range and open the oven door. Test for approximately 120 volts AC at pins 1 & 3 of the P2 wire harness connector (brown & white wires) on the VSC board (photo C).

Always use special care when making live voltage tests.

If the voltage is correct then the failure is caused by defective bulbs, sockets or wiring connections. If the voltage is incorrect the problem could be caused by a defective door switch, VSC board, or EOC.

Test the contacts of the oven door switch by disconnecting the P10 connector on the EOC and checking for continuity between the grey and pink wires in the wire harness.

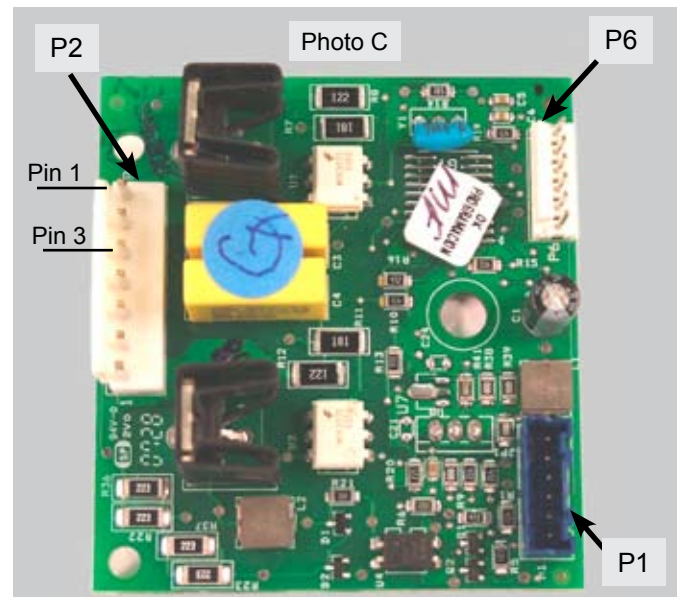
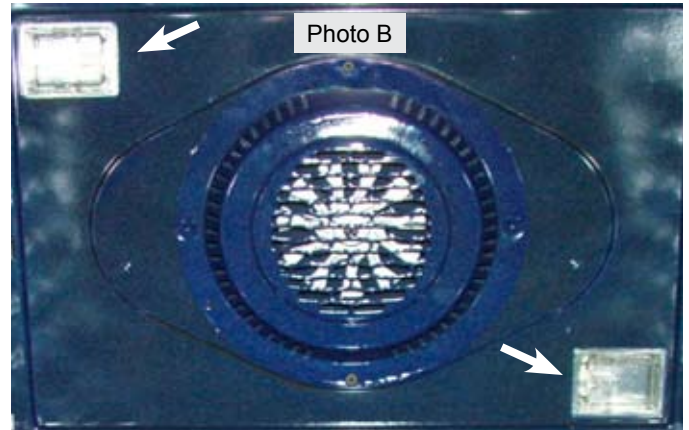

RACK SENSING SWITCH

In order to prevent damage to the extendable telescoping interior oven racks, the EOC will not perform a self clean cycle until the racks are removed. A rack sensing switch mounted in the rear of the oven liner signals to the EOC that the racks have been removed. (Photo A)

When the oven racks are installed the rear edge of the rack pushes against a pivoting rod on the rack sensor assembly causing a cam on the rod to depress the sensor switch. When the switch is depressed the switch contacts are open. As long as the switch contacts are open the EOC will assume that the racks are installed in the oven.

When the racks have been removed the cam of the sensor rod releases the pressure on the rack sensing switch allowing the switch contacts to close. When the EOC detects that the rack sensing switch contacts are closed it will allow the self cleaning cycle to operate.

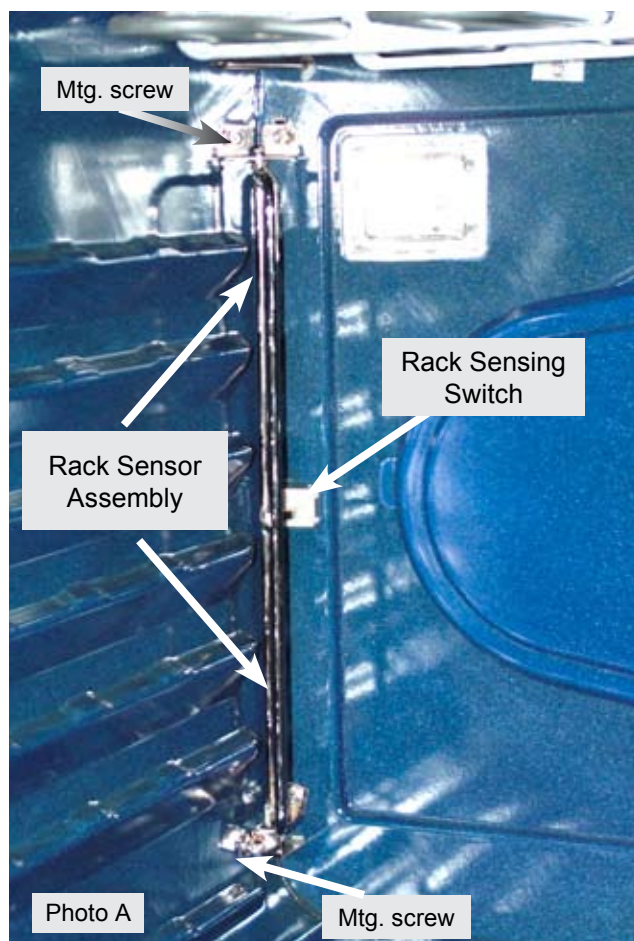

If the customer starts a self cleaning cycle without removing the racks a message on the EOC will illuminate instructing them to remove the racks. (Photo B).

If the racks have been properly removed but the EOC displays the **REMOVE RACKS** message then the failure could be caused by defective switch contacts, wiring harness connections, stuck sensor rod assembly or defective EOC.

Examine the sensor assembly rod to be sure it can move freely. Also inspect the metal plunger cover on the switch to make sure it has not stuck. The sensor rod assembly can be removed for cleaning and lubricating if necessary.

If the sensor switch becomes stiff or hard to depress the metal cap may need lubrication on the underside at the contact point of the switch plunger.

Use only an approved, water based graphite lubricant on the sensor assembly and switch. Part number is 5304468694 and is available through your authorized parts distributor.



RACK SENSING SWITCH

To test the rack sense switch contacts remove the rear wire cover on the range and access the wire harness connector P10 on the EOC. (Photo A)

Unplug the harness and test for continuity between the blue & grey wires in the harness. When the racks are removed there should be less than 1 ohm of resistance if the switch contacts are closed.

If the switch contacts are closed but the EOC displays the "REMOVE RACKS" message then the EOC is defective.

If the switch contacts are open then test the switch through the harness plug on the switch itself. Unplug the harness connector (Photo B) and test for continuity between the brown wires of the harness.

If the switch contacts are open replace the switch. If the switch contacts are closed then the harness from the switch to the EOC is defective.

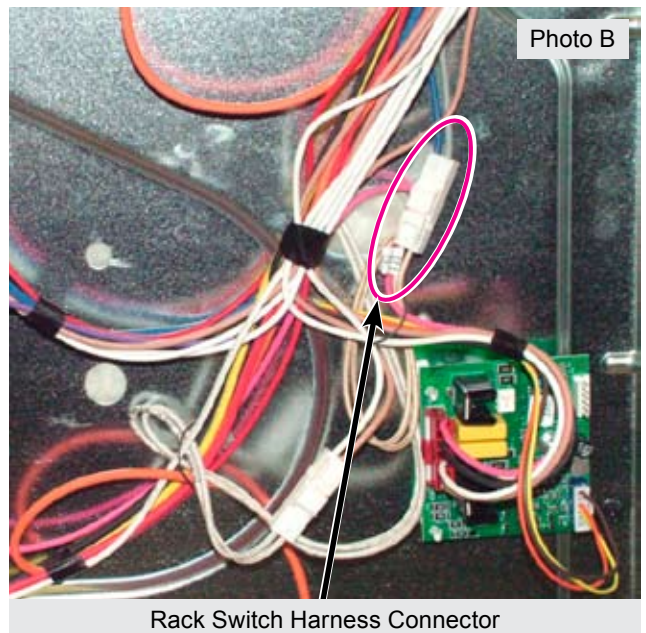

MEAT PROBE FEATURE

Theory Of Operation

Some models feature a meat probe that is used to monitor the internal temperature of the food during cooking. The meat probe is a RTD (Resistance Temperature Device) similar to the oven temperature sensor found in ranges with electronic oven controls. As the temperature of the meat probe increases the resistance decreases. The E O C monitors this resistance whenever the probe is inserted into the receptacle and uses this information to determine when the food has reached the target temperature.

Component Parts

The components of the meat probe feature are: Probe assembly (Fig 1) and the receptacle assembly which includes the wire harness (Fig 2).



Troubleshooting

Possible failures of the meat probe feature are:

- Loose wire or harness connection.
- Defective meat probe.
- Defective receptacle and wiring harness.
- Defective Electronic Oven Control.

To troubleshoot the meat probe feature first test the probe itself by using an ohm meter to measure resistance. Place one of the meter leads on the very tip of the probe plug and the other lead on the adjacent short segment as indicated in the photo.

The resistance will vary depending on the actual temperature of the probe. At a room temperature of 77 degrees the resistance will measure approximately 46,000 ohms.



To test the accuracy of the probe place the metal wand end into a container of water that has a temperature of 120 degrees Fahrenheit and measure the resistance. At 120 degrees the resistance should be between 17,860 ohms and 19,740 ohms. If the resistance is incorrect replace the probe. If the probe resistance is correct plug the probe into the receptacle inside the oven and disconnect the probe harness connector from the E O C connection P 18.

Measure the resistance between the two wires in the harness plug. If the resistance is approximately equal to the resistance of the probe then the harness and receptacle circuit are good.

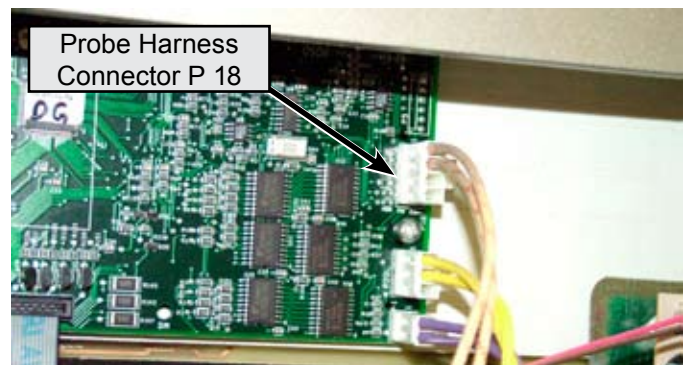

If the resistance is significantly higher or lower than that of the probe then the receptacle and wiring harness should be replaced. The receptacle and wiring harness are replaced as an assembly. If the probe, receptacle and harness are good but the probe feature does not work the failure is in the E O C and it must be replaced.

COMPONENT ACCESS AND REPLACEMENT

OVEN DOOR

All components and parts of the Oven Door assembly can be serviced or replaced. The door is not available as a complete assembly. Service procedure is identical for Wave Touch and IQ Touch models.

To service the door begin by removing the door from the range. Open the door fully and pull both hinge locks down until they stop. (Photo A & B)



Gently close the door until it stops against the hinge locks at approximately a 45 degree angle. (Photo C)



Make sure you have a firm grasp on the door and continue closing the door to disengage the hinges from the receivers. (Photo A)



When the door is about 4 inches away from being completely closed it can be lifted off the range. (Photo B)



To reinstall the door reverse the previous steps. Use your knee to stabilize and help guide the hinge arms into the receiver slots in the frame. Once the door is secure in the frame open it fully and close the hinge locks back in to their normal position.

Door Disassembly

To service or replace the door components remove the door as previously described and place the door on a protected work surface with the handle side down.

Begin disassembly by removing the two screws at the top of the porcelain door liner (Photo C),

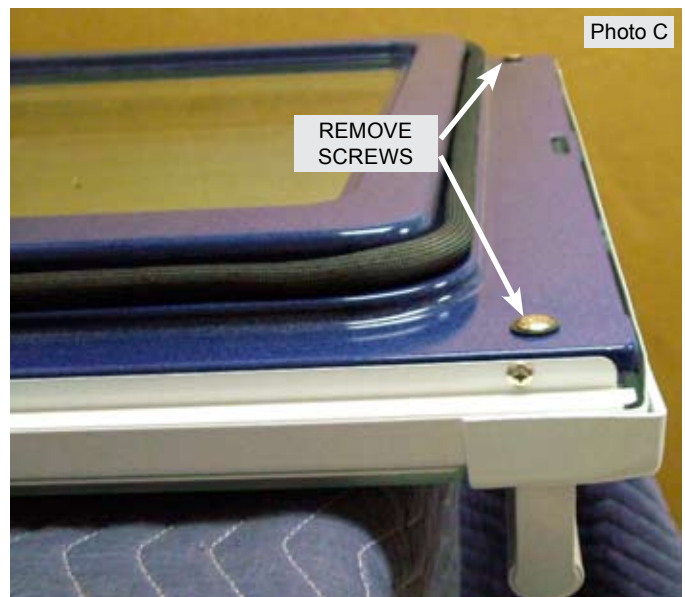

Carefully turn the door over so that the handle side is facing up. Remove the four screws located along the bottom edge of the door. (Photo A)
Lift off the outer glass panel with door handle and top trim cap attached.



To remove and replace the door handle or top trim cap remove the two screws on the back side of the trim cap that secure the cap and door handle to the door panel outer glass . (Photo B)



The outer door panel is replaced as an assembly which includes the metal frame with outer glass, foil tape and name badge already attached. If the foil tape is not already attached install it around the window opening as seen in Photo C.

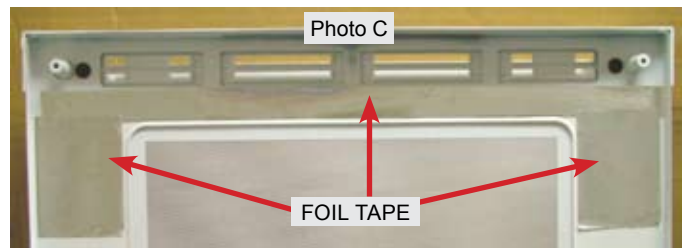

With the outer door panel remove the door filler trims can be removed by taking out the two screws found in each trim. (Photo D)

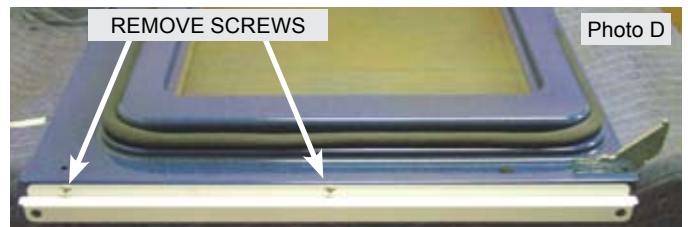

Remove the air wash glass and mounting brackets by removing the four screws that secure the brackets to the porcelain door liner. (Photo A)

NOTE: The mounting brackets may be attached to the top or the sides of the airwash glass depending on model.

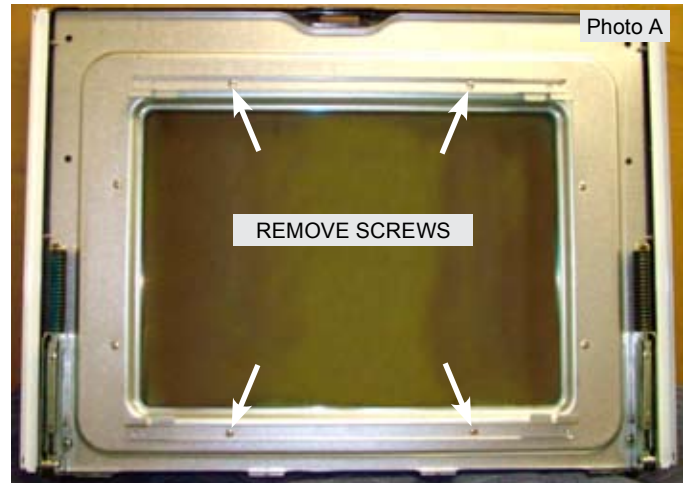

To remove the door hinge remove two hinge mounting screws from the outside of the porcelain door liner and pull the hinge out from the back. (Photo B)

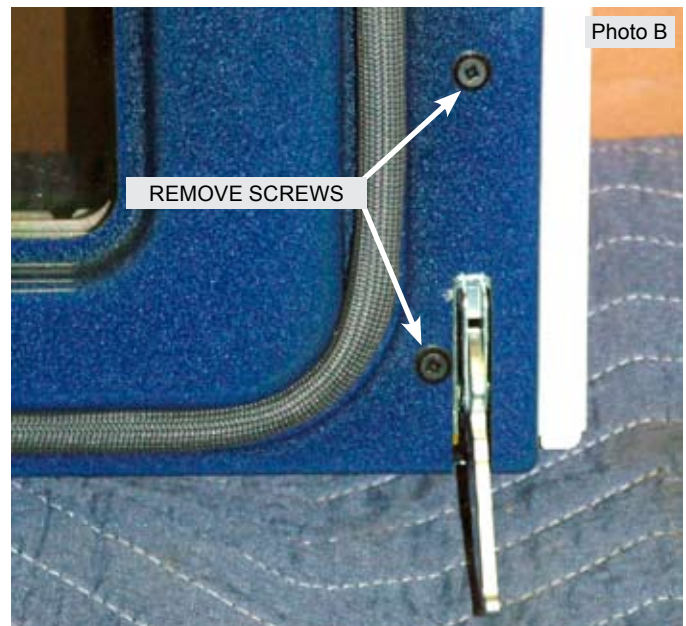

The hinges used in different models have the same general appearance so to help identify the hinge a color stripe is painted onto the spring. (Photo C)

When replacing the hinge make sure that the spring color matches the color stated in the parts description from the part list.



7316508700 Hinge Assembly, door, blue

Remove the wool shield by taking out the remaining four screws securing the shield to the door liner. (Photo A).

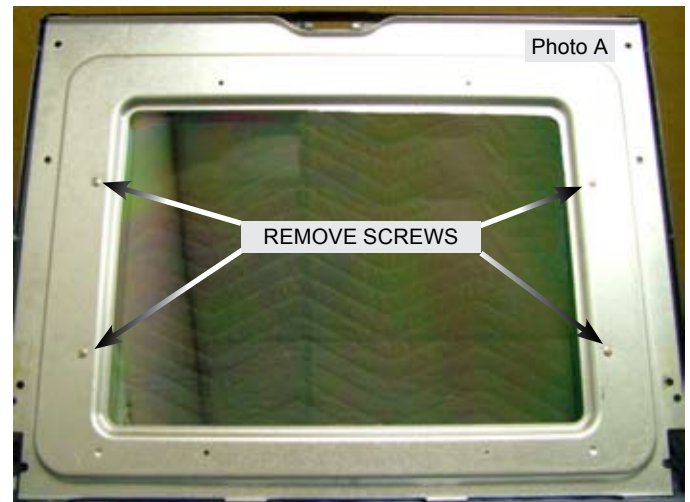

When reinstalling the wool shield be sure that the bottom edge of the shield is nested under the upturned edge of the porcelain door liner. Photo (B)

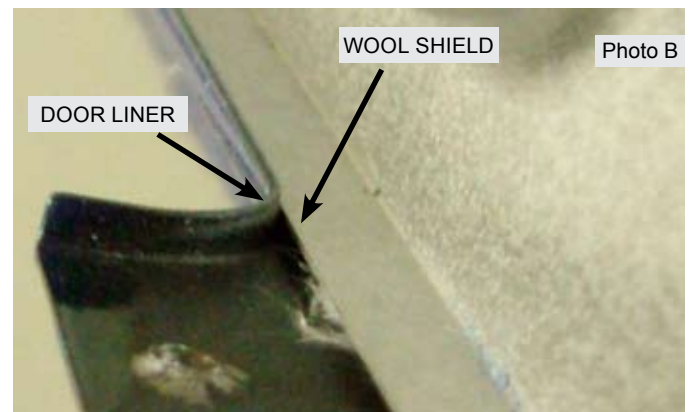

Carefully lift out the four pieces of insulation surrounding the window cutout. When reinstalling the insulation take care to tuck the insulation under the screw brackets on the porcelain liner. (Photo C)



Lift out the two inner door glass panes and their spacer leaving only the porcelain door liner with door gasket still attached.

The gasket is secured to the liner by spring clips that can be pulled out from the opposite side. Make sure to re-insert the loose ends of the gasket into the holes at the bottom of the door liner before reinstalling the inner door glass panes or insulation. (Photo D)

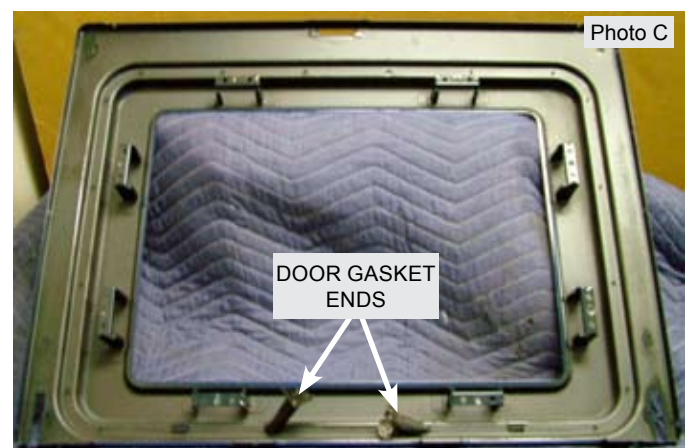

Cooktop Removal - Dual Fuel Models

To remove the cooktop for service first remove the grates and burner caps as seen in photo A.



Lift the right front burner off the cooktop and place it aside. The remaining burners are secured to the top with a single screw in each burner. (Photo B). Use a #1 square drive bit to remove these mounting screws at each burner orifice assembly. Lift off the four remaining burners and place them aside.

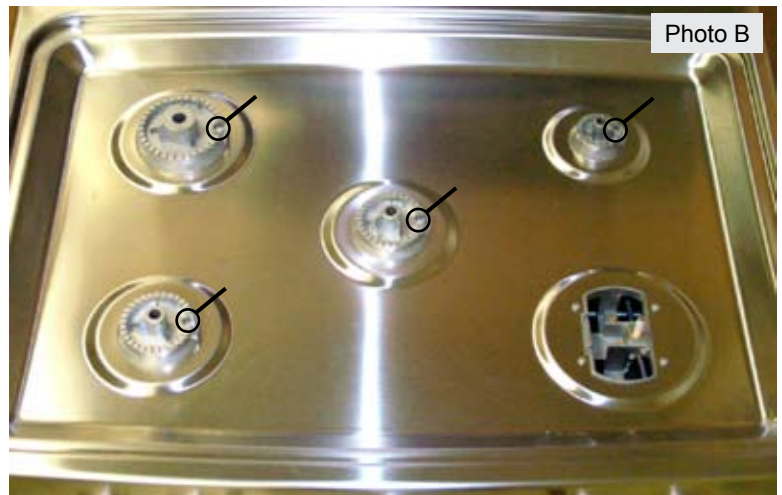

The burner orifice holder assemblies are secured to the top by one screw in each assembly with the exception of the right front orifice holder which has four screws. (Photo C)
Use a #1 square drive bit to remove these mounting screws at each orifice holder assembly.

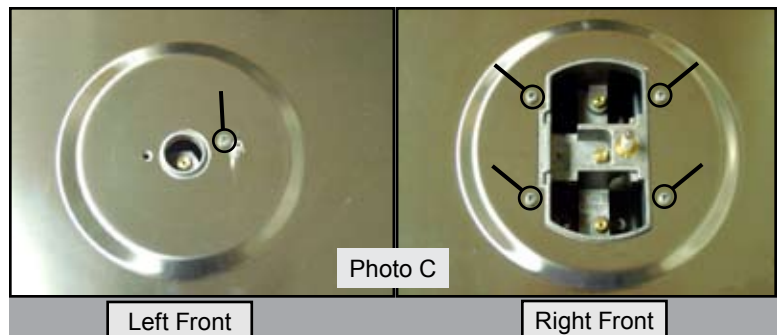

When reinstalling the burner caps on Wave Touch model gas ranges you must align the grooves on the underside of the cap with the vanes on the burner. (Photo D)

The cap can must be properly aligned in order to be fully seated. (Photo E)

The right front dual burner and cap do not have alignment vanes or slots.

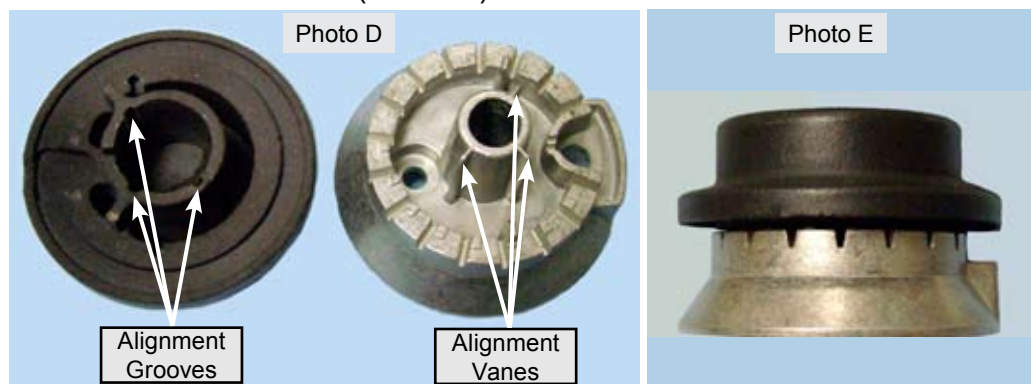

Cooktop Removal - Dual Fuel Models

Insert a putty knife or similar tool between the main top and manifold panel near the outside of the front corner. Push the putty knife toward the rear to release the maintop mounting clip (Photo A). Repeat for both sides.



When the mounting clips are released the front edge of the cooktop can be lifted upward. (Photo B)



Make sure that the orifice assemblies and ceramic ignitors do not bind in the cutouts in the cooktop when raising the top to remove it from the range. (Photo C)

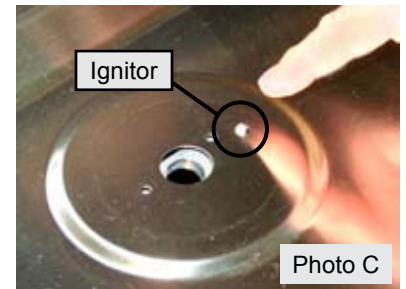

Lift the front of the cooktop and pull forward to disengage the back edge from the rear hinge brackets on each side of the range. The cooktop can then be lifted clear of the range. (Photo D)

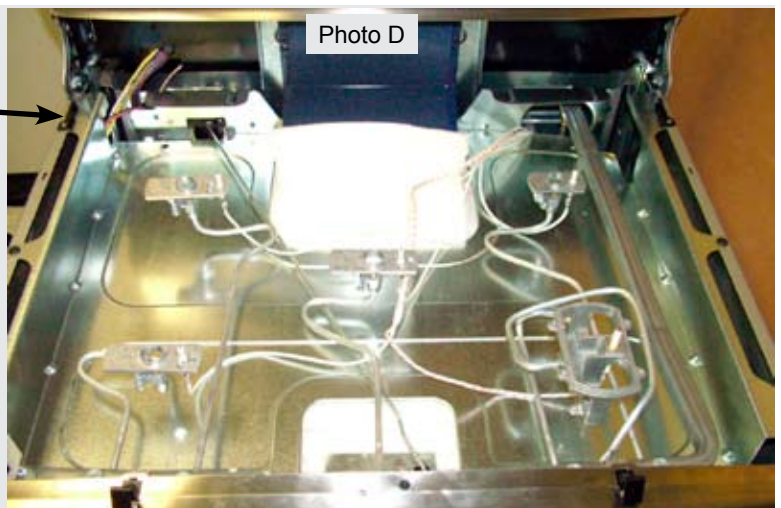

Orifice Holders

Once the cooktop has been removed the individual orifice holder assemblies are accessible for service. (Photo A)

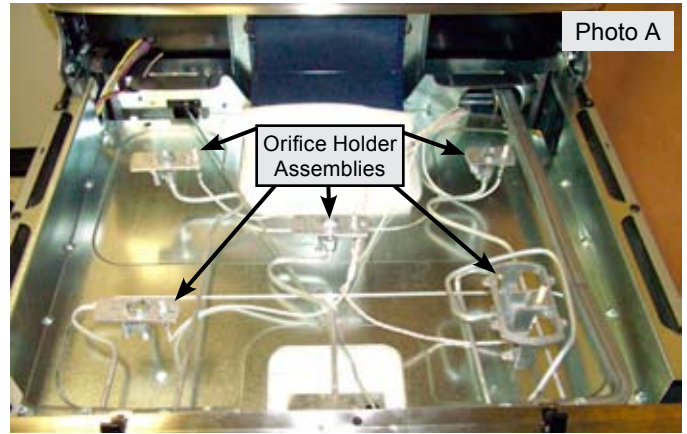

Each orifice holder assembly is connected to the burner valve by a compression fitting on the end of the gas supply line. (Photo B) The supply line is part of the orifice holder assembly. Use care when removing and installing the compression fitting onto the burner valve.

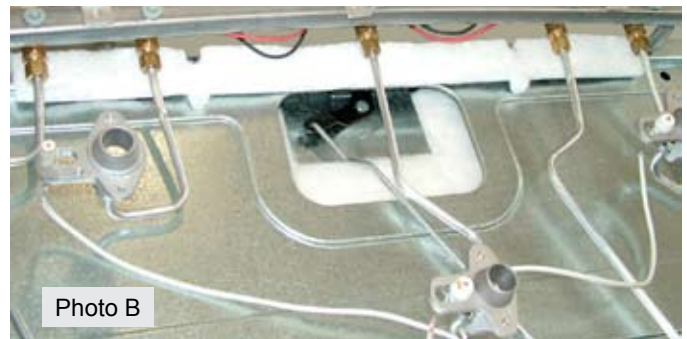

When disconnecting the ignitor wire from the ceramic ignitor on the orifice holder you must depress the locking tab in order for the terminal connector to release.

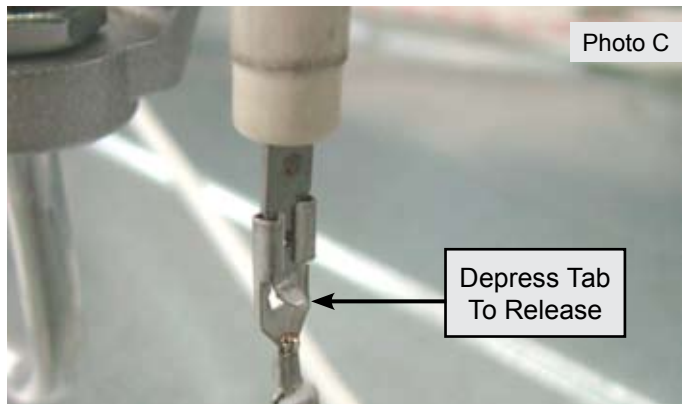

Removing Manifold Panel

Remove the four mounting screws indicated in photo D on the underside of the manifold panel. Remove the burner valve control knobs by pulling them straight forward off the valve shafts.



Next remove the 1/4" hex head screws securing each of the main top mounting clips. Remove the 1/4" hex head screw in the center of the manifold panel and remove the panel from the range. (Photo E)

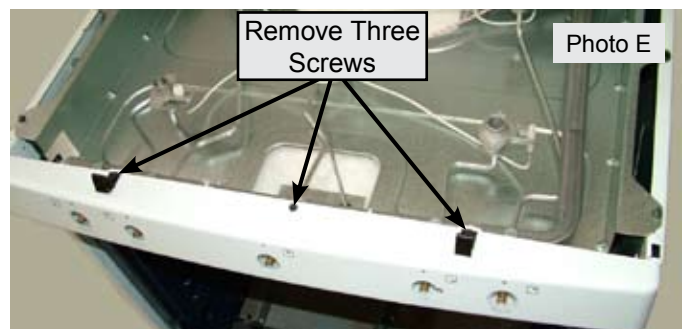

With the manifold panel removed the surface burner ignitor switches and harness are accessible. The wire harness and switches are replaced as a complete assembly.

Replacing Ignitor Switches and Harness

To remove the switches and harness from the burner valves loosen the wire twist ties that secure the wire harness to the manifold pipe. (Photo A)

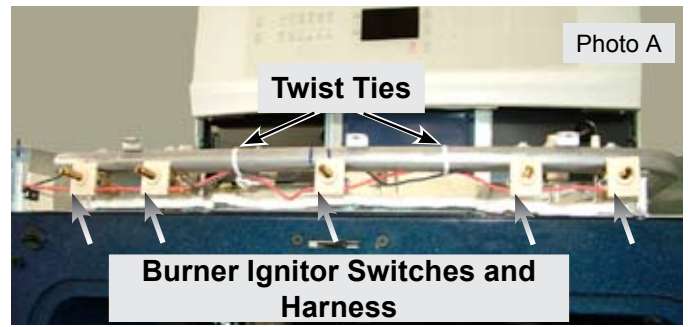

Pull forward to unsnap the switch housing from the valve. (Photo B).

When replacing the switches make sure that the switches snap securely and lock to the valve body. The slack in the wire harness should lay under the manifold tube and secure with the wire twist ties as shown in the photo.



Replacing Surface Burner Valves

Disconnect the compression nut that secures the orifice holder assembly gas line to the valve. Remove the valve mounting screw from the top side of the manifold tube. The valve can now be pulled out of the manifold tube from the bottom.

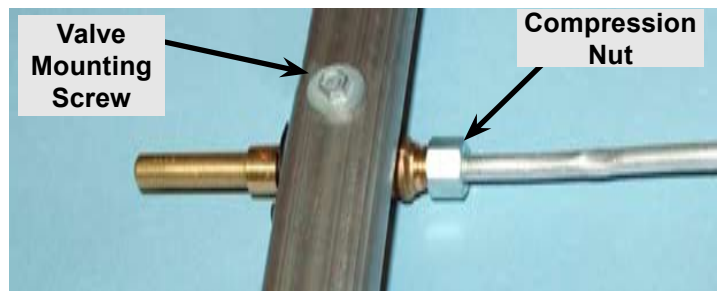

IMPORTANT NOTE: When reinstalling the burner valve always insure that the washer on the burner screw and valve body is undamaged and properly positioned

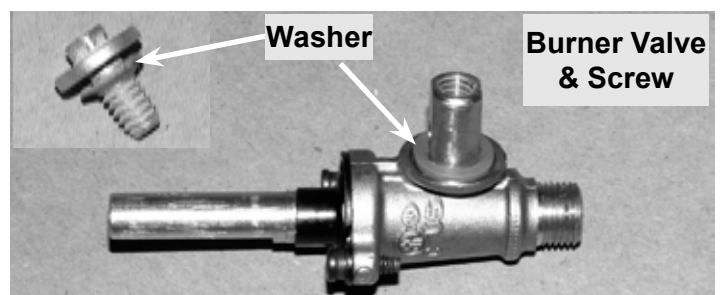

UPPER OVEN COMPONENTS

Luxury Glide Oven Rack Removal & Maintenance

To remove and replace the Luxury Glide oven racks open the oven door completely. Locate the spring loaded plunger below the rack bearing channel on each side of the rack. (Photo A).



Using your thumbs push both plungers in at the same time to unlock the rack. (Photo B). Pull the rack assembly forward to remove it from the oven.

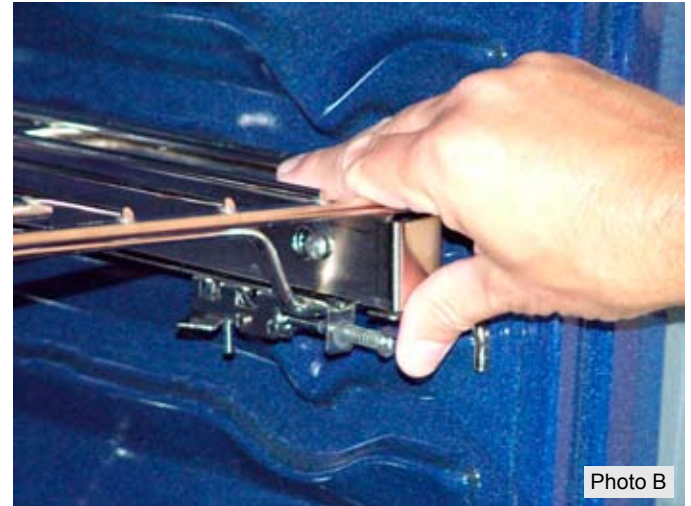

The Luxury Glide Oven Racks have no serviceable parts and should be replaced as a complete assembly if defective. The ball bearing glide assemblies on the oven racks should be lubricated annually or more often as needed. Use only the approved water based graphite lubricant. NEVER use grease or oil of any kind to lubricate the racks or bearings. Approved lubricant is available through your authorized Electrolux parts supplier under part number 5304468694. This lubricant should also be used on the rack switch sensor rod assembly

To lubricate the bearings remove the racks as described in the owners manual. Place the rack on a protected work surface and slide the rack to the fully extended position to expose the ball bearing assembly inside the track. Using the dispenser tip of the lubricant bottle place a few drops of lubricant on the top and bottom bearing carriers in the areas indicated by the arrows in photo C. The lubricant will be spread to all of the ball bearings as the rack is operated. Use the lubricant sparingly, a few drops is all that is necessary.

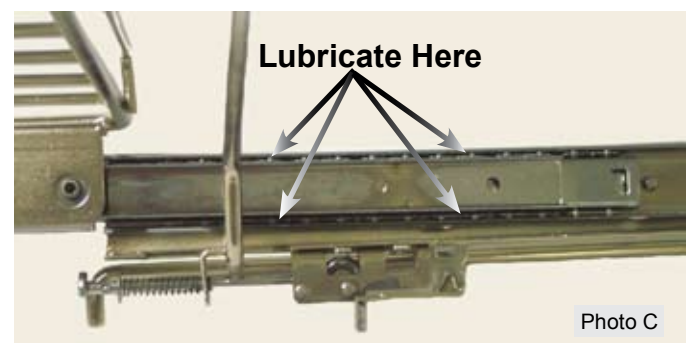

Repeat this process for each bearing assembly. There are two bearing assemblies on each side of the rack, one on the inside as seen in the photo and one on the outside. Also lubricate the rack release plunger mechanism at all friction points as needed.

Rack Sensor Assembly Removal & Maintenance

The pivot points of the oven rack sensor assembly should be lubricated annually or more often as needed.

Use only the approved water based graphite lubricant available through authorized Electrolux parts dealers. NEVER use grease or oil of any kind to lubricate the rack sensor assembly.

To lubricate the assembly remove all oven racks from the inside of the oven. Use the dispenser tip of the lubricant bottle to place a few drops of lubricant at the pivot points of the rack sensor assembly bar. (Photo A)

Use the lubricant sparingly, a few drops is all that is necessary.

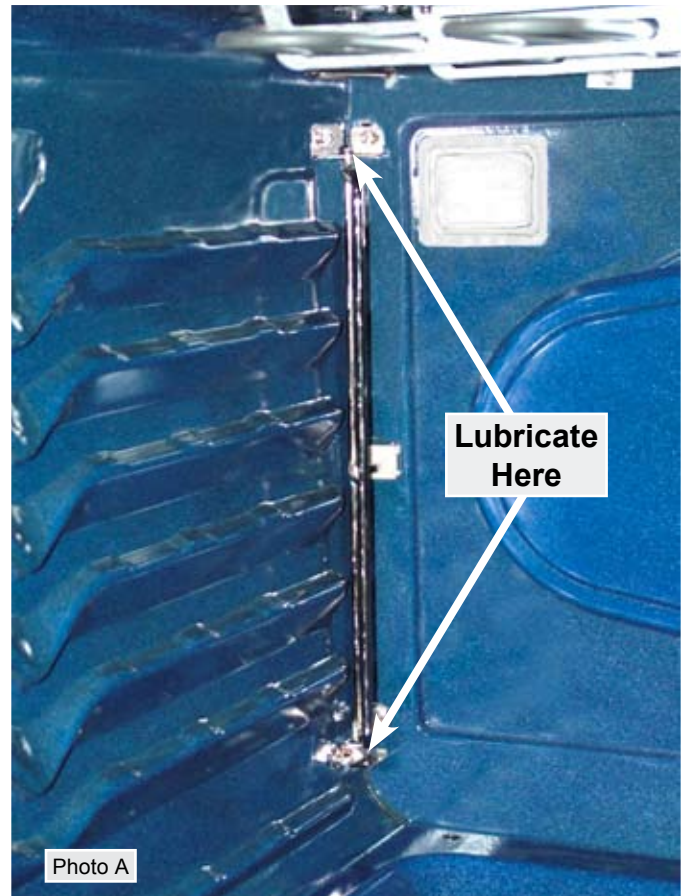

To remove the rack sensor assembly begin by taking out the two screws in the top mounting bracket and lifting the bracket and sensor assembly rod out of the lower bracket. (Photo B). The lower bracket can now be removed if necessary.

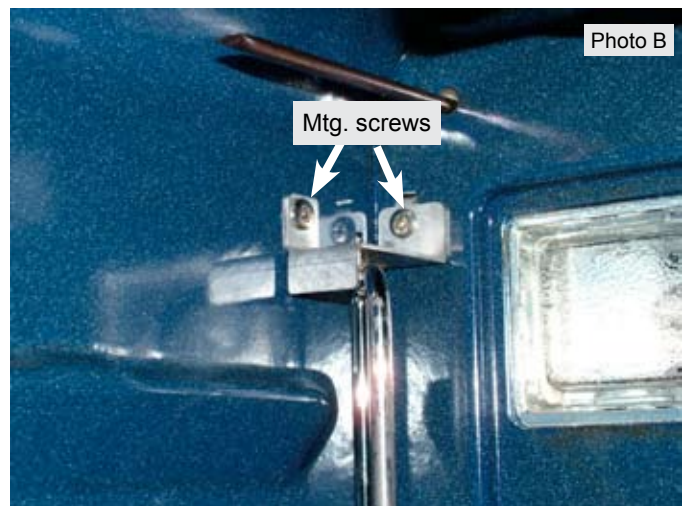

UPPER OVEN COMPONENTS

Bake Element

To remove and replace the bake element remove the oven door and all interior oven racks. Remove the rack sensor assembly by taking out the two screws in the top mounting bracket and lifting the bracket and sensor assembly rod out of the lower bracket. (Photo A)

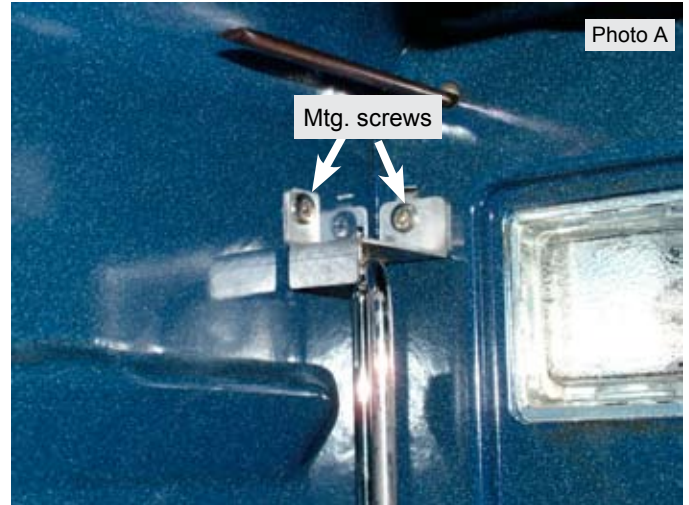

Remove the two screws that secure the convection fan cover to the rear of the oven wall and remove the cover. Remove the two screws at the rear corners of the oven bottom panel. (Photo B)

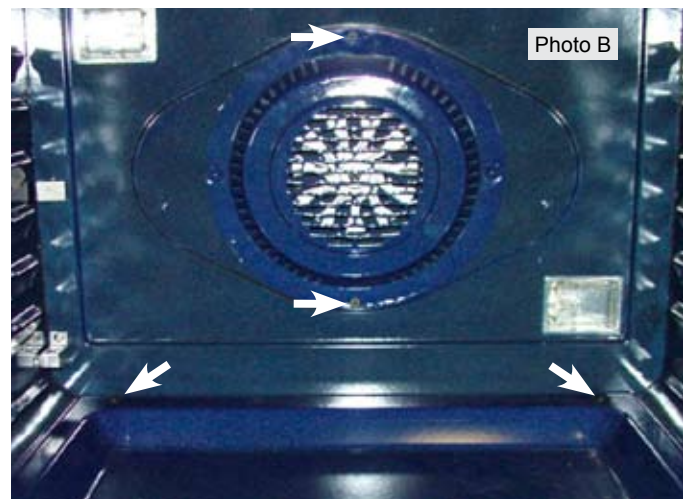

Using your finger tips press down on the front edge of the oven bottom to cause it to lift upward in the rear of the oven cavity. (Photo C).



Lift the rear of the oven bottom upward and slide it toward the rear oven wall to disengage the front edge from the chassis. Remove the oven bottom. (Photo D)



Bake Element

The bake element is eight pass, 240 volts, 3000 watts. It is secured to the oven liner by the four screws indicated by the arrows in Photo A.

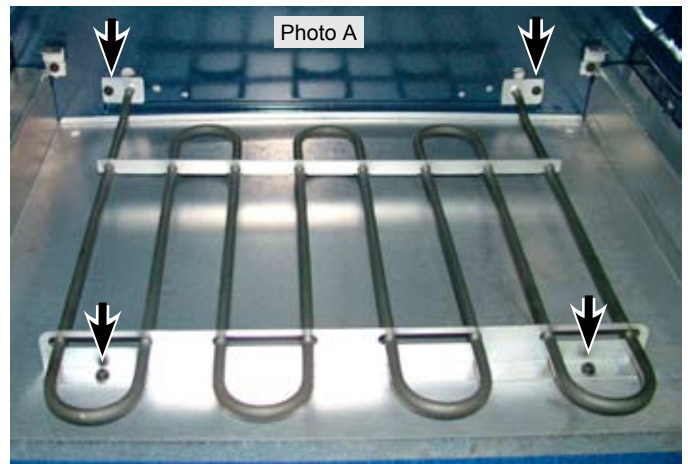

Before removing the bake element disconnect the element wires which can be accessed by removing the lower rear shield on the back of the range. (Photo B)

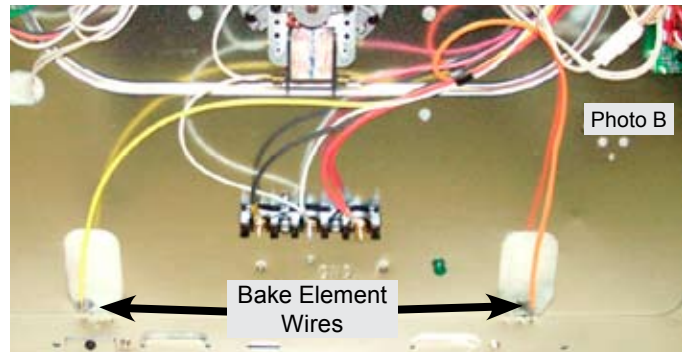

Broil Element

The broil element is eight pass, 240 volts, 4000 watts. It is secured to the oven liner by the six screws indicated by the arrows in Photo C.

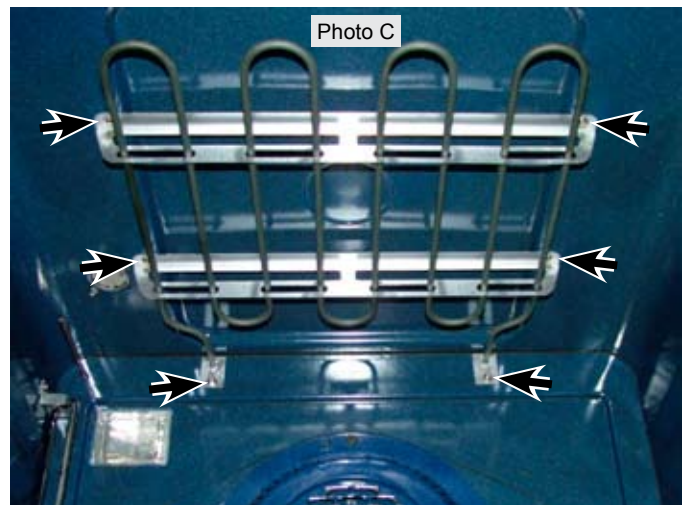

Before removing the broil element disconnect the element wires which can be accessed by removing the lower rear shield on the back of the range. (Photo D)

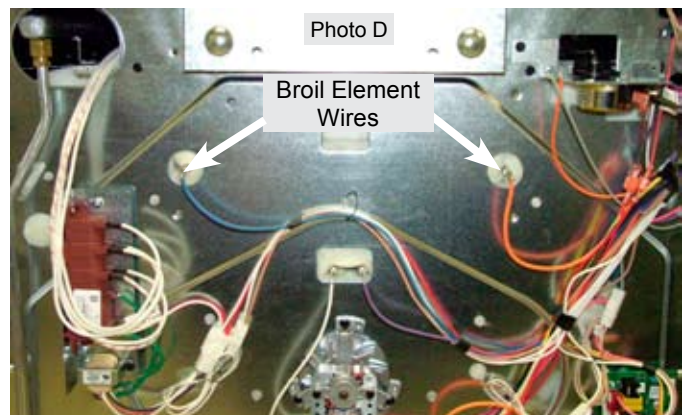

Convection Fan Blade and Element Replacement

The Convection Fan Blade and Element are concealed by the fan cover. Remove the cover as described on page 33.

The Blade can be removed by using a 13mm socket wrench to remove the blade retaining nut. The nut has left hand threads so to remove the nut turn the wrench in a clockwise direction. (Photo A)

The convection element is a single pass, 120 volts, 350 watts. It is secured to the oven liner by the two screws indicated by the arrows in Photo B.

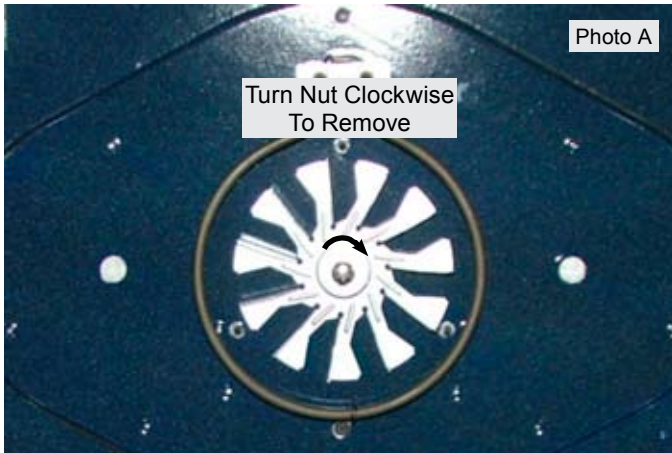

Before removing the convection element disconnect the element wires which can be accessed by removing the lower rear shield on the back of the range. (Photo C)

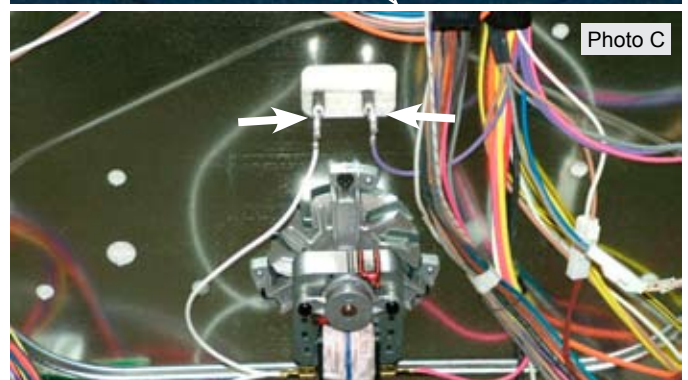

Rack Sensing Switch Replacement

The rack sensing switch is installed into a cutout in the oven liner rear wall. (Photo D)

To replace the switch first turn off the power to the range and remove the lower back cover panel. Unplug the harness connector (Photo E) and tie a 36 inch length of strong string or cord to the end of the connector that is attached to the switch. Secure the other end of the string so that it can not pull all the way through.

From inside the oven remove the rack sensor assembly by taking out the two screws at the top and bottom of the assembly. (Page 32 - Photo B).

Depress the tabs on the switch (Photo D) to release it from the cutout and carefully pull the switch with the attached wire harness inside the oven cavity. Attach the string to the new switch harness and carefully pull the harness back through the oven liner and insulation .

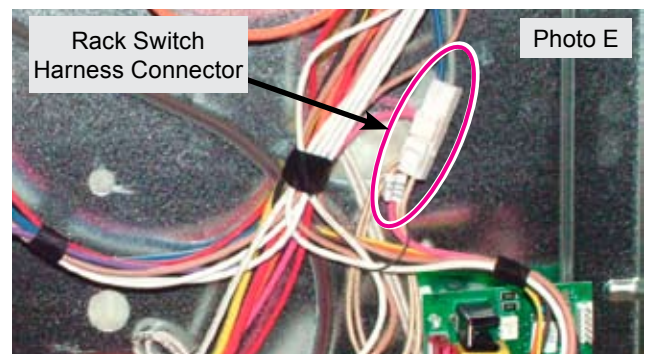
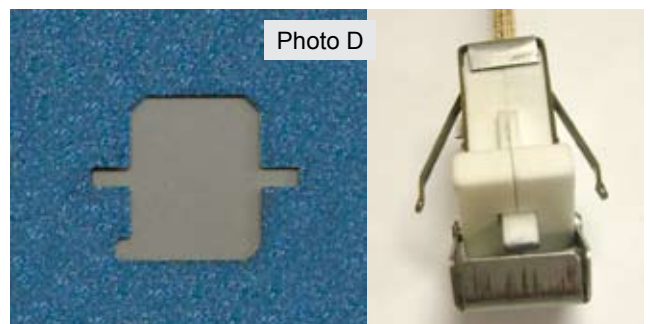

Halogen Oven Lights

Each light assembly houses a replaceable 40 watt bulb behind the clear lens.

To remove the lens use a thin bladed screwdriver or putty knife to gently pry the lens out. Take care not to damage the finish of the oven wall. (Photo A)

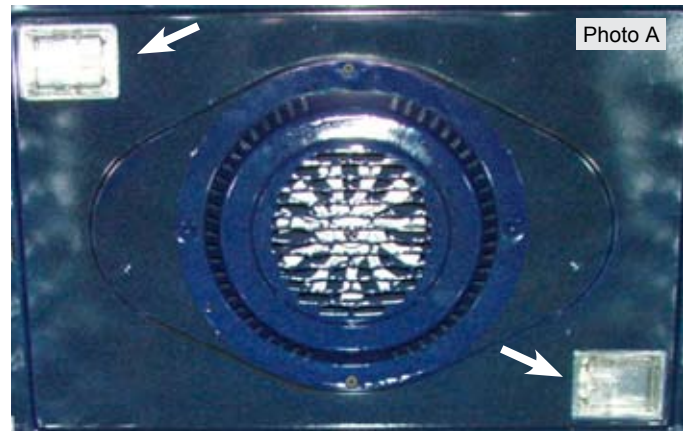

Photo A

With the lens removed the bulb can be accessed. Remove the bulb by pulling it out of the porcelain base in the direction shown by the arrow in photo B. Use only the correct replacement bulb.

Please note: do not allow your fingers to touch the new bulb when replacing. This will shorten the life of the new bulb. Use a paper towel to cover the new bulb when installing.

If the socket or harness are defective the complete assembly with attached harness, bulb and lens must be replaced. The light assembly is installed from the inside of the oven cavity.

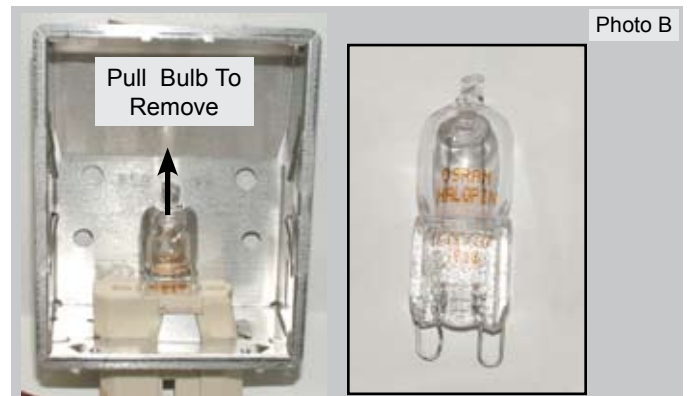

Photo B

When removing the old assembly it is recommended to tie a string to the end of the harness plug as the assembly is being removed. This string can then be used to fish the wire harness of the replacement assembly through the oven cavity liner and inner shield.

Always orient the assembly with the wire harness towards the center of the oven. (Photo C)

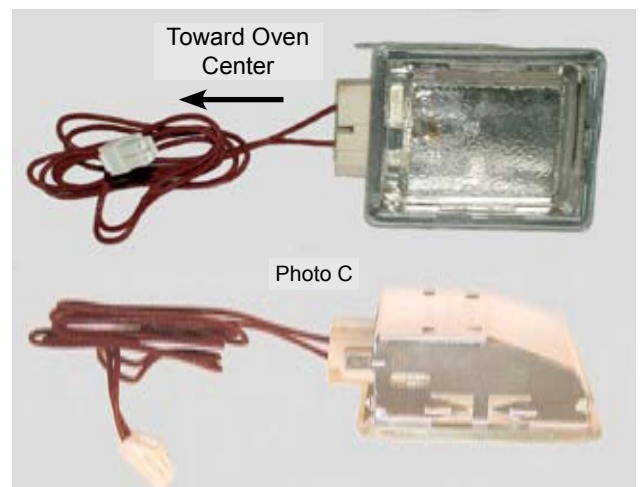

Photo C

LOWER OVEN COMPONENTS - DUAL FUEL MODELS

Replacing Lower Oven Element

Remove Drawer

1. Before drawer removal, be sure to turn OFF the lower oven and let the drawer area cool completely.
2. Open the drawer to the fully open position. Using a phillips-head screwdriver remove the two drawer screws from the insides of the front oven drawer compartment (See Fig. 1).
3. With one hand hold the drawer front in place. Use your other hand to pull the glide away from the oven (See Fig. 2) until the glide hook disengages (See Fig. 3 & Fig. 4).
4. Repeat from step 3 above for the other side of the drawer.
5. With both glide hooks disengaged, carefully lift the drawer up and away from the oven. Push both drawer glides into lower oven cavity.

From the rear of the range remove cover plate just to the right of the regulator by taking out the screw at the top of the plate. (Photo A)
Lift the plate upward to remove.

With the cover plate removed the wire harness terminal connectors to the lower oven heating element and lower oven light socket are accessible. (Photo B)
Unplug the element harness connectors.

With the drawer removed and the element wire harness disconnected remove the seven screws that secure the element to the base and remove the element by pulling forward. (Photo C)
To remove the mounting screws a short / stubby 1/4" nut driver or # 1 square drive screwdriver is required.

Use caution when working in this area. There are sharp edges on the element brackets and other areas. Protective clothing and / or gloves are recommended.

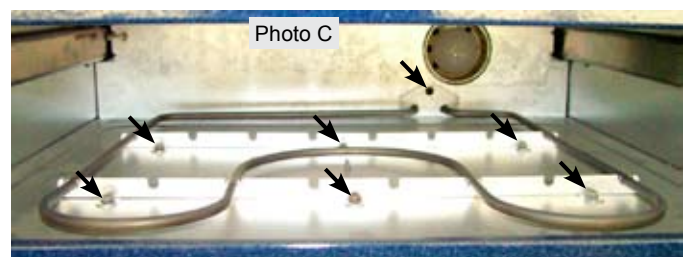
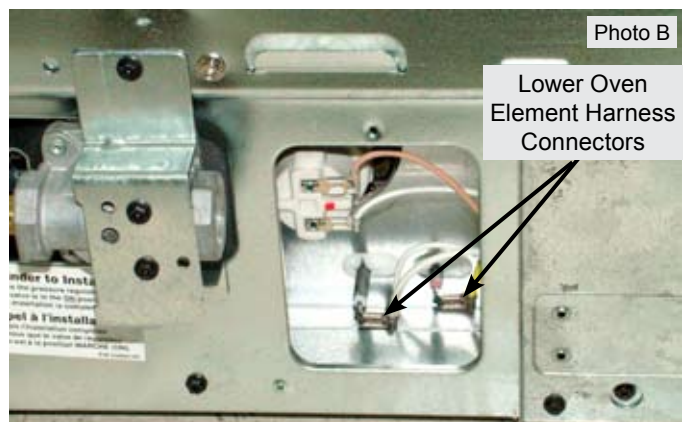
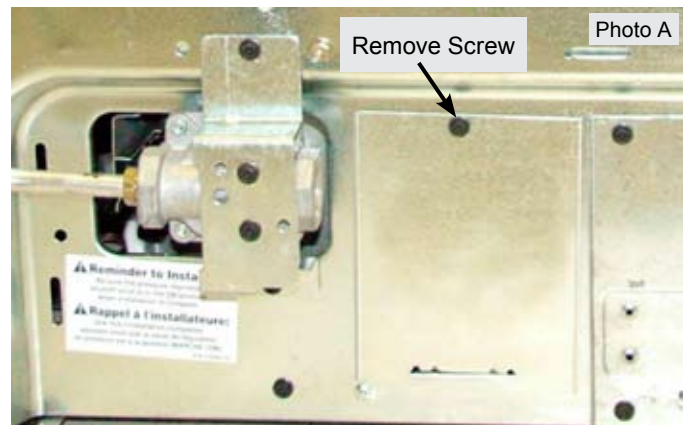
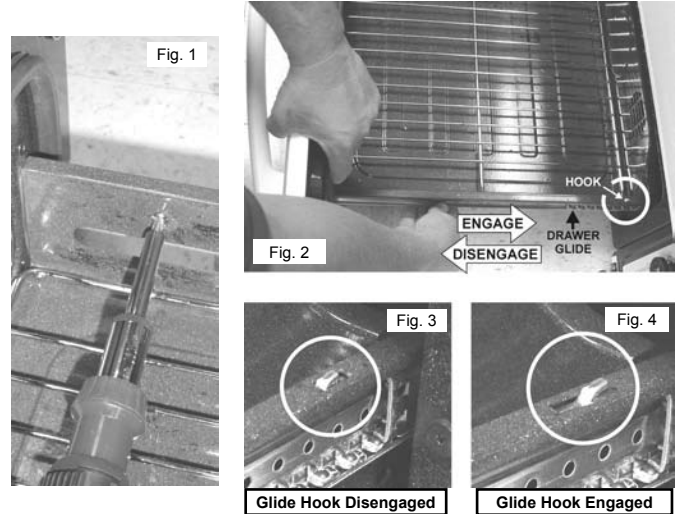

Replacing Lower Oven Temperature Probe

To remove and replace the lower oven temperature probe remove the access cover plate located at the right rear of the range when viewed from behind. (Photo A)

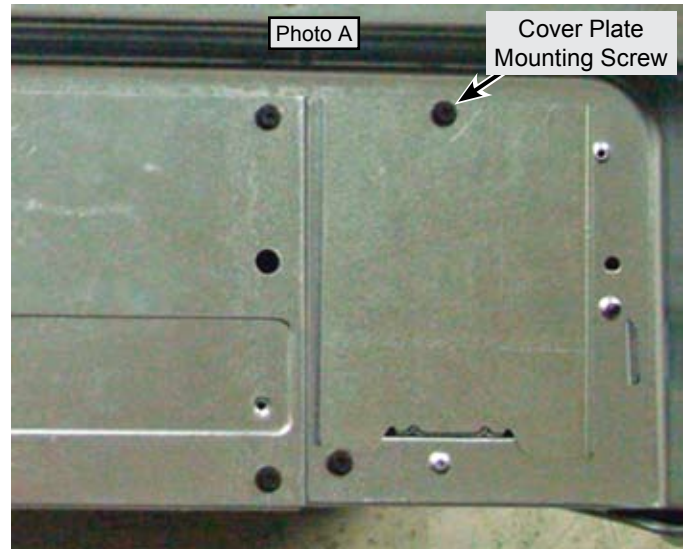

Take out the cover plate mounting screw and remove the cover.

Once the cover plate is removed the lower oven temperature probe connector can be disconnected from the harness connector on the right side of the opening. (Photo B)

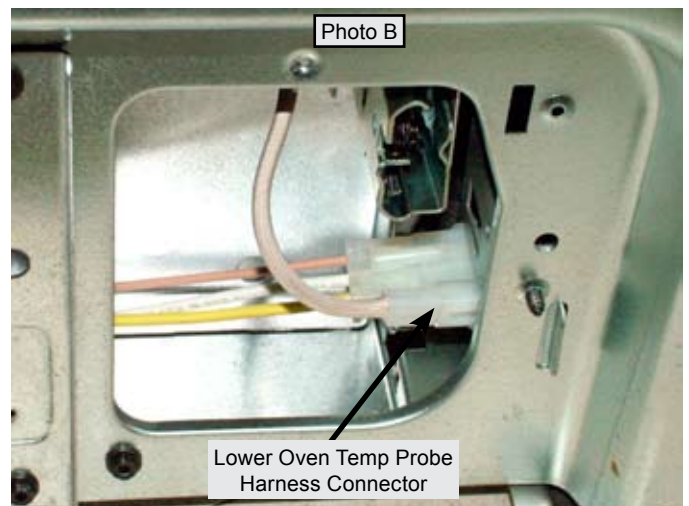

Unplug the lower oven temperature probe connector and remove the two screws that mount the probe to the rear of the lower oven chassis. (Photo C)

The probe can now be pulled out of the chassis.

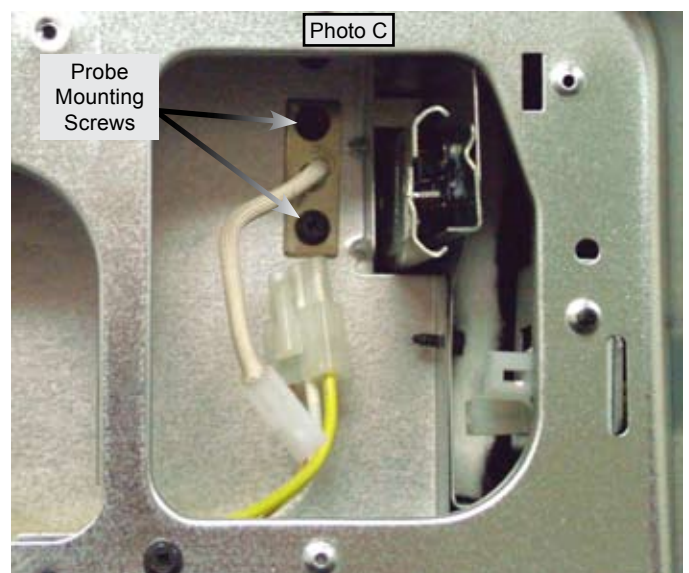

Replacing Lower Oven Thermal Cutout

The lower oven thermal cutout is located behind the access cover plate located at the lower portion of the chassis near the center of the range when viewed from behind. (Photo A)

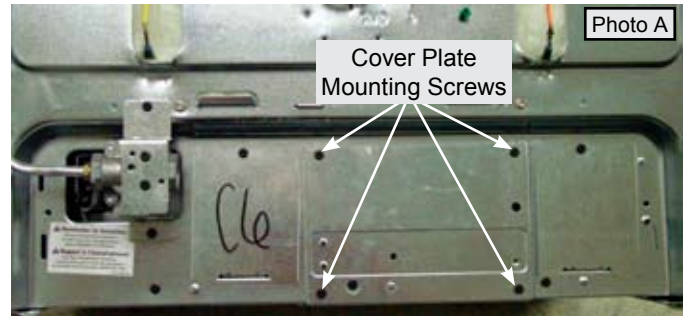

Take out the four cover plate mounting screws and remove the cover.

Once the cover plate is removed the lower oven thermal cutout and harness connections are accessible. (Photo B)

To remove the cutout, unplug the harness connections and remove the two mounting screws.

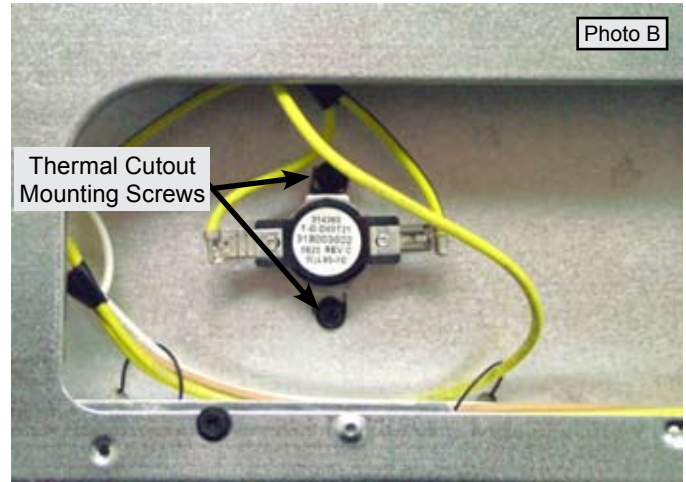

Replacing Drawer Glide Rails

The lower oven drawer glide rails (Fig. 1) clip into the side wall of the lower oven cavity and are secured by one screw in each rail.

The mounting screw is accessed through a hole in the glide rail outer track. (Fig. 2) .

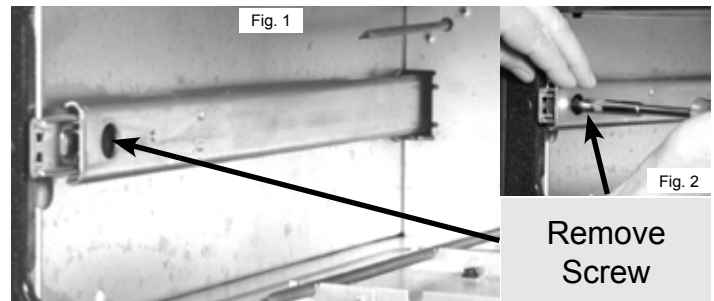

Once the mounting screw is removed extend the outer track of the glide rail until it stops. Pull forward firmly until the hooks on the back of the rail disengage from the slots in the oven cavity side wall. (Fig. 3 & 4)

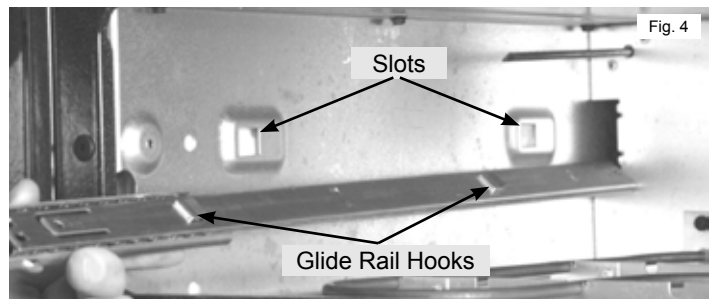
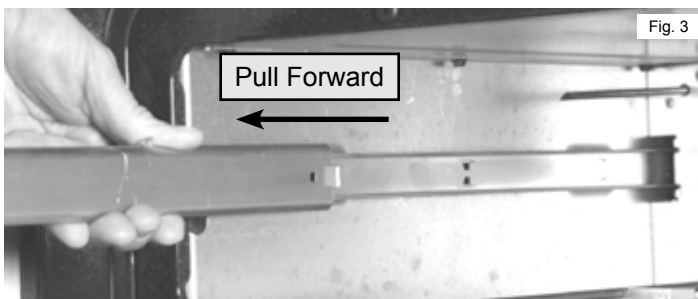

Replacing Drawer Seal

The rubber drawer seal is secured to the drawer liner by metal spring clips that are integral to the seal. To remove the seal grasp securely at the clip and pull away from the liner. Replace by positioning the point of the clip into the hole and pressing in until the clip locks into place.

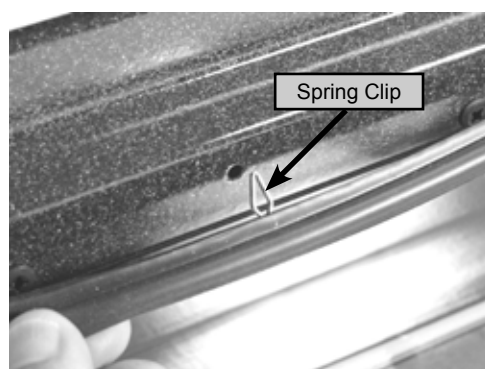

Lower Oven Chassis

The lower oven chassis can be removed as an entire assembly. Begin by removing the temperature probe harness cover plate as described on page 38.

Unplug the lower oven temperature probe harness connector and the lower oven wiring harness connector. (Photo A)

Remove the drawer per instructions on page 37.

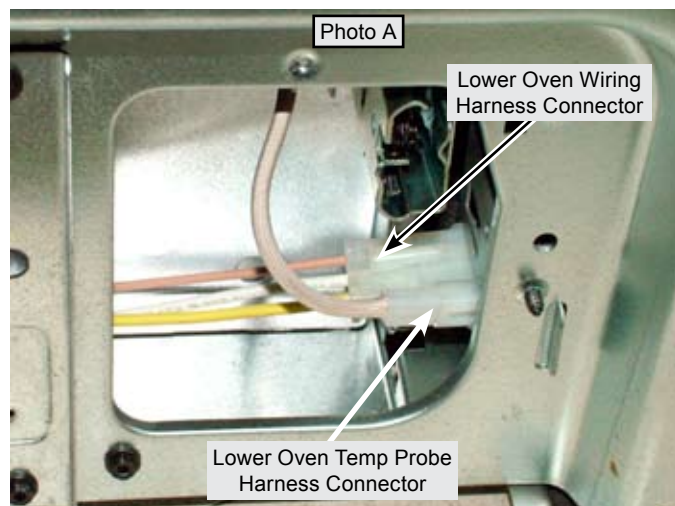

Using a 1/4" nut driver with magnetic screw holder remove the two screws securing the lower oven chassis to the range chassis.

These screws are accessed through the holes in the lower oven cavity liner just below the drawer glide rail. (Photo B).

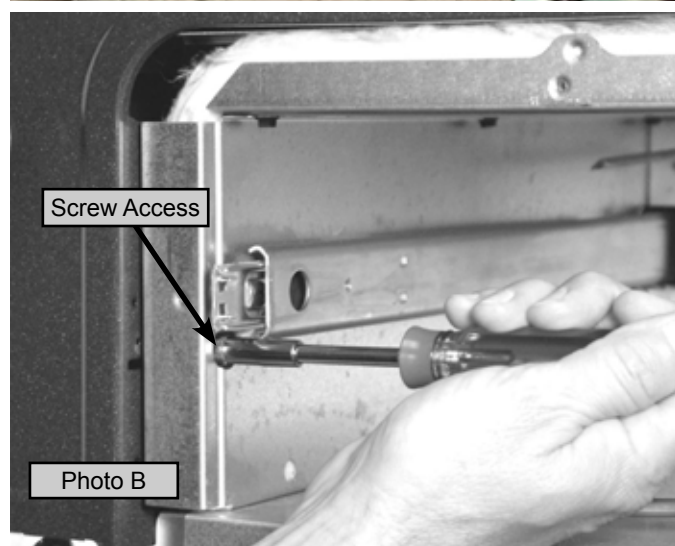

The lower oven chassis can now be pulled forward and removed from the range. (Photo C). With the lower oven chassis removed the insulation and chassis panels can be serviced.

NOTE: The lower oven chassis is not available as a complete replacement assembly.

