



TECHNICAL EDUCATION  
**2010 Whirlpool 26'  
SXS Refrigerators**



GSF26C5EXW	GSS26C5XXW
GSF26C5EXY	GSS26C5XXY
GSS26C5XXA	GSF26C5EXS
GSS26C5XXB	GSF26C5EXT

JOB AID W10338921

# FORWARD

This Job Aid, Whirlpool Gold 26' SXS 2010 Part Number W10330404 has been compiled to provide the recent information on design, features, operation, troubleshooting and repair procedures for 26' SXS for 2010.

This Job Aid is not intended to replace or substitute for the Use and Care Guides or Tech Sheets associated with any of the models covered. Refer to the Technical Service sheet shipped with the refrigerator for detailed information for the unit you are servicing.

## GOALS AND OBJECTIVES

The goal of this Job aid is to provide basic information that will enable the service technician to properly diagnose malfunctions and repair 26" SXS refrigerators for 2010.

The objectives of this Job Aid are to:

- Understand and follow proper safety precautions.
- Successfully troubleshoot and diagnose malfunctions.
- Successfully perform necessary repairs.
- Successfully return the refrigerator to its proper operational status.

Specific components and procedures covered in this Job Aid are:

Grille Removal  
Leveling  
Door Alignment  
Door Removal  
Small 6 Cube Ice Maker  
Dispenser  
Thermistors  
Air and Water Filters  
Evaporator Fan  
Defrost Heater  
Defrost Bimetal  
Overload Protector  
Condenser Fan Motor  
Start Module  
Stealth Control

WHIRLPOOL CORPORATION assumes no responsibility for any repairs made on our products by anyone other than authorized In-Home Service Professionals.

# TABLE OF CONTENTS

	Page
<b>GENERAL</b> .....	1-1
Safety .....	1-1
Introduction Specifications and Overview .....	1-2
SxS Model Number Interpretation .....	1-3
6th Sense Technology .....	1-4
<b>INSTALLATION REQUIREMENTS</b> .....	2-1
Installation Instructions .....	2-1, 2-7
<b>REFRIGERATOR COMPONENTS</b> .....	3-1
Disassembling Refrigerator Compartment Components .....	3-1
Disassembling Refrigerator Compartment Components –Water Filter Housing .....	3-3
Refrigerator Thermistor .....	3-4
Accessing Water Reservoir .....	3-6
<b>FREEZER COMPARTMENT AND ICE MAKER</b> .....	4-1
Freezer Components .....	4-1
Checking the Freezer Thermistor .....	4-1
Accessing Freezer Components .....	4-3, 4-4
Evaporator Component Identification .....	4-4
Removing Evaporator Fan Motor .....	4-5
Checking evaporator Fan motor .....	4-6
Checking Defrost Bimetal .....	4-7
Replacing the Defrost Heater .....	4-8
Freezer Door Component Location .....	4-9
Ice maker – Emitter /Receiver Boards .....	4-10
Component Identification .....	4-12
Accessing New In Door Ice Maker .....	4-13
Ice Maker .....	4-15
Modular Ice Maker & Ice Level Detector Service Sheet .....	4-16
Disassembling the Ice Maker .....	4-17
Replacing Auger Motor and Related Components .....	4-19
Removing Auger Motor .....	4-20
Checking the Auger Motor .....	4-21
Removing Emitter and Receiver Boards .....	4-21
Water Tube Routing .....	4-22
<b>DISPENSER AND USER INTERFACE</b> .....	5-1
Programming .....	5-1
Stealth Control .....	5-1
Sleep Mode .....	5-2
Adjusting Temperature Set Points .....	5-4
Adjusting Temperature Settings .....	5-5
Freezer Temperature Setting .....	5-5
Ice Dispenser .....	5-6
Max Ice .....	5-7
Dispenser Light .....	5-8

## TABLE OF CONTENTS (continued)

Door Open Alarm .....	5-9
Dispenser Lock .....	5-10
Cooling Off Mode .....	5-11
Cooling On Mode .....	5-11
Water Filter Status Light .....	5-12
Showroom Mode .....	5-13
Accessing User Interface and Dispenser Components .....	5-14, 5-17
<b>MACHINE COMPARTMENT .....</b>	<b>6-1</b>
Machine Compartment Components .....	6-1
Starting Device Operation .....	6-3
Accessing Dual Water Valve .....	6-4
Condenser Fan .....	6-5
Drain Pan .....	6-6
Front Wheel .....	6-7
Control and Power Supply Boards .....	6-8
<b>DIAGNOSTICS, WIRING DIAGRAMS AND TROUBLESHOOTING .....</b>	<b>7-1</b>
Voltage Test Points .....	7-3
Thermistor Resistance Table .....	7-6
Service Sheet .....	7-7, 7-8
Product Specifications And Warranty Information Sources .....	7-4

# GENERAL

## Safety

Observe all safety warnings and messages.

The Use and Care manual and Installation instructions that come with the product as well as stickers and literature attached to the refrigerator contain safety symbols. These symbols contain messages telling you of potential hazards and explain how to reduce your chance of injury. The message will also tell you what can happen if the instructions are not followed.

### Your safety and the safety of others are very important.

We have provided many important safety messages in this manual and on your appliance. Always read and obey all safety messages.



This is the safety alert symbol.

This symbol alerts you to potential hazards that can kill or hurt you and others.

All safety messages will follow the safety alert symbol and either the word "DANGER" or "WARNING."

These words mean:

**⚠ DANGER**

You can be killed or seriously injured if you don't immediately follow instructions.

**⚠ WARNING**

You can be killed or seriously injured if you don't follow instructions.

All safety messages will tell you what the potential hazard is, tell you how to reduce the chance of injury, and tell you what can happen if the instructions are not followed.

### IMPORTANT SAFETY INSTRUCTIONS

**WARNING:** To reduce the risk of fire, electric shock, or injury when using your refrigerator, follow these basic precautions:

- Plug into a grounded 3 prong outlet.
- Do not remove ground prong.
- Do not use an adapter.
- Do not use an extension cord.
- Disconnect power before servicing.
- Replace all parts and panels before operating.
- Remove doors from your old refrigerator.
- Use nonflammable cleaner.
- Keep flammable materials and vapors, such as gasoline, away from refrigerator.
- Use two or more people to move and install refrigerator.
- Disconnect power before installing ice maker (on ice maker kit ready models only).
- Use a sturdy glass when dispensing ice (on some models).

**SAVE THESE INSTRUCTIONS**

# Introduction Specifications and Overview

## 26' Dimensions

<u>Dimensions</u>	<u>Inches.</u>
Carton Depth	35
Carton Height	71 1/4
Carton Width	38
Cutout Depth (in)	29 13/16
Cutout Height (in)	69 5/16
Cutout Width (in)	36 1/16
Depth	36
Height	69 1/4
Width	35 7/16
Depth Closed Excluding Handles	33 1/2
Depth Closed Including Handles	36
Depth Excluding Doors	29 3/8
Depth With Door Open 90 Degree	50 7/8
Height To Top Of Cabinet	68 5/8
Height To Top Of Door Hinge	68 15/16
Height To Top of Door Trim	69 1/4
Width Doors Open 90 Degrees	37 3/4
Width of Cabinet Only	35 7/16
Width with Doors Closed	35 3/4
Capacity	26.360 C.F.
Gross Weight	298 LBS.



# SXS Model Number Interpretation

1 2 3 4 5 6 7 8 9 10  
**W S 3 0 S 2 E X T**

## 1 Refrigerator Brand

W = Whirlpool    A = Amana    I = Inglis    L = Admiral  
 G = Whirlpool Gold    J = Jenn-Air    R = Roper    P = Performa  
 M = Maytag    K = KitchenAid    C = Magic Chef    T = Estate

## 2 Platform

S = SxS

## 3 Depth/Door

C = Counter Depth    S = Contour Smooth Door    B = Chiseled (Beveled)  
 F = Flat Smooth Door    T = Textured on colored models  
 O = Overlay    K = Trim Kit (Visible pieces of Trim)

## 4 Capacity

## 5 Ice Maker

C = Ice in Cabinet (IDi)  
 N = Non Dispense  
 E = External Dispense no UI  
 S = Shaved Ice  
 W = Internal Water  
 L = IDi with LCD Graphics  
 R = Right Sized Ice  
 D = Dispenses I&W (non IDi)

## 6 Feature Pack

2 - Basic  
 4 - Medium  
 6 - Premium  
 8 - Super Premium  
 5 = Lowes  
 3 = Contract

## 7 Feature Pack/Energy<sup>9</sup> Year of Launch

E = 2008 E-Star Qualified (20%)  
 R = E-Star 25%  
 X = E-Star 30%  
 S = E-Star 35+  
 J = E-Star 45+  
 M = Meets Energy Standards

V = 2008  
 W = 2009  
 X = 2010  
 Y = 2011  
 A = 2012

**10 Color**  
 B = Black    A = Monochromatic Satina  
 L = Satina    Y = Monochromatic SS  
 S = Stainless    E = Dry Erase (AMA)  
 D = Silver    H = Red (AMA)  
 K = SS Cab    N = Twilight (AMA)

# Introduction Specifications and Overview (continued)

## 6<sup>th</sup> Sense Technology

6<sup>th</sup> Sense software makes an estimation of the actual food temperature inside the refrigerator and freezer compartment and adjusts cooling to allow the food packages to return their initial temperature faster during pull down, door openings, or heavy food load. 6<sup>th</sup> Sense algorithm runs in both freezer compartment and refrigerator compartment and each contains 3 routines: Trigger, Package Estimator, and Defrost Manager.



Trigger routine is executed every 2.5 seconds while Package Estimator and Defrost Manager are executed every 10 seconds. The trigger routine is divided into two subroutines: door monitoring and temperature monitoring. Trigger parameters and performance parameters reside in the User Interface board, the actual 6<sup>th</sup> sense algorithm resides in Gemini Flash board.

Package Estimator routine computes an estimation of food in FC and RC according to Thermistor reading and door status. Package estimator is run when the User Interface sends the required parameters to Gemini flash and sets the 6<sup>th</sup> Sense Enable bit to true. If 6<sup>th</sup> Sense is needed, it will call for additional cooling by turning on compressor, damper and evaporator fan.

Defrost manager is composed of two main states: Normal and 6<sup>th</sup> Sense. When 6<sup>th</sup> Sense routine is active, defrost will be inhibited based on the control parameters settings to allow food temperature recovery.



# INSTALLATION REQUIREMENTS

## Installation Instructions

This new SXS platform requires different installation steps and adjustments than current SXS refrigerators. Review the Use and Care manual and instruction sheets shipped with the product prior to installation. See the following examples:

### Door Removal, Leveling and Alignment

Gather the required tools and parts and read all instructions before starting installation. Save these instructions for future reference.

**NOTE:** Before moving your product into your home, measure the doorway of your home to see whether you need to remove the refrigerator and freezer doors. If door removal is necessary, see the instructions below.

**IMPORTANT:** Before you begin, turn the refrigerator control OFF. Unplug refrigerator or disconnect power.

**TOOLS NEEDED:**

Phillips screwdriver,  $\frac{3}{16}$ " Allen wrench,  $\frac{1}{4}$ " hex-head socket wrench,  $\frac{1}{4}$ " and  $\frac{5}{16}$ " open-ended wrenches or adjustable wrench



## WARNING

### Electrical Shock Hazard

Disconnect power before removing doors.  
Failure to do so can result in death or electrical shock.

#### 4 Top Left Hinge



A. Do Not Remove Screws

#### 5 Door Removal



#### 6 Top Right Hinge



A. Do Not Remove Screws

#### 3 Wiring Connection

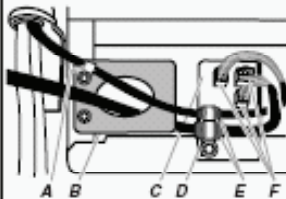

- A. P-clamp
- B. Routing Plate
- C. Electrical Housing
- D. Wiring Clip
- E. Grommets
- F. Wiring Plugs

#### 7 Bottom Hinge

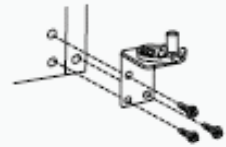

#### 8 Leveling



- A. Bottom Hinge
- B. Leveler Bracket
- C. Leveling Foot

#### 2 Water Dispenser Tubing Connection

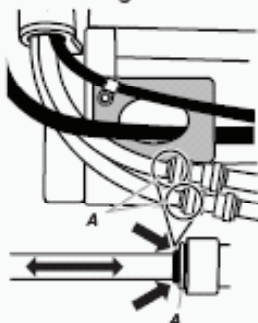

A. Face of Fitting

#### 1 Base Grille

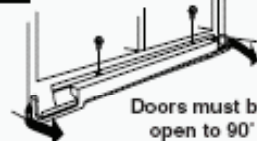

#### 9 Door Alignment

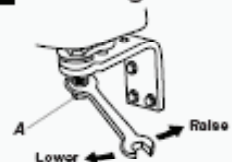

A. Alignment Screw

# Installation Instructions (continued)

## Installation - Example

### Remove the Doors

#### **WARNING**



#### Electrical Shock Hazard

Disconnect power before removing doors.  
Failure to do so can result in death or electrical shock.

1. Unplug refrigerator or disconnect power.
2. Open both doors to 90°. Remove the base grille by removing the two screws, then pulling out on the outside corners. See Graphic 1.  
**NOTE:** The doors must only be opened to 90°. If they are opened all the way, the base grille will not come off.
3. Remove food, the ice storage bin, and any adjustable door or utility bins from doors.
4. Disconnect the water tubing, located behind the base grille on the freezer door side. See Graphic 2.
  - Press the colored outer ring against the face of fitting and pull the water tubing free.  
**NOTE:** Keep the water tubing connector attached to the tube that runs underneath the freezer. The door cannot be removed if the connector is still attached to the tube that runs through the door hinge.
5. Disconnect the wiring, located behind the base grille on the freezer door side. See Graphic 3.
  - Remove the P-clamp using a 1/4" hex-head socket wrench. Remove the small wiring bundle from the P-clamp.
  - Remove the wiring clip using a 1/4" hex-head socket wrench.
  - Pull the electrical housing out from under the refrigerator. Disconnect the wiring plugs from the housing.
  - Gently pull the large wiring bundle (with two white plugs) through the routing plate.
6. Close both doors and keep them closed until you are ready to lift them free from the cabinet.

7. Use a 3/16" Allen wrench to remove the top left hinge screws as shown. See Graphic 4.

**IMPORTANT:** Do not remove either screw A.

#### **WARNING**

#### Excessive Weight Hazard

Use two or more people to lift the freezer door.  
Failure to do so can result in back or other injury.

8. Lift freezer door straight up off bottom hinge. See Graphic 5. The water tubing and wiring remain attached to the freezer door and pull through the bottom left hinge.  
**NOTE:** This may require two people - one to lift the door and another to feed the water tubing and wiring through the hinge. Be sure the hole in the hinge is clear of obstructions, then gently pull one water tube through the hinge. (Avoid kinking the tube.) Next, gently pull the other water tube through the hinge, again avoiding kinks. Finally, gently pull the wiring bundle (including the grommet and wiring plugs) through the hinge.  
**IMPORTANT:** Rest the door on its side on a soft, clean surface, such as a towel, blanket or piece of cardboard. This will help avoid damaging the door, water tubing and wiring.
9. Use a 3/16" Allen wrench to remove the top right hinge screws as shown. See Graphic 6.  
**IMPORTANT:** Do not remove either screw A.
10. Lift the refrigerator door straight up off bottom hinge.
11. It may not be necessary to remove the bottom hinges to move the refrigerator through a doorway. Both bottom hinges have similar construction.
  - If necessary, disassemble the hinges. See Graphic 7.  
**IMPORTANT:** The leveler brackets are mounted behind the hinges. If you remove the hinges, make sure that the leveler brackets are replaced when reinstalling the hinges.

### Replace the Doors and Hinges

1. Replace both bottom hinges, if removed. Make sure that the leveler brackets are assembled behind the hinges. Tighten screws.  
**IMPORTANT:** When the screws are tightened properly, there should not be any gaps between the refrigerator, leveler bracket and hinge.

# Installation Instructions (continued)

## Installation - Example (continued)

**NOTE:** There are two wiring bundles that run underneath the freezer - a large bundle with a large grommet and two white plugs at the end, and a small bundle with a small grommet and one yellow plug at the end.

### **⚠ WARNING**

#### **Excessive Weight Hazard**

**Use two or more people to lift the freezer door.  
Failure to do so can result in back or other injury.**

- Before replacing the freezer door on the bottom left hinge, feed the small wiring bundle through the hinge. Assistance may be needed.  
**IMPORTANT:** Do not feed the large wiring bundle through the hinge. This bundle is intended to run directly from the door to the connections beneath the freezer. Forcing the large bundle through the hinge may damage the door and/or the wiring, and will keep the door from closing properly.
- Feed both water tubes through the bottom left hinge, then replace the freezer door on the hinge. Assistance may be needed.  
**NOTE:** Provide additional support for the doors while the top hinges are being replaced. Do not depend on the door magnets to hold the doors in place while you are working.
- Align and replace the top left hinge as shown. See Graphic 4. Tighten screws.
- Reconnect water tubing and wiring.  
**IMPORTANT:** Do not intertwine the water tubing and wiring bundles when reconnecting them.
  - Push the larger  $\frac{5}{16}$ " (7.94 mm) water tube into the blue fitting until it stops, then push the smaller  $\frac{1}{4}$ " (6.35 mm) water tube into the green fitting until it stops. See Graphic 2.
  - Reinstall the P-clamp around the small wiring bundle (with one yellow plug), then replace the P-clamp on the top screw hole of the routing plate. See Graphic 3.
  - Gently route the large wiring bundle (with two white plugs) through the hole in the routing plate, so that the wiring runs behind the right side of the routing plate. See Graphic 3.**NOTE:** The large wiring bundle should always remain below the small wiring bundle.
  - Reconnect the wiring plugs to the electrical housing, then push the housing back under the refrigerator. Align the left hole in the front lip of the housing with the right hole in the refrigerator's base crossbar. See Graphic 3.
  - Reinstall the wiring clip over the grommets. First install the smaller grommet into the top of the clip, then install the larger grommet into the bottom of the clip (closest to the screw hole). See Graphic 3.
  - Align the clip's screw hole with the left hole in the electrical housing and the right hole in the crossbar, and screw in the clip using a single screw. Tighten screw. See Graphic 3.**IMPORTANT:** Once connected, the wiring bundles should not be taut. Some flexibility is needed to allow the freezer door to open properly.
- Replace the refrigerator door by lifting the door onto the bottom right hinge.
- Align and replace the top right hinge as shown. See Graphic 6. Tighten screws.
- Replace the ice storage bin and any adjustable door or utility bins.

- Plug refrigerator into a grounded 3 prong outlet.

### **Leveling and Door Closing**

Your refrigerator has two adjustable front feet — one on the right and one on the left. In most cases, the refrigerator should be steady when both feet are touching the floor. If your refrigerator seems unsteady or if you want the doors to close more easily, adjust the refrigerator's tilt using the instructions below:

- Move the refrigerator into its final location. If necessary, open both doors to 90° and remove the base grille. See Graphic 1.
- The two leveling feet are located on the brackets on each side of the product. See Graphic 8.

**NOTE:** Having someone push against the top of the refrigerator takes some weight off the leveling feet. This makes it easier to make adjustments.

- Use a  $\frac{1}{4}$ " open-ended or adjustable wrench to adjust the leveling feet. Turn the leveling foot to the left to raise that side of the product, or turn it to the right to lower that side of the product.
- Open both doors again and check that they close as easily as you like. If not, tilt the refrigerator slightly more to the rear by turning the leveling feet to the left. It may take several more turns, and you should turn both leveling feet the same amount.

**NOTE:** Whenever you need to move the refrigerator, turn the leveling feet to the right until they are no longer touching the ground. This will allow the refrigerator to roll more easily.

### **Door Alignment**

A refrigerator that is not level from side-to-side may appear to have doors that are not properly aligned. If the doors appear this way, use the instructions in the previous section to check the leveling.

The doors are designed to be slightly different heights when the refrigerator is empty, in order to account for the weight of food that will be placed on the doors. If the doors are still not aligned after checking the leveling and loading the refrigerator with food, follow the steps below to adjust the door alignment.

- If necessary, open both doors to 90° and remove the base grille. See Graphic 1.
- Locate the alignment screw on the bottom hinge of the refrigerator door. See Graphic 9.
- Use a  $\frac{5}{16}$ " open-ended or adjustable wrench to turn the screw. To raise the refrigerator door, turn the screw to the right. To lower the door, turn the screw to the left.
- Check that the doors are even at the top. If necessary, continue to turn the alignment screw until the doors are aligned.
- Open both doors to 90°. Replace the base grille. See Graphic 1.

## Installation

Refrigerators are shipped with the handles packed in the refrigerator door.

1. Remove the handles from the door and unwrap.



2. The instruction sheet and a Hex key tool are attached to the handle. Review the instruction sheet.

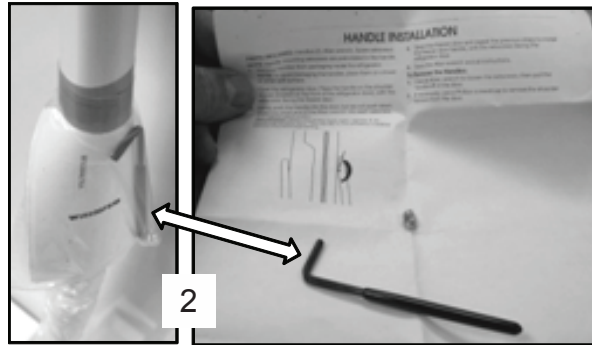

3. Install the handle on the mounting studs with the hex screws facing to the center.

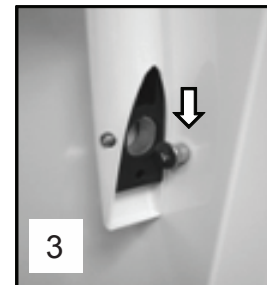

4. Hold the handle tight against the door as you tighten the screws. The handle will pull in tight against the door as the screw is tightened.

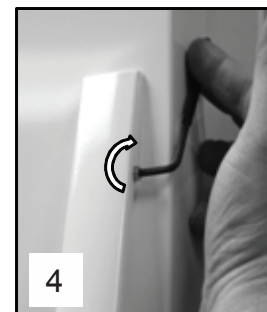

# Installation Instructions (continued)

## Installation (continued)

### Removing Grille

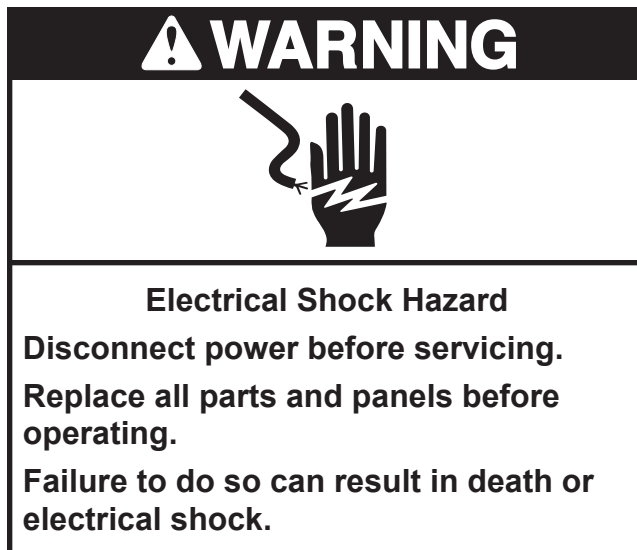

1. Disconnect power to the refrigerator.

The grille is held in place with 2 ¼" screws.

2. Remove screws

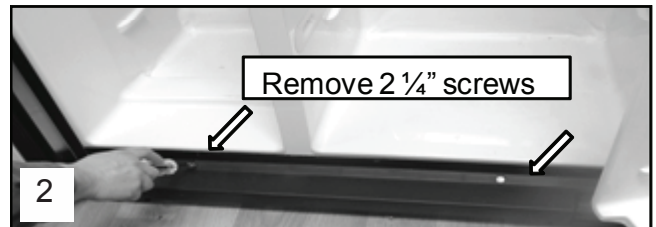

3. Open the doors 90 degrees perpendicular to the cabinet to remove the grille.

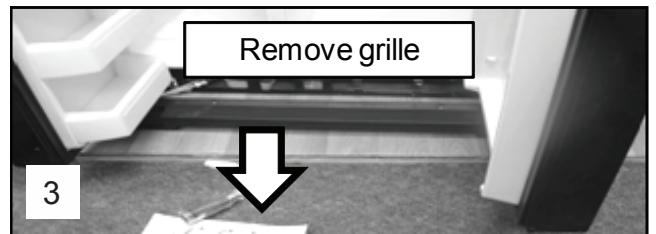

### Components Located Behind Grille

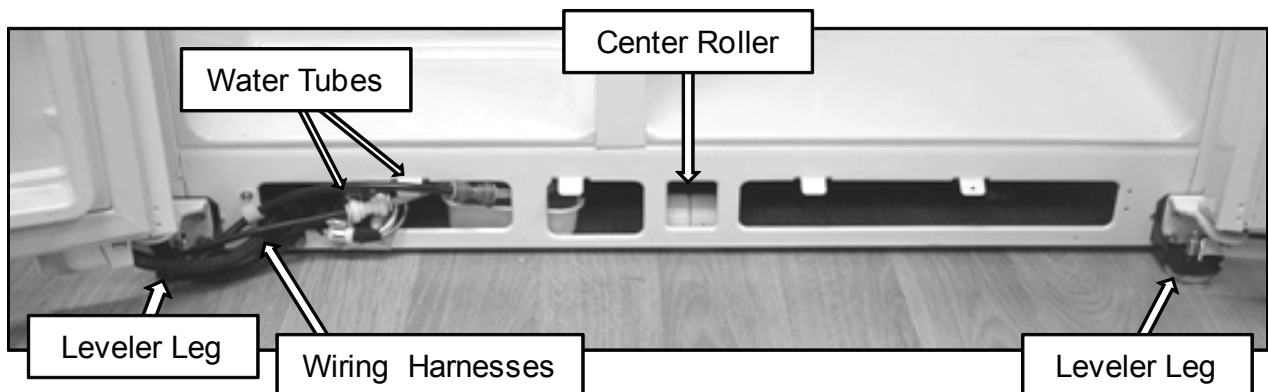

# Installation Instructions (continued)

## Removing Freezer Door

### **⚠ WARNING**



#### **Electrical Shock Hazard**

**Disconnect power before servicing.**

**Replace all parts and panels before operating.**

**Failure to do so can result in death or electrical shock.**

1. Unplug or disconnect the refrigerator from the power supply.
2. Remove the screws securing the wire harnesses to the cabinet.
3. Disconnect water tubes from the door side of the connector.

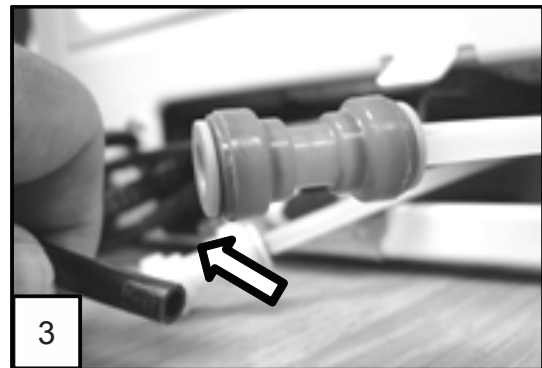
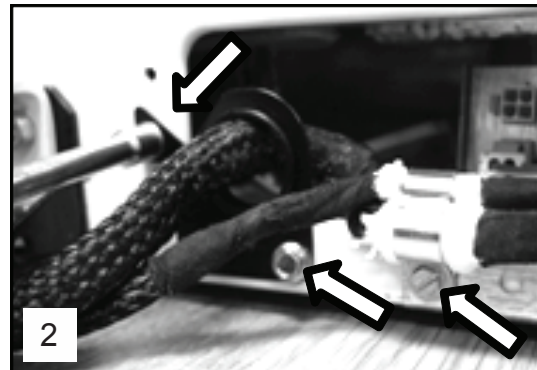

4. Unplug the three wire harnesses plugged into the terminal board.

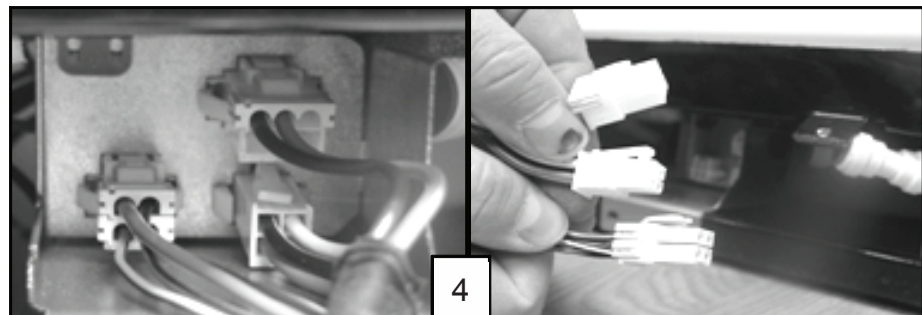

5. Remove strain relief from the wire harness. This will allow the harness to pass through the hole in the hinge.



## Installation Instructions (continued)

### Removing Freezer Door Upper Hinge

6. Remove Two 3/16" hex key screws (A).  
Do not remove or loosen the other two screws (B).

7. Keep the door closed and lift off the hinge.

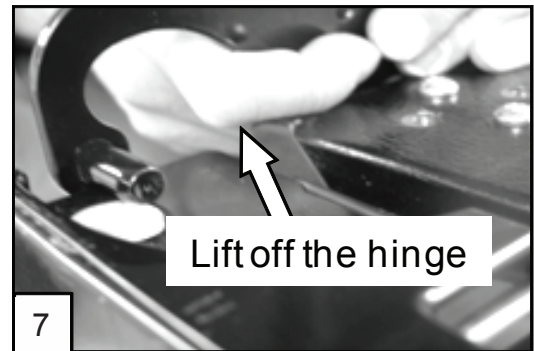
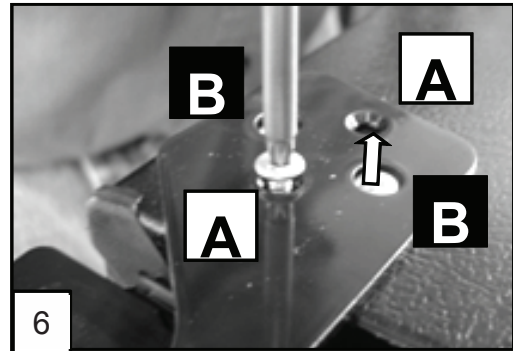

### **⚠ WARNING**

#### **Excessive Weight Hazard**

**Use two or more people to lift the freezer door.**

**Failure to do so can result in back or other injury.**

8. Have another person open the freezer door and lift up slowly.



9. As the door is lifted guide the wiring harnesses and water tubes through the hinge.



10. Lift the door straight up to prevent damage and kinking of the water tube.

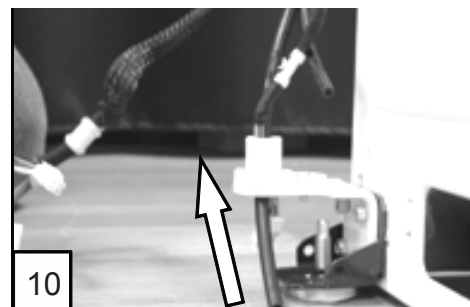

**Note:** When assembling, always use 2 people and make sure not to crimp the water tubes when installing through the hinge hole.

**—NOTES—**



# REFRIGERATOR COMPONENTS

## Refrigerator Compartment

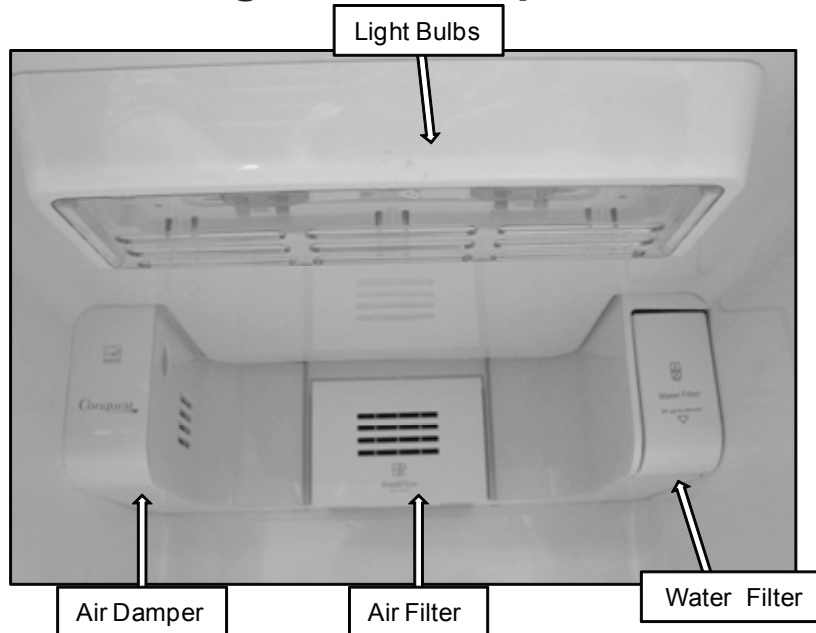

### Disassembling Refrigerator Compartment Components

**⚠ WARNING**

**Electrical Shock Hazard**  
Disconnect power before servicing.  
Replace all parts and panels before operating.  
Failure to do so can result in death or electrical shock.

1. Disconnect power to the refrigerator.
2. Open the water filter door and remove the filter.
3. Open the air filter door and remove the filter.
4. Remove the ¼" screw securing the air damper cover to the cabinet.

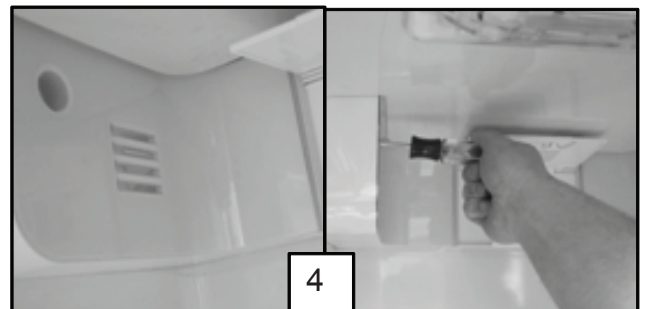
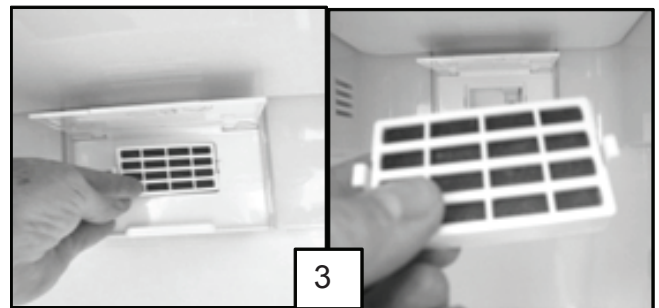
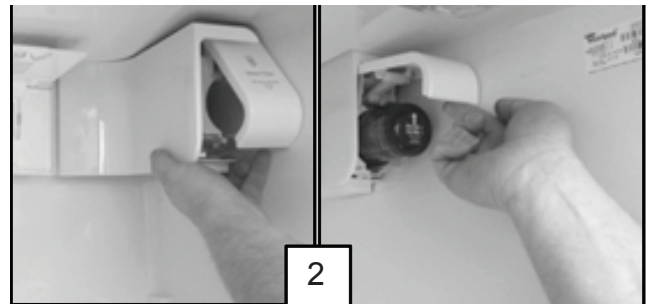

## Refrigerator Compartment (continued)

5. Remove the air damper cover.

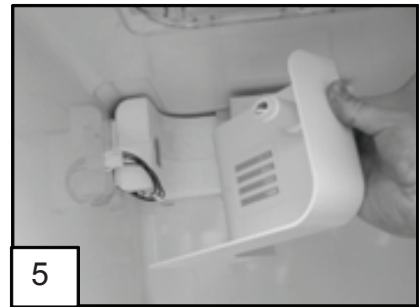

6. Remove the 1/4" screw securing the air filter housing to the cabinet and remove.



7. Disconnect the wiring harness and remove the air damper assembly.

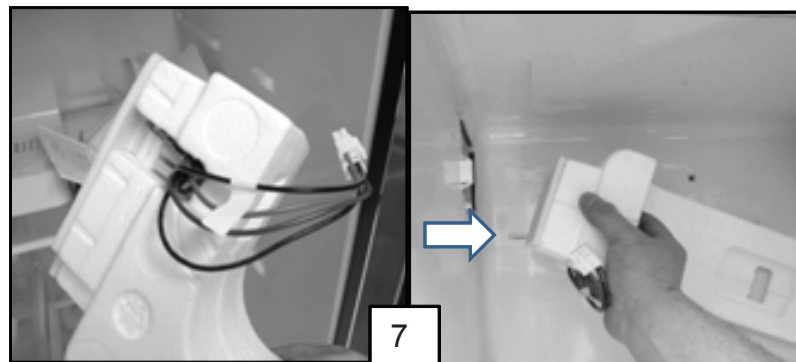

8. Check the seal around the damper housing for any damage or misplacement. Replace or reposition seal as needed.



## Refrigerator Compartment (continued)

### Disassembling Refrigerator Compartment Components – Water Filter Housing

Remove the water filter as explained earlier.

1. Remove the ¼” screw securing the filter cover to the filter body.



2. Remove the cover.



3. Remove the ¼” screw securing the filter body to the cabinet wall.



4. To replace the filter housing, disconnect the water tubes in the back of the refrigerator and remove Permagum seal. Pull the filter housing and water tubes through the opening in the cabinet and replace.



# Refrigerator Compartment (continued)

## Refrigerator Thermistor

The refrigerator Thermistor is a variable resistance device connected to the control board. The temperature of the refrigerator compartment causes the resistance of the Thermistor to change. The resistance is monitored by a circuit on the control board which controls the operation of the cooling system. The Thermistor is located on the right side of the refrigerator cabinet attached to the back of the cover labeled 6<sup>th</sup> sense.

## Refrigerator Thermistor

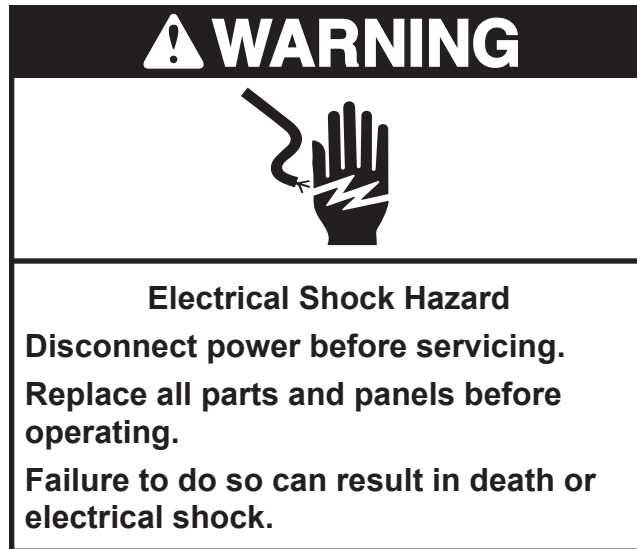

1. Disconnect power to the refrigerator.
2. Disconnect the wiring harness from connector P6 on the control board.
3. Connect an Ohmmeter across the Orange and Blue/White wires in the disconnected wiring harness and measure the resistance.
4. Compare the resistance measured to the value listed on the tech sheet shipped with the refrigerator. Replace Thermistor if needed.

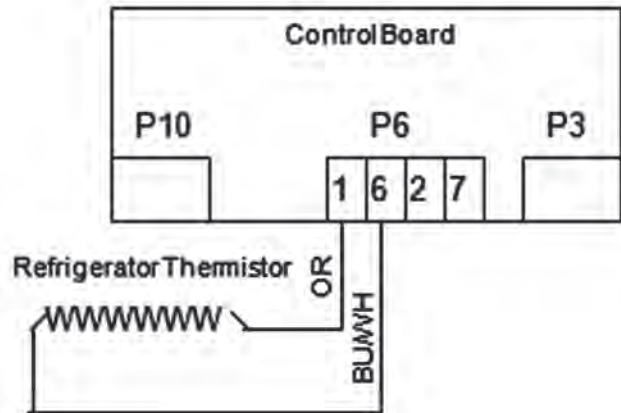

## Refrigerator Compartment (continued)

### Replacing Refrigerator Thermistor

1. Depress the tabs on either end of the Thermistor cover and remove.
2. To replace the Thermistor order replacement Thermistor kit through the normal part ordering system by model number. Follow the instructions supplied with the kit.

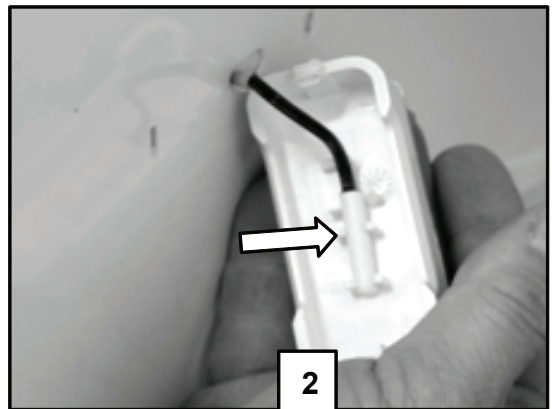
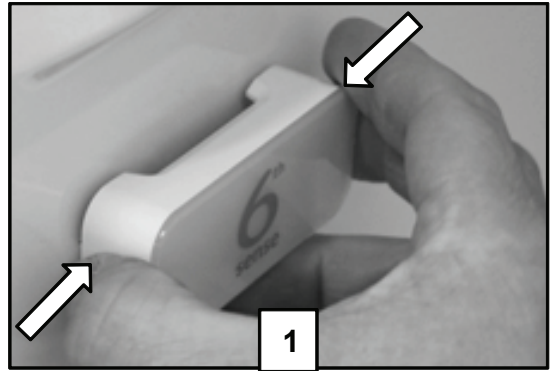

# Refrigerator Compartment (continued)

## Disassembling Refrigerator Compartment Components – Accessing Water Reservoir

### Disassembling Refrigerator Compartment Components – Accessing Water Reservoir

1. The light bulb cover is very flexible and can be bent to release the 4 tabs that extend into the cabinet wall and remove.

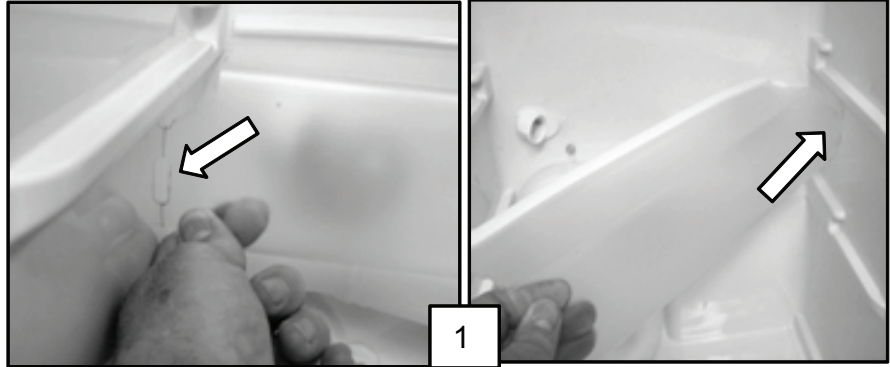

2. To replace the water reservoir, Shut off water supply.

3. Remove the 1/4" hex head screw and the wire ties securing the reservoir to the cabinet.

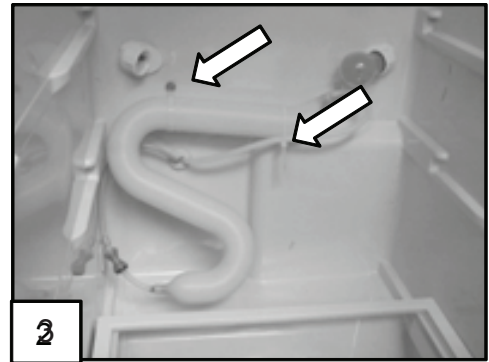

4. Disconnect the water tube connected to the dual water valve located in the machine compartment and disconnect the water tube fitting on the lower left hand corner of the reservoir. Pull out the water reservoir and the water tube routed through the opening in the cabinet. Replace the reservoir.

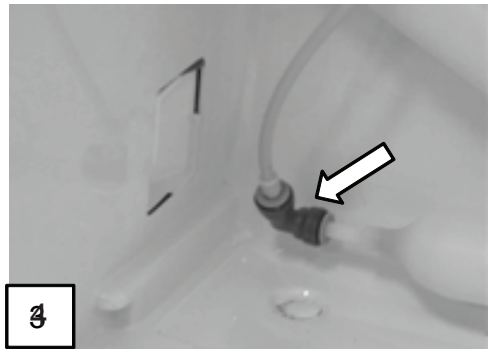

A vacuum relief is located below the water reservoir. The purpose of the relief is to allow pressure to equalize between the inside and outside of the refrigerator.

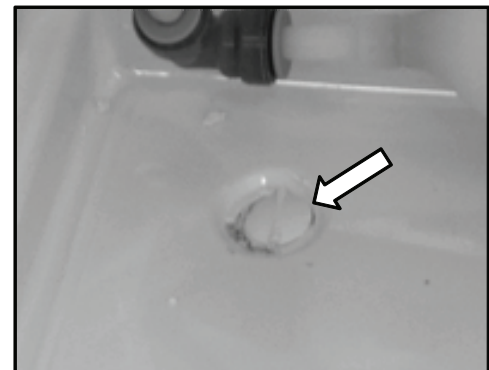

# FREEZER COMPARTMENT AND ICE MAKER

## Freezer Components

### Freezer Thermistor

The freezer Thermistor is a variable resistance device connected to the control board. The temperature of the freezer compartment causes the resistance of the Thermistor to change. The resistance is monitored by a circuit on the control board which controls the operation of the cooling system. The Thermistor is located on the left side of the freezer cabinet attached to the back of the cover labeled 6<sup>th</sup> sense.

### Checking the freezer Thermistor

⚠ **WARNING**



**Electrical Shock Hazard**

**Disconnect power before servicing.**

**Replace all parts and panels before operating.**

**Failure to do so can result in death or electrical shock.**

1. Disconnect power to the refrigerator
2. Disconnect the wiring harness from connector P6 on the control board.
3. Connect an Ohmmeter across the 2 Black wires in the disconnected wiring harness and measure the resistance.
4. Compare the resistance measured to the value listed on the tech sheet shipped with the refrigerator. Replace Thermistor if needed.

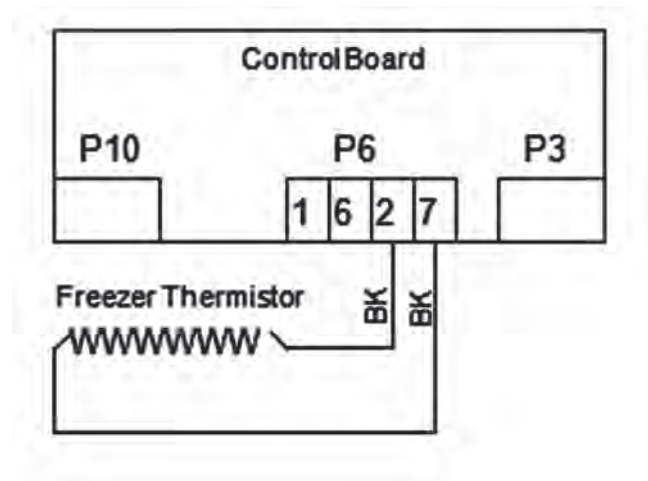

Temp F	Resistance
-10	31402
-5	26704
0	22774
5	19476
10	16701
15	14359
20	12378
25	10698
30	9268
40	7007
45	6115

Temp F	Resistance
50	5348
55	4687
60	4117
65	3624
70	3197
75	2826
80	2503
85	2221
90	1974
95	1758
100	1569

## Freezer Components (continued)

### Replacing Freezer Thermistor

1. Depress the tabs on either end of the Thermistor cover and remove.
2. To replace the Thermistor order replacement Thermistor kit through the normal part ordering system by model number. Follow the instructions supplied with the kit.

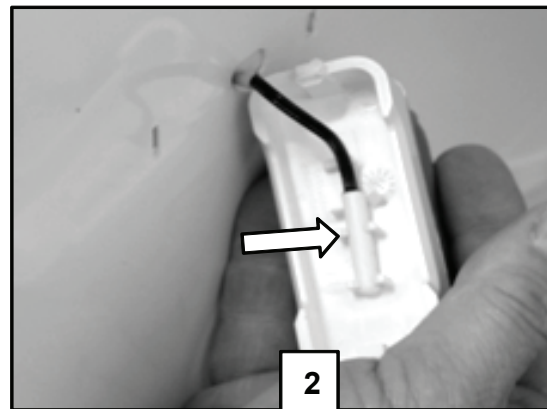
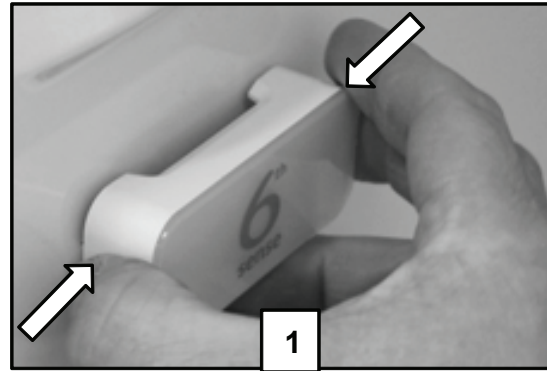



## Freezer Components (continued)

### Accessing Freezer Components

#### **⚠ WARNING**



**Electrical Shock Hazard**  
**Disconnect power before servicing.**  
**Replace all parts and panels before operating.**  
**Failure to do so can result in death or electrical shock.**

1. Unplug refrigerator or disconnect power. Remove food and shelving.
2. Pull off the light cover located in the top left hand corner of the freezer compartment.
3. Remove the 1/4" hex head screw below the light bulb.
4. Pull the top of the air duct cover out at the top and lift up to remove.

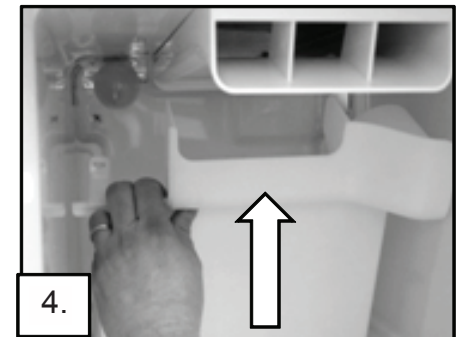
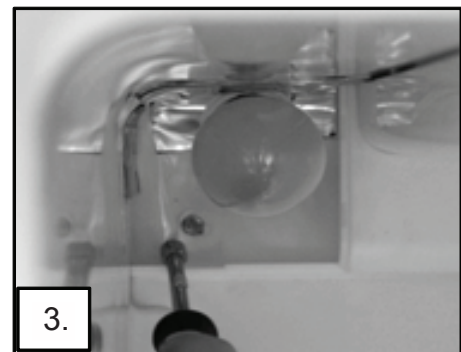
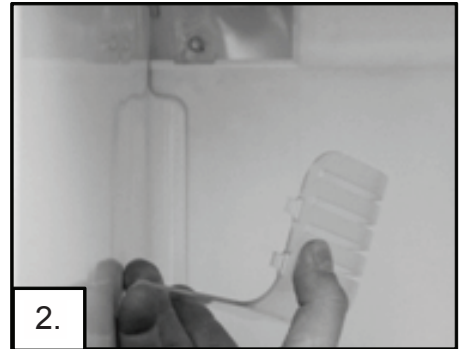

5. The bottom of the duct has 2 slots that slid onto the top of the evaporator cover.

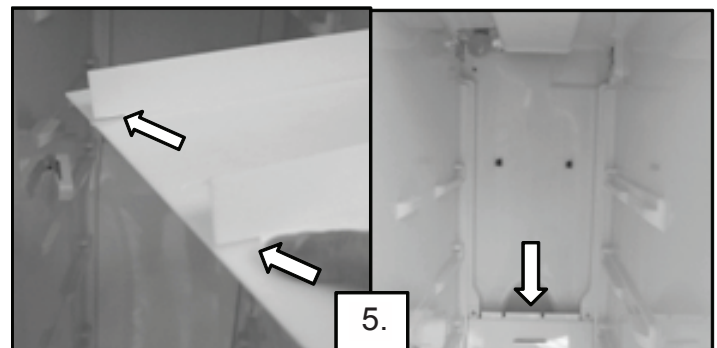

# Freezer Components (continued)

## Accessing Freezer Components (continued)

5. Remove the 4 - 1/4" hex head screws securing the evaporator to the cabinet.



6. Pull out the evaporator cover.



## Evaporator Component Identification

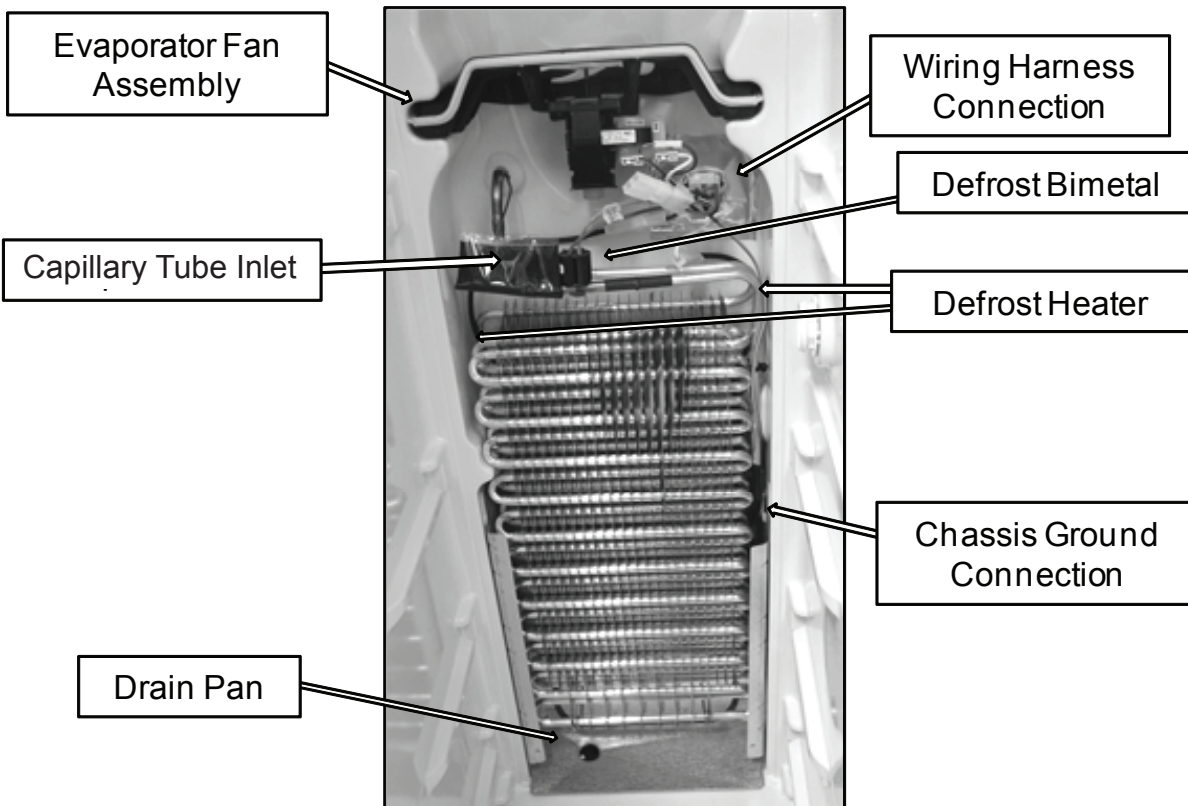

## Freezer Components (continued)

### Removing Evaporator Fan Motor

1. Slide out the evaporator fan motor assembly from the built in cabinet rails and disconnect the wiring harness.

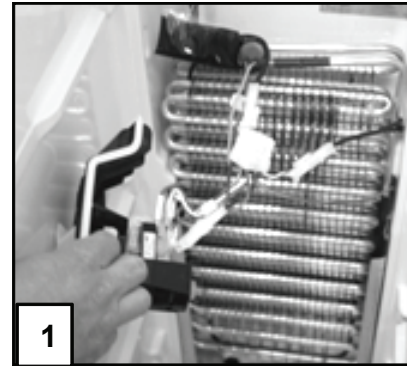

2. To change the fan blade, pull the blade off the shaft and replace. When installing the blade, push the blade down on the shaft until it bottoms out.



3. Unclip the mounting bracket from the fan shroud to remove the motor.

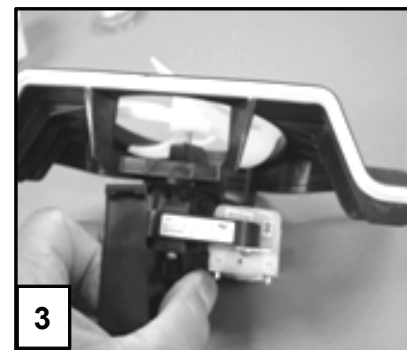

## Freezer Components (continued)

### Checking evaporator fan motor

<b>⚠ WARNING</b>

<b>Electrical Shock Hazard</b> <b>Disconnect power before servicing.</b> <b>Replace all parts and panels before operating.</b> <b>Failure to do so can result in death or electrical shock.</b>

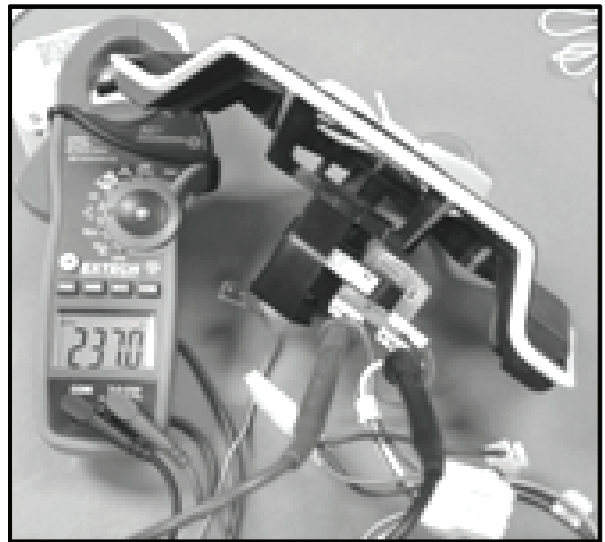
Unplug refrigerator or disconnect power. The evaporator fan motor is a 120 VAC shaded pole motor. To check, remove the 2 wires from the motor. Connect an Ohmmeter across the motor leads. The resistance measured should be approximately 135 Ohms plus or minus 10%. Note: the motor assembly does not have to be removed from the freezer to make this check.



## Freezer Components (continued)

### Checking Defrost Bimetal

**⚠ WARNING**



**Electrical Shock Hazard**  
**Disconnect power before servicing.**  
**Replace all parts and panels before operating.**  
**Failure to do so can result in death or electrical shock.**

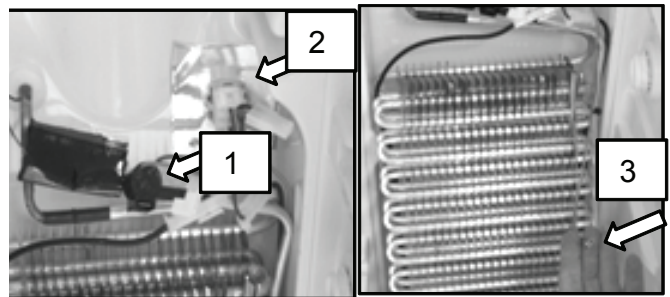

Disconnect power to the refrigerator.

1. Slide the defrost bimetal off the coil.
2. Disconnect the wiring harness.
3. Disconnect the green chassis ground wire attached to the evaporator heat shield.
4. Connect an Ohmmeter across the Bimetal wires inserted into the wiring harness connector. If the bimetal is warm the meter should indicate an open circuit. If the Bimetal is at normal freezer temperature -5 to +5 degrees F, the meter should measure less than 1 OHM of resistance indicating a closed circuit.



### Checking Defrost Heater

Disconnect power to the refrigerator.

1. Disconnect the two black wires attached to the defrost heater.
2. Connect an Ohmmeter across the heater. In this example the resistance measured is 31.6 OHMS.

**Note:** Refer to the tech sheet for the refrigerator being tested for the resistance of the heater.

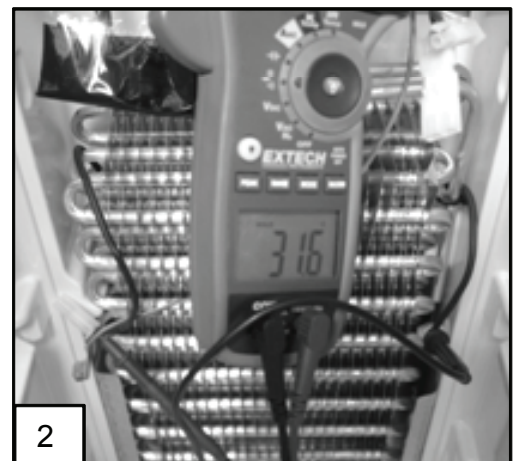

## Freezer Components (continued)

### Replacing the defrost heater

Disconnect power to the refrigerator.

1. Remove evaporator cover as explained earlier.
2. Disconnect the two black wires connected to the defrost heater.
3. Disconnect the green chassis ground wire attached to the evaporator heat shield.
4. Grasp the bottom of the heat shield all pull out. The heat shield is fastened to the cabinet with clips and will pull out easily.
5. Inspect the heat shield and reposition any clips that might have been dislodged during removal.
6. Pull out the defrost heater from the bottom of the evaporator and replace.

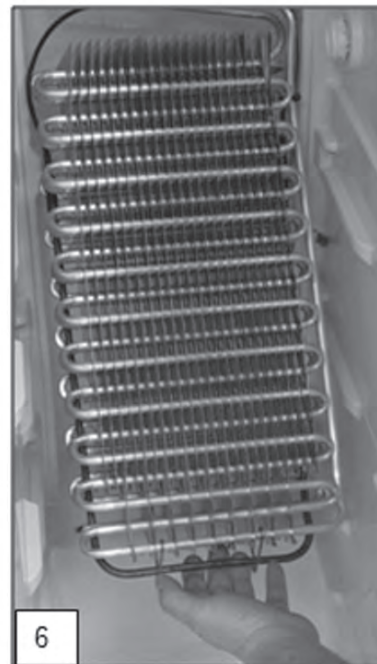
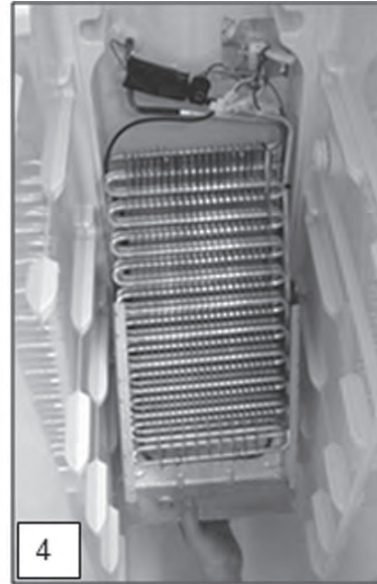

## Freezer Components (continued)

### Freezer Door Component Location

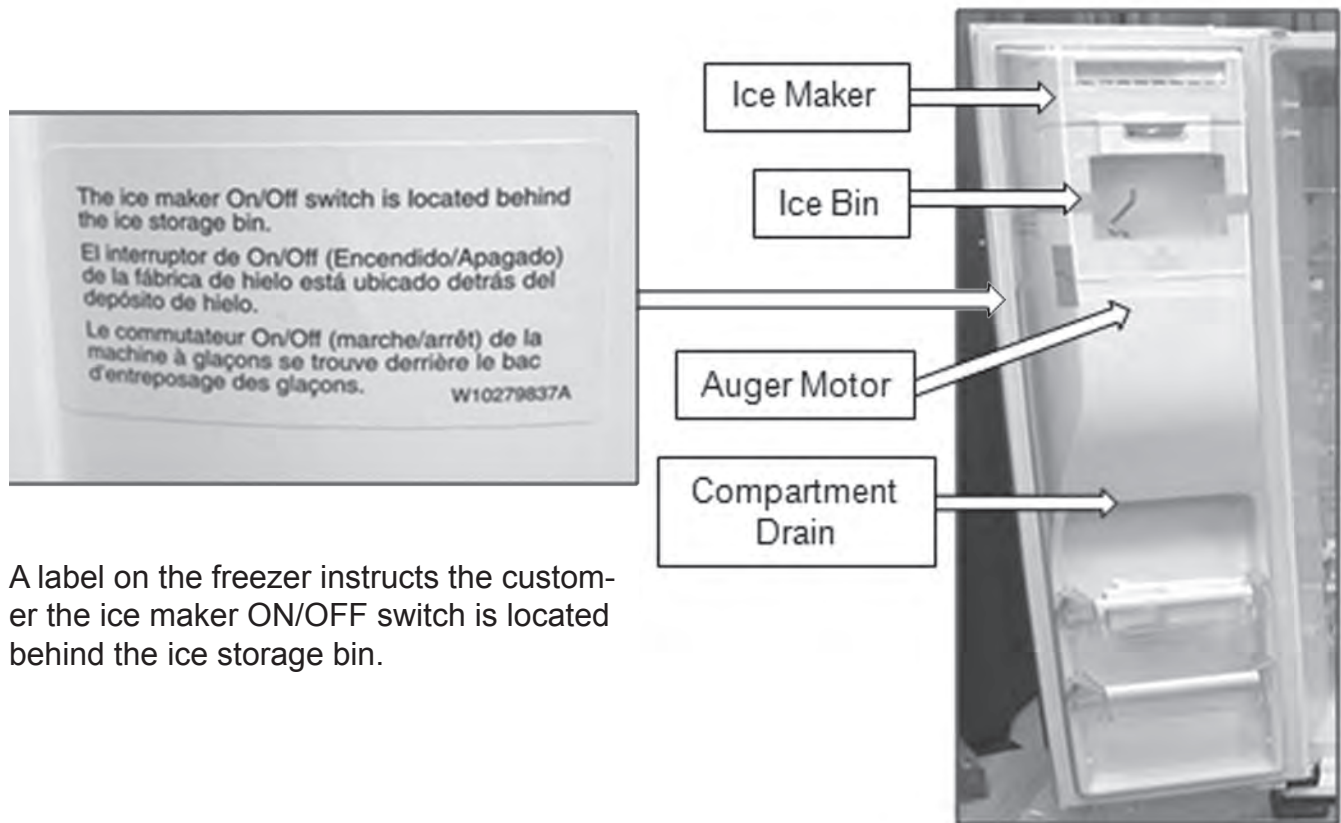

A label on the freezer instructs the customer the ice maker ON/OFF switch is located behind the ice storage bin.

### Ice maker

#### Ice maker Specifications

- IDI XXL design uses W10122576 120VAC ice maker
- 6 cavity small cube ice maker (similar to Tempest ice maker, but mounts in freezer door and has splash provisions)
- Fill volume: 49cc
- Harvest frequency: 42 minutes normally, 35 minutes Accelerice
- Ice bin capacity 4.0 lbs.
- 35 harvests to fill ice bin – about 24 hrs.
- Non-IDI XXL design uses current production ice maker W10122556.
- The module is still the Molex module that we use on nearly every ice maker in the field.

## Freezer Components (continued)

### Ice maker – Emitter /Receiver Boards

The emitter board emits an infrared beam. When the eye on the receiver board sees the beam a circuit is completed indicating the ice bin is in place and not full. This signal is sent to the control board and the ice maker is energized. If the beam is not seen by the receiver board, the control board shuts off the ice maker.

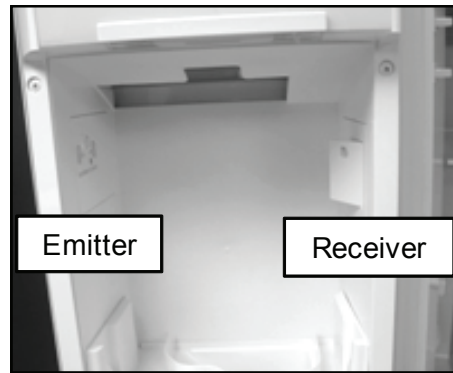

1. With the switch on the emitter board in the ON position, the window covering the emitter beam is opened.

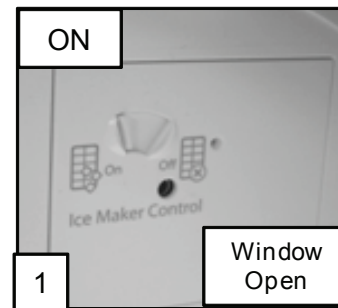

2. With the switch on the emitter board in the OFF position, the window covering the emitter beam is closed.

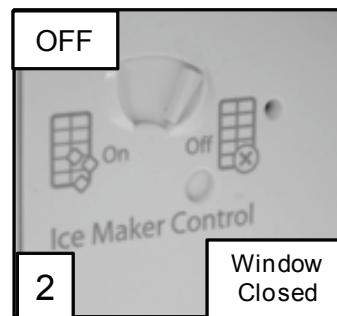

3. With the ice bin installed it forces the receiver door closed aligning a window in the door with the eye on the receiver board.

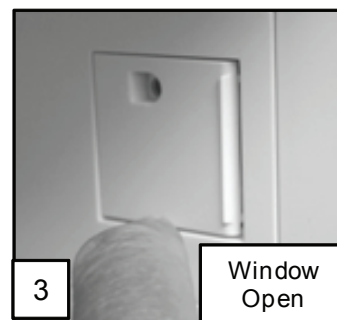

4. When the ice bin is removed, the door opens and blocks the signal from the emitter.

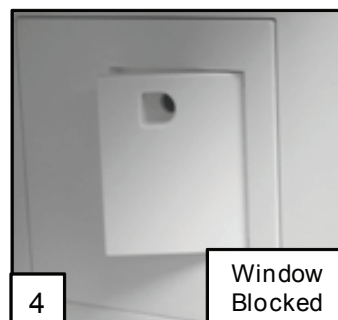



## Freezer Components (continued)

**⚠ WARNING**



**Electrical Shock Hazard**  
**Disconnect power before servicing.**  
**Replace all parts and panels before operating.**  
**Failure to do so can result in death or electrical shock.**

1. Disconnect power to the refrigerator.
2. Depress the ice bin latch and remove the ice bin.

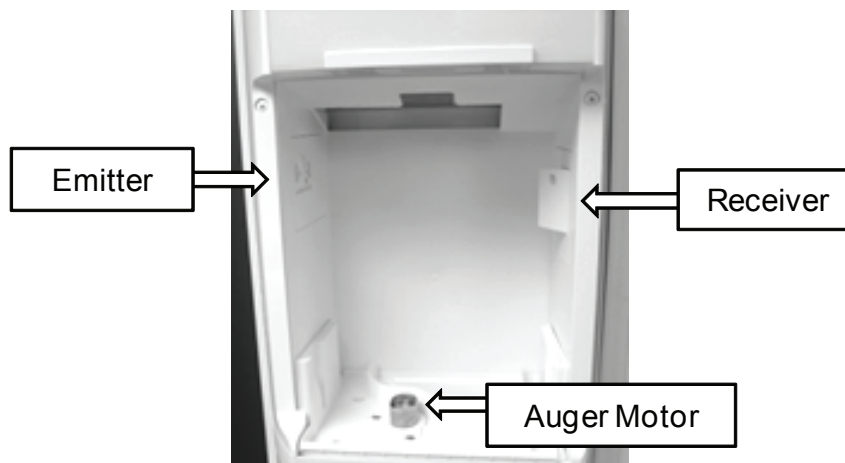
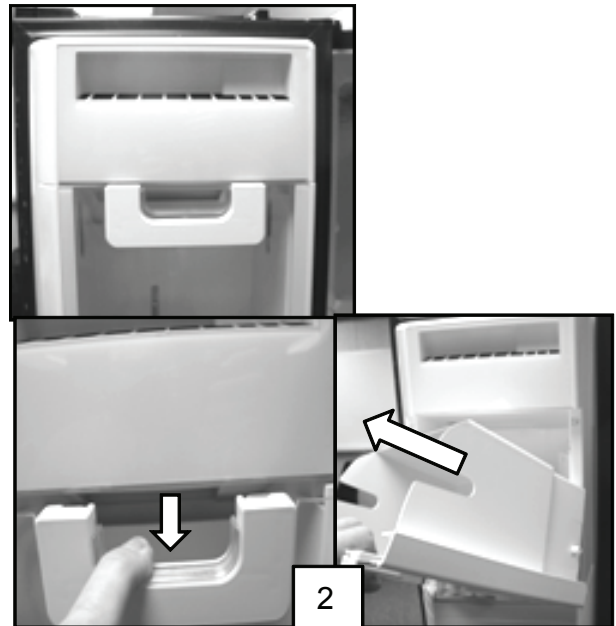

## Freezer Components (continued)

3. Remove 2 - 1/4" screws securing the housing to the inner door panel. Lift the housing up and out to remove.

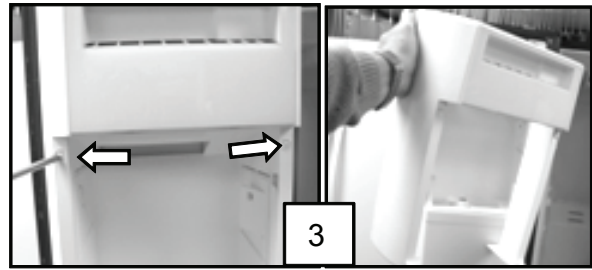

4. When assembling insert the tabs located on the top of the housing into the slots on the inner door panel.

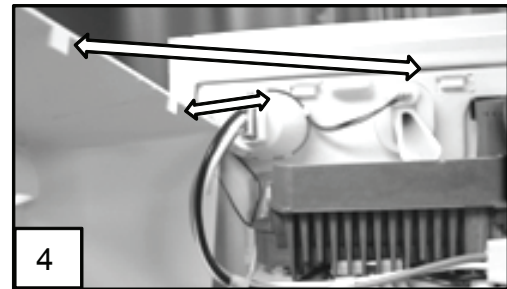

## Component Identification

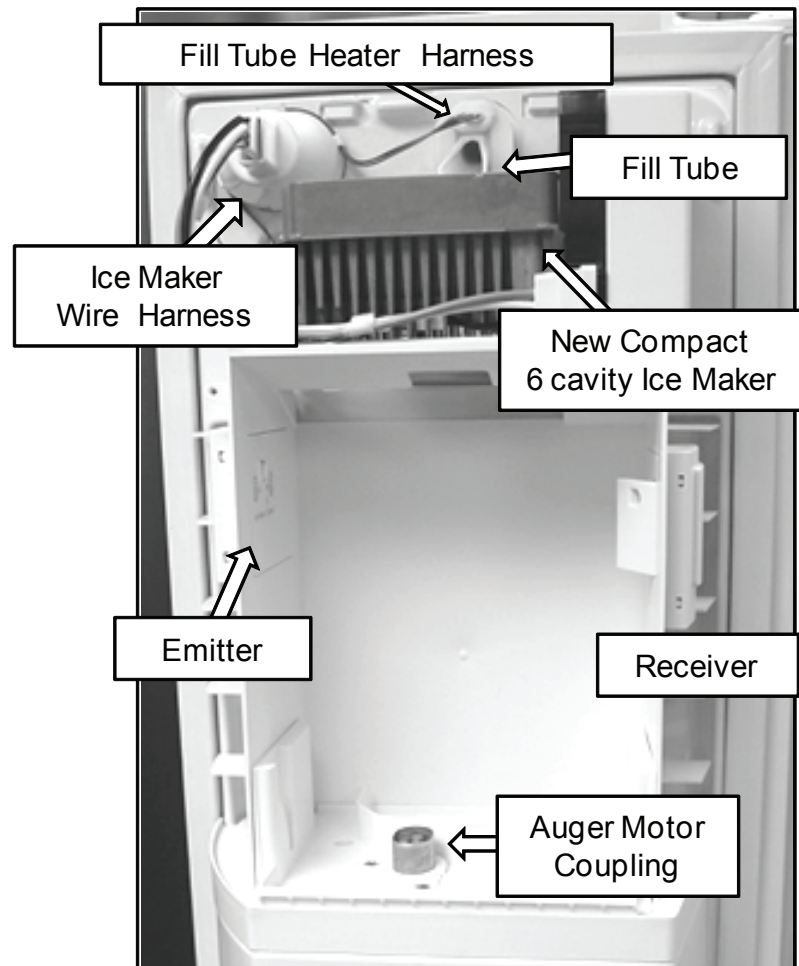
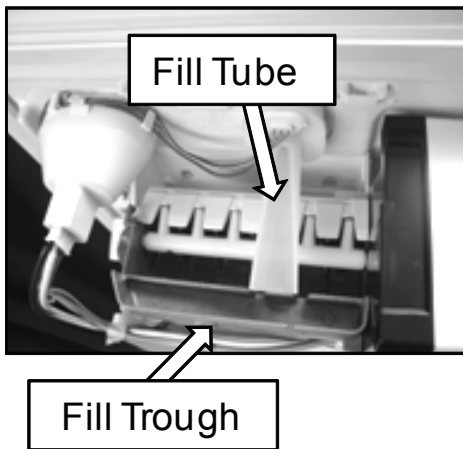

## Freezer Components (continued)

### Accessing New In Door Ice Maker

5. Remove the ice maker wire harness cover and disconnect the harness.

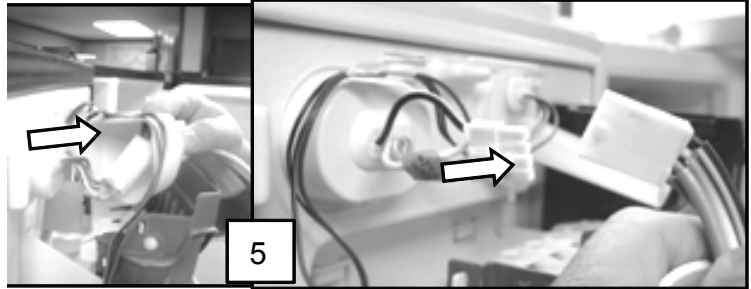

6. Disconnect the wire harness to the emitter and receiver boards.

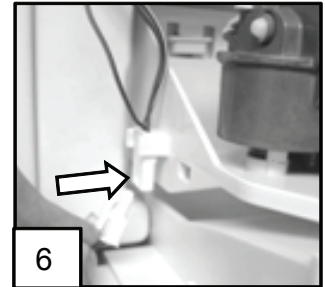

7. Remove 2 - 1/4" screws under the ice maker.

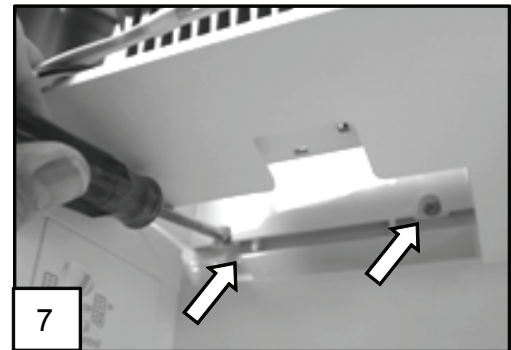

8. Slide out the ice maker to remove.

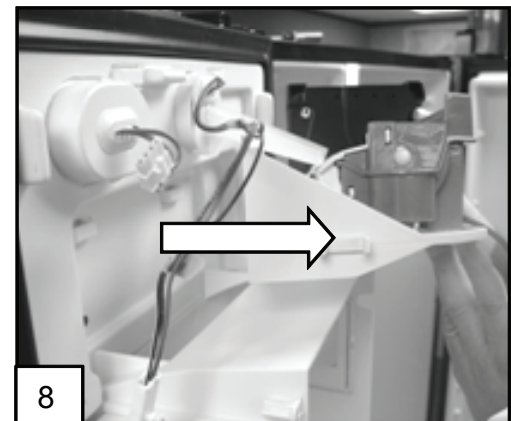

9. Remove 3 - 1/4" screws to remove housing from the ice maker mold.

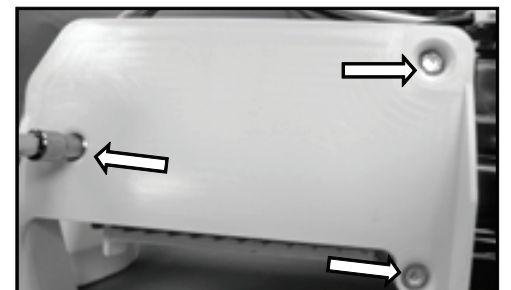

## Freezer Components (continued)

### Accessing New In Door Ice Maker

10. Unplug the wire harness from the ice maker head.

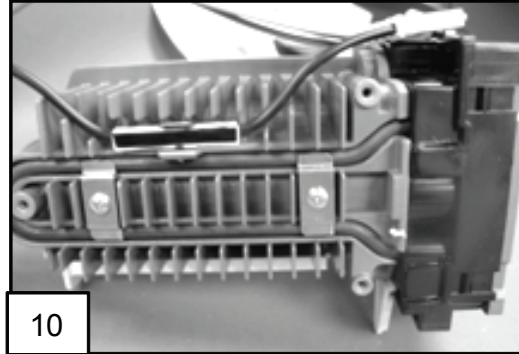

11. Slide off the Hi Limit control from the mold.

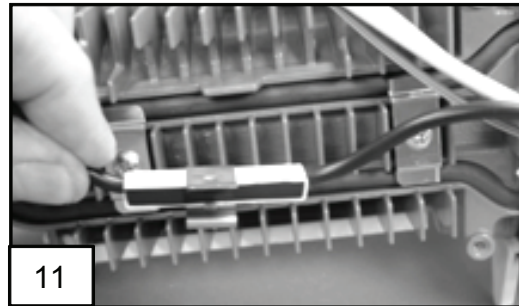

# Freezer Components (continued)

## Ice maker

### New Six Cavity Ice Maker Component Identification

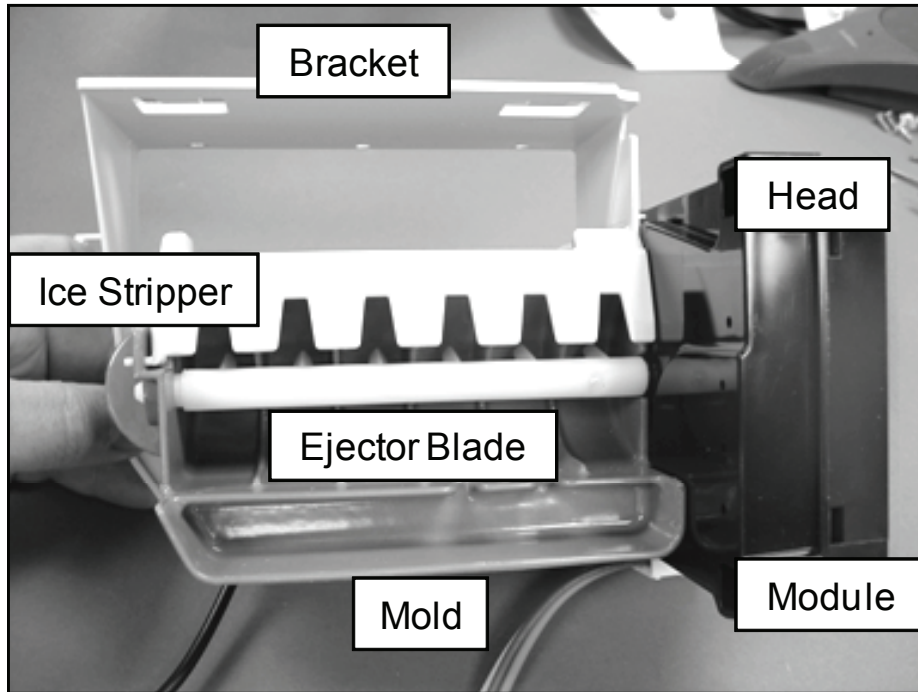

### Components

#### Disassembling the ice maker.

1. Remove the ice maker cover. A module similar to the existing product is used. The module is checked exactly as the current module. Refer to ice maker tech sheet shipped with the product” See next page.
2. Remove three screws that secure the module to the head.

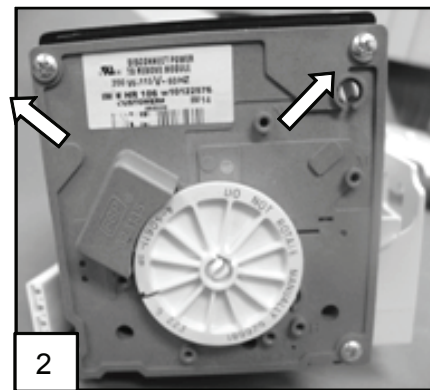
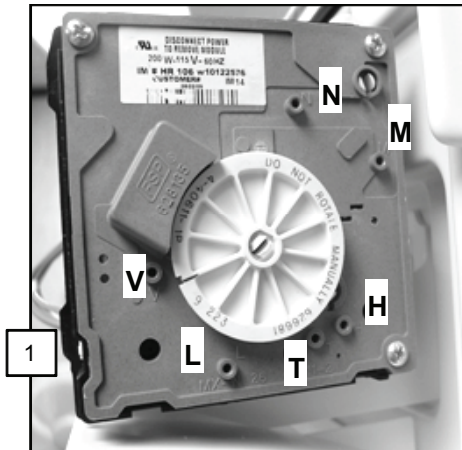

Jumper “T” to “H” to start harvest cycle

Continued next page

## Freezer Components (continued)

**! DANGER**



**Electrical Shock Hazard**  
Only authorized technicians should perform diagnostic voltage measurements. After performing voltage measurements, disconnect power before servicing. Failure to follow these instructions can result in death or electrical shock.

**! WARNING**



**Electrical Shock Hazard**  
Plug into a grounded (earthed) outlet. Replace all parts and panels before operating. Failure to do so can result in death or electrical shock.

## Voltage Measurement Safety Information

When performing live voltage measurements, you must do the following:

- Verify the controls are in the off position so that the appliance does not start when energized.
- Allow enough space to perform the voltage measurements without obstructions.
- Keep other people a safe distance away from the appliance to prevent potential injury.
- Always use the proper testing equipment.
- After voltage measurements, always disconnect power before servicing.

To check for proper voltage, complete the following steps:

1. Disconnect power.
2. Connect voltage measurement equipment.
3. Reconnect power and confirm voltage reading.
4. Disconnect power after performing voltage measurement.

### MODULAR ICE MAKER & ICE LEVEL DETECTOR SERVICE SHEET

#### ICEMAKER SPECIFICATIONS (120 VOLT MODEL):

COMPONENT	25' & 27' MODELS	22' MODELS
WATER FILL	130CC, 7.5 SEC	86CC, 7.5 SEC
MOLD HEATER	Non-Finned: 185 WATTS, 72 OHMS Finned: 260 WATTS, 51 OHMS	All: 185 WATTS, 72 OHMS
THERMOSTAT (BIMETAL)	CLOSE 17° +/- 3° OPEN 32° +/- 3°	
MOTOR	3.2-1.5 WATTS, 4,400-8,800 OHMS	
MODULE	STAMPED CIRCUIT, PLUG IN CONNECTORS	
CYCLE	ONE REVOLUTION (EJECTS ICE & WATER FILL)	

#### MODULE OHMMETER CHECKS (NO POWER TO ICEMAKER & EJECTOR BLADES IN PARK)

TEST POINTS	COMPONENT	MODULE POSITION	OHMS
L - H	MOLD HEATER	ATTACHED TO SUPPORT	72 / 51 (see mold heater above)
L - M	MOTOR	DISCONNECT FROM SUPPORT	8800

#### ICEMAKER MODULE

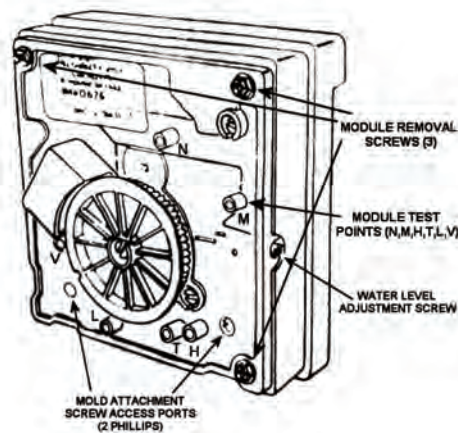

# Freezer Components (continued)

## MODULE VOLTAGE CHECKS WITH METER OR TEST LIGHT (POWER TO ICEMAKER)

TEST POINTS	COMPONENT	LINE VOLTAGE	Ø VOLTS
L - N	MODULE	POWER OK	NO POWER
T - H	BIMETAL	OPEN	CLOSED
L - H	HEATER	ON	OFF
L - M	MOTOR	ON	OFF
N - V	WATER VALVE	ON	OFF

## WATER LEVEL ADJUSTMENT

TURNING THE ADJUSTMENT SCREW (SEE PICTURE ABOVE) CLOCKWISE DECREASES THE WATER FILL.

· MAXIMUM ADJUSTMENT IS ONE FULL TURN IN EITHER DIRECTION. ADDITIONAL ROTATION COULD DAMAGE THE MODULE.

## ICEMAKER DIAGNOSTICS PROCEDURE:

1. PERFORM THE OPTICS DIAGNOSTIC PROCEDURE			
OPTICS DIAGNOSTICS PROCEDURE:			
STEP #	STATUS LED	POSSIBLE CAUSES	ACTION
A. OPEN THE FREEZER DOOR	1.A.1. 2 PULSES FOLLOWED BY A 1 SECOND DELAY. (REPEATED)	THE FLAPPER DOOR ON THE EMITTER IS BLOCKING THE BEAM.	GO TO STEP 2.
		THE OPTICS ARE FAULTY	GO TO STEP 2.
	1.A.2. NO LAMP	ICEMAKER IS IN THE HARVEST MODE.	PRESS IN THE FREEZER DOOR SWITCH. WHEN IN THE HARVEST MODE THE STATUS LED WILL BLINK 1 FLASH EVERY SECOND.
FAULTY DIAGNOSTICS LED		REPLACE RECEIVER BOARD.	
B. PRESS IN THE EMITTER FLAPPER DOOR TO UNBLOCK THE BEAM.	1.B.1. PULSES FOLLOWED BY A 1 SECOND DELAY. (REPEATED)	THE OPTICS ARE FAULTY	REPLACE EMITTER & RECEIVER BOARD
		OPTICS ARE WORKING CORRECTLY	CLOSE FREEZER DOOR
2. DISCONNECT THE POWER SUPPLY 3. SLIDE THE ICEMAKER OUT, REMOVE COVER. 4. JUMP "T" & "H" TO BYPASS THE BIMETAL AND START A HARVEST. 5. CONNECT THE POWER SUPPLY. 6. CLOSE THE FREEZER DOOR TO ALIGN THE OPTICS AND A HARVEST CYCLE WILL BEGIN IN 5 SECONDS. 7. OPEN THE FREEZER DOOR AND OBSERVE THE ICEMAKER. <i>IF "T" TO "H" IS PROPERLY JUMPED AND THE ICEMAKER WON'T RUN STOP TEST AND CHECK THE ICEMAKER.</i>	8. REMOVE THE JUMPER BEFORE THE FINGERS REACH 10:00. REINSTALL THE ICEMAKER OR BE PREPARED TO CATCH THE WATER FILL. 9. IMMEDIATELY DISCONNECT POWER AFTER THE WATER FILL. 10. WITH THE FREEZER DOOR CLOSED, RECONNECT THE POWER SUPPLY. 11. WAIT 5 SECONDS AND OPEN THE FREEZER DOOR AND WATCH THE STATUS LED.	<b>STATUS LED OUTPUT CODE:</b>  <b>4 PULSES, REPEATED ONCE</b> INDICATES THE RELAY IS DEFECTIVE. REPLACE BOTH THE EMITTER AND RECEIVER BOARDS. <b>3 PULSES, REPEATED ONCE,</b> INDICATES OPTICS AND RELAY ARE GOOD, BUT I/M IS NOT BEING SENSED/WILL NOT OPERATE. <ul style="list-style-type: none"> <li>• CHECK BAIL ARM SWITCH. (MUST BE ON)</li> <li>• CHECK I/M CIRCUIT AND CONNECTIONS BACK TO THE RECEIVER BOARD AND NEUTRAL.</li> <li>• CHECK I/M COMPONENTS.</li> </ul> <b>2 PULSES, REPEATED ONCE,</b> INDICATES OPTICS ARE DEFECTIVE. REPEAT STEP ONE AND REPLACE BOTH BOARD IF NECESSARY. <b>STEADY LIGHT FOR 5 SECONDS</b> INDICATES THE RELAY AND OPTICS ARE GOOD, AND THE RECEIVER SENSES THE ICEMAKER. <b>NO LIGHT,</b> UNPLUG THE REFRIGERATOR FOR 5 SECONDS AND REPEAT TEST.	

PART NO. 2220407 REV. A

## Freezer Components (continued)

### Disassembling the ice maker (continued)

3. Separate the module from the head.

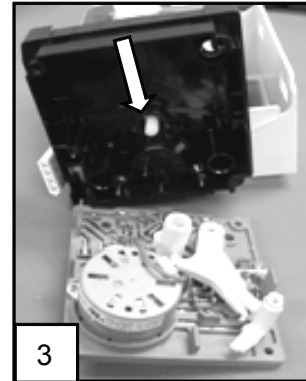

4. Remove two screws on the bottom of the ice maker head and separate the head from the mold. The thermostat can be removed at this point.

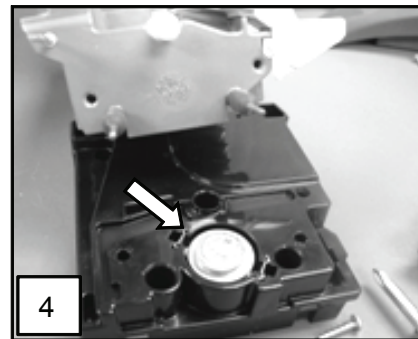

5. When replacing the thermostat apply a coating of Alumilastic to the mold. This will provide a thermal bond between the mold and thermostat.

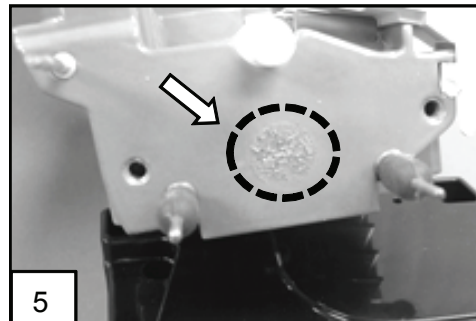



## Freezer Components (continued)

### Replacing Auger Motor and Related Components

1. Remove 2 screws and lift off cover.

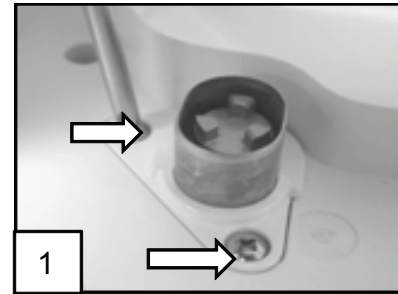

2. Remove the coupling by lifting straight up. A spring is captured under the coupling.

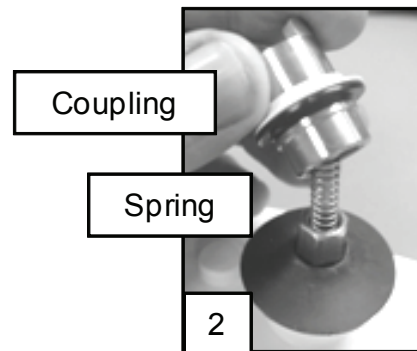

3. To access the motor remove the 4 - 1/4" screws securing the chute to the housing.

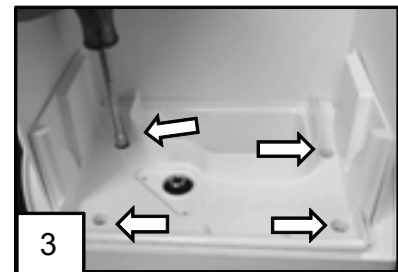

4. Lift out the chute. The chute may require some effort to remove because of the foam seal around the chute tube.

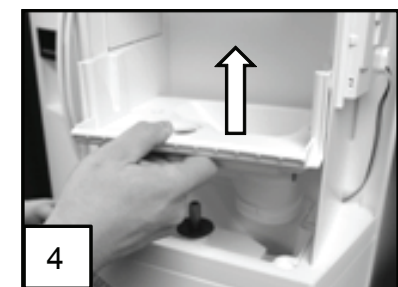

5. Inspect seal and repair or replace if necessary before reassembly.

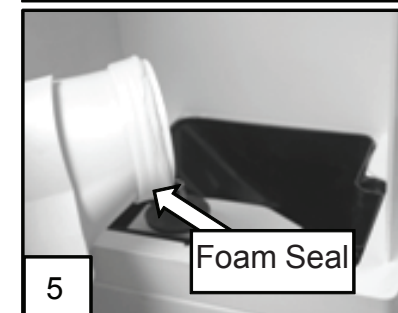

## Freezer Components (continued)

### Removing Auger Motor

6. Remove 4 - 1/4" screws securing the motor to the housing .

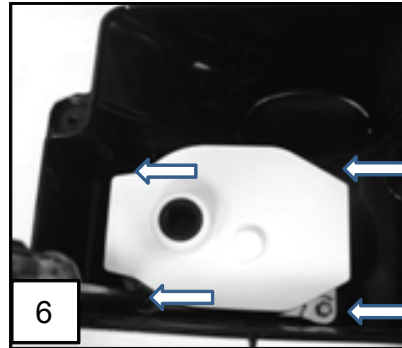

7. Lift up the auger motor and disconnect the wire harness.

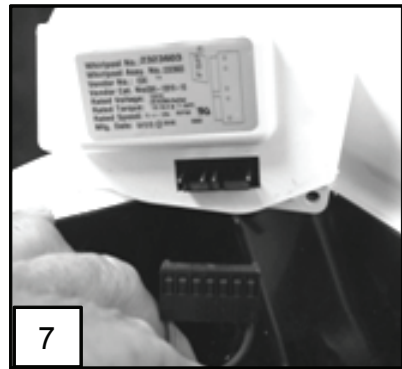

### Condensate Drain

Under normal operating conditions, moisture may accumulate in the bottom of the auger motor housing. A drain hole is provided to allow water to pass through the inner door panel and drop onto the lower shelf, see figure 2.

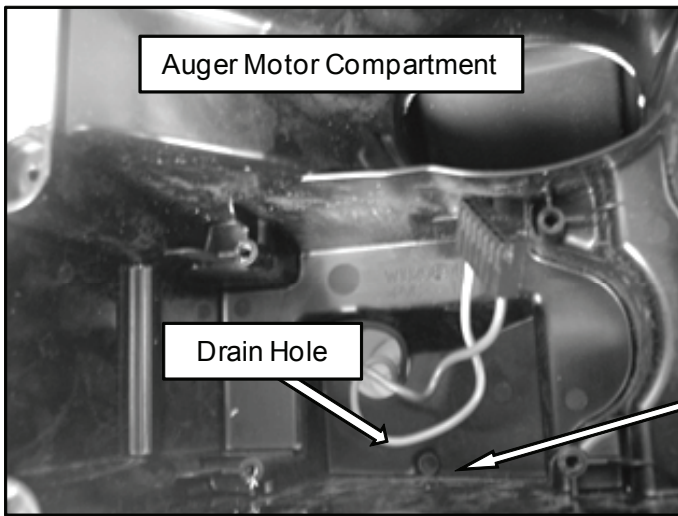

Figure 1

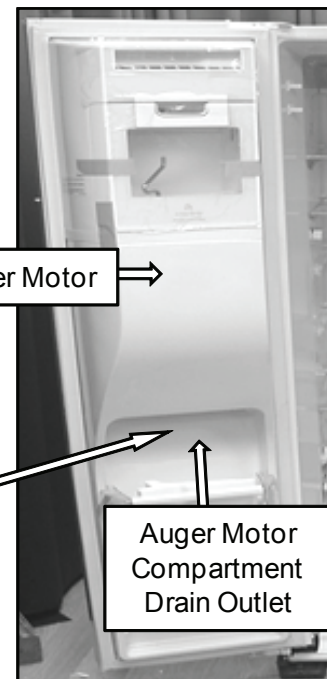

Figure 2

## Freezer Components (continued)

### Checking the Auger Motor

**⚠ WARNING**



#### Electrical Shock Hazard

Disconnect power before servicing.

Replace all parts and panels before operating.

Failure to do so can result in death or electrical shock.

Unplug refrigerator or disconnect power. Connect an Ohmmeter across the 2 motor terminals and measure the resistance. The resistance should be approximately 210 Ohms plus or minus 10%.

### Removing Emitter and Receiver Boards

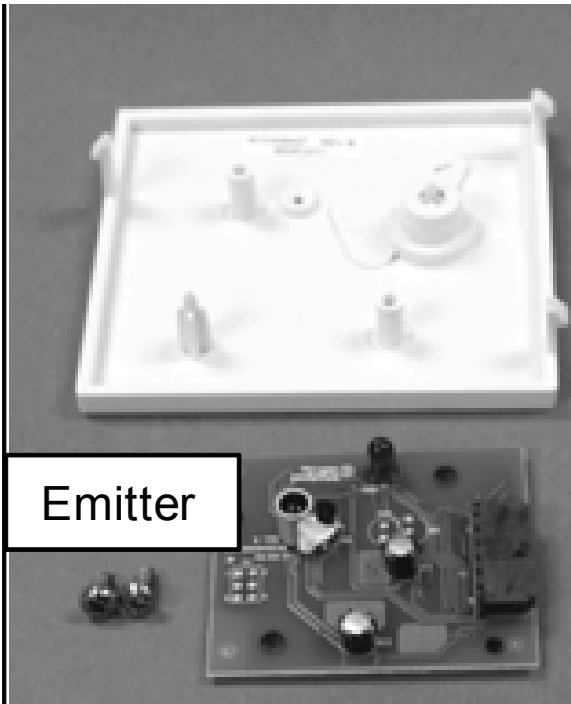

Release 3 tabs to remove the emitter and receiver boards from the housing.

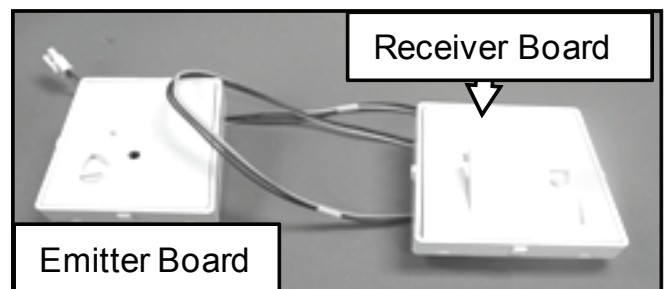

## Freezer Components (continued)

### Water Tube Routing

Water Routing: the home water supply is connected to the isolation valve. The outlet of the isolation valve connects to the water filter located in the refrigeration compartment. The outlet of the filter connects to the inlet of the water reservoir. The water reservoir outlet connects to the inlet of the dual valve.

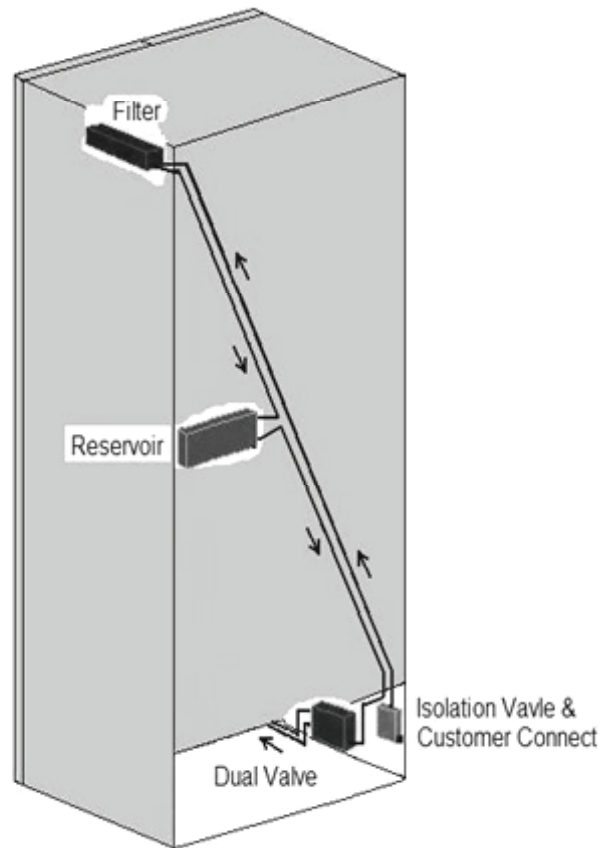

### Freezer Door

The ice maker fill tube and the water dispenser tube are routed through the hole in the lower freezer door hinge.



# DISPENSER AND USER INTERFACE

## Stealth Control

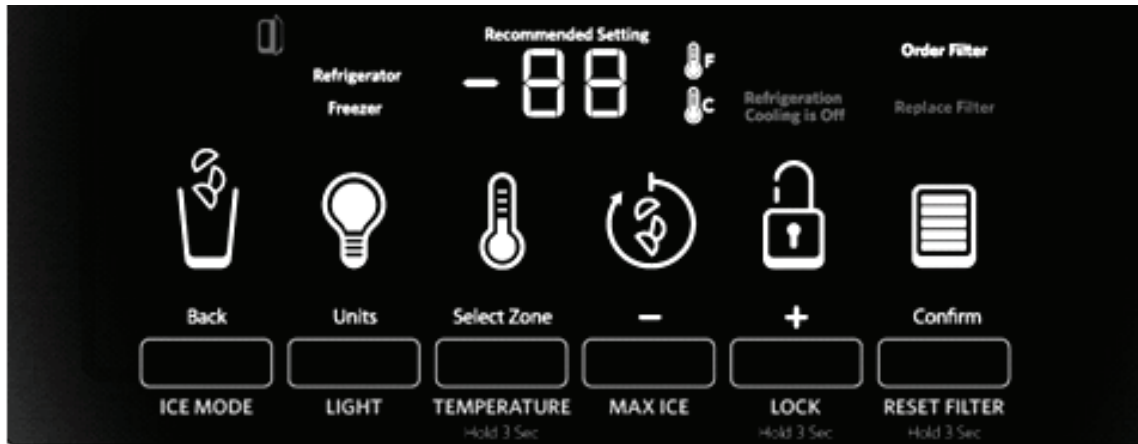

Figure 1 – Whirlpool Stealth User Interface/Blue LED's except as noted.

The icons used on this Whirlpool user interface display are similar to those used on other SXS models but not identical. The basic operation and programming is the same.

# Programming (continued)

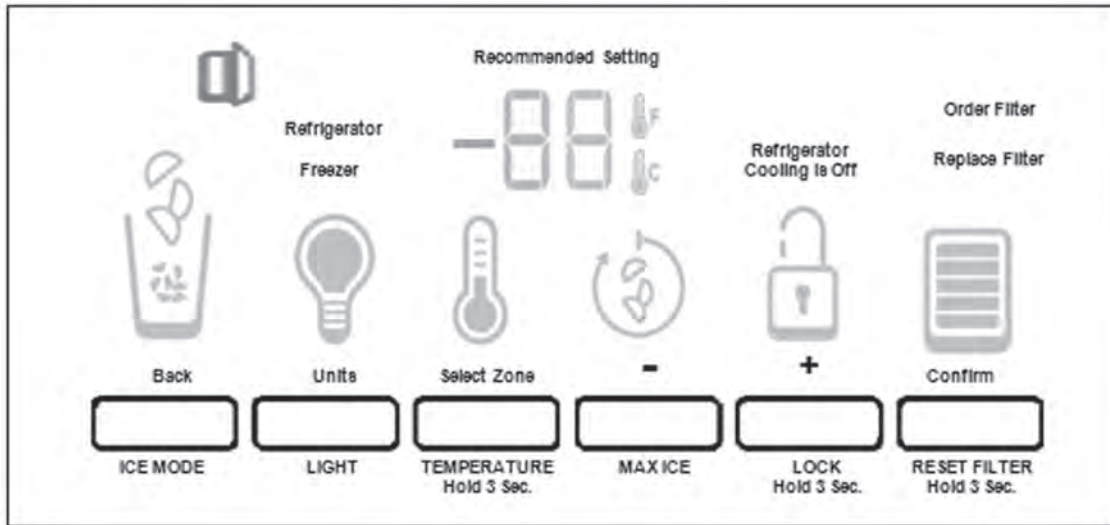

Figure 3 – KitchenAid Interface Icon Identification

Figure 3 depicts all the ICONS and Text located on the Display. Specific Icons will be displayed at different steps during programming as explained in this manual.

## Sleep Mode

The display screen on the dispenser control panel will turn off automatically and enter “sleep” mode when the control buttons and dispenser levers have not been used for 2 minutes or more. See figure 4.

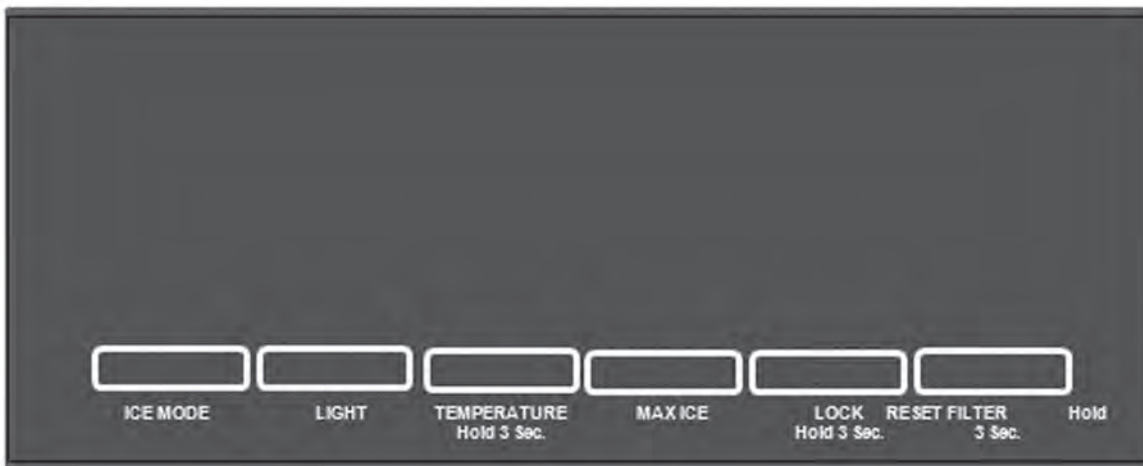

Figure 4 – Hibernate/Sleep Mode Screen

While in “sleep” mode, the display is dark

## Programming (continued)

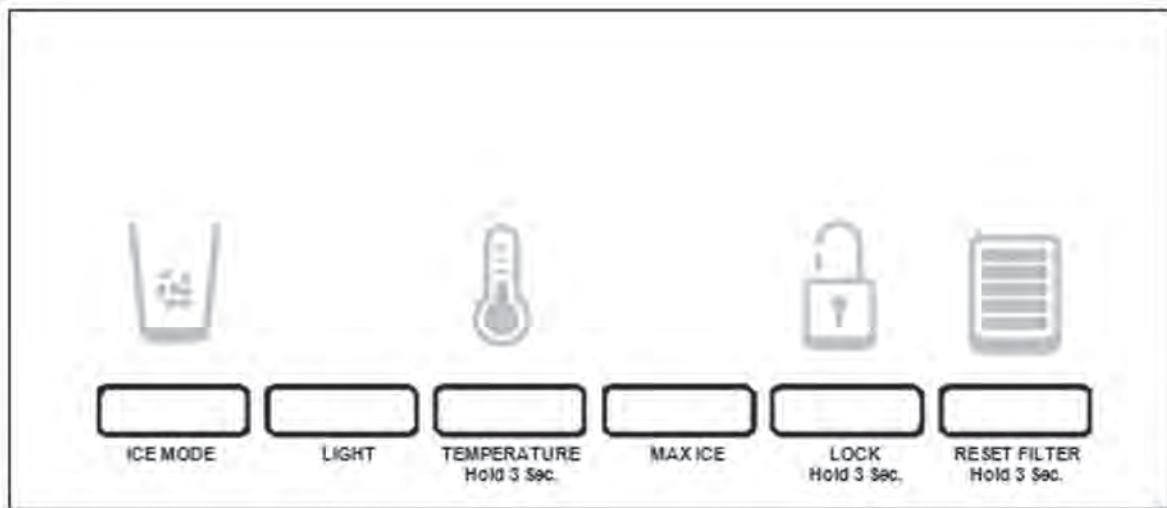
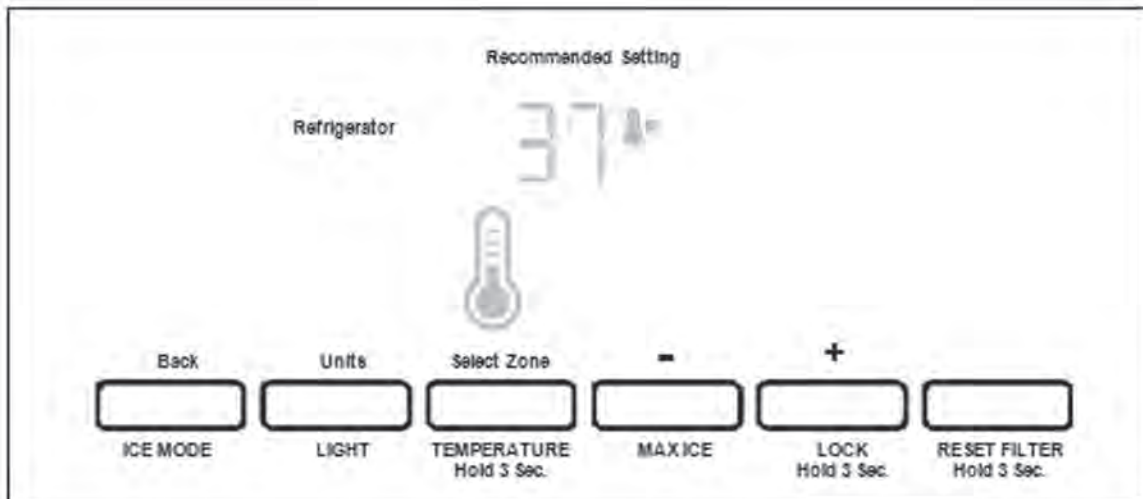

Figure 5

Pressing any control button will activate the “Normal/Home” display screen, without changing any settings. See figure 5. After activation, changes to any settings can then be made. If no changes are made within 2 minutes, the display will re-enter “sleep” mode.

### Factory Preset Temperatures

The refrigerator and freezer controls are preset at the factory. The factory recommended set points are 37°F (3°C) for the refrigerator and 0°F (-18°C) for the freezer.



### To View and Adjust Set Points:

Press and hold the TEMPERATURE button for 3 seconds. When adjust mode is activated, the display screen shows the refrigerator set point and “REFRIGERATOR” appears in the display. See figure 6.

## Programming (continued)

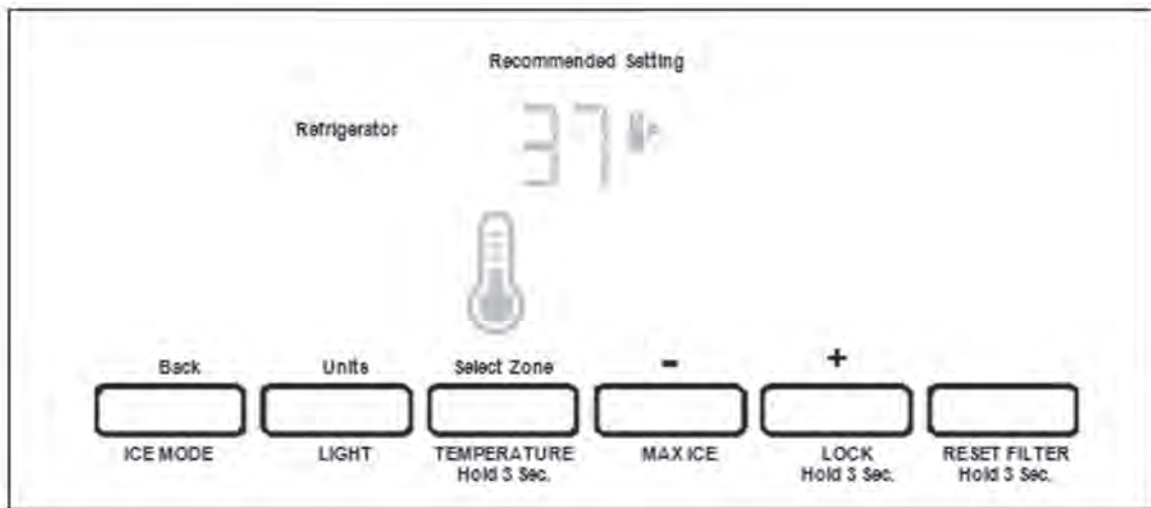

### Adjusting Temperature Set Points: Figure 7

Pressing and holding TEMPERATURE starts a 3 second countdown. During the countdown using the dispenser cancels the countdown and no dispensing is permitted. The number 3 blinks 3 times and an invalid tone sounds 3 times,. The user has to release both the pad and the button and press the button again to start the countdown over. During the countdown, pressing any other button or releasing the pad cancels the countdown. The user has to start over. Please note: the blinking and toning is synchronized so that the moment the number '3' blinks, the tone is sounded. After 3 seconds, the TEMPERATURE shows up with the CURRENT refrigerator setting.

See figure 7.

Pressing TEMPERATURE changes between the refrigerator and freezer compartments and displays the current setting. Pressing the ICE MODE pad or after 60 seconds of no activity, the display will revert back to the normal screen.



## Programming (continued)

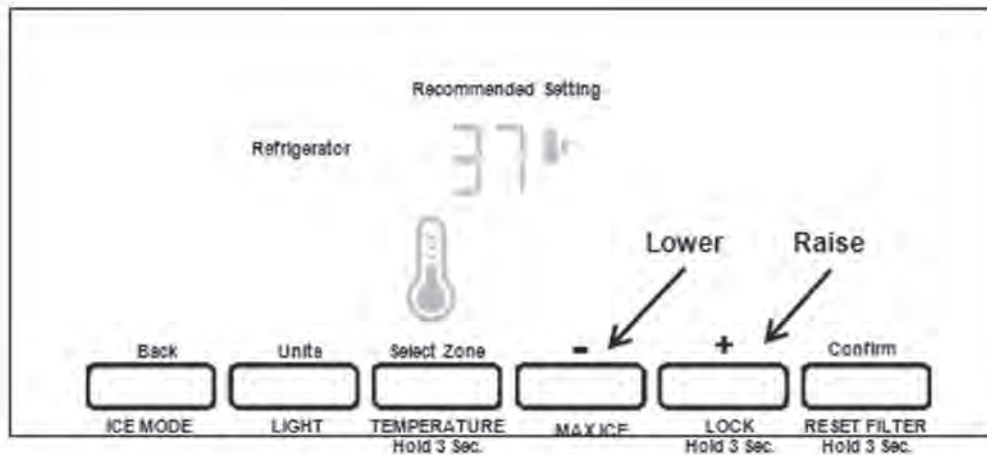

Figure 8

### Adjusting Temperature Settings

Press the LOCK pad to raise the temperature set point or press the MAX ICE pad to lower the temperature set point.

See figure 8.

**IMPORTANT:** When the temperature is changed, the word “CONFIRM” above the filter reset pad illuminates and will flash without an audible tone constantly until user presses RESET FILTER, ICE MODE or after 60 seconds of inactivity. If the user presses TEMPERATURE to change compartments, CONFIRM still flashes if one of the temps has been changed.

**NOTE:** To view Celsius temperatures, press the LIGHT button when adjust mode is activated.

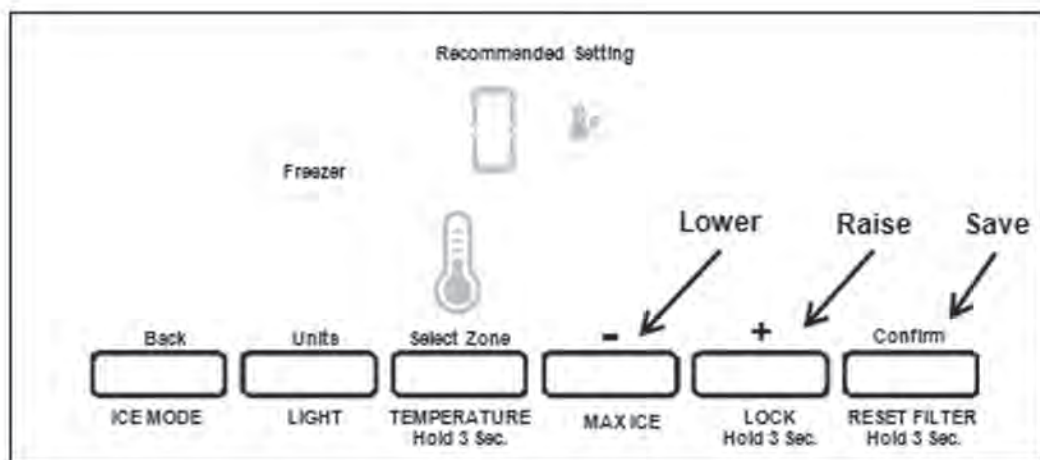

Figure 9

### Freezer Temperature Setting

After viewing (and adjusting if desired) the refrigerator set point, press TEMPERATURE to change the display to show the freezer set point. When the zone has been changed, “FREEZER” appears on the display screen. Press LOCK to raise the set point, or press MAX ICE to lower the set point. When you have finished viewing (and adjusting if desired) both the refrigerator and freezer set points, press FILTER to save the settings. See figure 9.

## Programming (continued)

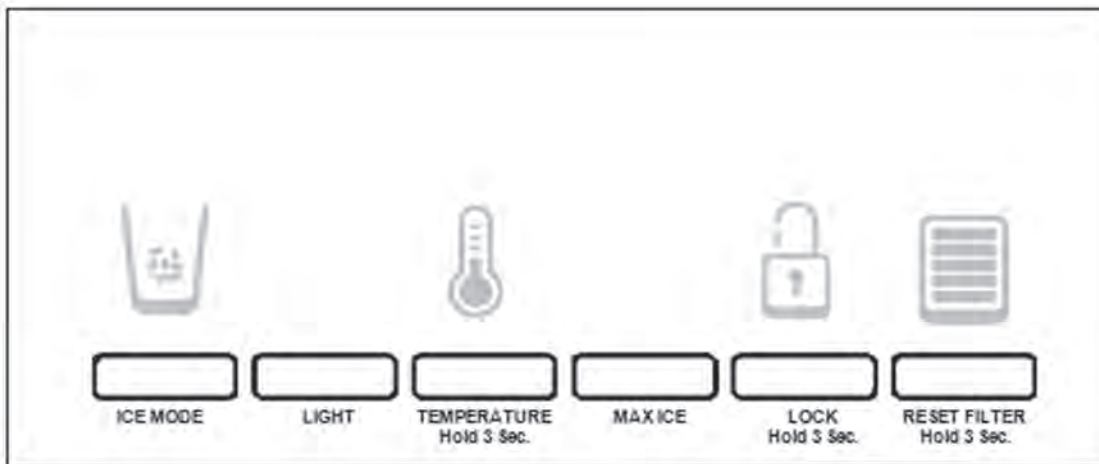

Figure 10

### Ice Dispenser:

Ice dispenses from the ice maker storage bin in the freezer when the dispenser lever is pressed. The ice maker can produce both crushed and cubed ice. Before dispensing ice, select which type of ice you prefer by pressing the ICE MODE button. The display screen indicates which type of ice is selected. See figure 10.

For crushed ice, cubes are crushed before being dispensed. This may cause a slight delay when dispensing crushed ice. Noise from the ice crusher is normal, and pieces of ice may vary in size. When changing from crushed to cubed, a few ounces of crushed ice will be dispensed along with the first cubes.

**NOTE:** Ice may continue to dispense for up to 10 seconds after removing the glass from the lever. The dispenser may continue to make noise for a few seconds after dispensing.

## Programming (continued)

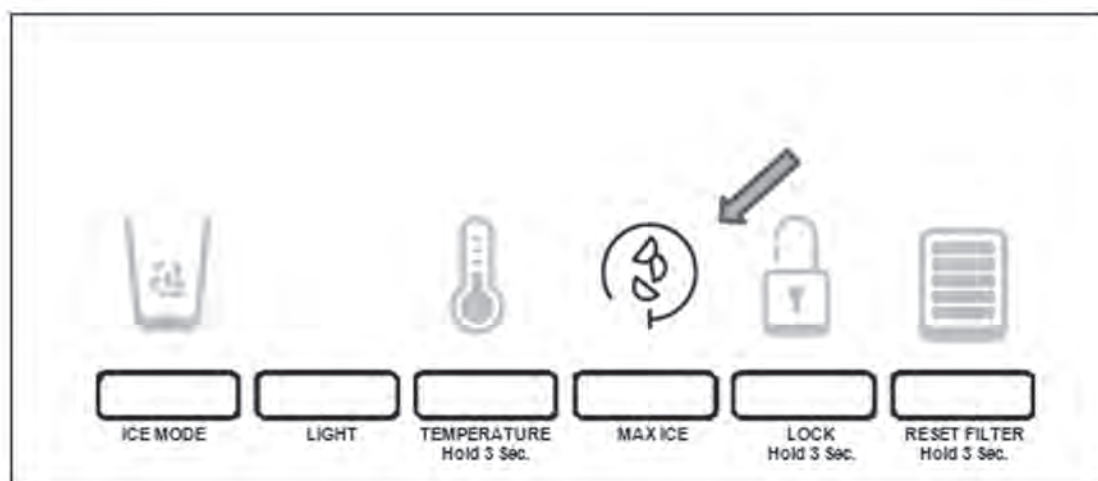

Figure 11

### Max Ice:

The Max Ice feature assists with temporary periods of heavy ice use by increasing ice production over a 24-hour period.

**IMPORTANT:** This feature only works if the ice maker is turned on. Press MAX ICE to turn on this feature. When the feature is on, the Max Ice icon will appear on the dispenser display screen. See figure 11.

The Max Ice setting will remain on for 24hours unless manually turned off. To manually turn off the Max Ice feature, press MAX ICE again or adjust the freezer temperature set point. The MAX ICE icon will disappear when the feature is off.

**NOTE:** If increased ice production is desired at all times, change the freezer set point to a lower setting. Setting the freezer to a colder temperature may make some foods, such as ice cream harder.

## Programming (continued)

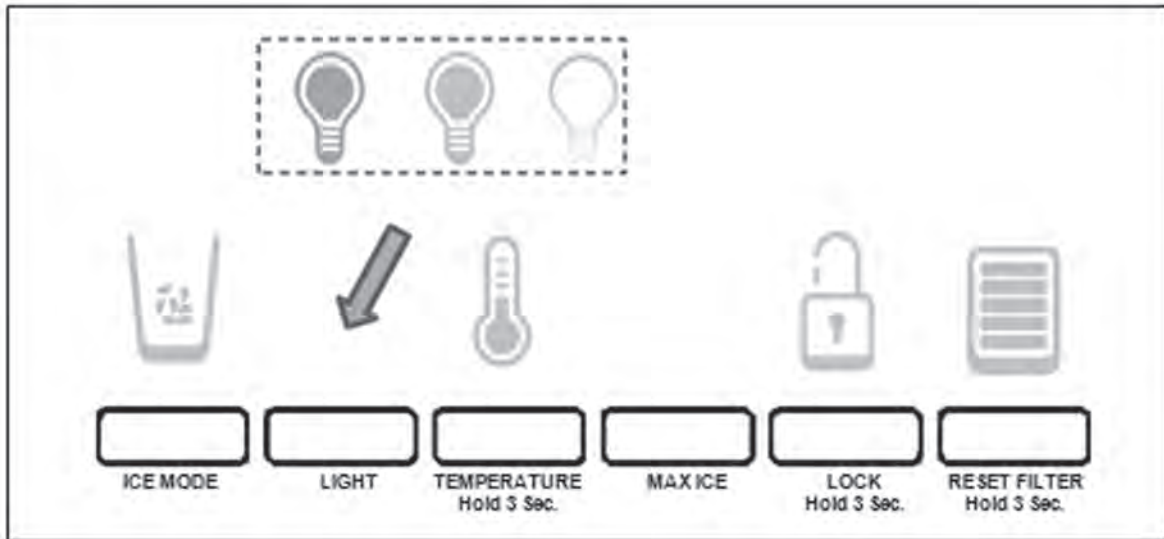

Figure 12

### Dispenser Light:

When you use the dispenser, the light will automatically turn on. If you want the light to be on continuously, you may choose either ON or DIM.

The display screen indicates which mode is selected. See figure 12.

ON: Press LIGHT to turn the dispenser light on at 100%

DIM: Press LIGHT a second time to select DIM mode. The dispenser light will remain on, but at a lower 50% intensity.

OFF: Press LIGHT a third time to turn the dispenser light off

**Note:** If the setting is changed it will remain that way.

## Programming (continued)

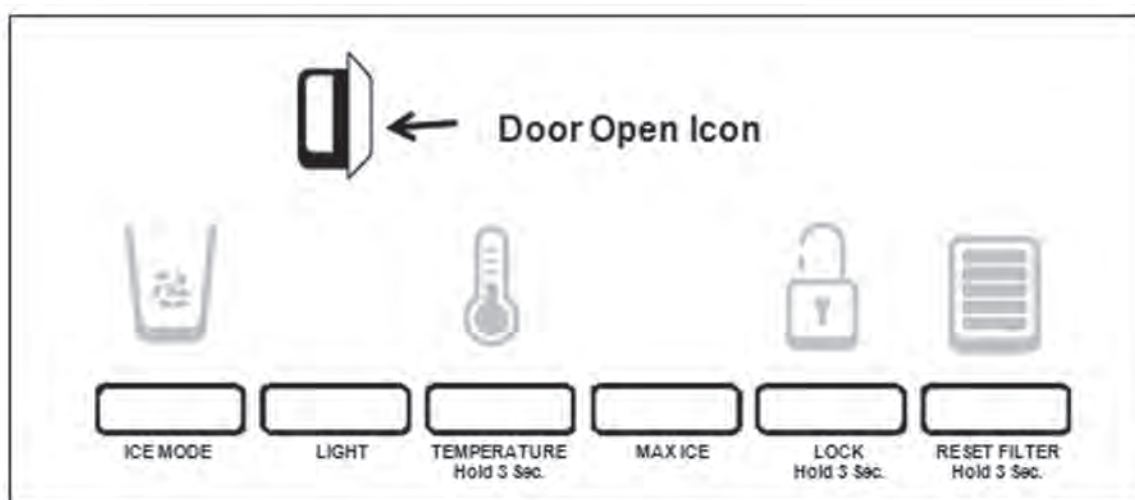

Figure 13

### Door Open Alarm

The Door Open Alarm feature sounds an alarm when the refrigerator or freezer door is open for 5 minutes and the product cooling is turned on. The alarm will repeat every 2 minutes. Close both doors to turn it off. The feature then resets and will reactivate when either door is left open again for 5 minutes.

#### Details:

When a door is open for 5 minutes and the cooling function is on:

The Door Open Icon and the normal screen is displayed.

The Door Open chime is sounded 3 times.

The Door Open Icon appears and blinks 7 times and then becomes constant.

If a door is left open, every 2 minutes, the Door Open chime sounds 3 times, the Door Open icon blinks 7 times and then becomes constant.

**NOTE:** Since inactivity to sleep is also 2 minutes, the door open situation shall override the sleep mode. In other words, the user interface will not go to the sleep mode if it is in the Door Open mode.

When the door open alert condition is met (door open for 5 min), pressing any button on the control panel at any time will turn off the Door Open Alert Chime.

The other door open functions, flashing door open icon, and the door reset timer continue until the next door open alert occurs. This will continue until the both door are closed.

**NOTE:** To mute the audible alarm while keeping the doors open, such as while cleaning the inside of the refrigerator, press any button on the control panel. The alarm sound will be temporarily turned off, but the Door Open icon will still be displayed on the dispenser control panel. See figure 13.

## Programming (continued)

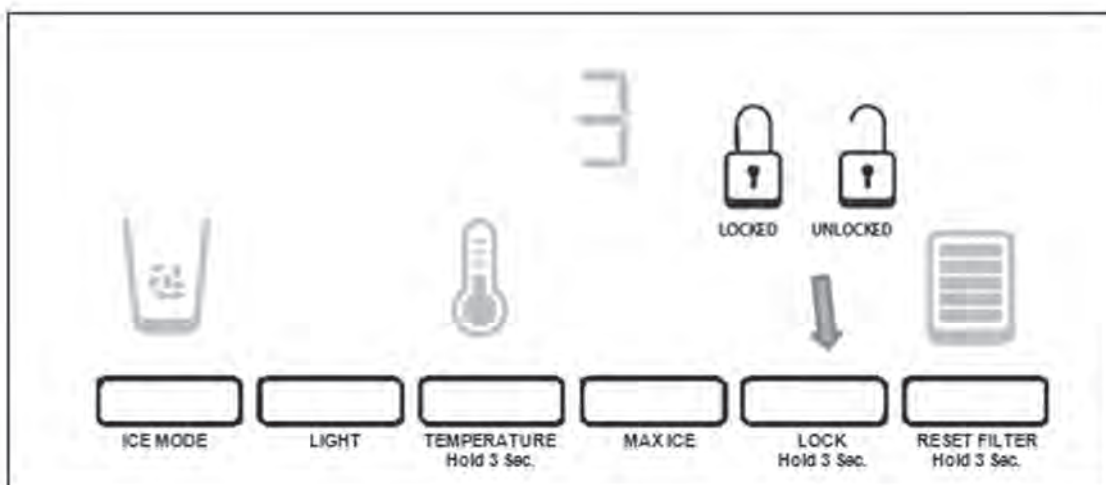

Figure 14

### Dispenser Lock:

The dispenser can be turned off for easy cleaning or to avoid unintentional dispensing by small children and pets.

**NOTE:** The lock feature does not shut off power to the refrigerator, to the ice maker, or to the dispenser light. It simply deactivates the controls and dispenser levers.

#### Details:

Pressing and holding LOCK starts a 3 second countdown. During the countdown, using the dispenser cancels the countdown and no dispensing is permitted. During the countdown pressing any other button or releasing the Lock button cancels the countdown.

After 3 seconds, the user interface is locked. See figure 14. No functions will occur during cooling off. No status is displayed except for LOCK, Door Open, and Cooling Off. Pressing any button or pad (except for LOCK or the COOLING OFF key dance) will wake up the lock screen if it has gone to sleep. The Lock icon will blink 3 times and the “invalid” tone sounds 3 times.

Pressing and holding LOCK for 3 seconds unlocks the user interface and the normal screen (if cooling is not off) is displayed depicting the ice mode, light status, lock status, or any alert icons exactly as before it was locked.

## Programming (continued)

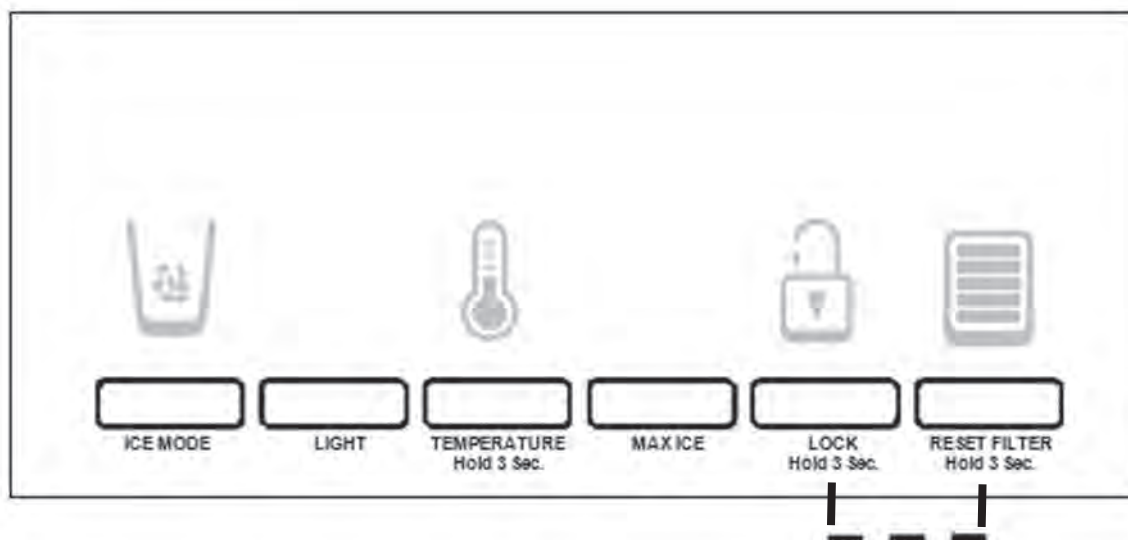

Figure 15

### Cooling Off Mode

Pressing and holding both LOCK and RESET FILTER simultaneously, see figure 15, starts a 3, 2, 1 second countdown. During the countdown, using the dispenser cancels the countdown AND no dispensing is permitted.

After 3 seconds, the 'cooling off' icon appears and flashes 7 times then remains on. All the rest of the icons including door open turn off.

Exception: if the UI is locked the user can still turn cooling off. The 'COOLING OFFF' icon will be displayed along with the lock icon. The only keys available to the user are the lock key to unlock the control which returns to the standard cooling mode. When any other key is pressed, an error beep will be sounded.

If the customer is in "normal mode" (not in locked mode) and the customer turns cooling off, only the cooling off icon will show. The only keys available to the customer is the cooling on/off key dance combination. When any other keys are pressed, an error beep will be sounded.

The cooling off screen will stay on all the time and does not go to sleep. If cooling is off when power is interrupted, it will remain in the cooling off mode when power is restored.

During "COOLING OFF" (if the UI is not locked), ice and water dispensing is allowed.

### Cooling On Mode

Pressing and holding LOCK and RESET FILTER again for 3 sec turns the cooling on. After cooling is turned on, the normal screen is displayed with the ice mode, light status, lock statue, filter status, or any alerts icons displayed exactly as before cooling was shut off.

## Programming (continued)

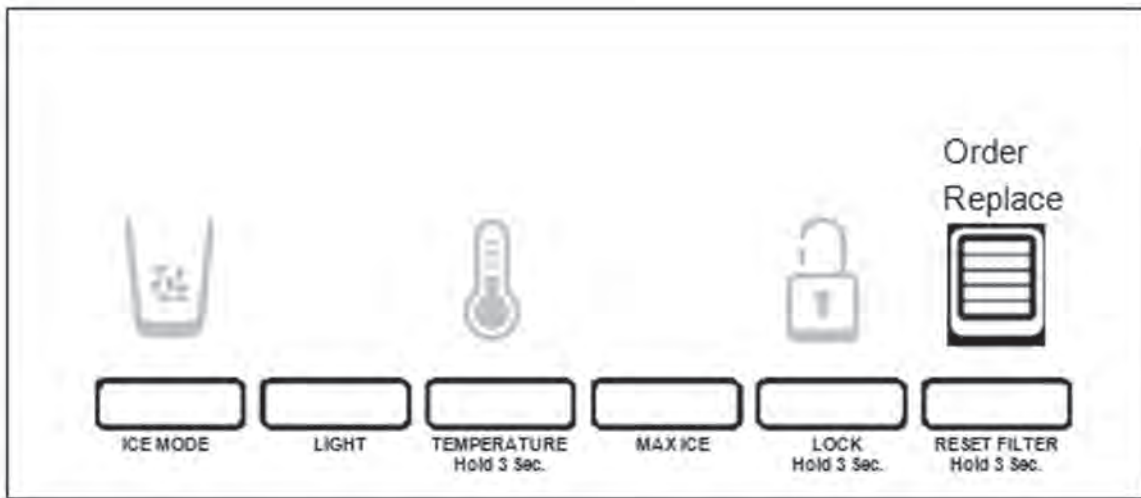

Figure 16

### Water Filter Status Light:

The water filter status light will help you know when to change your water filter.

When the dispenser control panel's water filter status display changes to "ORDER," this tells you that it is almost time to change the water filter cartridge.

Replace the water filter cartridge when the water filter status display changes to "REPLACE." The filter should be replaced at least every 6 months depending on your water quality and usage.

**NOTE:** If water flow to your water dispenser or ice maker decreases noticeably, change the filter sooner. After changing the water filter, reset the status light.

#### Details:

Pressing and holding RESET FILTER starts the 3 seconds countdown. Using the dispenser cancels the countdown AND no dispensing is permitted. The number '3' blinks 3 times and the 'invalid' tone sounds 3 times and user has to release both the pad and the button and press the button again to start it over

After 3 seconds, the BLUE WATER BARS in the Icon flash and an audible tone sounds 3 times. When the system is reset, the "ORDER" and "REPLACE" icons will disappear from the display screen. See figure 16.

Note: Users can reset the filter status at any stage.



## Programming (continued)

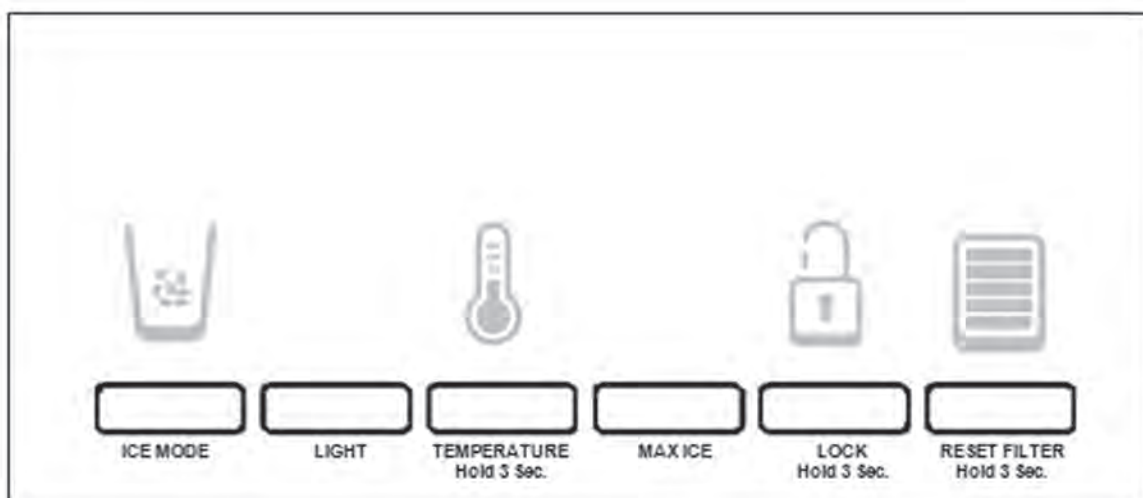

Figure 17

### Showroom Mode:

Pressing and holding LIGHT and MAX ICE starts a 3 second countdown. During the countdown, pressing any other button or releasing a pad cancels the countdown.

#### Details:

After 3 seconds, the control enters the showroom mode and the cooling system turns off.

When in the showroom mode, cooling off and WFI icons stay off all the time, while the Door Open icon appears whenever door is open, however there is no door open audible alert.

No ice or water dispensing is allowed, an 'invalid' tone sounds if a pad is pressed or pressed and held.

User is not allowed to turn cooling on or off if attempted. invalid tone sounds.

Pressing ICE MODE toggles cubed and crushed,

Pressing LIGHT toggles off/on/dim and lighting changes accordingly.

The user can enter the Temperature Setting menu, which works the same as previously described and the temperature will be stored. However, the moment the showroom mode is exited, the temperature will be set back to default.

After 1 minute in a temperature screen without activity the control returns to the normal screen.

Please note that 'cooling off' text will not be lit in the showroom mode

Note: The user interface will not go to sleep under any circumstances.

#### Exiting the Showroom Mode:

Pressing and holding LIGHT and MAX ICE again for 3 sec OR unplugging and plugging in the power cord exits the showroom mode and returns to normal operation.

# Dispenser Components

## Accessing User Interface and Dispenser Components

### **⚠ WARNING**



#### **Electrical Shock Hazard**

**Disconnect power before servicing.**

**Replace all parts and panels before operating.**

**Failure to do so can result in death or electrical shock.**

1. Disconnect power to the refrigerator.

2. Remove the drip tray and the grille.

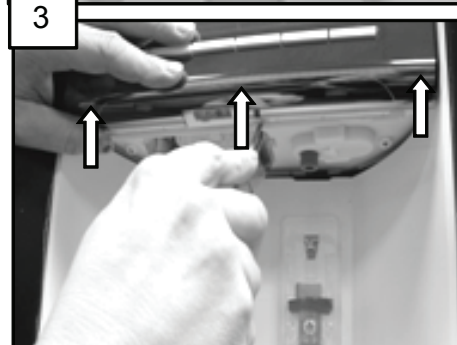
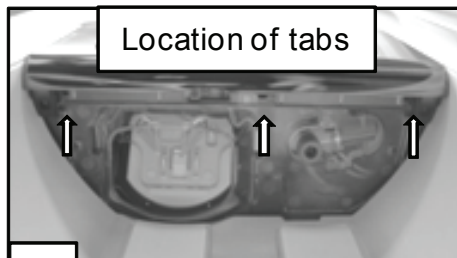
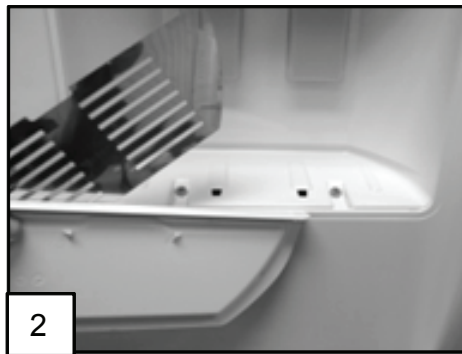

3. Release 3 locking tabs securing the user interface to the dispenser housing.

## Dispenser Components (continued)

4. Drop down the User Interface board.

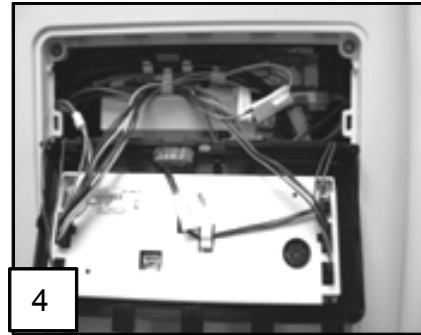

5. Remove the wire harnesses.

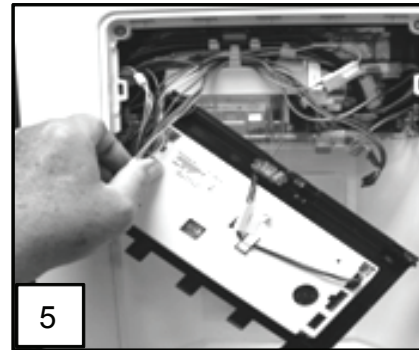

6. Remove the 4 screws securing the dispenser housing to the door panel.

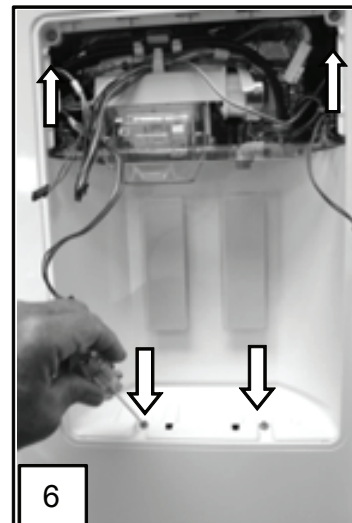

7. Disconnect the water tube from the dispenser assembly.



## Dispenser Components (continued)

8. Remove 2 - 1/4" hex head screws securing the dispenser assembly to the door panel.

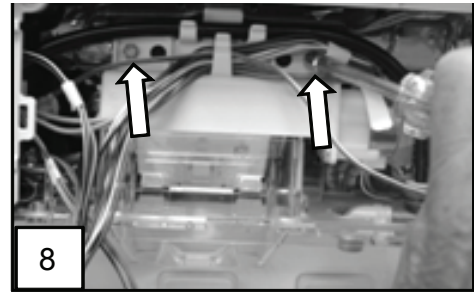

9. Remove the wiring harnesses from the dispenser bracket. Remove the wire harnesses.

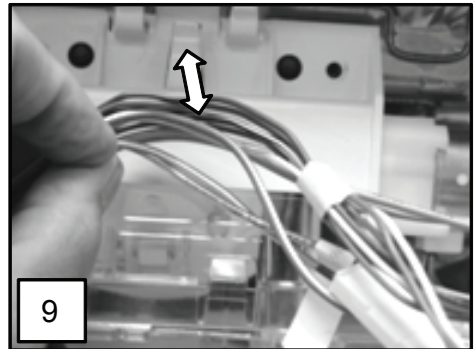

10. Release the retaining clips on the left and right side of the dispenser assembly.

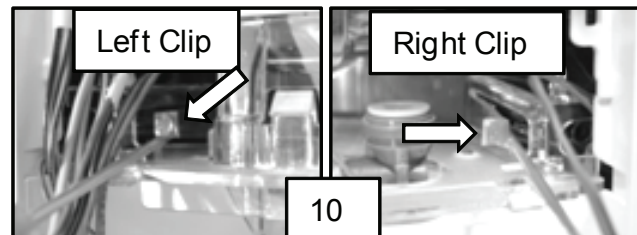

11. Pull the top of the dispenser housing out about 2" to allow removal of the dispenser assembly.

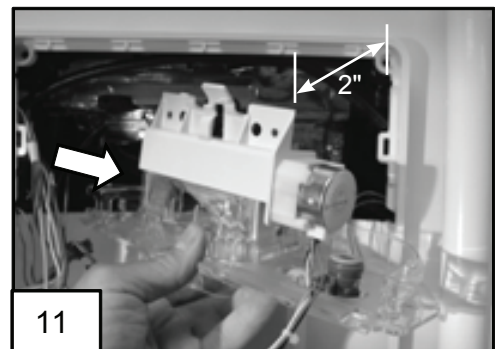

12. Remove two screws to replace the dispenser motor.

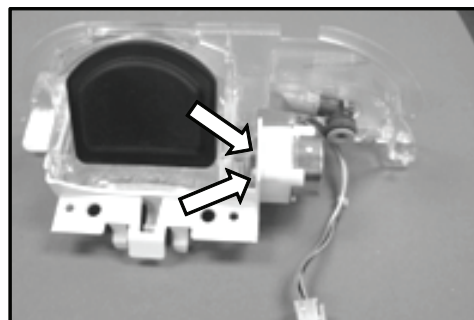

## Dispenser Components (continued)

13. The dispenser door can be snapped out to replace.

**NOTE:** The door can be replaced without removing the assembly.

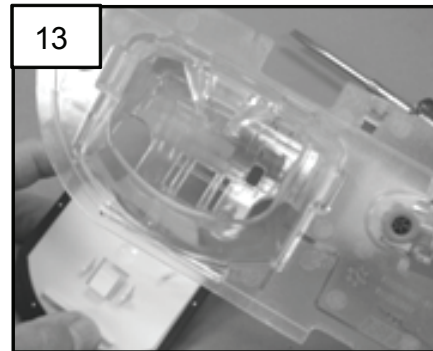

14. To replace a switch, depress the release in the center slot and slide off the switch.

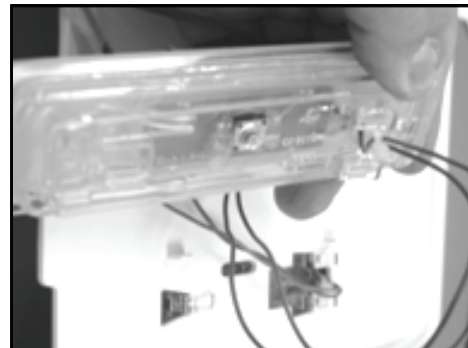
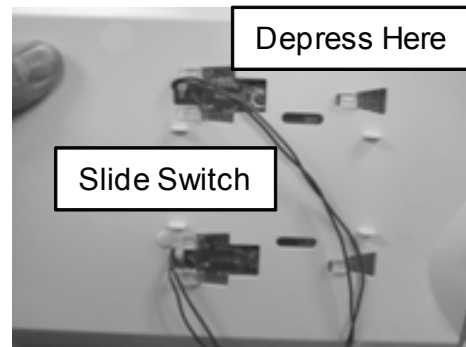

**—NOTES—**

# MACHINE COMPARTMENT

**⚠ WARNING**



**Electrical Shock Hazard**  
**Disconnect power before servicing.**  
**Replace all parts and panels before operating.**  
**Failure to do so can result in death or electrical shock.**

Unplug refrigerator or disconnect power."

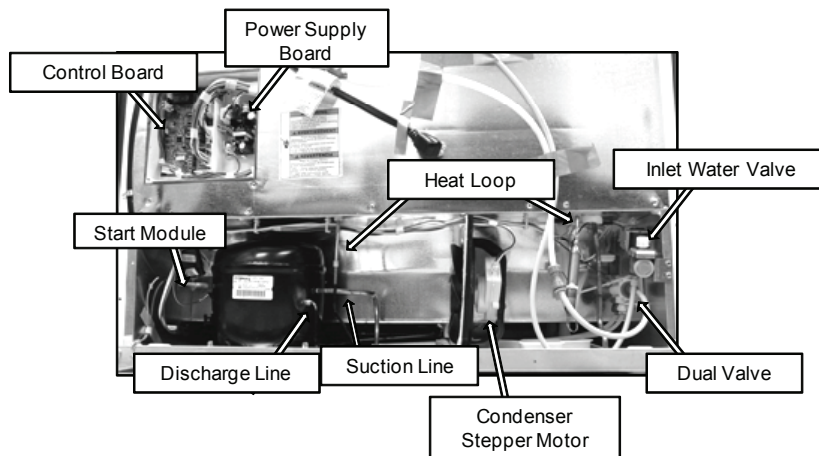
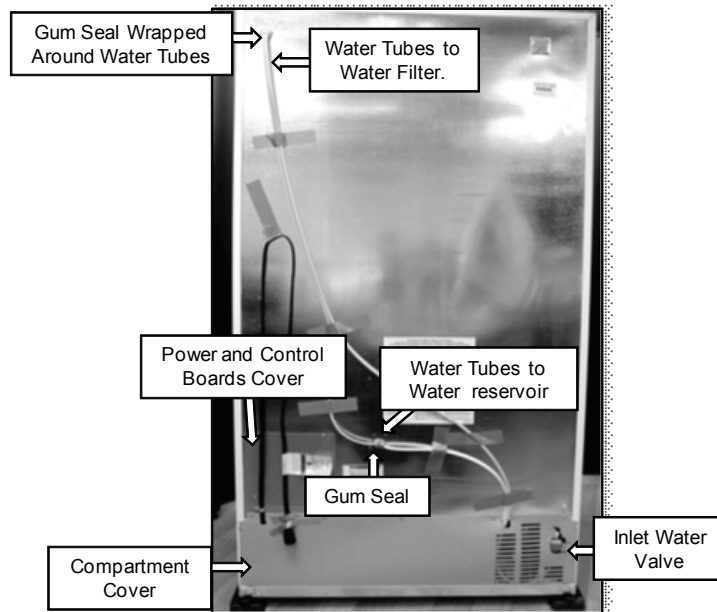

# Machine Compartment Components

**⚠ WARNING**



**Electrical Shock Hazard**  
**Disconnect power before servicing.**  
**Replace all parts and panels before operating.**  
**Failure to do so can result in death or electrical shock.**

1. Disconnect power to the refrigerator.
2. Remove the ¼" screws securing the fiber cover to the cabinet.

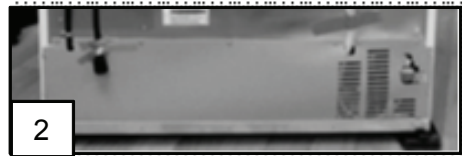

3. To remove the start module remove the bail and unplug the module.

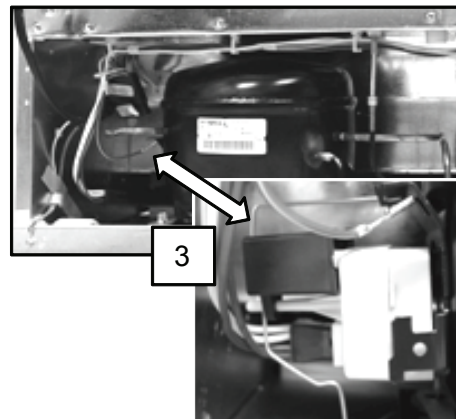

4. Unplug the wire harness.

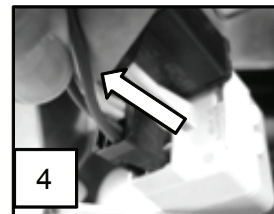

5. The run capacitor unplugs from the module.





# Machine Compartment Components (continued)

## Starting Device Operation

The starting device is an assembly consisting of an overload (1) and a PTC relay (2). The PTC relay is composed of a semi conductive substance formed in the shape of a disk (2). The disk is connected in series with the run and start terminals which in turn connect to the run and start windings. The resistance of the disk material is relatively low at room temperature. When voltage is applied and current flows to the compressor windings, the current flowing to the start winding heats the disk material. As the temperature of the disk increases, the resistance of the disk increases rapidly and limits current flow to the start winding. At the same time current flow through the disk is decreasing, the effects of current flow through the run capacitor increases. This change in current and capacitance seen by the start winding helps start the compressor and allows the start winding to remain in the circuit once the compressor is running.

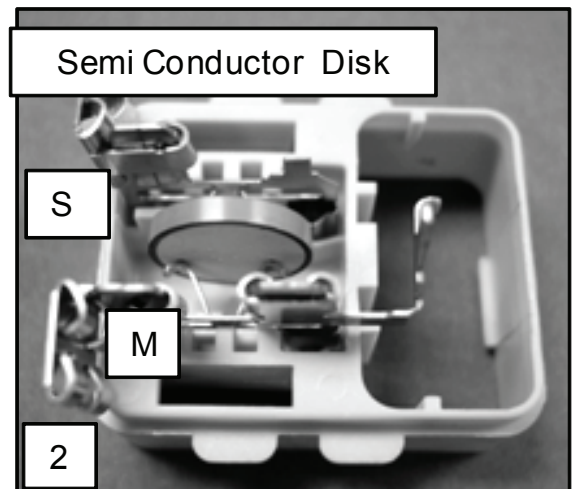
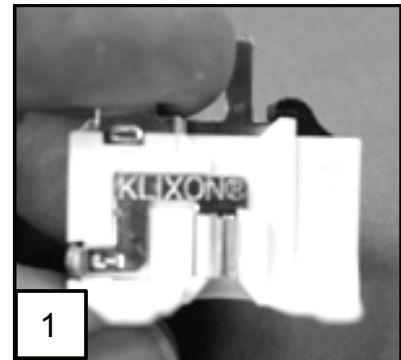

**NOTE:** Do not disassemble the PTC device. The PTC device (2) was opened to show the interior construction and to assist in explaining the theory of operation

Checking the PTC: The easiest way to check the PTC device is to replace it with a known good one. If a new PTC device is not available, a resistance check can be made.

1. Disconnect power to the refrigerator.
2. Disconnect the starting device from the compressor.
3. Unplug the run capacitor from the module.
4. Connect an Ohmmeter across the L and S terminals.
5. If the PTC is at ambient temperature, 70 – 80 degrees F., the approximate resistance should be between 3 and 10 OHMs. An infinite reading indicates the PTC device is open.



## Machine Compartment Components (continued)

Accessing Dual Water Valve: The valve is located in the machine compartment attached to the compartment wall.

To Remove:

<b>⚠ WARNING</b>

<b>Electrical Shock Hazard</b> Disconnect power before servicing. Replace all parts and panels before operating. Failure to do so can result in death or electrical shock.

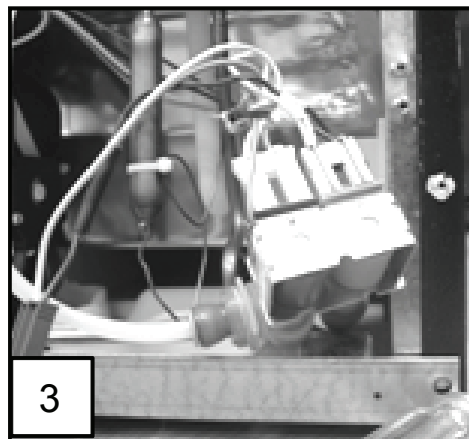
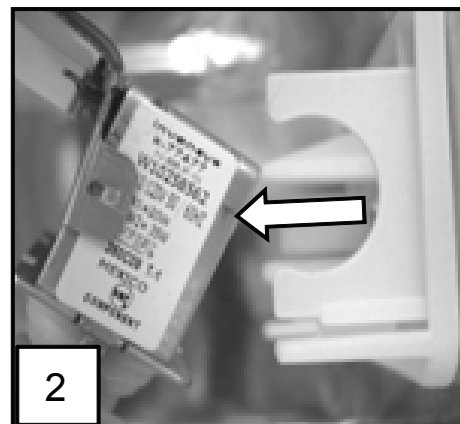
1. Unplug the refrigerator or disconnect power.
2. Unsnap the water valve assembly out of the bracket.
3. Once outside the machine compartment disconnect the water tubes and wire harnesses



## Machine Compartment Components (continued)

Condenser Fan: The condenser fan motor is a step motor and cannot be checked with an Ohmmeter. The condenser fan blade can be pulled off to replace without removing the assembly.

To remove the condenser fan motor:

<b>⚠ WARNING</b>

<b>Electrical Shock Hazard</b> <b>Disconnect power before servicing.</b> <b>Replace all parts and panels before operating.</b> <b>Failure to do so can result in death or electrical shock.</b>

1. Unplug the refrigerator or disconnect power.
2. Pull off the fan blade.
3. Disconnect the wire harness.
4. Remove the screws securing the motor to the mounting bracket and remove

To remove the condenser fan assembly:

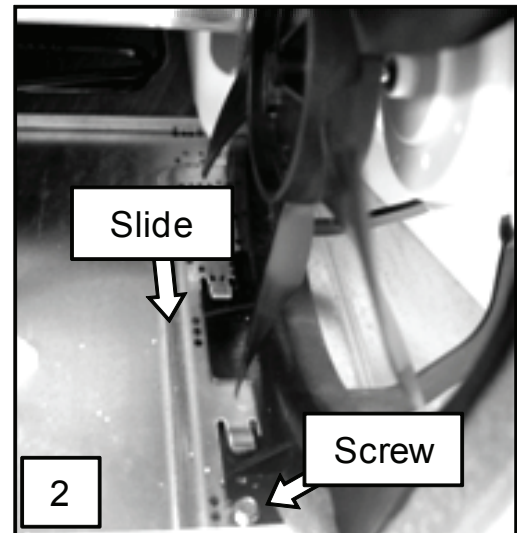
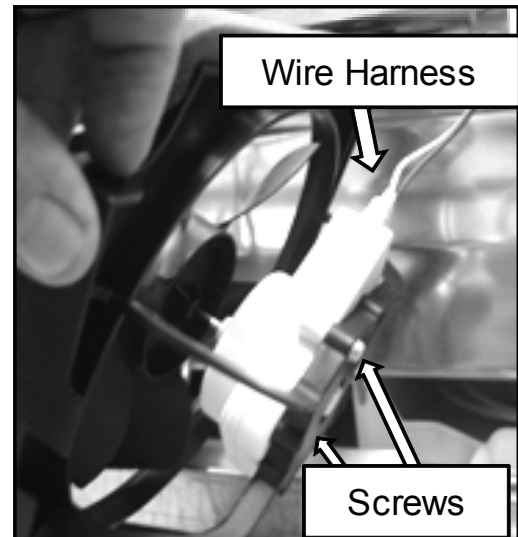
1. Disconnect power to the refrigerator.
2. Remove 1/4" screw and slide the assembly out of the brackets in the base.



## Machine Compartment Components (continued)

### Drain Pan

The drain pan is much larger than anything that has been used recently. It's secured to the bottom of the cabinet with 5 1/4" screws.



# Machine Compartment Components (continued)

## Front Wheel

A center wheel assembly replaces the tradition corner wheel design used on other models.

### **!WARNING**

**Excessive Weight Hazard**  
**Use two or more people to move and install refrigerator.**  
**Failure to do so can result in back or other injury.**

The axle is held in place by a locking clip. The refrigerator must be tilted back to remove.

To remove the wheel:

1. Elevate the front of the refrigerator a few inches so the wheel is off the floor.
2. Remove the axle clip and slide out the axle.
3. Remove the axle and wheels.

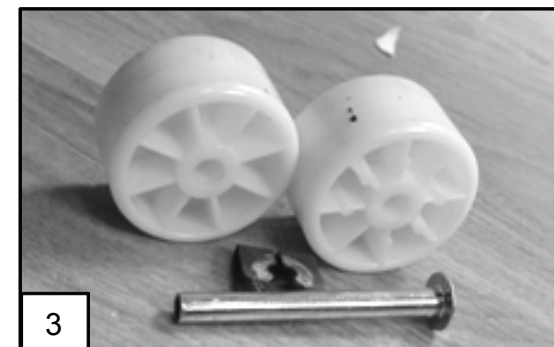
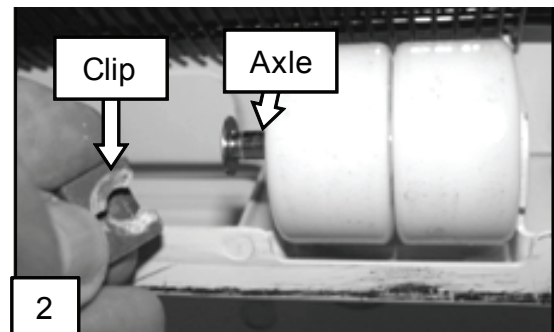
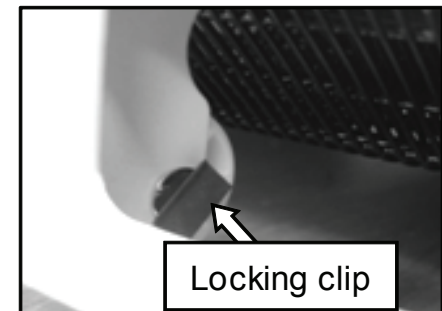
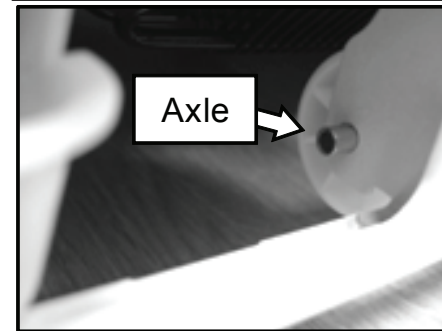
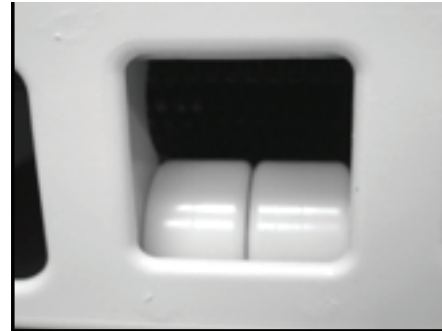

## Machine Compartment Components (continued)

### Control and Power Supply Boards

Similar to existing refrigerators, the control and power supply boards are located behind a cover on the back of the refrigerator.

To access the boards:

**⚠ WARNING**



#### Electrical Shock Hazard

**Disconnect power before servicing.**

**Replace all parts and panels before operating.**

**Failure to do so can result in death or electrical shock.**

1. Disconnect the refrigerator from the power supply.
2. Remove 4 - 1/4" screws securing the cover to the cabinet.
3. Remove the clear cover by unsnapping the latch on the right hand side of the cover.
4. To change a board, disconnect wiring harnesses.
5. Release tabs on right side of the board and lift and slide the board to the right to remove.

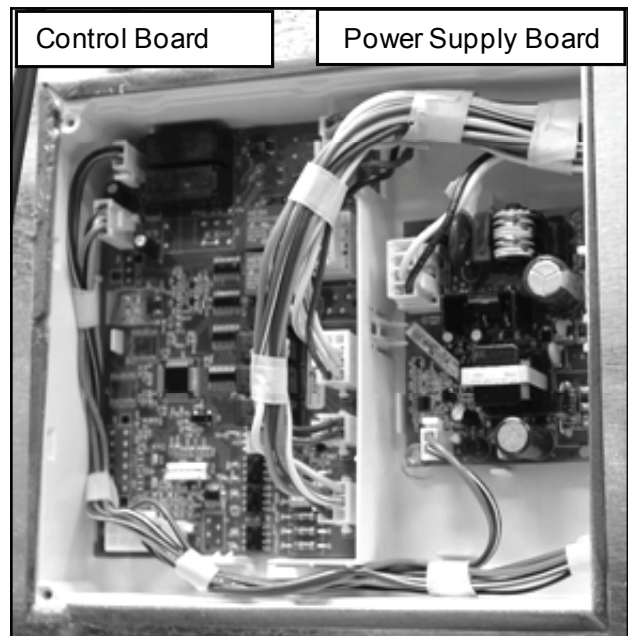
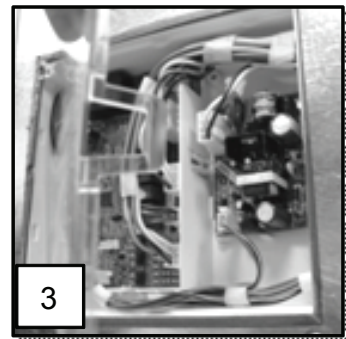

# DIAGNOSTICS, WIRING DIAGRAMS AND TROUBLESHOOTING

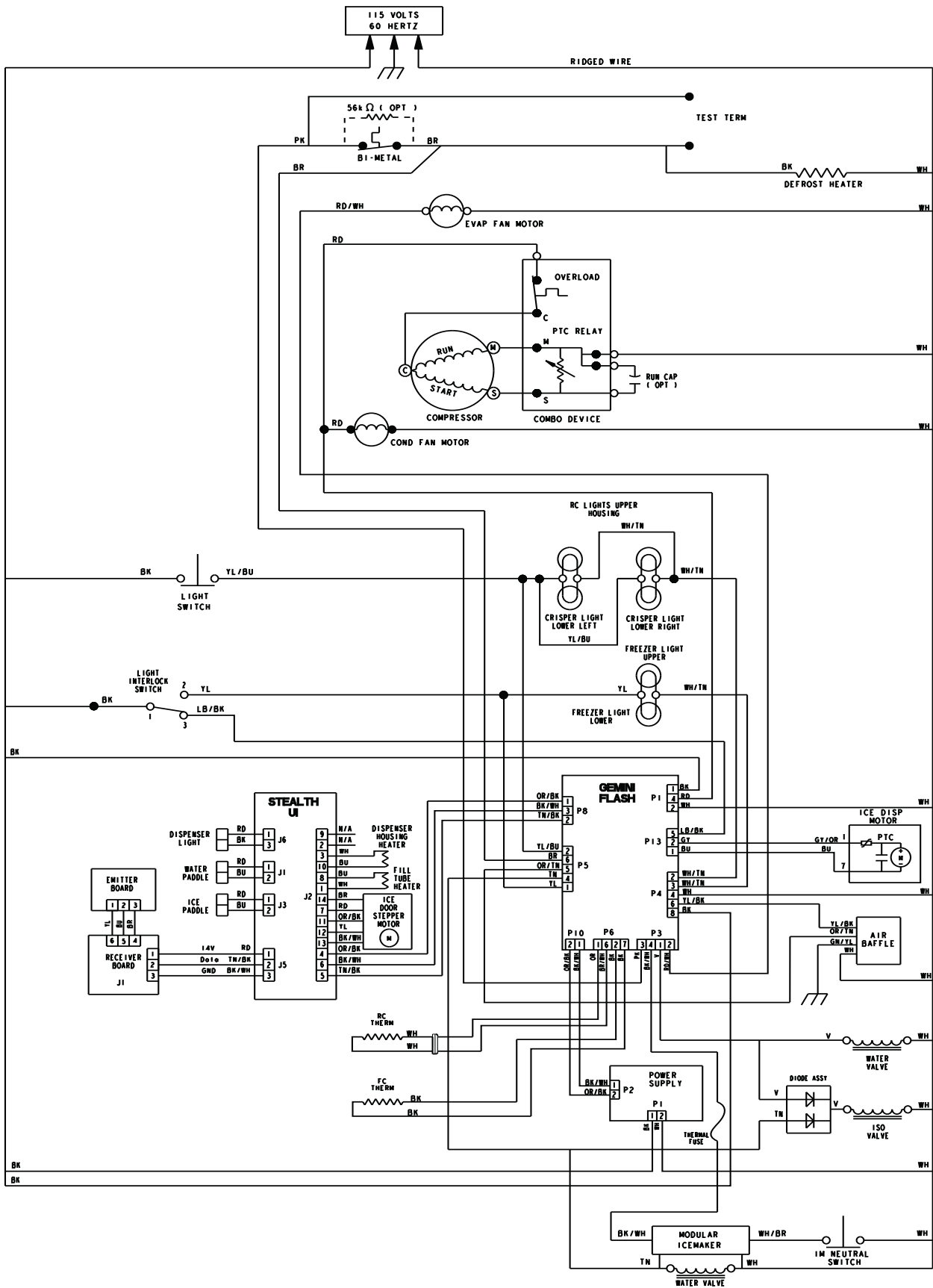

# Diagnostics, Wiring Diagrams And Troubleshooting (continued)

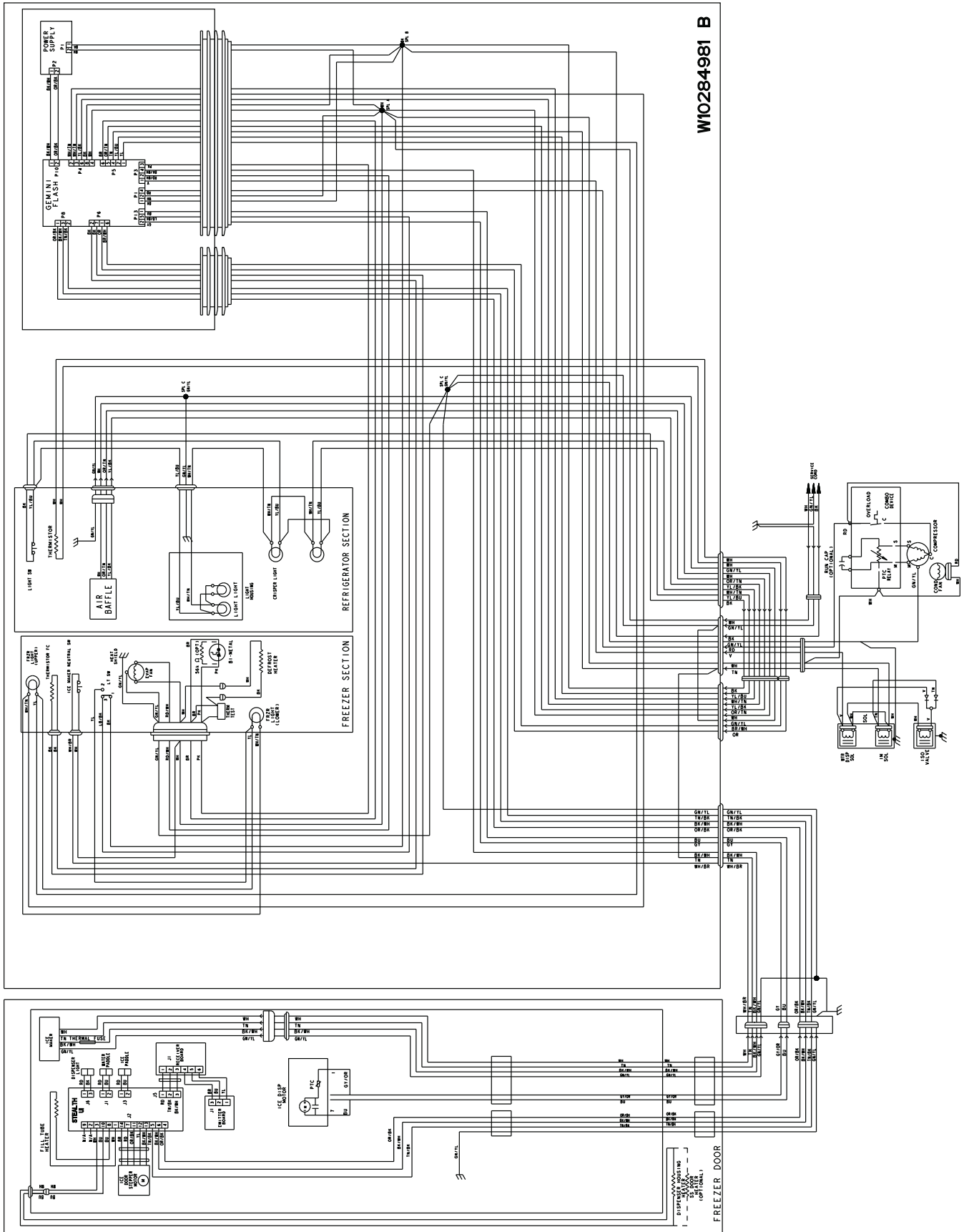





# Diagnosics, Wiring Diagrams And Troubleshooting (continued)

For Service Technician's Use Only

## Voltage Test Points

<b>⚠ DANGER</b>

<p><b>Electrical Shock Hazard</b> Only authorized technicians should perform diagnostic voltage measurements. After performing voltage measurements, disconnect power before servicing. Failure to follow these instructions can result in death or electrical shock.</p>

<b>⚠ WARNING</b>

<p><b>Electrical Shock Hazard</b> Plug into a grounded (earthed) outlet. Replace all parts and panels before operating. Failure to do so can result in death or electrical shock.</p>

## Voltage Measurement Safety Information

When performing live voltage measurements, you must do the following:

- Verify the controls are in the off position so that the appliance does not start when energized.
- Allow enough space to perform the voltage measurements without obstructions.
- Keep other people a safe distance away from the appliance to prevent potential injury.
- Always use the proper testing equipment.
- After voltage measurements, always disconnect power before servicing.

To check for proper voltage, complete the following steps:

1. Disconnect power.
2. Connect voltage measurement equipment.
3. Reconnect power and confirm voltage reading.
4. Disconnect power after performing voltage measurement.

# Diagnostics, Wiring Diagrams And Troubleshooting (continued)

Voltage Test Points (continued)

GEMINI FLASH

		FROM	COLOR	TO	COLOR	
<b>POWER SUPPLY</b>	<b>P1</b>	P1-1	BK	P1-2	WH	120 VAC INPUT - CONSTANT WHEN UNIT PLUGGED IN
	<b>P2</b>	P2-1	BK/WH	P2-2	OR/BK	14 VDC OUTPUT CONSTANT WHEN UNIT PLUGGED IN
<b>MAIN CONTROL</b>	<b>P1</b>	P1-1	BK	P1-2	WH	120 VAC INPUT - CONSTANT WHEN UNIT PLUGGED IN
		P1-2	WH	P1-4	RD	120 VAC OUTOUT TO COMPRESOR /CONDENSER FAN WHEN COOLING
	<b>P3</b>	P3-1	V	P1-2	WH	120 VAC OUTPUT TO WATER DISPENSER VALVE IS ACTIVE
		P3-2	RD/WH	P1-2	WH	120 VAC OUTPUT TO EVAP FAN WHEN COOLING
		P3-3	PK	P1-2	WH	120 VAC OUTPUT TO DEFROST HEATER WHEN ENERGIZED
		P3-4	BK/WH	P1-2	WH	120 VAC OUTPUT TO ICE MAKER
	<b>P4</b>	P4-2	WH/TN	P4-4	WH	120 VAC OUTPUT TO FC LIGHT
		P4-3	WH/TN	P4-4	WH	120 VAC OUTPUT TO RC LIGHT
		P4-4	WH	P1-1	BK	120 VAC INPUT TO FC LIGHT SWITCH
		P4-6	YL/BK	P4-4	WH	120 VAC OUTPUT TO AIR DOOR
	<b>P5</b>	P4-8	BK	P4-4	WH	120 VAC INPUT TO RC LIGHT SWITCH
		P5-1	YL	P1-1	BK	120 VAC INPUT FC LIGHT SWITCH FEEDBACK
		P5-2	YL/BU	P1-1	BK	120 VAC INPUT RC LIGHT SWITCH FEEDBACK
		P5-4	TN	P1-1	BK	120 VAC INPUT ICE MAKER WATER VALVE
		P5-5	OR/TN	P1-1	BK	120 VAC INPUT AIR DOOR FEEDBACK
		P5-6	BR	P1-1	BK	120 VAC INPUT BIMETAL FEEDBACK
	<b>P6</b>	P6-1	OR	P6-6	BR/WH	5 VDC INPUT RC THERMISTOR
		P6-2	BK	P6-7	BK	5 VDC INPUT FC THERMISTOR
	<b>P8</b>	P8-1	OR/BK	P8-3	BK/WH	14 VDC OUTPUT USER INTERFACE
		P8-2		COMMUNICATION		
	<b>P10</b>	P10-1	BK/WH	P10-2	OR/BK	14 VDC OUTPUT CONSTANT WHEN UNIT PLUGGED IN
	<b>P13</b>	P13-1	BU	P13-2	GY	140 VDC OUTPUT TO IDI MOTOR/NON IDI MOTOR IS ACTIVE
		P13-5	LB/BK	P1-1	BK	120 VAC INPUT DOOR SWITCH

## Diagnostics, Wiring Diagrams And Troubleshooting (continued)

VOLTAGE TEST POINTS STEALTH					
J1	J1-1	RD	J1-2	BU	PWM SIGNAL 9.3 V (IS 1/3 DUTY CYCLE OF 14 V- OPEN) / 0 V - THE ICE DISPENSER IS ACTIVE
J2	J2-1	WH	J2-8	BU	14 VDC OUTPUT TO FILL TUBE HEATER
	J2-3	BU	J2-10	WH	14 VDC OUTPUT TO DISPENSER HOUSING HEATER
	J2-4	OR/BK	J2-6	BK/WH	14 VDC INPUT GEMINI FLASH
	J2-5	TN/BK	COMMUNICATION (NOT TESTED)		
J3	J3-1	RD	J3-2	BU	PWM SIGNAL 9.3 V (IS 1/3 DUTY CYCLE OF 14 V- OPEN) / 0 V - THE ICE DISPENSER IS ACTIVE
J5	J5-1	RD	J5-3	BK/WH	14VDC OUTPUT TO LVIDI
J6	J6-1	RD	J6-3	BK	14 VDC OUTPUT DISPENSER LIGHT

VOLTAGE TEST POINTS RECEIVER					
J1	J1-1	RD	J1-3	BK/WH	14 VDC INPUT TO STEALTH BOARD
	J1-2	TN/BK	COMMUNICATION (NOT TESTED)		
	J1-4	BR	J1-3	BK/WH	14 VDC OUTPUT TO EMITTER BOARD
VOLTAGE TEST POINTS EMITTER					
J1	J1-1	BR	J1-3	BK/WH	14 VDC INPUT TO RECEIVER BOARD

# Diagnosics, Wiring Diagrams And Troubleshooting (continued)

For Service Technician's Use Only

<b>⚠ WARNING</b>

<b>Electrical Shock Hazard</b> Disconnect power before servicing. Replace all parts and panels before operating. Failure to do so can result in death or electrical shock.

Unplug refrigerator or disconnect power.

## Thermistor Resistance Table

Temp F	Resistance	Temp F	Resistance
-10	31402	50	5348
-5	26704	55	4687
0	22774	60	4117
5	19476	65	3624
10	16701	70	3197
15	14359	75	2826
20	12378	80	2503
25	10698	85	2221
30	9268	90	1974
40	7007	95	1758
45	6115	100	1569

# Diagnostics, Wiring Diagrams And Troubleshooting (continued)

LIT SERVICE & WIRING SHEET  
W10281957 B

## SERVICE SHEET

W10326488 A



### ⚠ WARNING

**Electrical Shock Hazard**  
Disconnect power before servicing.  
Replace all parts and panels before operating.  
Failure to do so can result in death or electrical shock.

Normal operating conditions are viewed when the air and temperature controls are at mid-setting, freezer section 0 to -5°F and unit is cycling.

NOTE: Watt and pressure readings will vary and are influenced by the existing condition of the appliance, such as iced-up evaporator, condition

of condenser, defrost cycle, pull-down time and customer use.

PERFORMANCE DATA *( NORMAL OPERATING CONDITIONS )				
AMB	WATTS	SYSTEM PRESSURE ( PSIG )		
		HIGH SIDE	LOW SIDE	
70°	140±20	95 ± 20	-7 TO 3	
90°	150±20	135 ± 20	-4 TO 3	
110°	170±20	185 ± 20	-2 TO 4	

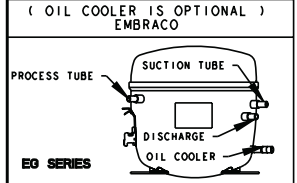

### SERVICE INFORMATION ( W10281960 B )

- COMPRESSOR SUCTION AND PROCESS STUBS MAY NOT BE INTERCHANGED UNLESS INDICATED BY \*\*.
- REFRIGERANT CHARGE MUST BE APPLIED TO HIGH SIDE ONLY.
- ICE MAKER AND WATER VALVE NOT ORIGINAL EQUIPMENT ON ALL MODELS.
- NOTE: ICE MAKER CYCLE MUST BE INITIATED ELECTRICALLY. DO NOT TRY TO MANUALLY START CYCLE.
- SERVICE DEFROST BI-METALS -50°F OPEN.
- PART NUMBER CAN BE FOUND ON THE COMPONENT.

SERVICEABLE ELECTRICAL PARTS MATRIX ( COMPONENTS BY CUBIC FOOT SIZE )					
SERVICEABLE PARTS	20/22 CUBIC FOOT	25, 26 AND 27 CUBIC FT		WATTAGE	RESISTANCE
				120V	
COMPRESSOR		EGYS70	EGX70		
		W10260368	W10200250		
RUN WINDINGS		*			1-5
START WINDINGS		*			3-11
START DEVICE, OVERLOAD		See Note 6			
RUN CAPACITOR ( IF EQUIPPED )		See Note 6			
THERMISTOR		See Note 6			2.7K@77°F, 7.964K@36°F, 23.345K@0°F
MAIN CONTROL ( Unit compartment )		See Note 6			
USER INTERFACE		See Note 6			
BAFFLE MODULE ( OPT )		W10251495 / W10268666			
DEFROST TIMER ( OPT )		See Note 6			
ADAPTIVE DEFROST ** ( OPT )		See Note 6			
ADC/FILTER INDICATOR (OPT)		See Note 6			
DEFROST HEATER		See Note 6		435-465	28-34
DEFROST BI-METAL		See Note 6			
EVAPORATOR FAN		See Note 6		2-9	
CONDENSER FAN		See Note 6		3-12	
** PRIMARY SOURCE PART NUMBER					

### ELECTRONIC CONTROL FEATURES

The dispenser user interface in this appliance controls both the product cooling and the dispensing systems. The product cooling diagnostics are first (see this page) followed by the dispensing diagnostics (see back of this page). The cooling portion of the electronic control in this appliance controls the temperatures in the refrigerator and freezer compartments independently, delays the operation of the evaporator fan, and pulses the defrost heater. The fan delay and pulsed defrost features are controlled in the following manner:

- Evaporator Fan Delay - The electronic control delays the evaporator fan from coming on for 60 seconds after the compressor has turned on, and the evaporator fan stays on for 90 seconds after the compressor has turned off.
- Pulsed Defrost Heat - During the defrost cycle the heater is energized continuously for the first 5 minutes. It is then cycled off for 60 seconds and on for 120 seconds. This on/off cycle is repeated until the bi-metal opens or the maximum defrost time ( 21 minutes ) is reached.

### SERVICE DIAGNOSTICS MODE

To ENTER SERVICE DIAGNOSTICS Mode: Press SW1 and SW2 simultaneously for 3 seconds. Release both buttons when you hear the CHIME indicator. Unit must not be in Lockout prior to entering SERVICE DIAGNOSTIC MODE.

The display will show 01 to indicate the control is in step 1 of the diagnostics routine.

To EXIT SERVICE DIAGNOSTICS Mode, do one of the following 3 options:

- Press SW1 and SW2 simultaneously for 3 seconds.
- Disconnect the product from power.
- Allow 20 minutes to pass.

Following the exit of the diagnostic mode, the controls will then resume normal operation.

Cooling diagnostics are steps 1 through 7. Dispensing diagnostics are steps 8 through 30.

Each step must be manually advanced. Press SW5 to move to the next step in the sequence. Press SW4 to back up in the sequence to the previous step. Diagnostics will begin at Step 1. Each step is displayed in the two digits of the dispenser user interface display. The step results are displayed in the two digits on dispenser user interface display 2 seconds after the step number is displayed. An amber LED will be shown to designate that the step number is being displayed and a red LED will be shown to designate that the status of the step is being displayed. All button and pad inputs shall be ignored and all inputs shall be off, except as described in the actions for each step.

Note: The ice door motor cycles 1 minute after an ice dispensing.

**Service Tip: If the control does not respond, remove power from the entire appliance for 10 seconds. Re-apply power, wait 10 seconds, and perform the service diagnostics routine.**

Step No.	Component Tested	Suggested Diagnostics Routine: COOLING system steps 1-7. DISPENSING system steps 8-30.	Component Status Indicator
1	FC thermistor	This is an internal board test. The board will check the resistance value of the thermistor and display the results on the RC Temp Display.	O1=Pass O2=Open O3=Short
2	RC thermistor	This is an internal board test. The board will check the resistance value of the thermistor and display the results on the RC Temp Display.	
3	Evaporator fan motor and Air baffle motor	Verify air flow from the evaporator fan. Check to see if the baffle opens and closes.	O1=Fan ON, Air Baffle is open O2=Fan ON, Air Baffle is closed (not available on motors without feedback)
4	Compressor/Condenser Fan Motor	Line voltage switched to components from board. Verify 120VAC between line and neutral at motor.	O1=ON O2=OFF
5	N/A	N/A (This step bypassed automatically)	N/A
6	Defrost heater/Bi-metal	Line voltage switched to components from board, verify 120VAC between line and neutral at heater. Under some conditions, the Bi-metal can take a few minutes to close the circuit. Note: If Bi-metal is open, it will need to be by-passed for heater to operate. See Note below.	Blank - Until get a valid reading O1 = Bi-metal Closed O2 = Bi-metal Open
7	Defrost Mode	The Defrost Mode can be set by using SW3. In ADC Mode the product will automatically defrost after a minimum of 8 hours of compressor runtime and up to maximum of 96 hours of compressor runtime, depending upon product usage. In Basic Mode the product will automatically defrost after 8 hours of compressor runtime. The Defrost Mode must be set to ADC ON before exiting the Service Diagnostic Mode. Press SW5 to indicate the completion of this step and to continue with dispenser service routine.	O1 = ADC ON O2 = Basic Mode ON (8 hour timer)

**ATTENTION: IF BI-METAL IS BY-PASSED FOR TESTING ( IF APPLICABLE ), DO NOT OVERHEAT EVAPORATOR AREA.**

LIT-SERVICE  
SHEET NO.

W10326488 A

LIT-SERVICE  
SHEET NO.

W10326488 A

# Diagnostics, Wiring Diagrams And Troubleshooting (continued) SERVICE SHEET

⚠ WARNING

**Electrical Shock Hazard**

**Disconnect power before servicing.**

**Replace all parts and panels before operating.**

**Failure to do so can result in death or electrical shock.**

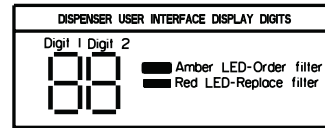

NOTE: The step number is shown first, followed by the status of the step 2 seconds after the step number is displayed. When the step number is being shown, the amber LED will be on. When the status of the step is being shown, the red LED will be on.

SERVICE INFORMATION ( W10326490 A )

## SWITCH DIAGRAM



Step #	Component Tested	Suggested Diagnostics Routine: COOLING system steps 1-7. DISPENSING system steps 8-30.	Component Status Indicator																								
8	All UI indicators	Verify that all LED indicators and UI display digits turn on automatically.	All indicators ON																								
9	UI Button and Pad Test	Displays the User Interface Buttons and Ice and Water Pads status as described in the Component Status Indicator column.  NOTE: Do not use SW4 and SW5 as these are used only to navigate through the Service Diagnostics.	<table style="width: 100%; border: none;"> <tr> <td style="width: 10%;">Digit 1</td> <td style="width: 10%;">Digit 2</td> <td style="width: 80%;"></td> </tr> <tr> <td>1</td> <td>0</td> <td>SW1 Pressed</td> </tr> <tr> <td>2</td> <td>0</td> <td>SW2 Pressed</td> </tr> <tr> <td>3</td> <td>0</td> <td>SW3 Pressed</td> </tr> <tr> <td>6</td> <td>0</td> <td>SW6 Pressed</td> </tr> <tr> <td>0</td> <td>1</td> <td>Ice Pad Pressed</td> </tr> <tr> <td>0</td> <td>2</td> <td>Water Pad Pressed</td> </tr> <tr> <td>0</td> <td>3</td> <td>Ice and Water Pads Pressed</td> </tr> </table> <p>NOTE: SW4 and SW5 ARE USED FOR NAVIGATION AND ARE NOT DISPLAYED.</p>	Digit 1	Digit 2		1	0	SW1 Pressed	2	0	SW2 Pressed	3	0	SW3 Pressed	6	0	SW6 Pressed	0	1	Ice Pad Pressed	0	2	Water Pad Pressed	0	3	Ice and Water Pads Pressed
Digit 1	Digit 2																										
1	0	SW1 Pressed																									
2	0	SW2 Pressed																									
3	0	SW3 Pressed																									
6	0	SW6 Pressed																									
0	1	Ice Pad Pressed																									
0	2	Water Pad Pressed																									
0	3	Ice and Water Pads Pressed																									
10	N/A	N/A (This step is bypassed automatically)	N/A																								
11	Dispenser Lighting	Pressing SW3 will change the dispenser lighting setting from OFF(0%) to ON(100%) To DIM(50%)	Blank																								
12	N/A	N/A (This step is bypassed automatically)	N/A																								
13	Dispenser Housing Heater Status	Displays the Dispenser Housing Heater status on the UI display. Press SW3 to change status.	O1 = ON O2 = OFF																								
14	Ice Chute Heater Status	Control the Ice Chute Heater using the Change Setting key (toggle between On and Off).	O1 = ON, O2 = OFF																								
15	Ice Level Sensor (LV-IDI)	Reads the Ice Bin Status.	O1 = BIN_FULL_OR_NOT_PRESENT O2 = BIN_NOT_FULL_AND_PRESENT																								
16	RC Door Switch Input	Displays the RC Door status in realtime on the UI display. Verify that the open and close status display correctly.	O1 = RC Door Open O2 = RC Door Closed																								
17	FC Door Switch Input	Displays the FC Door status in realtime on the UI display. Verify that the open and close status display correctly.	O1 = FC Door Open O2 = FC Door Closed																								
18	Ice Door Motor	Displays the Ice Door stepper motor state on the UI display. Initiate ice dispense and verify that the mechanical operation of the ice door corresponds to the component status indicator. NOTE: Ice door will have a delay in closing after an ice dispense is initiated.	O1=Closed, O2=Opening, O3=Open, O4=Closing																								
19	Fill tube heater status	If this feature is available on the product, this step will allow the fill tube heater to be toggled on and off through the use of SW3.	O1=ON, O2=OFF																								
20	Water Filter Usage Rating	Displays in two sequential flashes the total water usage rating in gallons for the water filter on the UI display. Wait until dash is displayed which means end of the number.	00/0- to 99/9-																								
21	Water Filter Time Rating	Displays in two sequential flashes the total time rating in days for the water filter on the UI display. Wait until dash is displayed which means end of the number.	00/0- to 99/9-																								
22	Water Filter Usage	Displays in two sequential flashes the current water filter status in gallons used since last reset on the UI display. Wait until dash is displayed which means end of the number.	00/0- to 99/9-																								
23	Water Filter Time	Displays in two sequential flashes the current water filter status in days since last reset on the UI display. Wait until dash is displayed which means end of the number.	00/0- to 99/9-																								
24	Water Filter Reset	Display in two sequential flashes the current times the Water Filter was reset on the UI display. Wait until dash is displayed which means end of the number.	00/0- to 99/9-																								
25	Water Dispensing and icemaker fill test.	Simulate an icemaker fill. Then the ice maker will show icemaker fill status. Press the Water Pad to initiate the water dispense.	<table style="width: 100%; border: none;"> <tr> <td style="width: 50%; text-align: center;">Digit 1</td> <td style="width: 50%; text-align: center;">Digit 2</td> </tr> <tr> <td>O = Icemaker valve OFF</td> <td>O = Water valve OFF</td> </tr> <tr> <td>I = Icemaker valve ON</td> <td>I = Water valve ON</td> </tr> </table>	Digit 1	Digit 2	O = Icemaker valve OFF	O = Water valve OFF	I = Icemaker valve ON	I = Water valve ON																		
Digit 1	Digit 2																										
O = Icemaker valve OFF	O = Water valve OFF																										
I = Icemaker valve ON	I = Water valve ON																										
26	Main Control Software Version	Displays in three sequential flashes the Main Control software version on the UI display. Note: This is repeated displayed during all time in this step.	00/00/00 to 99/99/99																								
27	Dispenser UI Control Software Version	Displays in three sequential flashes the Dispenser UI Control software version on the UI display. Note: This is repeated displayed during all time in this step.	00/00/00 to 99/99/99																								
28	N/A	N/A (This step is bypassed automatically)	N/A																								
29	Low Voltage IDI SW Version.	Reads the LV-IDI SW Version.	XX XX XX																								
30	N/A	N/A (This step is bypassed automatically)	N/A																								

# **PRODUCT SPECIFICATIONS AND WARRANTY INFORMATION SOURCES**

***IN THE UNITED STATES:***

**FOR PRODUCT SPECIFICATIONS AND WARRANTY INFORMATION CALL:**

**FOR WHIRLPOOL PRODUCTS: 1-800-253-1301**

**FOR KITCHENAID PRODUCTS: 1-800-422-1230**

**FOR ROPER PRODUCTS: 1-800-447-6737**

**FOR TECHNICAL ASSISTANCE WHILE AT THE CUSTOMER'S HOME CALL:**

**THE TECHNICAL ASSISTANCE LINE: 1-800-253-2870**

**HAVE YOUR STORE NUMBER READY TO IDENTIFY YOU AS AN  
AUTHORIZED SERVICER**

**FOR LITERATURE ORDERS:**

**PHONE: 1-800-851-4605**

**FOR TECHNICAL INFORMATION AND SERVICE POINTERS:**

**[www.servicematters.com](http://www.servicematters.com)**

---

***IN CANADA:***

**FOR PRODUCT SPECIFICATIONS AND WARRANTY INFORMATION CALL:**

**1-800-461-5681**

**FOR TECHNICAL ASSISTANCE WHILE AT THE CUSTOMER'S HOME CALL:**

**THE TECHNICAL ASSISTANCE LINE: 1-800-488-4791**

**HAVE YOUR STORE NUMBER READY TO IDENTIFY YOU AS AN  
AUTHORIZED SERVICER**

