



LG

REFRIGERATOR

SERVICE MANUAL

CAUTION
BEFORE SERVICING THE UNIT,
READ THE SAFETY PRECAUTIONS IN THIS MANUAL.

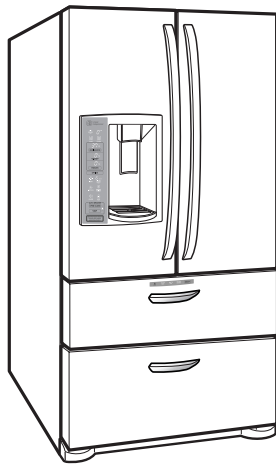

MODEL : LMX28994**

COLOR : STAINLESS(ST)

CONTENTS

SAFETY PRECAUTIONS	2
1. SPECIFICATIONS	3
2. PARTS IDENTIFICATION	4
3. DISASSEMBLY	5-21
REMOVING AND REPLACING REFRIGERATOR DOORS	5
DOOR	6
DOOR ALIGNMENT	7
GRILLE ASSEMBLY	7
FAN AND FAN MOTOR	7
DEFROST CONTROL ASSEMBLY	8
LAMP	8
MULTI DUCT	8
MAIN PWB	9
DISPENSER	9
ICE BUTTON ASSEMBLY	9
WATER BUTTON ASSMEBLY	10
ICE CORNER DOOR REPLACEMENT	10
ICEMAKER REPLACEMENT	10
SUB PWB FOR WORKING DISPENSER	11
CAP DUCT MOTOR REPLACEMENT	11
HOW TO REMOVE A ICE BIN	12
HOW TO INSERT A ICE BIN	12
HOW TO REPLACE THE CONVERTA DISPLAY	13
HOW TO REPLACE THE CONVERTA JOINT	14-15
HOW TO REPLACE THE AUTO DRAWER MOTOR	16-17
HOW TO REPLACE THE AUTO DRAWER JOINT	17-19
WATER VALVE DISASSEMBLY METHOD	20
FAN AND FAN MOTOR DISASSEMBLY METHOD	20
TOP DRAWER	21
BOTTOM DRAWER	21
4. ADJUSTMENT	22-24
COMPRESSOR	22
INTRODUCTION OF E-LINEAR COMPRESSOR	22-24
5. CIRCUIT DIAGRAM	25
6. TROUBLESHOOTING	26-50
7. REFERENCE	51-56
8. COMPONENT TESTING INFORMATION	57-64
9. TROUBLESHOOTING	65- 71
10. ICEMAKER OPEARTING AND TROUBLE SHOOTING METHOD	72-75
11. DESCRIPTION OF FUNCTION & CIRCUIT OF MICOM	76-79
12. EXPLODED VIEW & REPLACEMENT PARTS LIST	80-86

SAFETY PRECAUTIONS

Please read the following instructions before servicing your refrigerator.

1. Unplug the power before handling any elctrical componets.
2. Check the rated current, voltage, and capacity.
3. Take caution not to get water near any electrical components.
4. Use exact replacement parts.
5. Remove any objects from the top prior to tilting the product.

1. SPECIFICATIONS

1-1 LMX28994**

● 28 cu.ft.

ITEMS	SPECIFICATIONS
DOOR DESIGN	Side Rounded
DIMENSIONS (inches)	35 3/4 X 35 3/8 X 69 3/4 (WXDXH) 27cu.ft.
NET WEIGHT (pounds)	175 kg. (386 lb)
COOLING SYSTEM	Fan Cooling
TEMPERATURE CONTROL	Micom Control
DEFROSTING SYSTEM	Full Automatic
	Heater Defrost
DOOR FINISH	PCM, VCM, Stainless
HANDLE TYPE	Bar
INNER CASE	ABS Resin
INSULATION	Polyurethane Foam

ITEMS	SPECIFICATIONS	
VEGETABLE TRAY	Clear Drawer Type	
COMPRESSOR	Linear	
EVAPORATOR	Fin Tube Type	
CONDENSER	Spiral Condenser	
REFRIGERANT	R-134a (215 g)	
LUBRICATING OIL	ISO10 (280 ml)	
DEFROSTING DEVICE	SHEATH HEATER	
LAMP	REFRIGERATOR	LED Module(24)
	CONVERTA	LED Module(12)
	FREEZER	LED Module(12)

DIMENSIONS

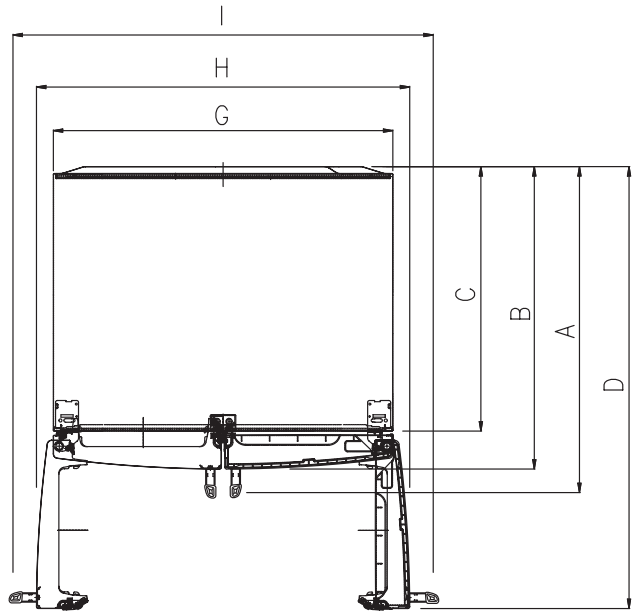
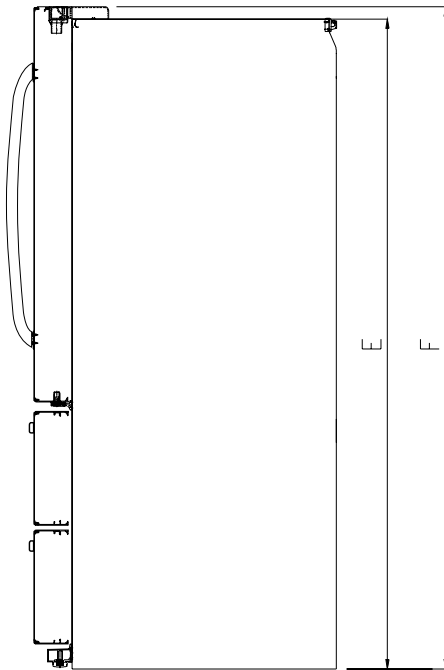

Description		LMX28994**
Depth w/ Handles	A	35 3/8 in
Depth w/o Handles	B	32 7/8 in
Depth w/o Door	C	29 in
Depth (Total with Door Open)	D	47 5/8 in
Height to Top of Case	E	68 3/8 in
Height to Top of Door Hinge	F	69 3/4 in
Width	G	35 3/4 in
Width (door open 90 deg. w/o handle)	H	39 1/4 in
Width (door open 90 deg. w/ handle)	I	44 1/4 in

2. PARTS IDENTIFICATION

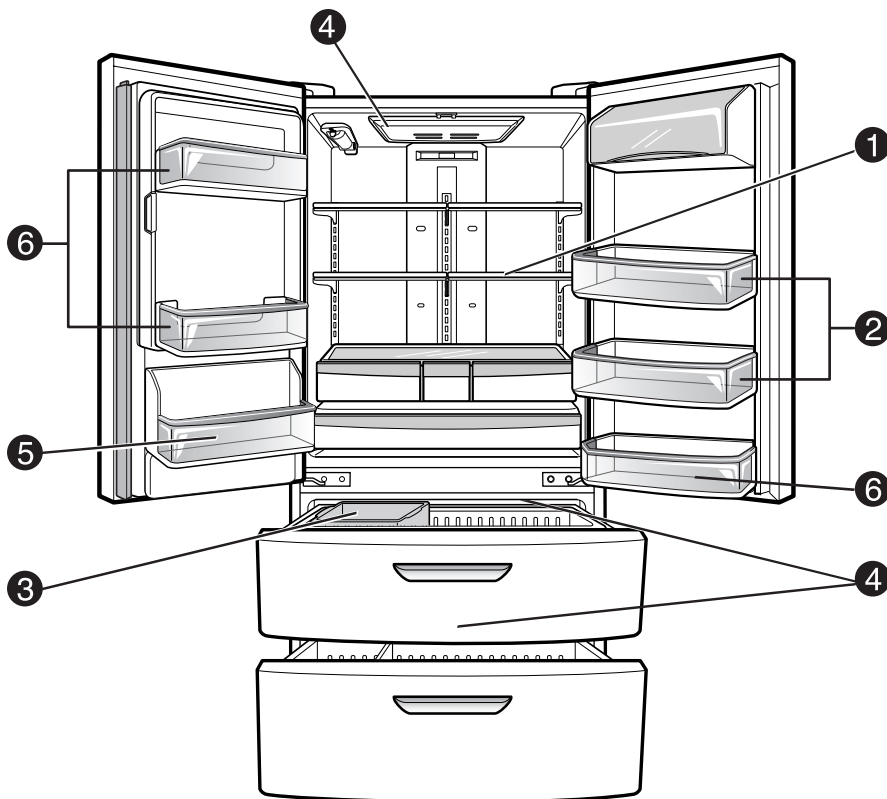

1 ADJUSTABLE REFRIGERATOR SHELVEING

The refrigerator compartment shelves are adjustable to allow flexibility for storage needs.

2 GALLON STORAGE BINS

Two interchangeable bins can be arranged to suit your storage needs.

3 REMOVABLE ICE STORAGE BIN

The ice storage bin can be removed to fill ice buckets, coolers, or pitchers.

4 LED INTERIOR LAMPS

Three separate LED arrays light the freezer and refrigerator interiors.

5 CAN STORAGE BIN

6 FIXED DOOR BINS

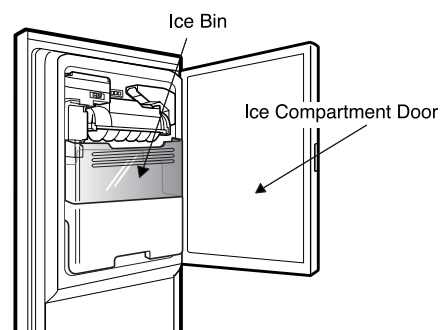

3. DISASSEMBLY

3-1 REMOVING AND REPLACING REFRIGERATOR DOORS

● Removing Refrigerator Door

▲ **CAUTION:** Before you begin, unplug the refrigerator. Remove food and bins from doors.

▶ Left Door -FIG. 2

1. Disconnect water supply tube by pushing back on the disconnect ring (3).-FIG. 1
2. Open door. Loosen top hinge cover screw (1).
- Use flat tip screwdriver to pry back hooks on front underside of cover (2). Lift up cover.
3. Disconnect door switch wire harness and remove the cover.
4. Pull out the tube.
5. Disconnect all 3 wiring harnesses (4). Remove the grounding screw (5).
6. Rotate hinge lever (6) counterclockwise. Lift top hinge (7) free of hinge lever latch (8).

▲ **CAUTION:** When lifting hinge free from the latch, be careful that door does not fall forward.

7. Lift door from middle hinge pin and remove door.
8. Place the door with the insides facing up, on a not scratch surface.

▶ Right Door -FIG. 3

1. Open the door, remove 1 screw on the top of the hinge cover. Loosen top hinge cover screw (1). Lift up cover (2).
2. Disconnect wire harnesses and remove the cover.
3. Rotate hinge lever (3) clockwise. Lift top hinge (4) free of hinge lever latch (5).
4. Lift door from middle hinge pin and remove door.

▲ **CAUTION:** When lifting hinge free from the latch, be careful that the door does not fall forward.

5. Place the door with the insides facing up, on a not scratch surface.

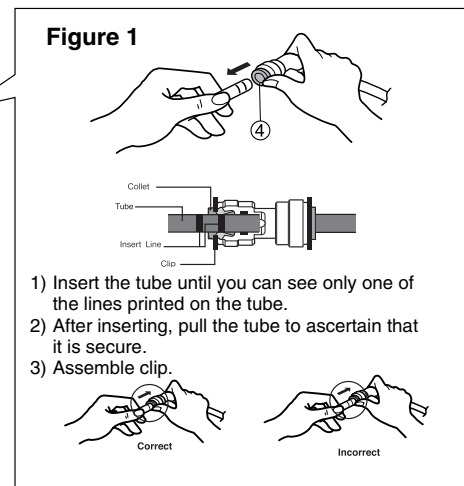
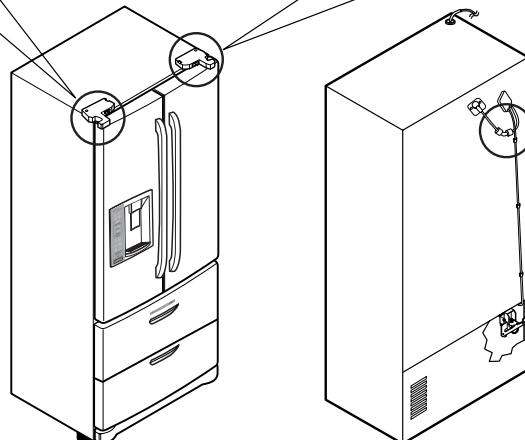
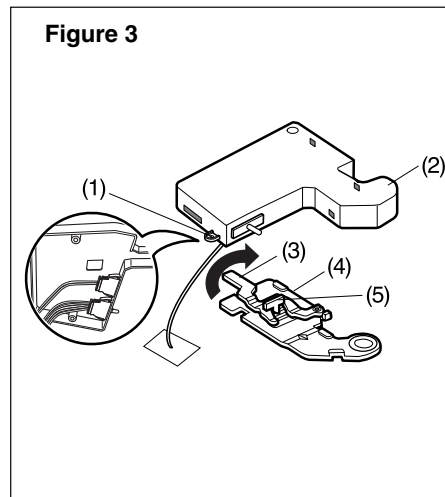
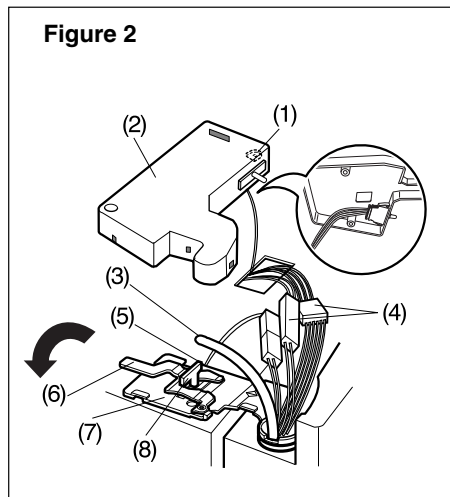

3-2 DOOR

● Mullion Removal

1. Remove 2 screws.



2. Lift Mullion up carefully.



3. Disconnect wire harness.

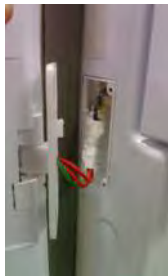

● Door Gasket Removal

1. Remove gasket

Pull gasket free from gasket channel on the four remaining sides of door.

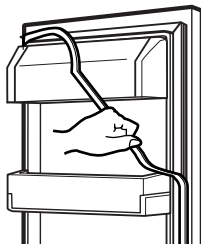

● Door Gasket Replacement

1. Insert gasket into channel

Press gasket into channels on the four remaining sides of door.

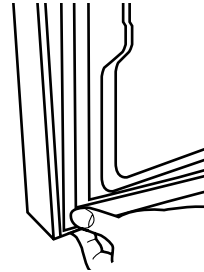

● Mullion Replacement

1. Connect wire harness.



2. Insert mullion into the channel.

Insert the cover assembly into bracket, door.



3. Assemble 2 screws.



3-3 Door Alignment

If the space between the door are uneven, follow the instructions to align them.

Remove the Base Grillie. Turn the leveling legs counter clock wise to raise or clock wise to lower the height of the front of the refrigerator by using flat blade screw driver or 11/32" wrench. Use the wrench (Included with the User Manual) to adjust the bolt in the door hinge to adjust the height. (CCW to raise or CW to lower the height.)

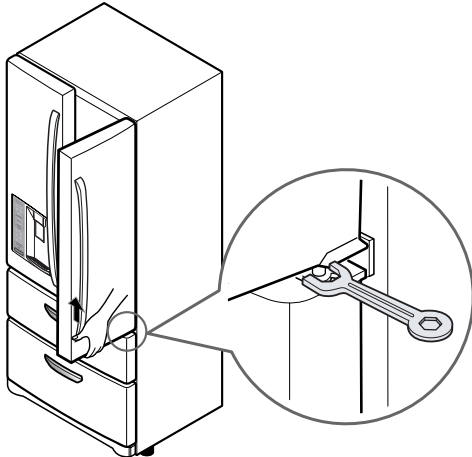

(5)



(6)



(7)



(8)



(9)



(10)

3-4 GRILLE ASSEMBLY

1. Remove the converta drawer. (See p. 14)
2. Remove the center plate by removing 2 screws and pull the center plate.(1),(2)
3. Lift the front of the barrier up and remove the harness.(3),(4)
4. Remove the freezer drawer. (See p.16)
5. Remove the guide rail of the converta drawer. (Each guide rail has one harness.) (5),(6)
6. Remove the guide rail of the freezer drawer. (Each guide rail has one harness.) (7),(8)
7. Using the tool like the thick wrench pull on the grille assembly to remove.(9),(10)
8. Disconnect the wiring harnesses.



(1)



(2)



(3)



(4)

3-5 FAN AND FAN MOTOR

1. Remove the Fan Motor assembly by loosening 3 screws.
2. Pull out the fan and separate the FAN Motor and Bracket.

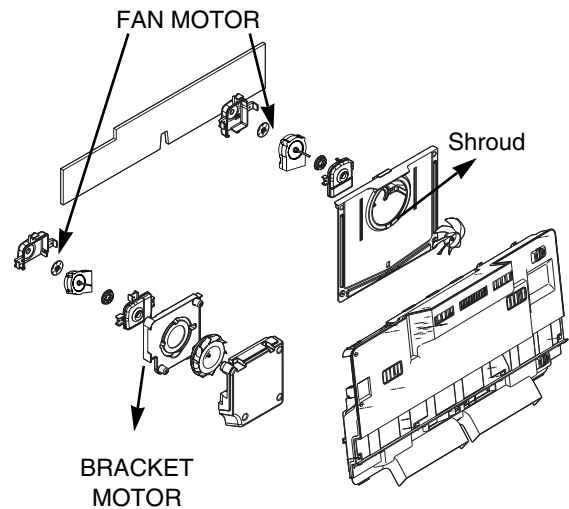

3-6 DEFROST CONTROL ASSEMBLY

Defrost Control assembly consists of Defrost Sensor and FUSE-M.

The Defrost Sensor works to defrost automatically. It is attached to the metal side of the Evaporator and senses its temperature. At 46F(8°C), it turns the Defrost Heater off. Fuse-M is a safety device for preventing over-heating of the Heater when defrosting.

1. Pull out the grille assembly. (Figure 1)
2. Separate the connector with the Defrost Control assembly and replace the Defrost Control assembly after cutting the Tie Wrap. (Figure 2)

GRILLE ASSEMBLY

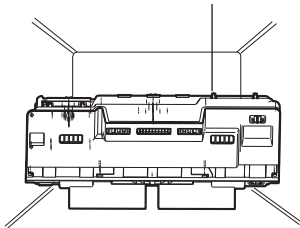

Figure 1

DEFROST-CONTROL ASSEMBLY

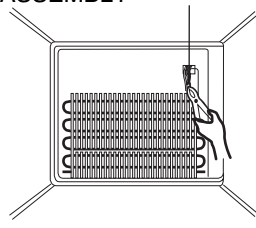

Figure 2

3-7 LAMP

Unplug, or disconnect power at the circuit breaker. If necessary, remove top shelf or shelves.

3-7-1 Refrigerator Compartment Lamp

- 1) Release 2 screws.
- 2) Hold both ends and pull down to remove.



- 3) To remove the lamp case and cover, release 2 screws as shown.



- 4) Use a flat tool as shown below to remove the lamp cover.



- 5) To remove the LED assembly, pull apart the cover.

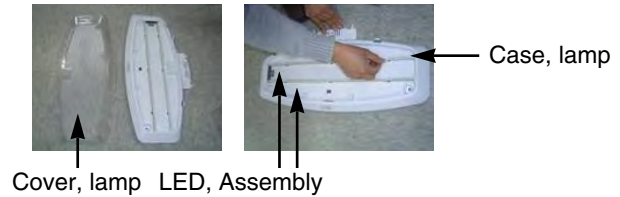

3-7-2 Converta and Freezer Compartment Lamp

1. Unplug refrigerator power cord from outlet.
2. Remove screw with driver.
3. Grasp the cover Lamp, pull the cover downward.



3-8 MULTI DUCT

1. Remove the upper and lower caps with a flat screwdriver and remove 2 screws. (Figure 3)
2. Disconnect the lead wire on the bottom position.

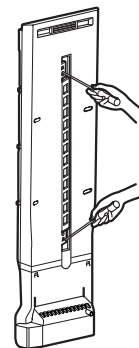

Figure 3

3-9 MAIN PWB

1) Loosen 3 screws on the PWB cover.



2) Remove the PWB cover



3) Disconnect wire harness and replace the main PWB in the reverse order of removal.



4) Holding the inner side of the dispenser pull forward to remove.



5) Remove the lead wire.

▲ CAUTION: When replacing the dispenser cover make sure the lead wire does NOT come off and the water line is not pinched by the dispenser.



3-11 ICE BUTTON ASSEMBLY

- 1) Remove the 1 screw holding the lever.
- 2) Remove the spring from the hook.
- 3) Push and pull on the tab to remove.



Button Lever



3-10 DISPENSER



1) Pull out the drain

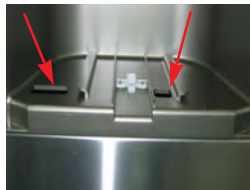

2) Use these 2 holes to pull out the bottom



3) If nozzle is interfered with button, push and pull out the bottom of button and then pull out the right side.

3-12 WATER BUTTON ASSMEBLY

- 1) Remove screws.
- 2) Grasp the Button assembly and lift.

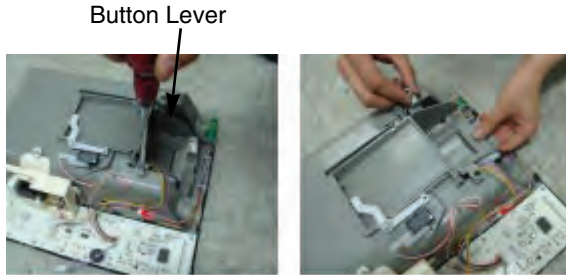

3-14 ICEMAKER REPLACEMENT

- 1) Remove 4 screws as shown.



- 2) Grasp the bottom of motor cover assembly and pull slowly.



3-13 ICE CORNER DOOR REPLACEMENT

- 1) Loosen the front screw as shown in the picture.
- 2) Lift up the hinge with one hand.
- 3) Pull out the Ice Corner Door with the other hand.



- 3) Disconnect wire harness from wall of compartment.

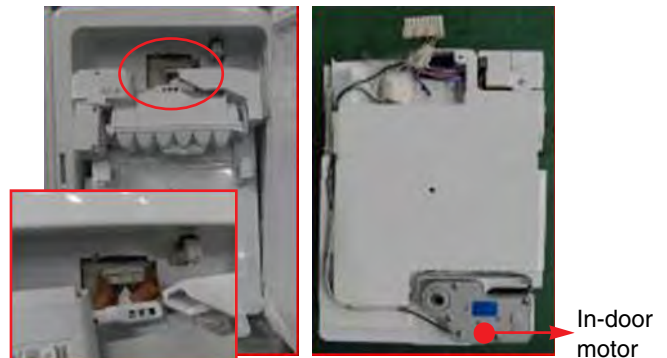

▲ CAUTION: Make sure that the motor housing is taped to the mold, if not positioned correctly the cover will not fit properly.



3-16 CAP DUCT MOTOR REPLACEMENT

1) Separate the Housing of the Cap Duct Motor.



2) Unscrew 3 screws to disassemble the motor.

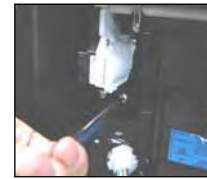

3-15 SUB PWB FOR WORKING DISPENSER

1) Disconnect the wire harness.



2) Remove 1 screw from PWB and replace with new PWB.



3) When replacing the motor, check the position of the door duct and the link for proper fit.

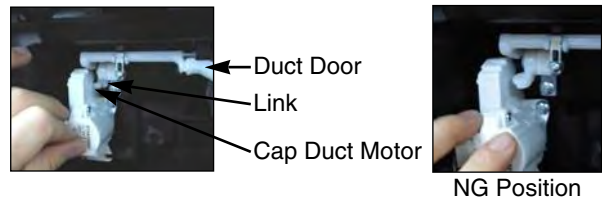

4) Insert 2 screws.



5) Push housing aside.



3-17 HOW TO REMOVE A ICE BIN

1) Grip the handles, as shown.

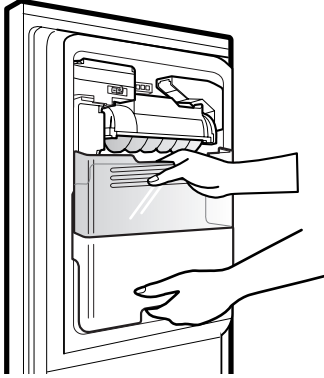

2) Tilt and lift slightly as shown.

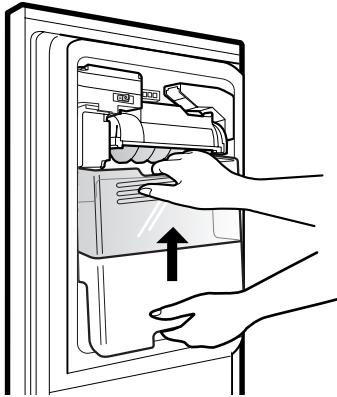

3) Remove ice bin slowly.

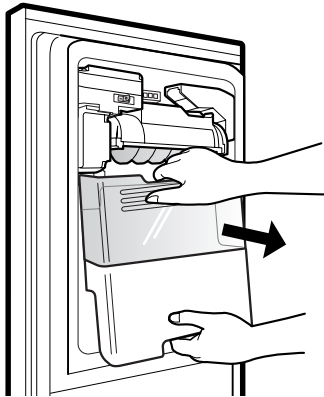

3-18 HOW TO INSERT A ICE BIN

1) Insert the Ice Bin, slightly tilting to avoid touching the Icemaker. (Especially, Ice-Detecting Sensor)

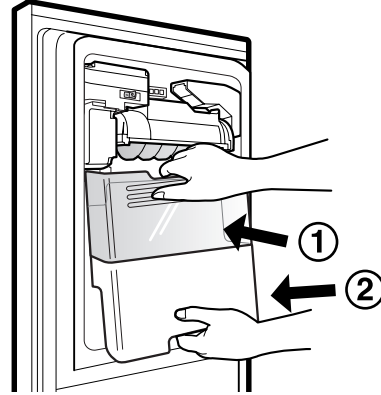

3-19 HOW TO REPLACE THE CONVERTA DISPLAY

3-19-1 Disassembly

- 1) Attach tape PETP on the door.
(Lower part of display. To protect Scratch)



- 2) Disassemble display's lower portion to using tool.



- 3) Disconnect lead wire from display.



3-19-2 Assembly

- 1) Connect lead wire from display



- 2) Pre-Assemble display's top portion department



- 3) Assembly display;s side portion department



- 4) Detach tape PETP



3-20 HOW TO REPLACE THE CONVERTA JOINT

1) Open the Converta drawer.



2) Remove the drawer.



3) Remove the motor cover.

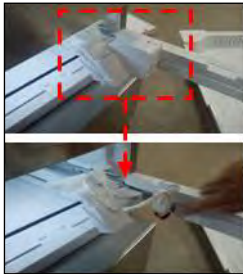

4) Remove the Auto Drawer Joint Housing



5) Remove screws of Guide rail(each one in the both side).



6) Lift the door to disassemble.



7) Using any sharp things such as drill, take out the gear in pressing the right rail clip.

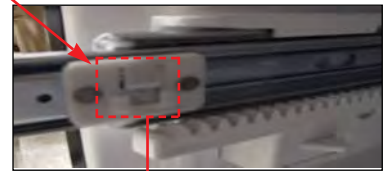
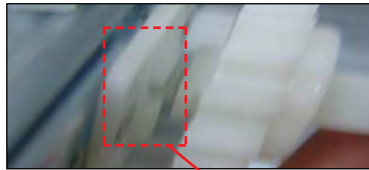

Clip

8) Pull out rail to disassemble in pressing the rail stopper.

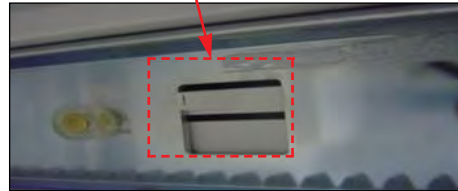

9) Take it out after disassembling the Holder rail screws (3 pcs).

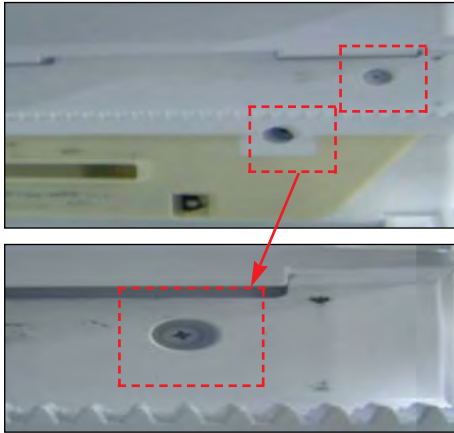

10) Take it out by pressing the hook of auto drawer joint housing by hands.

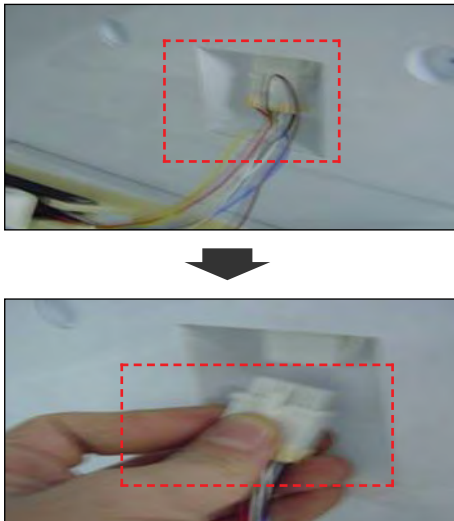

11) Pull out the Holder rail inner link by hands.

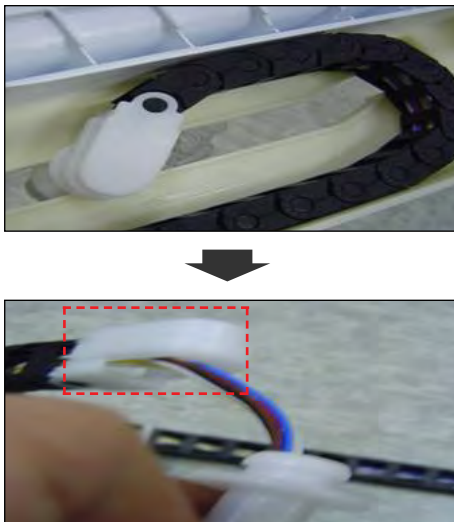

12) Take off the Holder rail fix connector.

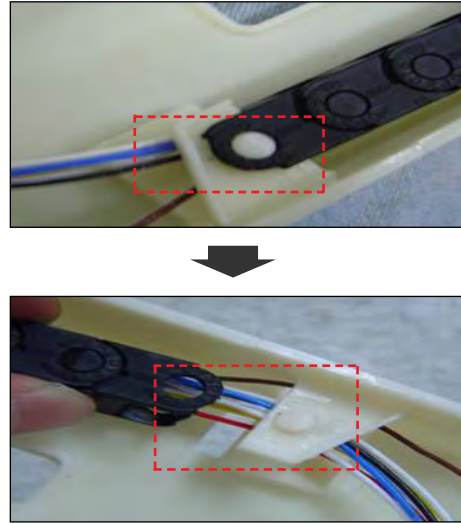

13) Pull out the support holder to the rear hole.
- Pull out the stopper part strongly.

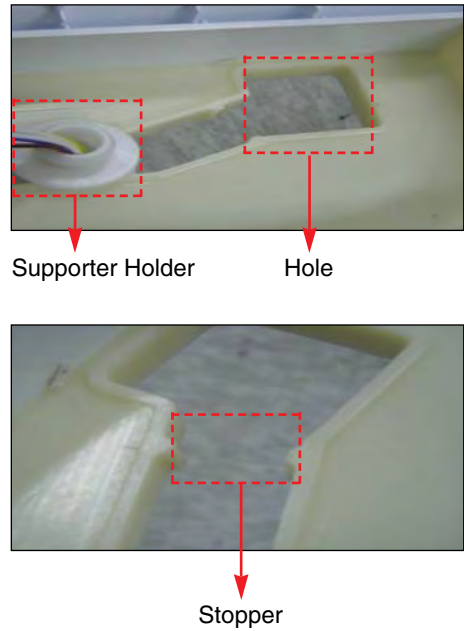

14) Pull out the auto drawer joint to the outside by using the rear hole.



15) For reassembly, perform the disassembly procedures in reverse.

3-21 HOW TO REPLACE THE AUTO DRAWER MOTOR

1) Open the door of F room.



2) Remove the Drawer.



3) Remove screws of Guide rail.(Each one in the both side)

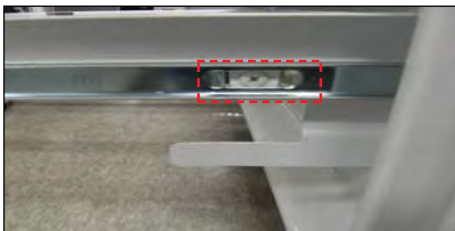

4) Lift the door to disassemble.



5) Remove the motor cover.



6) Remove the Auto Drawer Joint Housing, then separate holder lever.

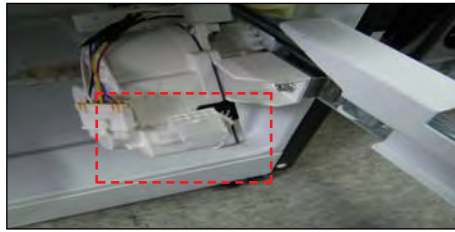

7) Using any sharp things such as drill, take out the gear in pressing the right rail clip.

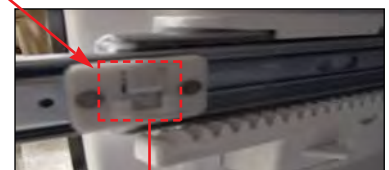
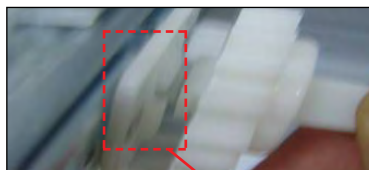

Clip

8) Take out the gear in the bar, and then bar in the motor.

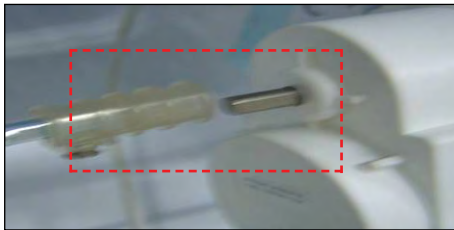
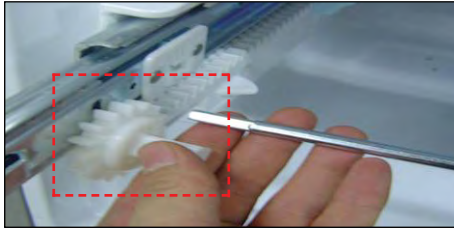

9) Remove the Auto Drawer Motor screws (2 pcs).

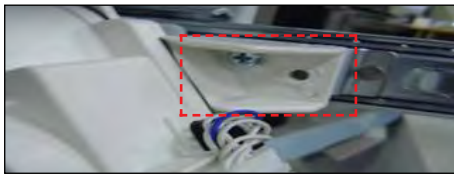

10) For reassembly, perform the disassembly procedures in reverse.

3-22 HOW TO REPLACE THE AUTO DRAWER JOINT

- 1) Remove the Converta drawer(See p.)
- 2) Remove the center plate and barrier.(See p.)
- 3) Open the F door.



4) Remove the drawer.



5) Remove screws of guide rail. (each one in the both side)

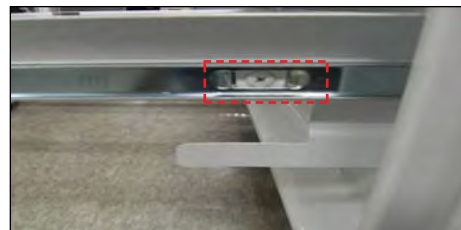

6) Lift the door to disassemble.



7) Remove the motor cover.



8) Remove the auto drawer joint housing, then separate holder lever.

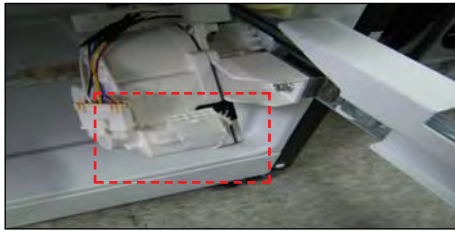

9) Using any sharp things such as drill, take out the gear in pressing the right rail clip.



Clip

10) Pull out rail to disassemble in pressing the rail stopper.

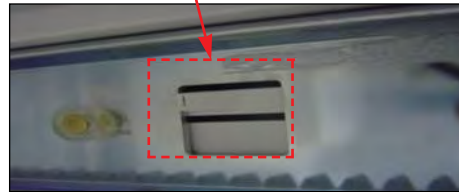

11) Remove the guide rail screws (each guide rail has 5 screws.)



12) Remove the harness.

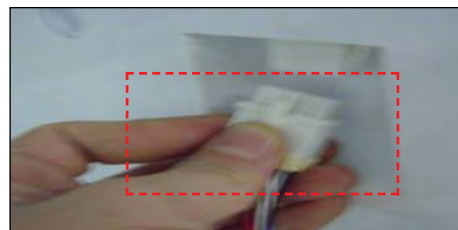
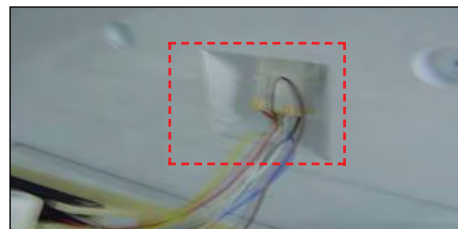

13) Pull out the Holder rail inner link by hands.

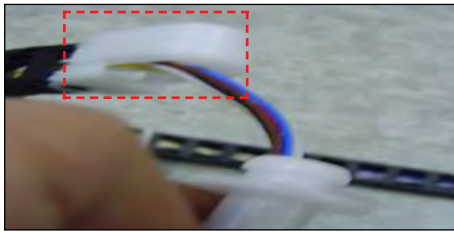

14) Take off the Holder rail fix connector.

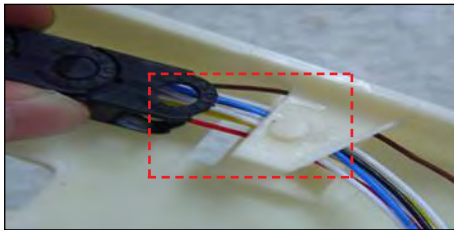
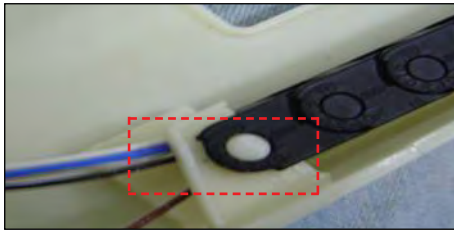

15) Pull out the support holder to the rear hole.
- Pull out the stopper part strongly.

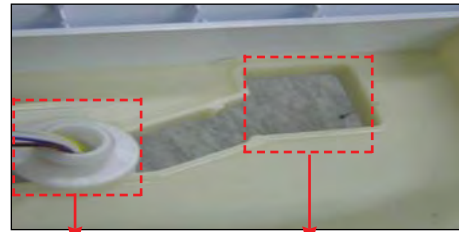

Supporter Holder

Hole

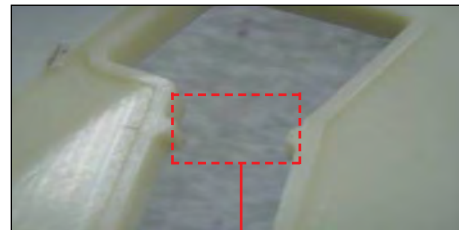

Stopper

16) Pull out the auto drawer joint to the outside by using the rear hole.



17) For reassembly, perform the disassembly procedures in reverse.

3-23 WATER VALVE DISASSEMBLY METHOD

- 1) Turn off the water to unit. Remove the waterline from the valve.

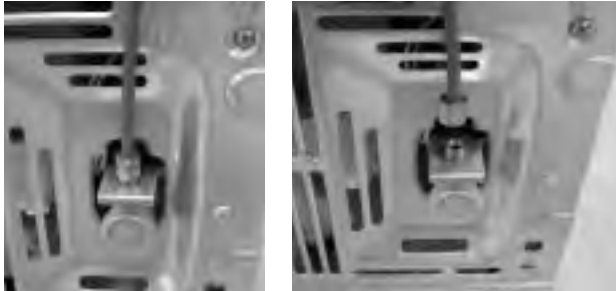

Figure 59

- 2) Remove cover and 1 screw from the valve.

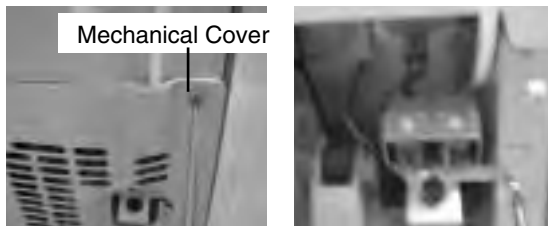

Figure 60

- 3) Separate the housing and remove the valve.



Figure 61

- 4) Remove the clip, and press the collet to separate the tube from the connector. Note: there maybe some water in the line.

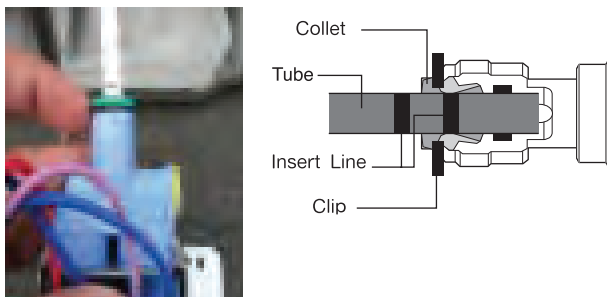

Figure 62

3-24 FAN AND FAN MOTOR DISASSEMBLY METHOD

- 1) Remove screws for the Drain Pipe Assembly and the 1 connected to the Motor Cover.

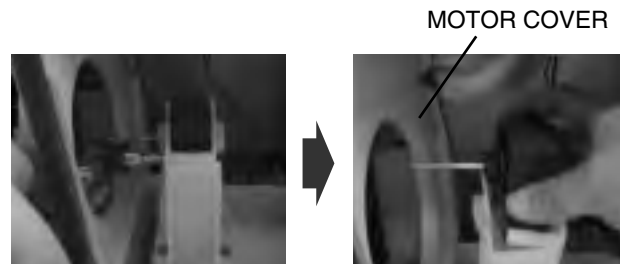

Figure 63

- 2) Separate the Fan Assembly and Motor, turn counter clockwise to remove from the motor shaft.



Figure 64

Assemble in reverse order. Taking care to avoid.

1. Do not to bend the tube during assembly.
2. Press the Water Dispenser button letting water pour out, this checks for any leaks in the tube connection, this may vary depending on the water pressure (about 2 minutes.).

3-25 TOP DRAWER

To remove the Converta drawer, pull the drawer open to full extension. Remove the drawer and Ice Bin lifting the basket from the rail system.

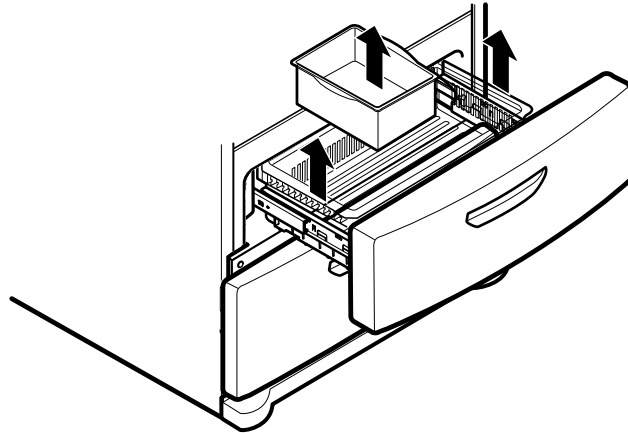

3-26 BOTTOM DRAWER

To remove the freezer drawer, pull the drawer open to full extension. Remove the lower DuraBase® basket by lifting the basket from the rail system.

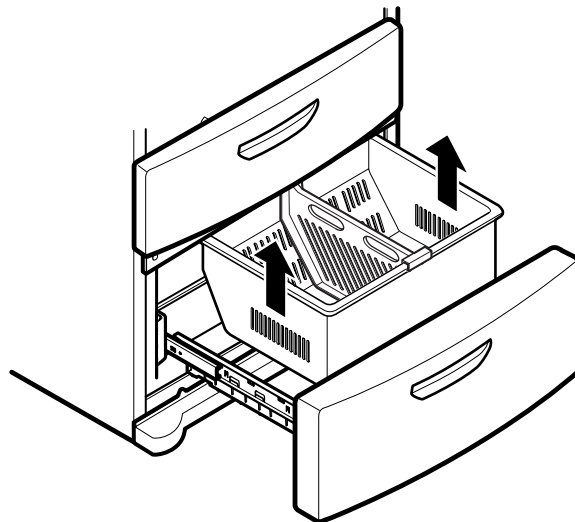

4. ADJUSTMENT

4-1 COMPRESSOR

4-1-1 Role

The compressor intakes low temperature and low pressure gas from the evaporator of the refrigerator and compresses this gas to high-temperature and high-pressure gas. It then delivers the gas to the condenser.

4-1-2 Note for Usage

- (1) Be careful not to allow over-voltage and over-current.
- (2) Do not drop or handle carelessly.
- (3) Keep away from any liquid.
If liquid such as oil or water enters the Cover PTC Compressor may fail due to breakdown of their insulating capabilities.
- (4) Always use the Parts designed for the compressor and make sure it is properly attached to the compressor. Parts may appear physically identical but could have different electrical ratings. Replace parts by part number and model number. Use only approved substitute parts.

4-1-3 Remove the cover PTC



(1) Remove the Cover Back M/C



(2) Loosen two screws on comp base



- (3) Use a L-shaped flap tool to pry off the cover
- (4) Assembly in reverse order of disassembly

4-2-3 Compressor protection logic

- Since linear Comp conducts linear reciprocating motion, we have protection logic for compressor, motor and PCB as the below.

- Stroke Trip
During the operation, if stroke is above the target value, decrease the target volt by 3V.
- Current Trip
Current trip is set in order to protect compressor mechanical part and drive from the overcurrent that might arise during the operation.
Check the current for every 416.7us and if the Trip exceeds 1.86Arms more than three times at Comp ON, forcibly stop and restart six minutes later.
- Lock Piston Trip
If stroke is under 5mm even if the current is more than 14Arms, Take it as 'piston lock' and restart after 2'30" of Comp OFF. Check the current and stroke for every 416.7us and if the condition fits more than three times at Comp ON, the Trip occurs.
- IPM fault Trip
It occurs if FO signal received from IPM is LOW. For every 416.7us, check whether FO signal is LOW. The trip occurs if it is found three times during the five periods(83ms).

5. CIRCUIT DIAGRAM



CIRCUIT DIAGRAM

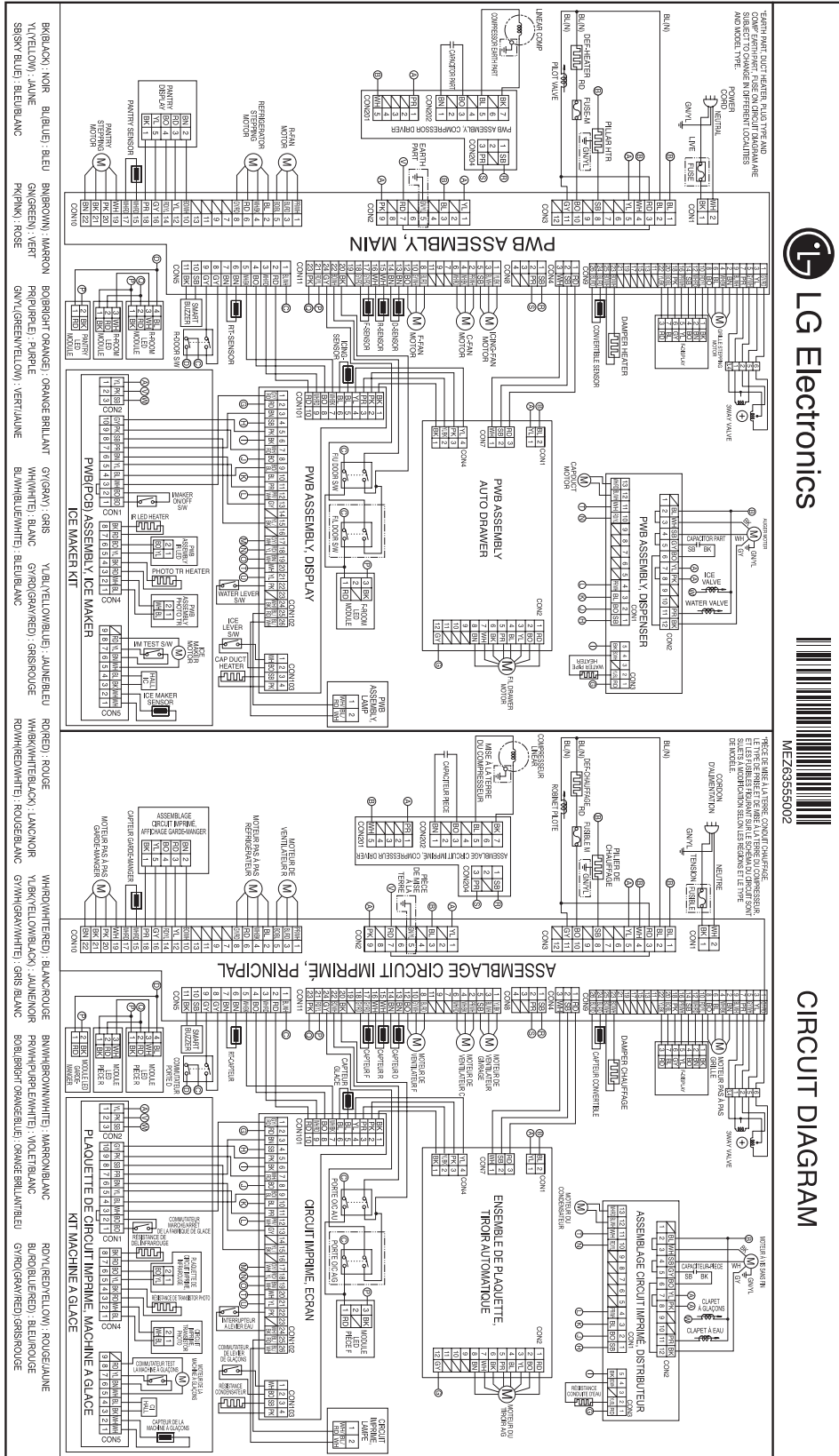

6. TROUBLESHOOTING

6-1 Error Code Summary

▲ WARNING: When checking Resistance values, make sure to turn off the power, and wait for the voltage to discharge.

NOTE) Within 3 hours after the error : Press the Ice Plus button and Freezer button simultaneously
 3 hours after the error : All errors, except for "Er rt", "Er SS", "Er IS(except for Icing sensor)", "Er gF", "Er It" error, are displayed.
 "Er IS" which is displayed without input of user is the error of Icing Sensor.

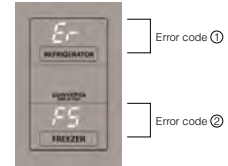

NO	Error Detection Category	Error Display		Error Generation Factors	Remark
		Freezer Temperature (Error code ①)	Refrigerator Temperature (Error code ②)		
1	Normal			None	Normal operation of Display
2	Freezer Sensor Error	Er	FS	Short or Disconnection of Freezer Sensor	Check each sensor at it's connector.
3	Refrigerator Sensor Error	Er	rS	Short or Disconnection of Refrigerator Sensor	
4	Defrosting Sensor Error	Er	dS	Short or Disconnection of Defrosting Sensor	
5	Icing Sensor Error	Er	IS	Short or disconnection of the sensor about Ice maker (Icing sensor, Ice maker sensor)	
6	Convertible Room Sensor Error	Er	CS	Short or Disconnection of Convertible Room Sensor	
7	Pantry sensor error	Er	SS	Short or Disconnection of Pantry Sensor	
8	Room Temp Sensor Error	Er	rt	Short or Disconnectoin of Room temp.sensor	
9	Ice maker kit defect	Er	It	Other Electric system error such as moter, gear, Hall IC, operation circuit within I/M kit	
10	Flow Meter(Sensor) Defect	Er	gF	Error of flow meter or water input or low water pressure	Error of flow meter or water input or low water pressure or flow meter connection
11	Poor Defrosting	Er	dH	Even though it is passed 1 hour since then Defrosting, if Defrosting sensor is not over 46°F(8°C), it is caused	Temperature Fuse Disconnection, Heater disconnection, DRAIN Jam, Poor Relay for Heater
12	Abnormality of BLDC FAN Motor for Ice Making	Er	IF	It is caused when feedback signal isn't over 65 seconds during BLDC FAN motor operating	Poor BLDC Motor connection, DRIVE IC, and TR
13	Abnormality of BLDC FAN Motor for Freezer	Er	FF	It is caused when feedback signal isn't over 65 seconds during BLDC FAN motor operating	Poor BLDC Motor connection, DRIVE IC, and TR
14	Abnormality of BLDC FAN MOTOR For Refrigerator	Er	rF	It is caused when feedback signal isn't over 65 seconds during BLDC FAN motor operating	Poor BLDC Motor connection, DRIVE IC, and TR
15	Abnormality of BLDC FAN Motor for Mechanic Room	Er	CF	It is caused when feedback signal isn't over 65 seconds during BLDC FAN motor operating	Poor BLDC Motor connection, DRIVE IC, and TR
16	Communication Error	Er	CO	Communication Error between Micom of Main PCB and Display Micom	Poor Communication connection,Poor TR of Transmitter and Receiver Tx/Rx between display and main board.

Contents

1. PCB Picture.

- . Main PCB
- . Display PCB

2. Troubleshooting with Error display.

- 1) Er FS
- 2) Er rS
- 3) Er dS
- 4) Er IS
- 5) Er CS
- 6) Er dH
- 7) Er rF
- 8) Er FF
- 9) Er IF
- 10) Er CF
- 11) Communication error

3. Troubleshooting without Error display.

- 11) Cube mode not working.
- 12) Crush mode not working.
- 13) Water mode not working.
- 14) Freezer room Lamp not working.
- 15) Refrigerator room Lamp not working.
- 16) Poor cooling.
- 17) Poor cooling.
- 18) Over cooling.
- 19) Over cooling.
- 20) Lower auto drawer doesn't work

4. Reference

- 21) TEST MODE and Removing TPA.
- 22) Temperature chart

1. PCB Picture - Main PCB

P/No & MFG	Picture
<p>EBR63597802 (2011.01~)</p>	<p>CON1</p> <p>CON2</p> <p>CON3</p> <p>CON4</p> <p>CON5</p> <p>CON8</p> <p>CON9</p> <p>CON10</p> <p>CON11</p>

1. PCB Picture - Display PCB & Sub PCB

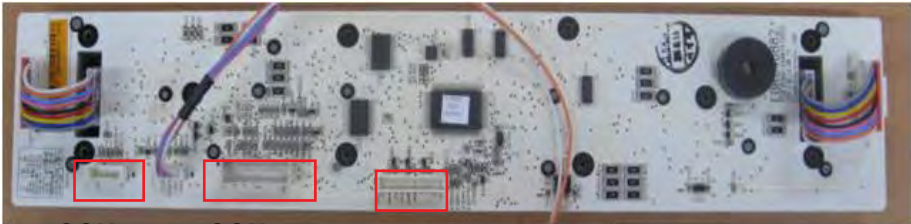
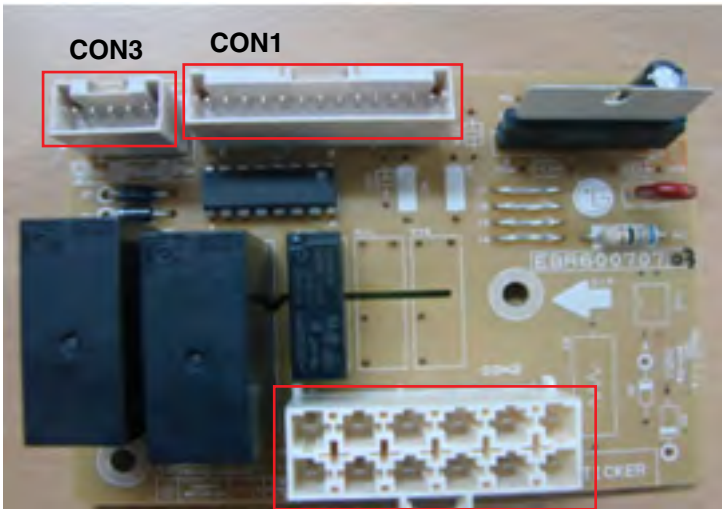
P/No	Picture
<p>Display PCB EBR64088201 (2010.09~)</p>	
	 <p>CON102 CON103 CON101</p>
<p>Sub PCB EBR60070707 (2010.02~)</p>	 <p>CON3 CON1</p> <p>CON2</p>

2. Troubleshooting With Error Display

1) Freezer Sensor Error (Er FS)



No	Checking flow	Result & SVC Action																												
1	Check for a loose connection.																													
2	<p>Check the <u>Gray/Red to Gray/Red.</u></p>  <p style="text-align: center;"><CON11></p>	<table border="1" data-bbox="889 591 1448 804"> <thead> <tr> <th colspan="2">Result</th> <th>SVC Action</th> </tr> </thead> <tbody> <tr> <td>0 Ω</td> <td>Short</td> <td>Change the sensor</td> </tr> <tr> <td>OFF</td> <td>Open</td> <td>Replace the refrigerator</td> </tr> <tr> <td>Other</td> <td>Normal</td> <td>Check the Temp and resistance (Table-1)</td> </tr> </tbody> </table> <p style="text-align: center;"><Temperature table-1></p> <table border="1" data-bbox="945 876 1377 1264"> <thead> <tr> <th>(1) To (2)</th> <th>Result</th> </tr> </thead> <tbody> <tr> <td>-22°F / -30°C</td> <td>40 kΩ</td> </tr> <tr> <td>-13°F / -25°C</td> <td>30 kΩ</td> </tr> <tr> <td>-4°F / -20°C</td> <td>23 kΩ</td> </tr> <tr> <td>5°F / -15°C</td> <td>17 kΩ</td> </tr> <tr> <td>14°F / -10°C</td> <td>13 kΩ</td> </tr> <tr> <td>23°F / -5°C</td> <td>10 kΩ</td> </tr> <tr> <td>32°F / 0°C</td> <td>8 kΩ</td> </tr> </tbody> </table> <p>※ The sensor is determined by the temperature. For example, 23kΩ indicates -4°F.</p>	Result		SVC Action	0 Ω	Short	Change the sensor	OFF	Open	Replace the refrigerator	Other	Normal	Check the Temp and resistance (Table-1)	(1) To (2)	Result	-22°F / -30°C	40 kΩ	-13°F / -25°C	30 kΩ	-4°F / -20°C	23 kΩ	5°F / -15°C	17 kΩ	14°F / -10°C	13 kΩ	23°F / -5°C	10 kΩ	32°F / 0°C	8 kΩ
Result		SVC Action																												
0 Ω	Short	Change the sensor																												
OFF	Open	Replace the refrigerator																												
Other	Normal	Check the Temp and resistance (Table-1)																												
(1) To (2)	Result																													
-22°F / -30°C	40 kΩ																													
-13°F / -25°C	30 kΩ																													
-4°F / -20°C	23 kΩ																													
5°F / -15°C	17 kΩ																													
14°F / -10°C	13 kΩ																													
23°F / -5°C	10 kΩ																													
32°F / 0°C	8 kΩ																													





2) Refrigerator Sensor Error (Er r5)

No	Checking flow	Result & SVC Action																								
1	Check for a loose connection.																									
2	<p>Check the <u>White to White</u>.</p>  <p><CON11></p>	<table border="1" data-bbox="885 591 1446 802"> <thead> <tr> <th colspan="2">Result</th> <th>SVC Action</th> </tr> </thead> <tbody> <tr> <td>0 Ω</td> <td>Short</td> <td>Change the sensor</td> </tr> <tr> <td>OFF</td> <td>Open</td> <td>Replace the refrigerator</td> </tr> <tr> <td>Other</td> <td>Normal</td> <td>Check the Temp and resistance (Table-2)</td> </tr> </tbody> </table> <p style="text-align: center;"><Temperature table-2></p> <table border="1" data-bbox="943 876 1373 1168"> <thead> <tr> <th>(1) To (2)</th> <th>Result</th> </tr> </thead> <tbody> <tr> <td>23°F / -5°C</td> <td>38 kΩ</td> </tr> <tr> <td>32°F / 0°C</td> <td>30 kΩ</td> </tr> <tr> <td>41°F / 5°C</td> <td>24 kΩ</td> </tr> <tr> <td>50°F / 10°C</td> <td>19.5 kΩ</td> </tr> <tr> <td>59°F / 15°C</td> <td>16 kΩ</td> </tr> </tbody> </table> <p>※ The sensor is determined by the temperature. For example, 30kΩ indicates 32°F.</p>	Result		SVC Action	0 Ω	Short	Change the sensor	OFF	Open	Replace the refrigerator	Other	Normal	Check the Temp and resistance (Table-2)	(1) To (2)	Result	23°F / -5°C	38 kΩ	32°F / 0°C	30 kΩ	41°F / 5°C	24 kΩ	50°F / 10°C	19.5 kΩ	59°F / 15°C	16 kΩ
Result		SVC Action																								
0 Ω	Short	Change the sensor																								
OFF	Open	Replace the refrigerator																								
Other	Normal	Check the Temp and resistance (Table-2)																								
(1) To (2)	Result																									
23°F / -5°C	38 kΩ																									
32°F / 0°C	30 kΩ																									
41°F / 5°C	24 kΩ																									
50°F / 10°C	19.5 kΩ																									
59°F / 15°C	16 kΩ																									



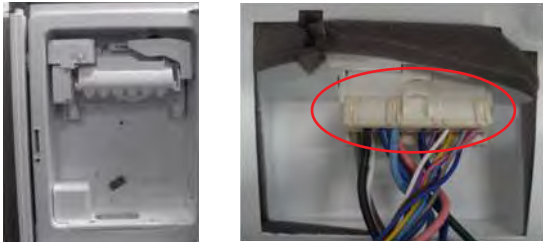

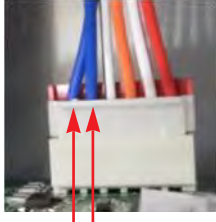
3) Icing Sensor Error (Er IS)

No	Checking flow	Result & SVC Action																												
1	Check for a loose connection.																													
2	<p>Check the Blue to Blue.</p>     <p>CON101</p> <p><Display> <CON101></p>	<table border="1" data-bbox="889 597 1448 806"> <thead> <tr> <th colspan="2">Result</th> <th>SVC Action</th> </tr> </thead> <tbody> <tr> <td>0 Ω</td> <td>Short</td> <td>Change the sensor</td> </tr> <tr> <td>OFF</td> <td>Open</td> <td>Replace the refrigerator</td> </tr> <tr> <td>Other</td> <td>Normal</td> <td>Check the Temp and resistance (Table-1)</td> </tr> </tbody> </table> <p data-bbox="1016 846 1305 876"><Temperature table-1></p> <table border="1" data-bbox="945 880 1377 1272"> <thead> <tr> <th>(1) To (2)</th> <th>Result</th> </tr> </thead> <tbody> <tr> <td>-22°F / -30°C</td> <td>40 kΩ</td> </tr> <tr> <td>-13°F / -25°C</td> <td>30 kΩ</td> </tr> <tr> <td>-4°F / -20°C</td> <td>23 kΩ</td> </tr> <tr> <td>5°F / -15°C</td> <td>17 kΩ</td> </tr> <tr> <td>14°F / -10°C</td> <td>13 kΩ</td> </tr> <tr> <td>23°F / -5°C</td> <td>10 kΩ</td> </tr> <tr> <td>32°F / 0°C</td> <td>8 kΩ</td> </tr> </tbody> </table> <p data-bbox="889 1289 1341 1383">* The sensor is determined by the temperature. For example, 23kΩ indicates -4°F.</p>	Result		SVC Action	0 Ω	Short	Change the sensor	OFF	Open	Replace the refrigerator	Other	Normal	Check the Temp and resistance (Table-1)	(1) To (2)	Result	-22°F / -30°C	40 kΩ	-13°F / -25°C	30 kΩ	-4°F / -20°C	23 kΩ	5°F / -15°C	17 kΩ	14°F / -10°C	13 kΩ	23°F / -5°C	10 kΩ	32°F / 0°C	8 kΩ
Result		SVC Action																												
0 Ω	Short	Change the sensor																												
OFF	Open	Replace the refrigerator																												
Other	Normal	Check the Temp and resistance (Table-1)																												
(1) To (2)	Result																													
-22°F / -30°C	40 kΩ																													
-13°F / -25°C	30 kΩ																													
-4°F / -20°C	23 kΩ																													
5°F / -15°C	17 kΩ																													
14°F / -10°C	13 kΩ																													
23°F / -5°C	10 kΩ																													
32°F / 0°C	8 kΩ																													





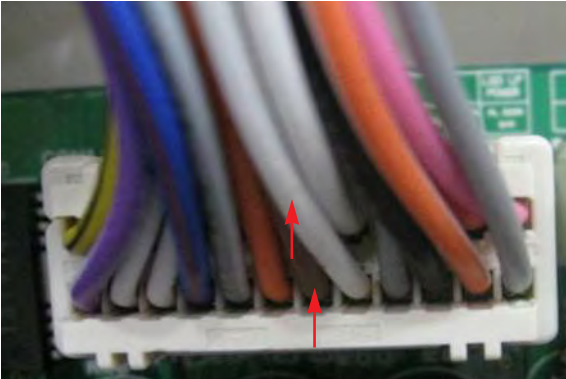

4) Defrost Sensor Error (Er dS)

No	Checking flow	Result & SVC Action																								
1	<p>Check for a loose connection.</p> 																									
2	<p>Check the <u>Orange to Orange.</u></p>  <p>Check the <u>Brown to Brown.</u></p>  <p><CON11></p>	<table border="1" data-bbox="885 793 1446 1002"> <thead> <tr> <th colspan="2">Result</th> <th>SVC Action</th> </tr> </thead> <tbody> <tr> <td>0 Ω</td> <td>Short</td> <td>Change the sensor</td> </tr> <tr> <td>OFF</td> <td>Open</td> <td>Replace the refrigerator</td> </tr> <tr> <td>Other</td> <td>Normal</td> <td>Check the Temp and resistance (Table-3)</td> </tr> </tbody> </table> <p data-bbox="1013 1044 1300 1072"><Temperature table-3></p> <table border="1" data-bbox="943 1078 1373 1370"> <thead> <tr> <th>(1) To (2)</th> <th>Result</th> </tr> </thead> <tbody> <tr> <td>23°F / -5°C</td> <td>38 kΩ</td> </tr> <tr> <td>32°F / 0°C</td> <td>30 kΩ</td> </tr> <tr> <td>41°F / 5°C</td> <td>24 kΩ</td> </tr> <tr> <td>50°F / 10°C</td> <td>19.5 kΩ</td> </tr> <tr> <td>59°F / -15°C</td> <td>16 kΩ</td> </tr> </tbody> </table> <p data-bbox="888 1395 1338 1491">* The sensor is determined by the temperature. For example, 23kΩ indicates -4°F.</p>	Result		SVC Action	0 Ω	Short	Change the sensor	OFF	Open	Replace the refrigerator	Other	Normal	Check the Temp and resistance (Table-3)	(1) To (2)	Result	23°F / -5°C	38 kΩ	32°F / 0°C	30 kΩ	41°F / 5°C	24 kΩ	50°F / 10°C	19.5 kΩ	59°F / -15°C	16 kΩ
Result		SVC Action																								
0 Ω	Short	Change the sensor																								
OFF	Open	Replace the refrigerator																								
Other	Normal	Check the Temp and resistance (Table-3)																								
(1) To (2)	Result																									
23°F / -5°C	38 kΩ																									
32°F / 0°C	30 kΩ																									
41°F / 5°C	24 kΩ																									
50°F / 10°C	19.5 kΩ																									
59°F / -15°C	16 kΩ																									

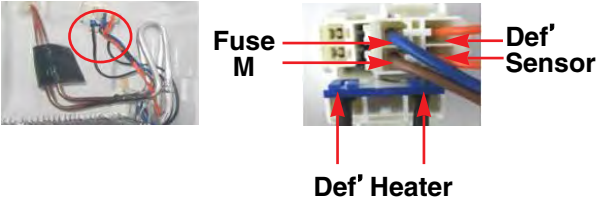

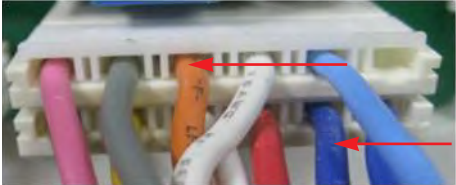
5) Defrost Heater Error (Er dH)

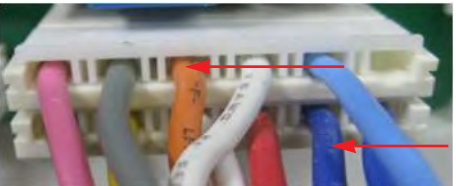
No	Checking flow	Result & SVC Action																		
1	Check the <u>Door gasket</u> .																			
2	Check the <u>Defrost control part</u> . 	<table border="1"> <thead> <tr> <th>Part</th> <th>Result</th> <th>SVC Action</th> </tr> </thead> <tbody> <tr> <td rowspan="2">Fuse-M</td> <td>0 Ω</td> <td>Go to the 3</td> </tr> <tr> <td>Other</td> <td>Change Fuse-M</td> </tr> <tr> <td rowspan="2">Def' Heater</td> <td>34~42 Ω</td> <td>Go to the 3</td> </tr> <tr> <td>Other</td> <td>Change Fuse-M</td> </tr> <tr> <td rowspan="2">Def' Sensor</td> <td>22 kΩ ↑</td> <td>Go to the 3</td> </tr> <tr> <td>OFF</td> <td>Replace product</td> </tr> </tbody> </table>	Part	Result	SVC Action	Fuse-M	0 Ω	Go to the 3	Other	Change Fuse-M	Def' Heater	34~42 Ω	Go to the 3	Other	Change Fuse-M	Def' Sensor	22 kΩ ↑	Go to the 3	OFF	Replace product
Part	Result	SVC Action																		
Fuse-M	0 Ω	Go to the 3																		
	Other	Change Fuse-M																		
Def' Heater	34~42 Ω	Go to the 3																		
	Other	Change Fuse-M																		
Def' Sensor	22 kΩ ↑	Go to the 3																		
	OFF	Replace product																		
3	Input Test 3 Mode. (push the button 3 times)																			
4	Check the <u>Blue to Orange</u> .  <CON3>	<table border="1"> <thead> <tr> <th>Result</th> <th>SVC Action</th> </tr> </thead> <tbody> <tr> <td>112 ~ 116V</td> <td>Go to the 5</td> </tr> <tr> <td>0 V</td> <td>Replace Main PCB</td> </tr> </tbody> </table>	Result	SVC Action	112 ~ 116V	Go to the 5	0 V	Replace Main PCB												
Result	SVC Action																			
112 ~ 116V	Go to the 5																			
0 V	Replace Main PCB																			
5	Release the test mode. push the button 1 times. (normal)																			
6	Check the <u>Blue to Orange</u> .  <CON3>	<table border="1"> <thead> <tr> <th>Result</th> <th>SVC Action</th> </tr> </thead> <tbody> <tr> <td>0 V</td> <td>Explain to customer</td> </tr> <tr> <td>112 ~ 116V</td> <td>Replace Main PCB</td> </tr> </tbody> </table>	Result	SVC Action	0 V	Explain to customer	112 ~ 116V	Replace Main PCB												
Result	SVC Action																			
0 V	Explain to customer																			
112 ~ 116V	Replace Main PCB																			





6) Convertible Sensor Error (Er CS)

No	Checking flow	Result & SVC Action																								
1	Check for a loose connection.																									
2	<p>Check the <u>Blue/Red to Blue/Red.</u></p>  <p><CON9></p>	<table border="1" data-bbox="886 512 1446 732"> <thead> <tr> <th colspan="2">Result</th> <th>SVC Action</th> </tr> </thead> <tbody> <tr> <td>0Ω</td> <td>Short</td> <td>Replace the refrigerator</td> </tr> <tr> <td>OFF</td> <td>Open</td> <td>Change the sensor</td> </tr> <tr> <td>Other</td> <td>Normal</td> <td>Check the Temp and resistance (Table-2)</td> </tr> </tbody> </table> <p style="text-align: center;"><Temperature table-1></p> <table border="1" data-bbox="954 821 1385 1112"> <thead> <tr> <th>(1) To (2)</th> <th>Result</th> </tr> </thead> <tbody> <tr> <td>50°F / 10°C</td> <td>19.5 kΩ</td> </tr> <tr> <td>41°F / 5°C</td> <td>24 kΩ</td> </tr> <tr> <td>32°F / 0°C</td> <td>30 kΩ</td> </tr> <tr> <td>23°F / -5°C</td> <td>38 kΩ</td> </tr> <tr> <td>59°F / 15°C</td> <td>16 kΩ</td> </tr> </tbody> </table> <p>※ The sensor is determined by the temperature. For example, 30kΩ indicates 32°F</p>	Result		SVC Action	0Ω	Short	Replace the refrigerator	OFF	Open	Change the sensor	Other	Normal	Check the Temp and resistance (Table-2)	(1) To (2)	Result	50°F / 10°C	19.5 kΩ	41°F / 5°C	24 kΩ	32°F / 0°C	30 kΩ	23°F / -5°C	38 kΩ	59°F / 15°C	16 kΩ
Result		SVC Action																								
0Ω	Short	Replace the refrigerator																								
OFF	Open	Change the sensor																								
Other	Normal	Check the Temp and resistance (Table-2)																								
(1) To (2)	Result																									
50°F / 10°C	19.5 kΩ																									
41°F / 5°C	24 kΩ																									
32°F / 0°C	30 kΩ																									
23°F / -5°C	38 kΩ																									
59°F / 15°C	16 kΩ																									





7) Refrigerator Fan Error (Er rF)

No	Checking flow	Result & SVC Action									
1	<p>Reset the unit and Input Test 1 Mode. (push the button 1 time)</p>										
2	<p>Open the freezer door and Check the air flow. ※ While an error code is displayed, the fan is not working.</p>	 <table border="1" data-bbox="1128 1059 1453 1206"> <thead> <tr> <th>Status</th> <th>SVC Action</th> </tr> </thead> <tbody> <tr> <td>No windy</td> <td>Go to 3</td> </tr> <tr> <td>Windy</td> <td>Go to 4</td> </tr> </tbody> </table>	Status	SVC Action	No windy	Go to 3	Windy	Go to 4			
Status	SVC Action										
No windy	Go to 3										
Windy	Go to 4										
4	<p>Check the <u>Fan motor voltage.</u></p>  <p>(3)(2)(1) <CON10></p>	<table border="1" data-bbox="888 1351 1450 1495"> <thead> <tr> <th>Point</th> <th>Result</th> <th>SVC Action</th> </tr> </thead> <tbody> <tr> <td>(1)~(2)</td> <td>Below 12V</td> <td>Change the PCB</td> </tr> <tr> <td>(1)~(3)</td> <td>0 or 5 V</td> <td>Change the motor</td> </tr> </tbody> </table>	Point	Result	SVC Action	(1)~(2)	Below 12V	Change the PCB	(1)~(3)	0 or 5 V	Change the motor
Point	Result	SVC Action									
(1)~(2)	Below 12V	Change the PCB									
(1)~(3)	0 or 5 V	Change the motor									

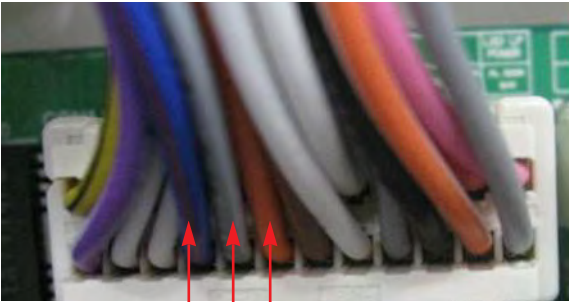

8) Freezer Fan Error (Er FF)

No	Checking flow	Result & SVC Action									
1	<p>Reset the unit and Input Test 1 Mode. (push the button 1 time)</p>										
2	<p>Open the freezer door and Check the air flow. ※ While an error code is displayed, the fan is not working.</p>	 <table border="1" data-bbox="1127 885 1451 1032"> <thead> <tr> <th>Status</th> <th>SVC Action</th> </tr> </thead> <tbody> <tr> <td>No windy</td> <td>Go to 3</td> </tr> <tr> <td>Windy</td> <td>Go to 4</td> </tr> </tbody> </table>	Status	SVC Action	No windy	Go to 3	Windy	Go to 4			
Status	SVC Action										
No windy	Go to 3										
Windy	Go to 4										
3	<p>Check the <u>Fan motor</u>.</p> 	<p>Rotate fan using your hand. It feel sticky, change the motor. (cause of ice or rust inside of motor)</p>									
4	<p>Check the <u>Fan motor voltage</u>.</p>  <p>(3) (2) (1) <CON11></p>	<table border="1" data-bbox="886 1434 1446 1576"> <thead> <tr> <th>Point</th> <th>Result</th> <th>SVC Action</th> </tr> </thead> <tbody> <tr> <td>(1)~(2)</td> <td>Below 12V</td> <td>Change the PCB</td> </tr> <tr> <td>(1)~(3)</td> <td>0 or 5 V</td> <td>Change the motor</td> </tr> </tbody> </table>	Point	Result	SVC Action	(1)~(2)	Below 12V	Change the PCB	(1)~(3)	0 or 5 V	Change the motor
Point	Result	SVC Action									
(1)~(2)	Below 12V	Change the PCB									
(1)~(3)	0 or 5 V	Change the motor									





9) Icing Fan Error (Er IF)

No	Checking flow	Result & SVC Action									
1	<p>Reset the unit and Input Test 1 Mode. (push the button 1 time)</p>										
2	<p>Open the refrigerator door and Check the air flow. ※ While an error code is displayed, the fan is not working.</p>	<table border="1"> <thead> <tr> <th>Status</th> <th>SVC Action</th> </tr> </thead> <tbody> <tr> <td>No windy</td> <td>Go to the 3, 4</td> </tr> <tr> <td>windy</td> <td>Go to the 5</td> </tr> </tbody> </table>	Status	SVC Action	No windy	Go to the 3, 4	windy	Go to the 5			
Status	SVC Action										
No windy	Go to the 3, 4										
windy	Go to the 5										
3	<p>Check the <u>Connector</u>. (Frozen caused the PCB short)</p>	<p>※ Tip To protect ice short, add wire seal in connector. We developed new type connector, so order the new type.</p> <p>Wire seal (Silicon)</p> <table border="1"> <thead> <tr> <th>No</th> <th>Part Name</th> <th>Old P/No</th> <th>New P/No</th> </tr> </thead> <tbody> <tr> <td>407A</td> <td>Duct Asm, Connector</td> <td>5209JA 1044A</td> <td>5209JA 1044A</td> </tr> </tbody> </table>	No	Part Name	Old P/No	New P/No	407A	Duct Asm, Connector	5209JA 1044A	5209JA 1044A	
No	Part Name	Old P/No	New P/No								
407A	Duct Asm, Connector	5209JA 1044A	5209JA 1044A								
4	<p>Check the <u>Fan motor</u>. (Frozen, Lock, ect.)</p>	<p>(3) (2) (1)</p> <p><CON11></p> <table border="1"> <thead> <tr> <th></th> <th>Result</th> <th>SVC Action</th> </tr> </thead> <tbody> <tr> <td>(1)~(2)</td> <td>Below 9V</td> <td>Change the PCB</td> </tr> <tr> <td>(1)~(3)</td> <td>0 or 5 V</td> <td>Change the motor</td> </tr> </tbody> </table>		Result	SVC Action	(1)~(2)	Below 9V	Change the PCB	(1)~(3)	0 or 5 V	Change the motor
	Result	SVC Action									
(1)~(2)	Below 9V	Change the PCB									
(1)~(3)	0 or 5 V	Change the motor									
4	<p>Check the <u>Fan motor voltage</u>.</p> <p>(3) (2) (1)</p> <p><CON11></p>	<table border="1"> <thead> <tr> <th></th> <th>Result</th> <th>SVC Action</th> </tr> </thead> <tbody> <tr> <td>(1)~(2)</td> <td>Below 9V</td> <td>Change the PCB</td> </tr> <tr> <td>(1)~(3)</td> <td>0 or 5 V</td> <td>Change the motor</td> </tr> </tbody> </table>		Result	SVC Action	(1)~(2)	Below 9V	Change the PCB	(1)~(3)	0 or 5 V	Change the motor
	Result	SVC Action									
(1)~(2)	Below 9V	Change the PCB									
(1)~(3)	0 or 5 V	Change the motor									



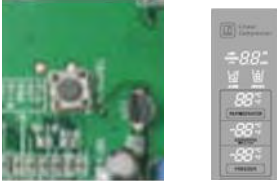

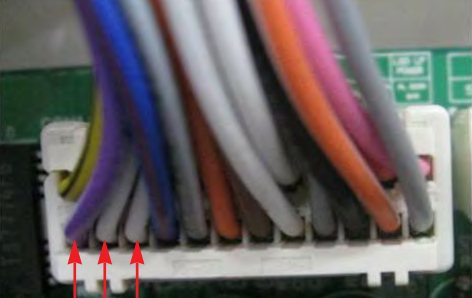

10) Condenser Fan Error (Er CF)

No	Checking flow	Result & SVC Action									
1	Reset the unit and Input Test 1 Mode. (push the button 1 time)										
2	Check the fan rotating. ※ While an error code is displayed, the fan is not working.	 <table border="1" data-bbox="1128 691 1453 840"> <thead> <tr> <th>Status</th> <th>SVC Action</th> </tr> </thead> <tbody> <tr> <td>No windy</td> <td>Check motor</td> </tr> <tr> <td>Windy</td> <td>Go to the 4</td> </tr> </tbody> </table>	Status	SVC Action	No windy	Check motor	Windy	Go to the 4			
Status	SVC Action										
No windy	Check motor										
Windy	Go to the 4										
3	Check the <u>Fan motor</u> and <u>surrounding</u>. 	Rotate fan using your hand. It feel sticky, change the motor.									
4	Check the <u>Fan motor voltage</u>.  (3)(2)(1) <CON11>	<table border="1" data-bbox="889 1240 1450 1389"> <thead> <tr> <th></th> <th>Result</th> <th>SVC Action</th> </tr> </thead> <tbody> <tr> <td>(1)~(2)</td> <td>Blew 10V</td> <td>Change the PCB</td> </tr> <tr> <td>(1)~(3)</td> <td>0 or 5 V</td> <td>Change the motor</td> </tr> </tbody> </table>		Result	SVC Action	(1)~(2)	Blew 10V	Change the PCB	(1)~(3)	0 or 5 V	Change the motor
	Result	SVC Action									
(1)~(2)	Blew 10V	Change the PCB									
(1)~(3)	0 or 5 V	Change the motor									





11) Communication Error (Er CO)

No	Checking flow	Result & SVC Action						
1	Check the loose connection.							
2	<p>Check the <u>Red to White/Red.</u></p>  <p>CON101 <Display></p>	<table border="1"> <thead> <tr> <th>Result</th> <th>SVC Action</th> </tr> </thead> <tbody> <tr> <td>12 V</td> <td>Go to the 3</td> </tr> <tr> <td>Other</td> <td>Check the Hinge (loose connection) Change the Main PCB</td> </tr> </tbody> </table>	Result	SVC Action	12 V	Go to the 3	Other	Check the Hinge (loose connection) Change the Main PCB
Result	SVC Action							
12 V	Go to the 3							
Other	Check the Hinge (loose connection) Change the Main PCB							
3	<p>Check the <u>Orange to White/Red.</u></p>  <p>CON101 <Display></p>	<table border="1"> <thead> <tr> <th>Result</th> <th>SVC Action</th> </tr> </thead> <tbody> <tr> <td>0V or 5V</td> <td>Change the Display PCB</td> </tr> <tr> <td>Other</td> <td>Go to the 4</td> </tr> </tbody> </table>	Result	SVC Action	0V or 5V	Change the Display PCB	Other	Go to the 4
Result	SVC Action							
0V or 5V	Change the Display PCB							
Other	Go to the 4							
4	<p>Check the <u>White/Black to White/Red.</u></p>  <p>CON101 <Display></p>	<table border="1"> <thead> <tr> <th>Result</th> <th>SVC Action</th> </tr> </thead> <tbody> <tr> <td>0 V or 5 V</td> <td>Change the Main PCB</td> </tr> <tr> <td>Other</td> <td>Go to the 5</td> </tr> </tbody> </table>	Result	SVC Action	0 V or 5 V	Change the Main PCB	Other	Go to the 5
Result	SVC Action							
0 V or 5 V	Change the Main PCB							
Other	Go to the 5							
5	<p>Check the <u>White/Red to Orange.</u></p>  <p><CON5></p>	<table border="1"> <thead> <tr> <th>Result</th> <th>SVC Action</th> </tr> </thead> <tbody> <tr> <td>0 V or 5 V</td> <td>Change the Display PCB</td> </tr> <tr> <td>Other</td> <td>Go to the 6</td> </tr> </tbody> </table>	Result	SVC Action	0 V or 5 V	Change the Display PCB	Other	Go to the 6
Result	SVC Action							
0 V or 5 V	Change the Display PCB							
Other	Go to the 6							
6	<p>Check the <u>White/Red to White/Black.</u></p>  <p><CON5></p>	<table border="1"> <thead> <tr> <th>Result</th> <th>SVC Action</th> </tr> </thead> <tbody> <tr> <td>0 V or 5 V</td> <td>Change the Main PCB</td> </tr> <tr> <td>Other</td> <td>Explain to customer</td> </tr> </tbody> </table>	Result	SVC Action	0 V or 5 V	Change the Main PCB	Other	Explain to customer
Result	SVC Action							
0 V or 5 V	Change the Main PCB							
Other	Explain to customer							

3. Troubleshooting Without Error Display



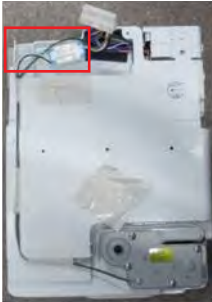
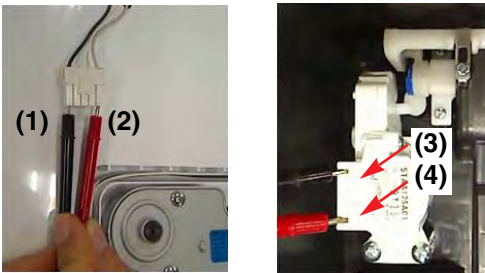

1) Cube mode doesn't work

No	Checking flow	Result & SVC Action													
1	Check the loose connection.														
2	<p>Check the Black to White. (While pushing the lever S/W)</p>  <p style="text-align: center;"><CON2></p>	<table border="1"> <thead> <tr> <th>Lever s/w</th> <th>Result</th> <th>SVC Action</th> </tr> </thead> <tbody> <tr> <td rowspan="2">Pushing</td> <td>112~115 V</td> <td>Go to the 3</td> </tr> <tr> <td>Other</td> <td>Change PCB</td> </tr> <tr> <td rowspan="2">Not pushing</td> <td>0 ~ 2 V</td> <td>Go to the 3</td> </tr> <tr> <td>Other</td> <td>Change PCB</td> </tr> </tbody> </table>	Lever s/w	Result	SVC Action	Pushing	112~115 V	Go to the 3	Other	Change PCB	Not pushing	0 ~ 2 V	Go to the 3	Other	Change PCB
Lever s/w	Result	SVC Action													
Pushing	112~115 V	Go to the 3													
	Other	Change PCB													
Not pushing	0 ~ 2 V	Go to the 3													
	Other	Change PCB													
3	<p>Check the RED to White Red. (While pushing the lever S/W)</p>  <p style="text-align: center;"><CON3> <CON1></p>	<table border="1"> <thead> <tr> <th>Lever s/w</th> <th>Result</th> <th>SVC Action</th> </tr> </thead> <tbody> <tr> <td rowspan="2">Pushing</td> <td>9~12 V</td> <td>Go to the 4</td> </tr> <tr> <td>Other</td> <td>Change PCB</td> </tr> <tr> <td rowspan="2">Not pushing</td> <td>0 ~ 2 V</td> <td>Go to the 4</td> </tr> <tr> <td>Other</td> <td>Change PCB</td> </tr> </tbody> </table>	Lever s/w	Result	SVC Action	Pushing	9~12 V	Go to the 4	Other	Change PCB	Not pushing	0 ~ 2 V	Go to the 4	Other	Change PCB
Lever s/w	Result	SVC Action													
Pushing	9~12 V	Go to the 4													
	Other	Change PCB													
Not pushing	0 ~ 2 V	Go to the 4													
	Other	Change PCB													
4	<p>Check the resistance value.</p>  <p style="text-align: center;"><Ice Maker></p>  <p style="text-align: center;"><Geared Motor> <Dispenser Motor></p>	<table border="1"> <thead> <tr> <th>Point</th> <th>Result</th> <th>SVC Action</th> </tr> </thead> <tbody> <tr> <td rowspan="2">(1) to (2)</td> <td>31.1 ~ 42.1 Ω</td> <td>Explain</td> </tr> <tr> <td>Other</td> <td>Replace Geared Motor</td> </tr> <tr> <td rowspan="2">(3) to (4)</td> <td>9.9 ~ 12.1 Ω</td> <td>Explain</td> </tr> <tr> <td>Other</td> <td>Replace Geared Motor</td> </tr> </tbody> </table>	Point	Result	SVC Action	(1) to (2)	31.1 ~ 42.1 Ω	Explain	Other	Replace Geared Motor	(3) to (4)	9.9 ~ 12.1 Ω	Explain	Other	Replace Geared Motor
Point	Result	SVC Action													
(1) to (2)	31.1 ~ 42.1 Ω	Explain													
	Other	Replace Geared Motor													
(3) to (4)	9.9 ~ 12.1 Ω	Explain													
	Other	Replace Geared Motor													



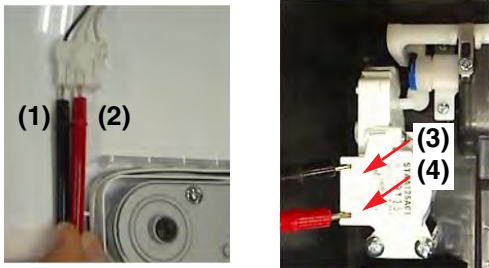

2) Crush mode doesn't work

No	Checking flow	Result & SVC Action													
1	Check the loose connection.														
2	<p>Check the <u>Sky Blue to White</u>. (While pushing the lever S/W)</p>  <p style="text-align: center;"><CON2></p>	<table border="1"> <thead> <tr> <th>Lever s/w</th> <th>Result</th> <th>SVC Action</th> </tr> </thead> <tbody> <tr> <td rowspan="2">Pushing</td> <td>112~115 V</td> <td>Go to the 3</td> </tr> <tr> <td>Other</td> <td>Change PCB</td> </tr> <tr> <td rowspan="2">Not pushing</td> <td>0 ~ 2 V</td> <td>Go to the 3</td> </tr> <tr> <td>Other</td> <td>Change PCB</td> </tr> </tbody> </table>	Lever s/w	Result	SVC Action	Pushing	112~115 V	Go to the 3	Other	Change PCB	Not pushing	0 ~ 2 V	Go to the 3	Other	Change PCB
Lever s/w	Result	SVC Action													
Pushing	112~115 V	Go to the 3													
	Other	Change PCB													
Not pushing	0 ~ 2 V	Go to the 3													
	Other	Change PCB													
3	<p>Check the <u>Red to White Red</u>. (While pushing the lever S/W)</p>  <p style="text-align: center;"><CON3> <CON1></p>	<table border="1"> <thead> <tr> <th>Lever s/w</th> <th>Result</th> <th>SVC Action</th> </tr> </thead> <tbody> <tr> <td rowspan="2">Pushing</td> <td>9~12 V</td> <td>Go to the 4</td> </tr> <tr> <td>Other</td> <td>Change PCB</td> </tr> <tr> <td rowspan="2">Not pushing</td> <td>0 ~ 2 V</td> <td>Go to the 4</td> </tr> <tr> <td>Other</td> <td>Change PCB</td> </tr> </tbody> </table>	Lever s/w	Result	SVC Action	Pushing	9~12 V	Go to the 4	Other	Change PCB	Not pushing	0 ~ 2 V	Go to the 4	Other	Change PCB
Lever s/w	Result	SVC Action													
Pushing	9~12 V	Go to the 4													
	Other	Change PCB													
Not pushing	0 ~ 2 V	Go to the 4													
	Other	Change PCB													
4	<p>Check the resistance value.</p>  <p style="text-align: center;"><Ice Maker></p>  <p style="text-align: center;"><Geared Motor> <Dispenser Motor></p>	<table border="1"> <thead> <tr> <th>Point</th> <th>Result</th> <th>SVC Action</th> </tr> </thead> <tbody> <tr> <td rowspan="2">(1) to (2)</td> <td>31.1 ~ 42.1 Ω</td> <td>Explain</td> </tr> <tr> <td>Other</td> <td>Replace Geared Motor</td> </tr> <tr> <td rowspan="2">(3) to (4)</td> <td>9.9 ~ 12.1 Ω</td> <td>Explain</td> </tr> <tr> <td>Other</td> <td>Replace Geared Motor</td> </tr> </tbody> </table>	Point	Result	SVC Action	(1) to (2)	31.1 ~ 42.1 Ω	Explain	Other	Replace Geared Motor	(3) to (4)	9.9 ~ 12.1 Ω	Explain	Other	Replace Geared Motor
Point	Result	SVC Action													
(1) to (2)	31.1 ~ 42.1 Ω	Explain													
	Other	Replace Geared Motor													
(3) to (4)	9.9 ~ 12.1 Ω	Explain													
	Other	Replace Geared Motor													

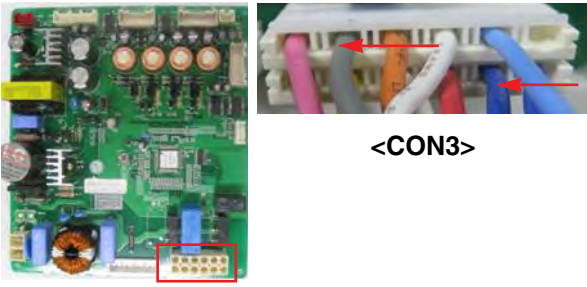
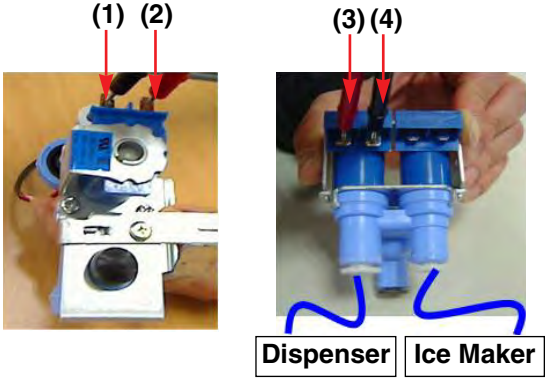

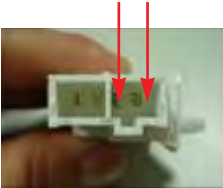

3) Water mode doesn't work

No	Checking flow	Result & SVC Action													
1	Check the loose connection.														
2	<p>Check the Purple to White. (While pushing the lever S/W)</p>  <p style="text-align: center;"><CON2></p>	<table border="1"> <thead> <tr> <th>Lever s/w</th> <th>Result</th> <th>SVC Action</th> </tr> </thead> <tbody> <tr> <td rowspan="2">Pushing</td> <td>112 ~ 115 V</td> <td>Go to the 3</td> </tr> <tr> <td>Other</td> <td>Change PCB</td> </tr> <tr> <td rowspan="2">Not pushing</td> <td>0 ~2 V</td> <td>Go to the 3</td> </tr> <tr> <td>Other</td> <td>Change PCB</td> </tr> </tbody> </table>	Lever s/w	Result	SVC Action	Pushing	112 ~ 115 V	Go to the 3	Other	Change PCB	Not pushing	0 ~2 V	Go to the 3	Other	Change PCB
Lever s/w	Result	SVC Action													
Pushing	112 ~ 115 V	Go to the 3													
	Other	Change PCB													
Not pushing	0 ~2 V	Go to the 3													
	Other	Change PCB													
3	<p>Check the Blue to Gray. (While pushing the lever S/W)</p>  <p style="text-align: center;"><CON3></p>	<table border="1"> <thead> <tr> <th>Lever s/w</th> <th>Result</th> <th>SVC Action</th> </tr> </thead> <tbody> <tr> <td rowspan="2">Pushing</td> <td>112 ~ 115 V</td> <td>Go to the 4</td> </tr> <tr> <td>Other</td> <td>Change PCB</td> </tr> <tr> <td rowspan="2">Not pushing</td> <td>0 ~2 V</td> <td>Go to the 4</td> </tr> <tr> <td>Other</td> <td>Change PCB</td> </tr> </tbody> </table>	Lever s/w	Result	SVC Action	Pushing	112 ~ 115 V	Go to the 4	Other	Change PCB	Not pushing	0 ~2 V	Go to the 4	Other	Change PCB
Lever s/w	Result	SVC Action													
Pushing	112 ~ 115 V	Go to the 4													
	Other	Change PCB													
Not pushing	0 ~2 V	Go to the 4													
	Other	Change PCB													
4	<p>Check the resistance value.</p>  <p style="text-align: center;"><Pilot Valve> Machine Room</p> <p style="text-align: center;"><Water Valve> In door</p>	<table border="1"> <thead> <tr> <th>Point</th> <th>Result</th> <th>SVC Action</th> </tr> </thead> <tbody> <tr> <td rowspan="2">(1) to (2)</td> <td>360 ~ 420Ω</td> <td>Explain</td> </tr> <tr> <td>Other</td> <td>Replace Water Valve</td> </tr> <tr> <td rowspan="2">(3) to (4)</td> <td>360 ~ 420Ω</td> <td>Explain</td> </tr> <tr> <td>Other</td> <td>Replace Water Valve</td> </tr> </tbody> </table>	Point	Result	SVC Action	(1) to (2)	360 ~ 420Ω	Explain	Other	Replace Water Valve	(3) to (4)	360 ~ 420Ω	Explain	Other	Replace Water Valve
Point	Result	SVC Action													
(1) to (2)	360 ~ 420Ω	Explain													
	Other	Replace Water Valve													
(3) to (4)	360 ~ 420Ω	Explain													
	Other	Replace Water Valve													

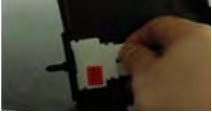
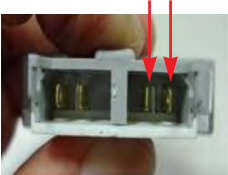

4) Freezer room Lamp doesn't work

No	Checking flow	Result & SVC Action													
1	<p>Check the Freezer door switch.</p> 	<p>If feel sticky, Change the door s/w.</p>													
2	<p>Check the <u>door S/W resistance.</u></p> 	<table border="1"> <thead> <tr> <th>Status</th> <th>Result</th> <th>SVC Action</th> </tr> </thead> <tbody> <tr> <td rowspan="2">Normal</td> <td>0Ω</td> <td>Go to the 3</td> </tr> <tr> <td>not</td> <td>Change door S/W</td> </tr> <tr> <td rowspan="2">Push S/W</td> <td>Infinity</td> <td>Go to the 3</td> </tr> <tr> <td></td> <td>Change door S/W</td> </tr> </tbody> </table>	Status	Result	SVC Action	Normal	0Ω	Go to the 3	not	Change door S/W	Push S/W	Infinity	Go to the 3		Change door S/W
Status	Result	SVC Action													
Normal	0Ω	Go to the 3													
	not	Change door S/W													
Push S/W	Infinity	Go to the 3													
		Change door S/W													
3	<p>Check the <u>Red/yellow to Pink.</u></p>  <p><CON11></p>	<table border="1"> <thead> <tr> <th>Status</th> <th>Result</th> <th>SVC Action</th> </tr> </thead> <tbody> <tr> <td rowspan="2">Normal</td> <td>12 VDC</td> <td>Go to the 4</td> </tr> <tr> <td>Other</td> <td>Change the PCB</td> </tr> </tbody> </table>	Status	Result	SVC Action	Normal	12 VDC	Go to the 4	Other	Change the PCB					
Status	Result	SVC Action													
Normal	12 VDC	Go to the 4													
	Other	Change the PCB													
4	<p>Check the <u>Red to Black.</u></p> 	<table border="1"> <thead> <tr> <th>Status</th> <th>Result</th> <th>SVC Action</th> </tr> </thead> <tbody> <tr> <td rowspan="2">Closed</td> <td>0 ~ 2 VDC</td> <td>Explain to customer</td> </tr> <tr> <td>Other</td> <td>Change the Door S/W</td> </tr> <tr> <td rowspan="2">Open</td> <td>12 VDC</td> <td>Explain to customer</td> </tr> <tr> <td>Other</td> <td>Change the LED Lamp</td> </tr> </tbody> </table>	Status	Result	SVC Action	Closed	0 ~ 2 VDC	Explain to customer	Other	Change the Door S/W	Open	12 VDC	Explain to customer	Other	Change the LED Lamp
Status	Result	SVC Action													
Closed	0 ~ 2 VDC	Explain to customer													
	Other	Change the Door S/W													
Open	12 VDC	Explain to customer													
	Other	Change the LED Lamp													



5) Refrigerator room lamp doesn't work

No	Checking flow	Result & SVC Action													
1	<p>Check the Refrigerator door switch.</p> 	<p>If feel sticky, Change the door s/w.</p>													
2	<p>Check the <u>door S/W</u> resistance.</p> 	<table border="1"> <thead> <tr> <th>Status</th> <th>Result</th> <th>SVC Action</th> </tr> </thead> <tbody> <tr> <td rowspan="2">Normal</td> <td>0Ω</td> <td>Go to the 3</td> </tr> <tr> <td>Other</td> <td>Change door S/W</td> </tr> <tr> <td rowspan="2">Push S/W</td> <td>Infinity</td> <td>Go to the 3</td> </tr> <tr> <td>Other</td> <td>Change door S/W</td> </tr> </tbody> </table>	Status	Result	SVC Action	Normal	0Ω	Go to the 3	Other	Change door S/W	Push S/W	Infinity	Go to the 3	Other	Change door S/W
Status	Result	SVC Action													
Normal	0Ω	Go to the 3													
	Other	Change door S/W													
Push S/W	Infinity	Go to the 3													
	Other	Change door S/W													
3	<p>Check the <u>Red/yellow to Pink.</u></p>  <p><CON11></p>	<table border="1"> <thead> <tr> <th>Status</th> <th>Result</th> <th>SVC Action</th> </tr> </thead> <tbody> <tr> <td rowspan="2">Normal</td> <td>12 V</td> <td>Go to the 4</td> </tr> <tr> <td>Other</td> <td>Change the PCB</td> </tr> </tbody> </table>	Status	Result	SVC Action	Normal	12 V	Go to the 4	Other	Change the PCB					
Status	Result	SVC Action													
Normal	12 V	Go to the 4													
	Other	Change the PCB													
4	<p>Check the <u>Red to Black.</u></p> 	<table border="1"> <thead> <tr> <th>Status</th> <th>Result</th> <th>SVC Action</th> </tr> </thead> <tbody> <tr> <td rowspan="2">Normal</td> <td>12 V</td> <td>Go to the 5</td> </tr> <tr> <td>Other</td> <td>Change the LED Lamp</td> </tr> </tbody> </table>	Status	Result	SVC Action	Normal	12 V	Go to the 5	Other	Change the LED Lamp					
Status	Result	SVC Action													
Normal	12 V	Go to the 5													
	Other	Change the LED Lamp													
5	<p>Check the <u>Black to Blue.</u></p> 	<table border="1"> <thead> <tr> <th>Status</th> <th>Result</th> <th>SVC Action</th> </tr> </thead> <tbody> <tr> <td rowspan="2">Closed</td> <td>0 ~ 2 V</td> <td>Explain to customer</td> </tr> <tr> <td>Other</td> <td>Change the Door S/W</td> </tr> <tr> <td rowspan="2">Open</td> <td>12 V</td> <td>Explain to customer</td> </tr> <tr> <td>Other</td> <td>Change the LED Lamp</td> </tr> </tbody> </table>	Status	Result	SVC Action	Closed	0 ~ 2 V	Explain to customer	Other	Change the Door S/W	Open	12 V	Explain to customer	Other	Change the LED Lamp
Status	Result	SVC Action													
Closed	0 ~ 2 V	Explain to customer													
	Other	Change the Door S/W													
Open	12 V	Explain to customer													
	Other	Change the LED Lamp													



6) Poor cooling in Fresh food section

No	Checking flow	Result & SVC Action												
1	<p>Check the sensor resistance.</p>  <p><CON11></p> <p>※ The sensor is determined by the temperature. For example, 30kΩ indicates 32°F.</p>	<table border="1"> <thead> <tr> <th>Temperature</th> <th>Result</th> </tr> </thead> <tbody> <tr> <td>23°F / -5°C</td> <td>38 kΩ</td> </tr> <tr> <td>32°F / 0°C</td> <td>30 kΩ</td> </tr> <tr> <td>41°F / 5°C</td> <td>24 kΩ</td> </tr> <tr> <td>50°F / 10°C</td> <td>19.5 kΩ</td> </tr> <tr> <td>59°F / 15°C</td> <td>16 kΩ</td> </tr> </tbody> </table>	Temperature	Result	23°F / -5°C	38 kΩ	32°F / 0°C	30 kΩ	41°F / 5°C	24 kΩ	50°F / 10°C	19.5 kΩ	59°F / 15°C	16 kΩ
Temperature	Result													
23°F / -5°C	38 kΩ													
32°F / 0°C	30 kΩ													
41°F / 5°C	24 kΩ													
50°F / 10°C	19.5 kΩ													
59°F / 15°C	16 kΩ													
2	<p>Reset the unit and Input Test 1 Mode. (push the button 1 time)</p>													
3	<p>Open the fresh food door and Check the air flow.</p> 	<table border="1"> <thead> <tr> <th>Status</th> <th>SVC Action</th> </tr> </thead> <tbody> <tr> <td>Windy</td> <td>Go to the 4</td> </tr> <tr> <td>No windy</td> <td>Check the R Fan motor Check the damper (Go to the 6)</td> </tr> </tbody> </table>	Status	SVC Action	Windy	Go to the 4	No windy	Check the R Fan motor Check the damper (Go to the 6)						
Status	SVC Action													
Windy	Go to the 4													
No windy	Check the R Fan motor Check the damper (Go to the 6)													
4	<p>Check the air temperature. Cold or not?</p>	<table border="1"> <thead> <tr> <th>Status</th> <th>SVC Action</th> </tr> </thead> <tbody> <tr> <td>Cold</td> <td>Explain to customer</td> </tr> <tr> <td>Not cold</td> <td>Check the Compressor And sealed system</td> </tr> </tbody> </table>	Status	SVC Action	Cold	Explain to customer	Not cold	Check the Compressor And sealed system						
Status	SVC Action													
Cold	Explain to customer													
Not cold	Check the Compressor And sealed system													

7) Poor cooling in Fresh food section

No	Checking flow	Result & SVC Action																								
5	<p>Damper checking method. Inputting TEST Mode, Check the damper and PCB.</p> 	<table border="1" data-bbox="883 480 1446 753"> <thead> <tr> <th>Test Mode</th> <th>Damper state</th> <th>SVC Action</th> </tr> </thead> <tbody> <tr> <td>1 Mode</td> <td>Open</td> <td rowspan="2">Damper is normal. (Check the</td> </tr> <tr> <td>2 Mode</td> <td>Closed</td> </tr> <tr> <td>1,2 mode</td> <td>Not working</td> <td>Change the damper</td> </tr> </tbody> </table> <table border="1" data-bbox="883 800 1446 1044"> <thead> <tr> <th>Test Point</th> <th>Result</th> <th>SVC Action</th> </tr> </thead> <tbody> <tr> <td rowspan="2">(1) to (2)</td> <td>270 ~330 Ω</td> <td>It's normal</td> </tr> <tr> <td>Other</td> <td>Change damper</td> </tr> <tr> <td rowspan="2">(3) to (4)</td> <td>270 ~330 Ω</td> <td>It's normal</td> </tr> <tr> <td>Other</td> <td>Change damper</td> </tr> </tbody> </table>	Test Mode	Damper state	SVC Action	1 Mode	Open	Damper is normal. (Check the	2 Mode	Closed	1,2 mode	Not working	Change the damper	Test Point	Result	SVC Action	(1) to (2)	270 ~330 Ω	It's normal	Other	Change damper	(3) to (4)	270 ~330 Ω	It's normal	Other	Change damper
Test Mode	Damper state	SVC Action																								
1 Mode	Open	Damper is normal. (Check the																								
2 Mode	Closed																									
1,2 mode	Not working	Change the damper																								
Test Point	Result	SVC Action																								
(1) to (2)	270 ~330 Ω	It's normal																								
	Other	Change damper																								
(3) to (4)	270 ~330 Ω	It's normal																								
	Other	Change damper																								
6	<p>Check the Fan motor. Rotate fan using your hand. It feel sticky, change the motor. (cause of ice or rust inside of motor)</p> 	<table border="1" data-bbox="883 1125 1446 1215"> <thead> <tr> <th>Point</th> <th>Result</th> <th>SVC Action</th> </tr> </thead> <tbody> <tr> <td>Motor</td> <td>Sticky</td> <td>Change the motor</td> </tr> </tbody> </table>	Point	Result	SVC Action	Motor	Sticky	Change the motor																		
Point	Result	SVC Action																								
Motor	Sticky	Change the motor																								
7	<p>Check the R Fan motor voltage.</p>  <p>(3)(2)(1) <CON10></p>	<table border="1" data-bbox="883 1508 1446 1651"> <thead> <tr> <th>Point</th> <th>Result</th> <th>SVC Action</th> </tr> </thead> <tbody> <tr> <td>(1)~(2)</td> <td>Below 12 V</td> <td>Change the PCB</td> </tr> <tr> <td>(1)~(3)</td> <td>0 or 5 V</td> <td>Change the motor</td> </tr> </tbody> </table>	Point	Result	SVC Action	(1)~(2)	Below 12 V	Change the PCB	(1)~(3)	0 or 5 V	Change the motor															
Point	Result	SVC Action																								
(1)~(2)	Below 12 V	Change the PCB																								
(1)~(3)	0 or 5 V	Change the motor																								





8) Poor cooling in Freezer compartment

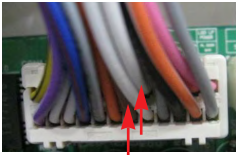
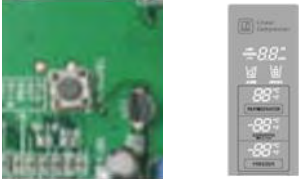
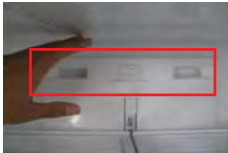
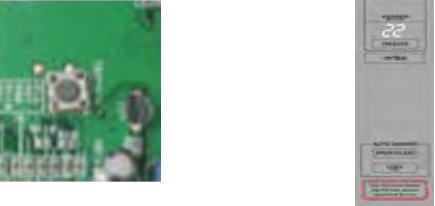
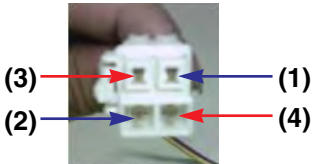

No	Checking flow	Result & SVC Action																
1	<p>Check the sensor resistance.</p>  <p><CON11></p> <p>※ The sensor is determined by the temperature. For example, 23kΩ indicates -4°F.</p>	<table border="1"> <thead> <tr> <th data-bbox="943 478 1159 527">(1) To (2)</th> <th data-bbox="1159 478 1373 527">Result</th> </tr> </thead> <tbody> <tr> <td data-bbox="943 527 1159 576">-22°F / -30°C</td> <td data-bbox="1159 527 1373 576">40 kΩ</td> </tr> <tr> <td data-bbox="943 576 1159 625">-13°F / -25°C</td> <td data-bbox="1159 576 1373 625">30 kΩ</td> </tr> <tr> <td data-bbox="943 625 1159 674">-4°F / -20°C</td> <td data-bbox="1159 625 1373 674">23 kΩ</td> </tr> <tr> <td data-bbox="943 674 1159 723">5°F / -15°C</td> <td data-bbox="1159 674 1373 723">17 kΩ</td> </tr> <tr> <td data-bbox="943 723 1159 772">14°F / -10°C</td> <td data-bbox="1159 723 1373 772">13 kΩ</td> </tr> <tr> <td data-bbox="943 772 1159 821">23°F / -5°C</td> <td data-bbox="1159 772 1373 821">10 kΩ</td> </tr> <tr> <td data-bbox="943 821 1159 870">32°F / 0°C</td> <td data-bbox="1159 821 1373 870">8 kΩ</td> </tr> </tbody> </table>	(1) To (2)	Result	-22°F / -30°C	40 kΩ	-13°F / -25°C	30 kΩ	-4°F / -20°C	23 kΩ	5°F / -15°C	17 kΩ	14°F / -10°C	13 kΩ	23°F / -5°C	10 kΩ	32°F / 0°C	8 kΩ
(1) To (2)	Result																	
-22°F / -30°C	40 kΩ																	
-13°F / -25°C	30 kΩ																	
-4°F / -20°C	23 kΩ																	
5°F / -15°C	17 kΩ																	
14°F / -10°C	13 kΩ																	
23°F / -5°C	10 kΩ																	
32°F / 0°C	8 kΩ																	
2	<p>Reset the unit and Input Test 1 Mode. (push the button 1 time)</p>																	
3	<p>Open the freezer door and Check the air flow.</p> 	<table border="1"> <thead> <tr> <th data-bbox="928 1495 1089 1544">Status</th> <th data-bbox="1089 1495 1408 1544">SVC Action</th> </tr> </thead> <tbody> <tr> <td data-bbox="928 1544 1089 1593">Windy</td> <td data-bbox="1089 1544 1408 1593">Go to the 4</td> </tr> <tr> <td data-bbox="928 1593 1089 1642">No windy</td> <td data-bbox="1089 1593 1408 1642">Check the F Fan motor</td> </tr> </tbody> </table>	Status	SVC Action	Windy	Go to the 4	No windy	Check the F Fan motor										
Status	SVC Action																	
Windy	Go to the 4																	
No windy	Check the F Fan motor																	
4	<p>Check the air temperature. Cold or not ?</p>	<table border="1"> <thead> <tr> <th data-bbox="928 1789 1089 1838">Status</th> <th data-bbox="1089 1789 1408 1838">SVC Action</th> </tr> </thead> <tbody> <tr> <td data-bbox="928 1838 1089 1887">Cold</td> <td data-bbox="1089 1838 1408 1887">Explain to customer</td> </tr> <tr> <td data-bbox="928 1887 1089 1964">Not cold</td> <td data-bbox="1089 1887 1408 1964">Check the Compressor And sealed system</td> </tr> </tbody> </table>	Status	SVC Action	Cold	Explain to customer	Not cold	Check the Compressor And sealed system										
Status	SVC Action																	
Cold	Explain to customer																	
Not cold	Check the Compressor And sealed system																	

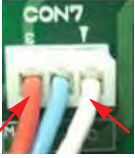
9) Over cooling in Fresh food compartment

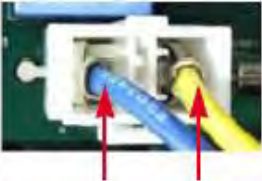
No	Checking flow	Result & SVC Action													
1	<p>Check the sensor resistance.</p>  <p><CON11></p> <p>※ The sensor is determined by the temperature. For example, 30kΩ indicates 32°F.</p>	<table border="1"> <thead> <tr> <th>Temperature</th> <th>Result</th> </tr> </thead> <tbody> <tr> <td>23°F / -5°C</td> <td>38 kΩ</td> </tr> <tr> <td>32°F / 0°C</td> <td>30 kΩ</td> </tr> <tr> <td>41°F / 5°C</td> <td>24 kΩ</td> </tr> <tr> <td>50°F / 10°C</td> <td>19.5 kΩ</td> </tr> <tr> <td>59°F / 15°C</td> <td>16 kΩ</td> </tr> </tbody> </table>	Temperature	Result	23°F / -5°C	38 kΩ	32°F / 0°C	30 kΩ	41°F / 5°C	24 kΩ	50°F / 10°C	19.5 kΩ	59°F / 15°C	16 kΩ	
Temperature	Result														
23°F / -5°C	38 kΩ														
32°F / 0°C	30 kΩ														
41°F / 5°C	24 kΩ														
50°F / 10°C	19.5 kΩ														
59°F / 15°C	16 kΩ														
2	<p>Reset the unit and Input Test 1 Mode. (push the button 1 time)</p>														
3	<p>Open the refrigerator door and Check the air flow.</p> 	<table border="1"> <thead> <tr> <th>Status</th> <th>SVC Action</th> </tr> </thead> <tbody> <tr> <td>Windy</td> <td>Go to the 4</td> </tr> <tr> <td>No windy</td> <td>Check the R Fan Check the damper (Go to the 5)</td> </tr> </tbody> </table>	Status	SVC Action	Windy	Go to the 4	No windy	Check the R Fan Check the damper (Go to the 5)							
Status	SVC Action														
Windy	Go to the 4														
No windy	Check the R Fan Check the damper (Go to the 5)														
4	<p>Input Test 2 Mode and Check the air flow. (push the button 1 time)</p> 	<table border="1"> <thead> <tr> <th>Status</th> <th>SVC Action</th> </tr> </thead> <tbody> <tr> <td>Windy</td> <td>Go to the 5</td> </tr> <tr> <td>No windy</td> <td>It's normal</td> </tr> </tbody> </table>	Status	SVC Action	Windy	Go to the 5	No windy	It's normal							
Status	SVC Action														
Windy	Go to the 5														
No windy	It's normal														
5	<p>Check the damper resistance.</p> 	<table border="1"> <thead> <tr> <th>Point</th> <th>Result</th> <th>SVC Action</th> </tr> </thead> <tbody> <tr> <td rowspan="2">(1) to (2)</td> <td>270 ~330Ω</td> <td>It's normal</td> </tr> <tr> <td>Other</td> <td>Change damper</td> </tr> <tr> <td rowspan="2">(3) to (4)</td> <td>270 ~330Ω</td> <td>It's normal</td> </tr> <tr> <td>Other</td> <td>Change damper</td> </tr> </tbody> </table>	Point	Result	SVC Action	(1) to (2)	270 ~330Ω	It's normal	Other	Change damper	(3) to (4)	270 ~330Ω	It's normal	Other	Change damper
Point	Result	SVC Action													
(1) to (2)	270 ~330Ω	It's normal													
	Other	Change damper													
(3) to (4)	270 ~330Ω	It's normal													
	Other	Change damper													

10) Lower auto drawer doesn't work

No	Checking flow	Result & SVC Action								
1	<p>Check the Red to White. (Main PCB)</p>  <p><CON4></p>	<table border="1"> <thead> <tr> <th>Status</th> <th>Result</th> <th>SVC Action</th> </tr> </thead> <tbody> <tr> <td rowspan="2">Normal</td> <td>5 V</td> <td>Go to the 2</td> </tr> <tr> <td>Other</td> <td>Change the PCB</td> </tr> </tbody> </table>	Status	Result	SVC Action	Normal	5 V	Go to the 2	Other	Change the PCB
Status	Result	SVC Action								
Normal	5 V	Go to the 2								
	Other	Change the PCB								
2	<p>Check the Red to White. (Auto PCB)</p>  <p><CON7></p>	<table border="1"> <thead> <tr> <th>Status</th> <th>Result</th> <th>SVC Action</th> </tr> </thead> <tbody> <tr> <td rowspan="2">Normal</td> <td>5 V</td> <td>Go to the 3</td> </tr> <tr> <td>Other</td> <td>Change the Auto Drawer PCB</td> </tr> </tbody> </table>	Status	Result	SVC Action	Normal	5 V	Go to the 3	Other	Change the Auto Drawer PCB
Status	Result	SVC Action								
Normal	5 V	Go to the 3								
	Other	Change the Auto Drawer PCB								
3	<p>Check the Yellow to Blue. (Main PCB)</p>  <p><CON3></p>	<table border="1"> <thead> <tr> <th>Status</th> <th>Result</th> <th>SVC Action</th> </tr> </thead> <tbody> <tr> <td rowspan="2">Normal</td> <td>115V</td> <td>Go to the 4</td> </tr> <tr> <td>Other</td> <td>Change the PCB</td> </tr> </tbody> </table>	Status	Result	SVC Action	Normal	115V	Go to the 4	Other	Change the PCB
Status	Result	SVC Action								
Normal	115V	Go to the 4								
	Other	Change the PCB								
4	<p>Check the Yellow to Blue. (Auto PCB)</p>  <p><CON1></p>	<table border="1"> <thead> <tr> <th>Status</th> <th>Result</th> <th>SVC Action</th> </tr> </thead> <tbody> <tr> <td rowspan="2">Normal</td> <td>115V</td> <td>Go to the 5</td> </tr> <tr> <td>Other</td> <td>Replace product</td> </tr> </tbody> </table>	Status	Result	SVC Action	Normal	115V	Go to the 5	Other	Replace product
Status	Result	SVC Action								
Normal	115V	Go to the 5								
	Other	Replace product								
5	<p>Check the Red to Bright Orange.</p>  <p><CON2></p>	<table border="1"> <thead> <tr> <th>Status</th> <th>Result</th> <th>SVC Action</th> </tr> </thead> <tbody> <tr> <td rowspan="2">Normal</td> <td>5 V</td> <td>Go to the 6</td> </tr> <tr> <td>Other</td> <td>Change the Auto Drawer PCB</td> </tr> </tbody> </table>	Status	Result	SVC Action	Normal	5 V	Go to the 6	Other	Change the Auto Drawer PCB
Status	Result	SVC Action								
Normal	5 V	Go to the 6								
	Other	Change the Auto Drawer PCB								

No	Checking flow	Result & SVC Action								
6	<p data-bbox="298 463 768 495">Check the Red to Yellow. (Auto PCB)</p>  <p data-bbox="464 676 573 708"><CON2></p>	<table border="1" data-bbox="886 474 1446 644"> <thead> <tr> <th data-bbox="886 474 1024 517">Status</th> <th data-bbox="1024 474 1198 517">Result</th> <th data-bbox="1198 474 1446 517">SVC Action</th> </tr> </thead> <tbody> <tr> <td data-bbox="886 517 1024 644" rowspan="2">Normal</td> <td data-bbox="1024 517 1198 559">0~5 V</td> <td data-bbox="1198 517 1446 559">Go to the 7</td> </tr> <tr> <td data-bbox="1024 559 1198 644">Other</td> <td data-bbox="1198 559 1446 644">Change the Auto Drawer Motor</td> </tr> </tbody> </table>	Status	Result	SVC Action	Normal	0~5 V	Go to the 7	Other	Change the Auto Drawer Motor
Status	Result	SVC Action								
Normal	0~5 V	Go to the 7								
	Other	Change the Auto Drawer Motor								
7	<p data-bbox="298 789 743 821">Check the Red to Blue. (Auto PCB)</p>  <p data-bbox="464 1012 573 1044"><CON2></p>	<table border="1" data-bbox="886 800 1446 970"> <thead> <tr> <th data-bbox="886 800 1024 842">Status</th> <th data-bbox="1024 800 1198 842">Result</th> <th data-bbox="1198 800 1446 842">SVC Action</th> </tr> </thead> <tbody> <tr> <td data-bbox="886 842 1024 970" rowspan="2">Normal</td> <td data-bbox="1024 842 1198 885">0~5 V</td> <td data-bbox="1198 842 1446 885">Go to the 8</td> </tr> <tr> <td data-bbox="1024 885 1198 970">Other</td> <td data-bbox="1198 885 1446 970">Change the Auto Drawer Motor</td> </tr> </tbody> </table>	Status	Result	SVC Action	Normal	0~5 V	Go to the 8	Other	Change the Auto Drawer Motor
Status	Result	SVC Action								
Normal	0~5 V	Go to the 8								
	Other	Change the Auto Drawer Motor								
8	<p data-bbox="298 1119 760 1151">Check the Red to Purple (Main PCB)</p>  <p data-bbox="464 1342 573 1374"><CON2></p>	<table border="1" data-bbox="886 1129 1446 1300"> <thead> <tr> <th data-bbox="886 1129 1024 1172">Status</th> <th data-bbox="1024 1129 1198 1172">Result</th> <th data-bbox="1198 1129 1446 1172">SVC Action</th> </tr> </thead> <tbody> <tr> <td data-bbox="886 1172 1024 1300" rowspan="2">Normal</td> <td data-bbox="1024 1172 1198 1215">0~5 V</td> <td data-bbox="1198 1172 1446 1215">Go to the 8</td> </tr> <tr> <td data-bbox="1024 1215 1198 1300">Other</td> <td data-bbox="1198 1215 1446 1300">Change the Auto Drawer Motor</td> </tr> </tbody> </table>	Status	Result	SVC Action	Normal	0~5 V	Go to the 8	Other	Change the Auto Drawer Motor
Status	Result	SVC Action								
Normal	0~5 V	Go to the 8								
	Other	Change the Auto Drawer Motor								

7. Reference

4. Reference

1) TEST MODE and Removing TPA

1. How to make TEST MODE

If you push the test button on the Main PCB, the refrigerator will be enter the TEST MODE

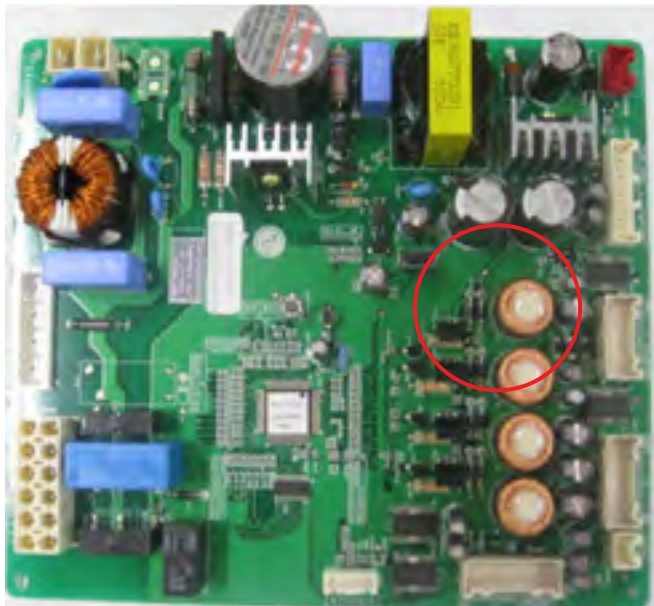

Main PWB

* 1 time : Comp / Damper / All FAN on
(All things displayed)



* 2 times : Damper closed
(22 22 displayed)



* 3 times : Forced defrost mode
(33 33 displayed)



2. How to remove Terminal Position Assurance (TPA)

<AC TPA>

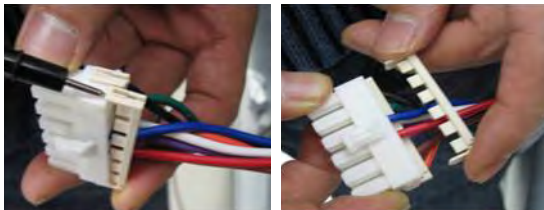

<DC TPA>

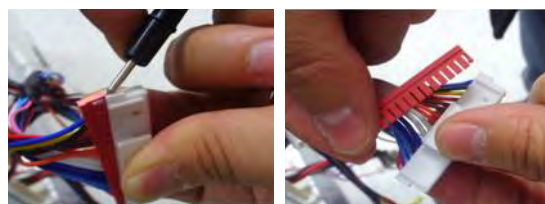

※ After measure the values, you should put in the TPA again.

2) TEMPERATRUE CHART - FRZ AND ICING SENSOR

TEMP	RESISTANCE	VOLTAGE
-39°F(-40°C)	73.29 kΩ	4.09 V
-30°F(-35°C)	53.63 kΩ	3.84 V
-30°F(-21°C)	39.66 kΩ	3.55 V
-13°F(-25°C)	29.62 kΩ	3.23 V
-4°F(-20°C)	22.33 kΩ	2.89 V
5°F(-15°C)	16.99 kΩ	2.56 V
14°F(-10°C)	13.05 kΩ	2.23 V
23°F(-5°C)	10.10 kΩ	1.92 V
32°F(0°C)	7.88 kΩ	1.63 V
41°F(+5°C)	6.19 kΩ	1.38 V
50°F(+10°C)	4.91 kΩ	1.16 V
59°F(+15°C)	3.91 kΩ	0.97 V
68°F(+20°C)	3.14 kΩ	0.81 V
77°F(+25°C)	2.54 kΩ	0.67 V
86°F(+30°C)	2.07 kΩ	0.56 V
95°F(+35°C)	1.69 kΩ	0.47 V
104°F(+40°C)	1.39 kΩ	0.39 V

3) TEMPERATRUE CHART - REF AND DEF SENSOR

RESISTANCE	RESISTANCE	VOLTAGE
-39°F(-40°C)	225.1 kΩ	4.48 V
-30°F(-35°C)	169.8 kΩ	4.33 V
-30°F(-21°C)	129.3 kΩ	4.16 V
-13°F(-25°C)	99.30 kΩ	3.95 V
-4°F(-20°C)	76.96 kΩ	3.734 V
5°F(-15°C)	60.13 kΩ	3.487 V
14°F(-10°C)	47.34 kΩ	3.22 V
23°F(-5°C)	37.55 kΩ	2.95 V
32°F(0°C)	30 kΩ	2.67 V
41°F(+5°C)	24.13 kΩ	2.40 V
50°F(+10°C)	19.53 kΩ	2.14 V
59°F(+15°C)	15.91 kΩ	1.89 V
68°F(+20°C)	13.03 kΩ	1.64 V
77°F(+25°C)	10.74 kΩ	1.45 V
86°F(+30°C)	8.89 kΩ	1.27 V
95°F(+35°C)	7.40 kΩ	1.10 V
104°F(+40°C)	6.20 kΩ	0.96 V

10-4 How to check the Fan-Error

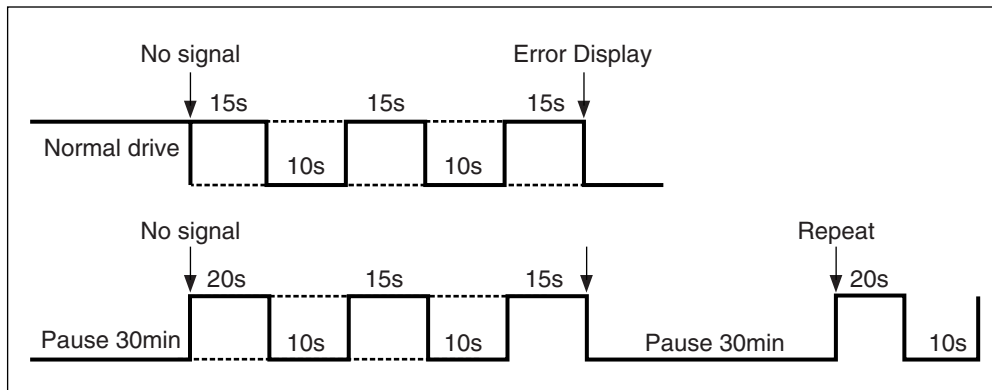

(1) EBR650027**

After sending a signal to the fan, the MICOM checks the BLDC fan motor's lock status. If there is no feedback signal from the BLDC fan, the fan motor stops for 10 seconds and then is powered again for 15 seconds. To determine that there is a fan motor malfunction, this process is repeated 3 times. If the fan motor is determined to be defective, the error code will be shown in the display for 30 minutes. At this point, the process will be repeated until the fan motor operates normally. If normal operation is achieved, the error display is erased and the MICOM is reset automatically.



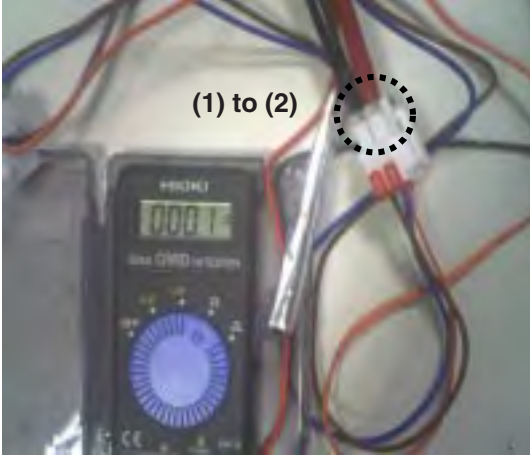

8. COMPONENT TESTING INFORMATION

8-1 Defrost Controller Assembly

<p>Function</p>	<p>The controller assembly is made up of two different kinds of parts. The fuse and the sensor. To determine if these parts are defective, check for resistance. The fuse will cut power to the defrost heater at very high temperatures.</p>									
<p>How to Measure (Fuse-M)</p>		<p>Set a ohmmeter to the 2 housing pin. Measure the 2 pin connected to Fuse-M. If the ohmmeter indicate below 0.1ohm fuse-m is a good condition, But if infinite the part is bad.</p>								
<p>How to Measure (Sensor)</p>		<p>Set a ohmmeter to The 2housing pin. Measure the 2 pin connected to Sensor. If the ohmmeter indicate 11kΩ (at room temperature) Sensor is good. When check the ohm at other temperatures Check the sensor manual.</p>								
<p>Standard</p>	<p style="text-align: center;">Fuse-M (at all temperature)</p> <table border="1" style="margin-left: auto; margin-right: auto;"> <thead> <tr> <th>Test Point</th> <th>Ressult</th> </tr> </thead> <tbody> <tr> <td>(1) to (2)</td> <td>0 ~ 0.1Ω</td> </tr> </tbody> </table>	Test Point	Ressult	(1) to (2)	0 ~ 0.1Ω	<p style="text-align: center;">Sensor (at room temperature)</p> <table border="1" style="margin-left: auto; margin-right: auto;"> <thead> <tr> <th>Test Point</th> <th>Ressult</th> </tr> </thead> <tbody> <tr> <td>(1) to (2)</td> <td>11Ω</td> </tr> </tbody> </table>	Test Point	Ressult	(1) to (2)	11Ω
Test Point	Ressult									
(1) to (2)	0 ~ 0.1Ω									
Test Point	Ressult									
(1) to (2)	11Ω									



8-2 Sheath Heater

<p>Function</p>	<p>Sheath heater is a part for defrost. All heating wire is connected to only one line. To check if the part is defective, check the resistance.</p>				
<p>How to Measure</p>	<div style="display: flex; justify-content: space-around;">   </div> <p style="text-align: center;">(1) (2)</p> <p>Set a ohmmeter connect to The 2 housing pin. Measure the 2 pin connected to Sheath Heater. If the ohmmeter indicate $(V^{\circ}\delta V)/Watt=R$ is good condition, ex) when watt=350w, voltage=115v $R=(115^{\circ}\delta 115)/350=38\Omega$ But if the ohm meter indicate infinity the Sheath heater is bad.</p>				
<p>Standard</p>	<p style="text-align: center;">Sheath heater (at all temperature)</p> <table border="1" style="margin-left: auto; margin-right: auto;"> <thead> <tr> <th>Test Point</th> <th>Ressult</th> </tr> </thead> <tbody> <tr> <td>(1) to (2)</td> <td>34 ~ 42Ω</td> </tr> </tbody> </table>	Test Point	Ressult	(1) to (2)	34 ~ 42Ω
Test Point	Ressult				
(1) to (2)	34 ~ 42Ω				

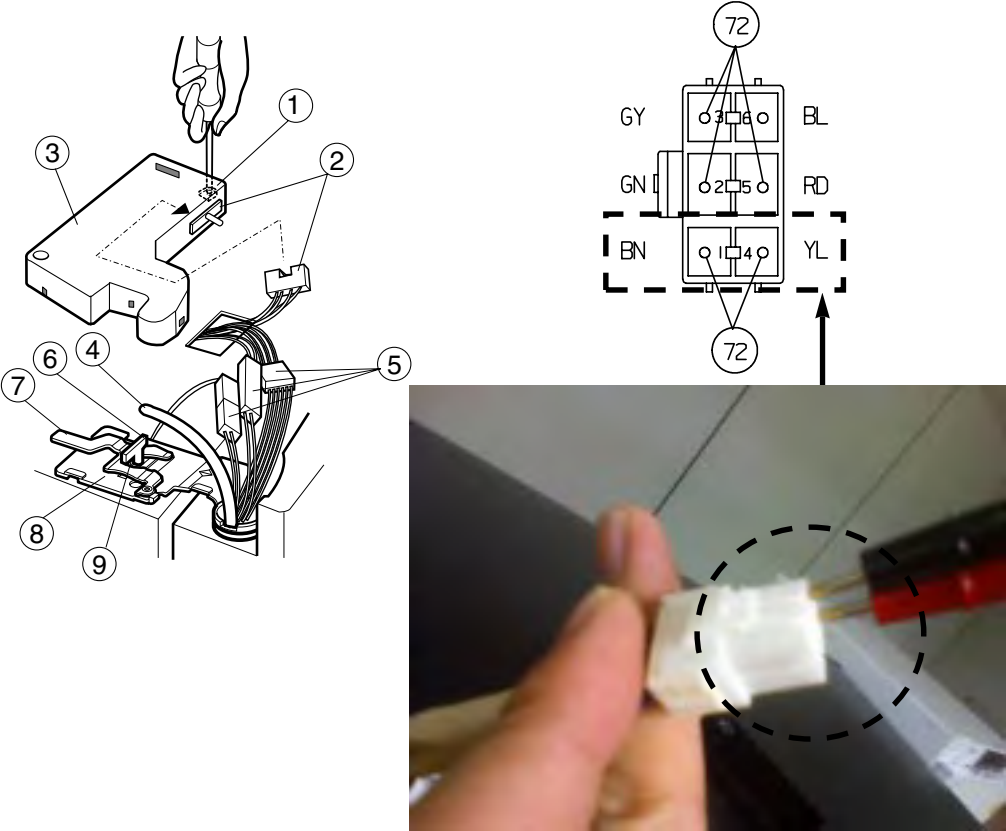
8-3 Mullion Heater Assembly

Function	The heater is designed to prevent the door from sweating.				
How to Measure	 <p>The diagram shows the assembly process with numbered callouts 1 through 9. Callout 1 points to a screw being inserted into the heater housing. Callout 2 points to a terminal on the heater. Callout 3 points to the heater housing. Callout 4 points to a cable connector. Callout 5 points to the cable wires. Callout 6 points to a terminal block. Callout 7 points to a terminal. Callout 8 points to a terminal. Callout 9 points to a terminal. The wiring diagram shows a terminal block with terminals labeled GY, GN, BN, BL, RD, and YL. Terminals 1, 2, and 4 are connected to a 72 ohm resistor. Terminal 5 is connected to terminal 2. Terminal 3 is connected to terminal 4. Terminal 6 is connected to terminal 4. Terminal 7 is connected to terminal 4. Terminal 8 is connected to terminal 4. Terminal 9 is connected to terminal 4. A photo shows a hand holding a white cable connector with a dashed circle around the terminal block.</p>				
Standard	<table border="1" data-bbox="420 1417 894 1513"> <thead> <tr> <th>Test Point</th> <th>Result</th> </tr> </thead> <tbody> <tr> <td>(1) to (2)</td> <td>1,913Ω ~ 2,201Ω</td> </tr> </tbody> </table>	Test Point	Result	(1) to (2)	1,913Ω ~ 2,201Ω
Test Point	Result				
(1) to (2)	1,913Ω ~ 2,201Ω				

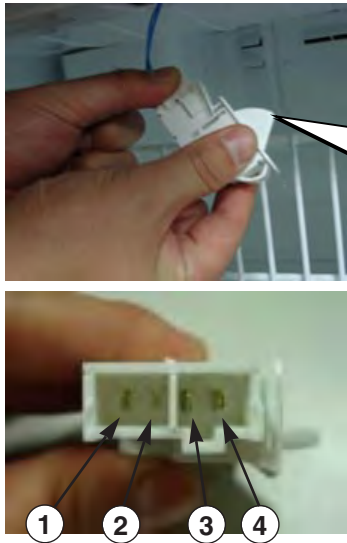
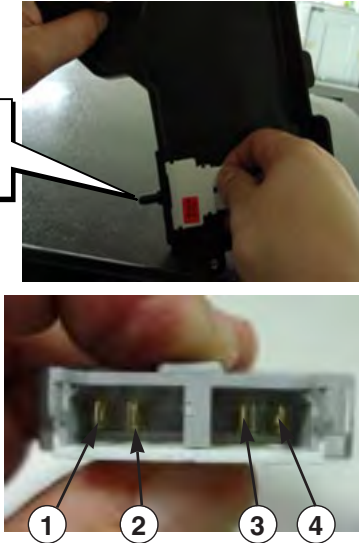
8-4 Door Switch

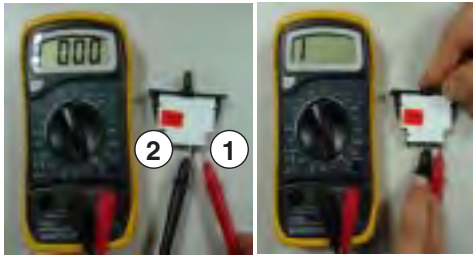
<p>Function</p>	<p>The switch senses if the door is open or closed.</p> <ul style="list-style-type: none"> - When the door open, lamp on. - When the door open, the switch give information to Micom. <p>When the door open, internal contact operate on and off moving plunger of door switch up and down.</p>				
<p>How to Measure</p>	<div style="display: flex; justify-content: space-around;"> <div style="text-align: center;"> <p><Switch, Freezer></p>  </div> <div style="text-align: center;"> <p><Switch, Refrigerator></p>  </div> </div> <div style="display: flex; justify-content: space-around; margin-top: 10px;"> <div style="text-align: center;">  <p>Beep</p> </div> <div style="text-align: center;">  <p>Beep</p> </div> </div> <p>Check the resistance between connectors 1, 2 and 3, 4 .It means check whether or not applying an electric current. If there is resistance, the switch is good.</p>				
<p>Standard</p>	<p style="text-align: center;">Multimeter beep – Switch F,R</p> <table border="1" style="margin-left: auto; margin-right: auto;"> <tr> <td style="padding: 5px;">Nomal</td> <td style="padding: 5px;">Push the button(Plunger)</td> </tr> <tr> <td style="padding: 5px;">Beep or 0Ω</td> <td style="padding: 5px;">None (∞ Ω)</td> </tr> </table>	Nomal	Push the button(Plunger)	Beep or 0Ω	None (∞ Ω)
Nomal	Push the button(Plunger)				
Beep or 0Ω	None (∞ Ω)				

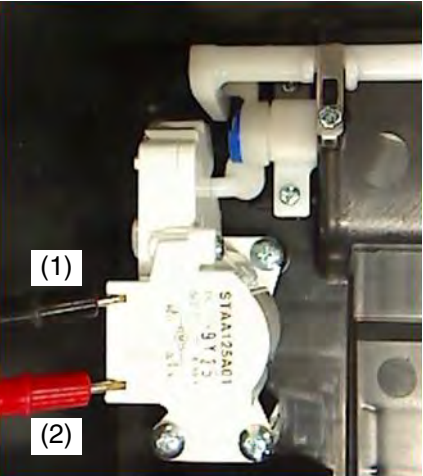

8-5 Dispenser DC Motor

Function	- Dispenser DC Motor : When customer push the dispenser button, Pull duct door and abstract from ice bank.						
How to Measure	<div style="text-align: center;">  <p>Dispenser DC Motor</p> </div>						
Standard	<table border="1" style="margin-left: auto; margin-right: auto;"> <thead> <tr> <th colspan="2" style="text-align: center;">Dispenser DC Motor</th> </tr> <tr> <th style="text-align: center;">Test Points</th> <th style="text-align: center;">Result</th> </tr> </thead> <tbody> <tr> <td style="text-align: center;">(1) to (2)</td> <td style="text-align: center;">9.9 ~ 12.1 Ω</td> </tr> </tbody> </table>	Dispenser DC Motor		Test Points	Result	(1) to (2)	9.9 ~ 12.1 Ω
Dispenser DC Motor							
Test Points	Result						
(1) to (2)	9.9 ~ 12.1 Ω						

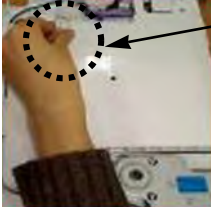
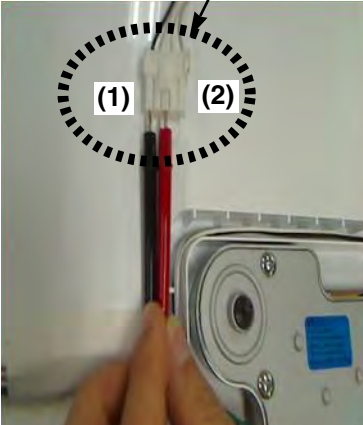
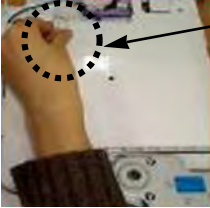
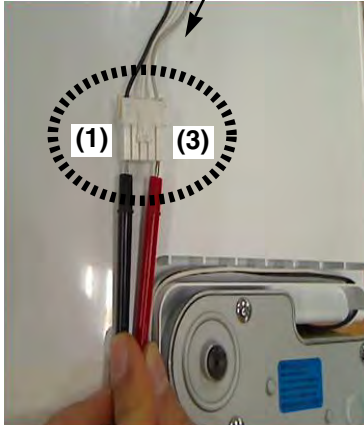

8-6 AC Motor ASSEMBLY

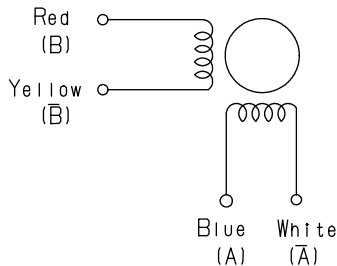
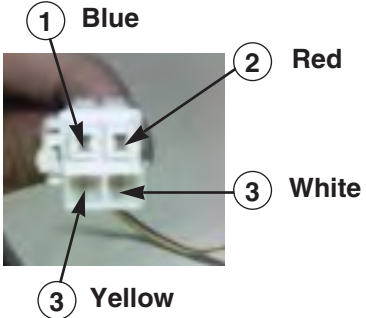
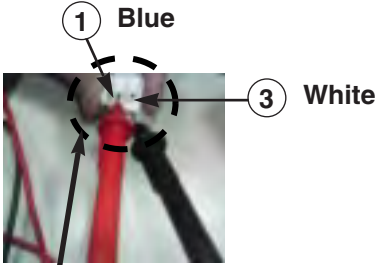
Function	The motor in the door pushed the ice into the dispenser.													
How to Measure	<p>< In-door Motor ></p>  <p>① Separate the housing.</p>  <p>② Measure the resistance between (1) and (2)</p>	<p>< In-door Motor ></p>  <p>① Separate the housing.</p>  <p>② Measure the resistance between (1) and (3)</p> <p>Check the resistance between connectors (In-door motor 1, 2) and (In-door motor 1, 3). It means check whether or not applying an Electric current. If there is resistance, it means the geared motor or solenoid is not inferiority</p>												
Standard	<table border="1" style="margin-left: auto; margin-right: auto;"> <thead> <tr> <th colspan="2" style="text-align: center;">Geared Motor</th> </tr> <tr> <th style="text-align: center;">Test Points</th> <th style="text-align: center;">Result</th> </tr> </thead> <tbody> <tr> <td style="text-align: center;">(1) to (2)</td> <td style="text-align: center;">31.1 ~ 42.09Ω</td> </tr> </tbody> </table>	Geared Motor		Test Points	Result	(1) to (2)	31.1 ~ 42.09Ω	<table border="1" style="margin-left: auto; margin-right: auto;"> <thead> <tr> <th colspan="2" style="text-align: center;">Cube Solenoid</th> </tr> <tr> <th style="text-align: center;">Test Points</th> <th style="text-align: center;">Result</th> </tr> </thead> <tbody> <tr> <td style="text-align: center;">(1) to (3)</td> <td style="text-align: center;">31.1 ~ 42.09Ω</td> </tr> </tbody> </table>	Cube Solenoid		Test Points	Result	(1) to (3)	31.1 ~ 42.09Ω
Geared Motor														
Test Points	Result													
(1) to (2)	31.1 ~ 42.09Ω													
Cube Solenoid														
Test Points	Result													
(1) to (3)	31.1 ~ 42.09Ω													

8-7 Damper

<p>Function</p>	<p>The damper supplies cold air from the freezer to the chill room using the damper plate. The chill room is colder when the damper plate is open. When the damper is closed the chill rooms temperature will rise.</p>																													
<p>How to Measure</p>	<div style="border: 1px dashed black; padding: 10px;"> <p>Table(1): 결선도(Wiring)</p>  <p>Table(2): 2-2상 여자순서(CW Rotation)</p> <table border="1" data-bbox="873 563 1351 819"> <thead> <tr> <th rowspan="2">Housing No. & L/Wire Color</th> <th colspan="4">Step</th> </tr> <tr> <th>1</th> <th>2</th> <th>3</th> <th>4</th> </tr> </thead> <tbody> <tr> <td>1- Blue (A)</td> <td>+</td> <td>-</td> <td>-</td> <td>+</td> </tr> <tr> <td>2- Red (B)</td> <td>+</td> <td>+</td> <td>-</td> <td>-</td> </tr> <tr> <td>3- White(A)</td> <td>-</td> <td>+</td> <td>+</td> <td>-</td> </tr> <tr> <td>4- Yellow(B)</td> <td>-</td> <td>-</td> <td>+</td> <td>+</td> </tr> </tbody> </table> </div> <p style="text-align: center;">< Damper Circuit ></p> <div style="display: flex; justify-content: space-around;"> <div style="text-align: center;">  <p>Check the ②, ④</p> </div> <div style="text-align: center;">  <p>Check the ①, ③</p> </div> </div> <p style="text-align: center;">< extension ></p> <div style="display: flex; justify-content: space-around;"> <div style="text-align: center;">  <p>Check the ②, ④</p> </div> <div style="text-align: center;">  <p>Check the ①, ③</p> </div> </div> <p>Check to see if there is electrical current, if there is resistance the damper is good.</p>	Housing No. & L/Wire Color	Step				1	2	3	4	1- Blue (A)	+	-	-	+	2- Red (B)	+	+	-	-	3- White(A)	-	+	+	-	4- Yellow(B)	-	-	+	+
Housing No. & L/Wire Color	Step																													
	1	2	3	4																										
1- Blue (A)	+	-	-	+																										
2- Red (B)	+	+	-	-																										
3- White(A)	-	+	+	-																										
4- Yellow(B)	-	-	+	+																										
<p>Standard</p>	<p>Damper</p> <table border="1" data-bbox="365 1893 1364 2021"> <thead> <tr> <th>Test Points</th> <th>Main Damper</th> <th>Pantry Damper</th> <th>절환실 Damper</th> </tr> </thead> <tbody> <tr> <td>Red and Yellow</td> <td>270 ~ 330Ω</td> <td>270 ~ 330Ω</td> <td>373 ~ 457Ω</td> </tr> <tr> <td>Blue and White</td> <td>270 ~ 330Ω</td> <td>270 ~ 330Ω</td> <td>373 ~ 457Ω</td> </tr> </tbody> </table>	Test Points	Main Damper	Pantry Damper	절환실 Damper	Red and Yellow	270 ~ 330Ω	270 ~ 330Ω	373 ~ 457Ω	Blue and White	270 ~ 330Ω	270 ~ 330Ω	373 ~ 457Ω																	
Test Points	Main Damper	Pantry Damper	절환실 Damper																											
Red and Yellow	270 ~ 330Ω	270 ~ 330Ω	373 ~ 457Ω																											
Blue and White	270 ~ 330Ω	270 ~ 330Ω	373 ~ 457Ω																											

8-8 Flow Sensor

Function	Flow Sensor (in machine room) Count the water quantity from city water to water filter in refrigerator					
How to Measure	 <p style="text-align: center;">Flow Sensor (in machine room)</p>					
Standard	<table border="1" style="margin-left: auto; margin-right: auto;"> <thead> <tr> <th>Test Points</th> <th>Result</th> </tr> </thead> <tbody> <tr> <td>Red wire to Black wire</td> <td>4 ~ 30 kΩ</td> </tr> </tbody> </table>		Test Points	Result	Red wire to Black wire	4 ~ 30 kΩ
Test Points	Result					
Red wire to Black wire	4 ~ 30 kΩ					

9. TROUBLESHOOTING

PCB Check (Simplify)

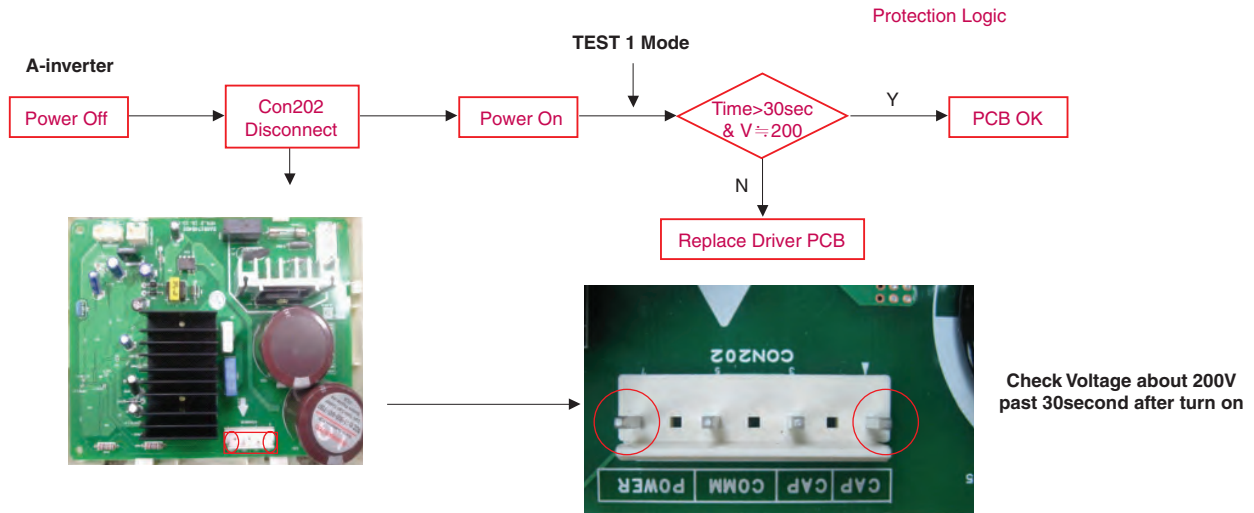

Test Mode

	Ref.	Comp	Display & sound	Refer
		FC75(A-Inverter)		
TEST1	Forced Starting	TDC (Full Stroke)	Display ON, Buzz 1 time	

Troubleshooting

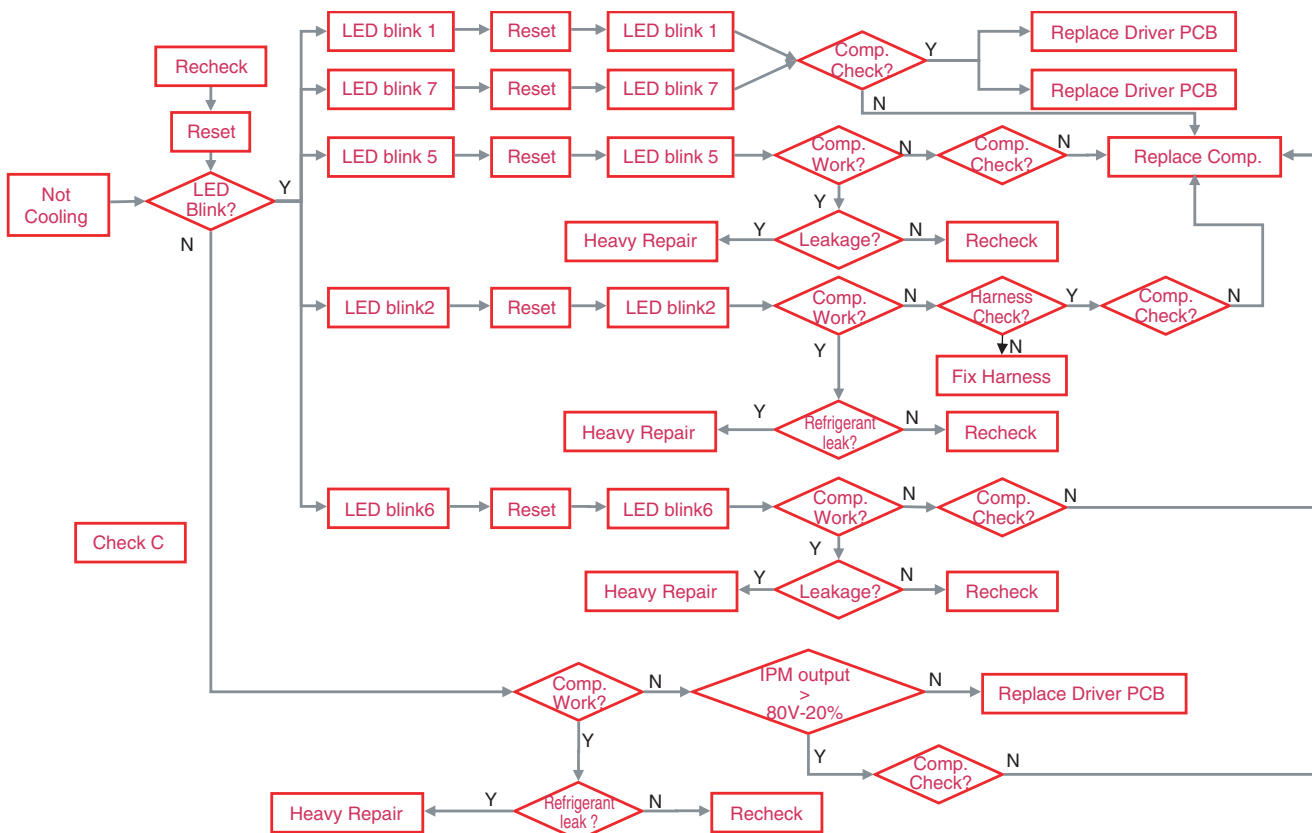

9-1 Check A

- There is PC Board located in the PCB case.
The control driver is PC board for the compressor.
- This step shows the source voltage of the driver PC board.

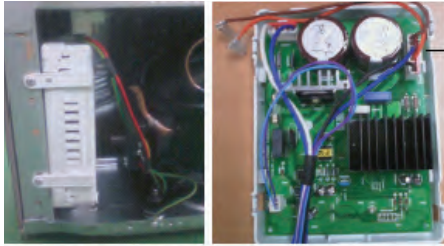

A-Inverter
FC75LBNA

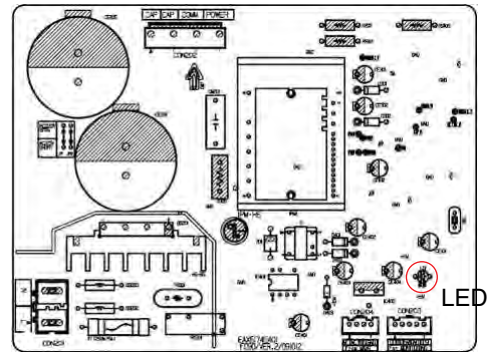

- * There is a PCB located in the PCB case next to the compressor. That is the driver PCB. the linear compressor.

- Visually inspect fuse and measure DC high voltage.
- Measure the DC low voltage that supplies the inverter circuit.

E-Inverter

Step 3. Check Fuse (visual inspection)

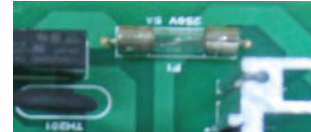

Step 4. Check DC High Voltage (Multi Tester) Spec. about 330V DC



⊙ GND
○ Voltage

Step 5 Check DC low voltage (Multi Tester)
Spec. A Point 15V
B Point 5V

Step 6 Check LED Blink
See Check B

IPM Output check

- Measure the voltage between the POWER and COMM pins of the connector as shown below.

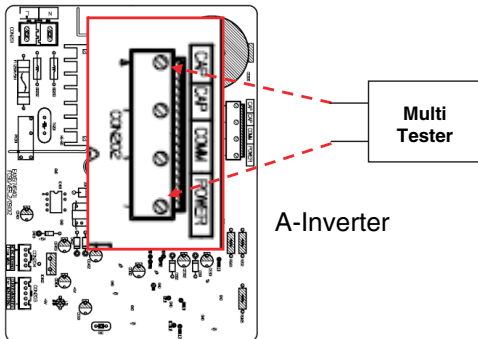

Check to make sure compressor is receiving voltage from IPM

- In order to determine whether the compressor is operating normally, check the output voltage during the refrigeration cycle.
- After initial power-up, when the compressor begins to operate, wait 10 minutes before checking.
- The compressor is operating normally if the voltage is greater than 80V.

9-2 Check B

B1. LED blinks once, then repeats (FCT0 Fault: A-Inverter)

Protection Logic



Blink OFF Blink OFF

- Purpose: Detecting motor current and voltage error
- Check voltage at **point A** (Motor Voltage), **point B** (Motor Current) and **Point C** (Capacitor Voltage) when **compressor is off**.
- Spec: **Points A, B, & C $2.5V \pm 0.3V$**
- Logic: Compressor is forced to off and will try to restart after 20 seconds.

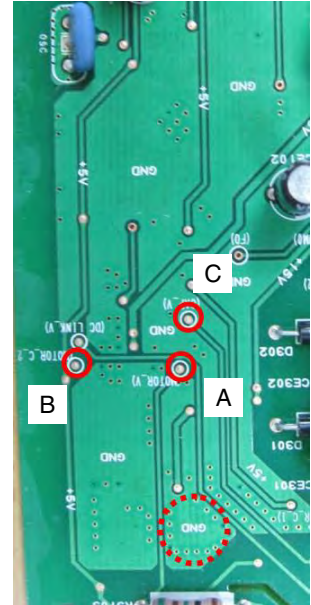
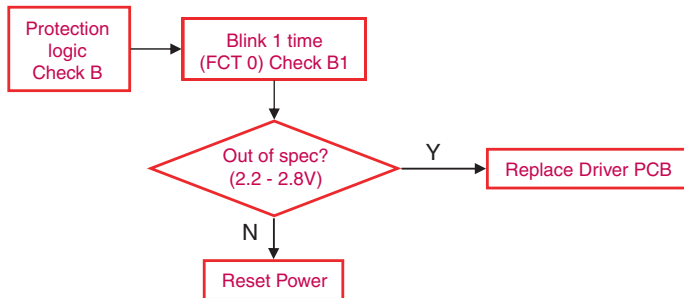

B2. LED blinks two times, then repeats (Stroke Trip: A & E Inverters)

Protection Logic



Blink Blink OFF Blink Blink OFF

- Purpose: Prevent abnormally long piston strokes.
- Case 1. If compressor doesn't work and LED blinks - Cause: Possibly harness from compressor to PCB might be defective.
- Case 2. If compressor works intermittently and LED blinks - Cause: Condenser Fan or Freezer Fan is not running. Sealed system problem such as moisture restriction, restriction at capillary tube or refrigerant leak.
- Logic: Compressor is forced to off and then tries to restart after 1 minute.

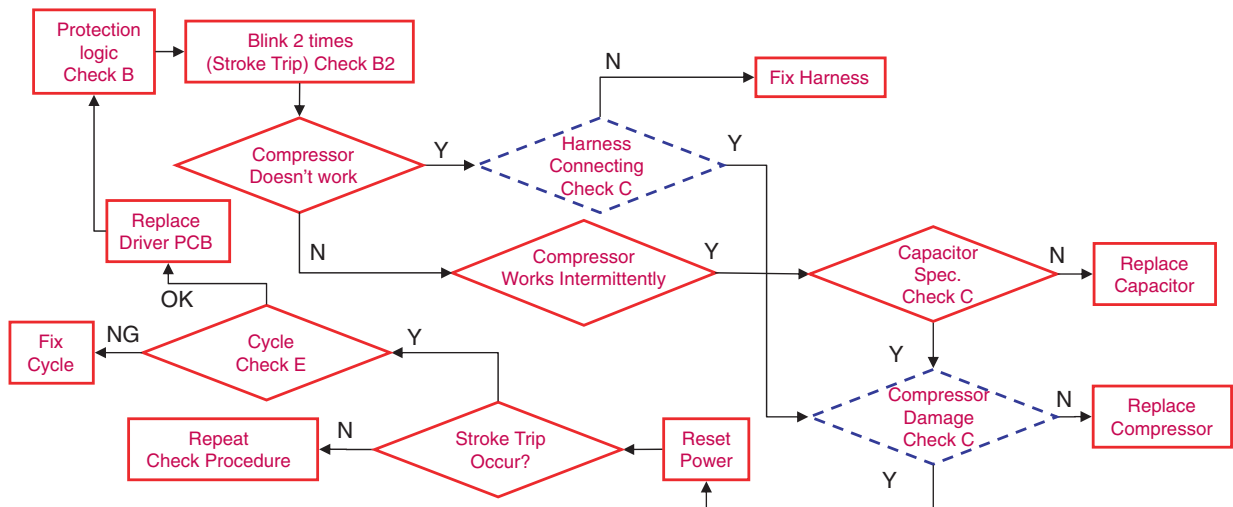

B3. LED blinks five times, then repeats (Locked Piston: A & E Inverters)

Protection Logic



Blink Blink Blink Blink Blink OFF

- Purpose: To detect locked piston
- Cause: Lack of oil to the cylinder, cylinder or piston damaged and or restricted discharge. A Locked Piston can also be caused by foreign materials inside the compressor.
- Logic: Compressor is forced off and tries to restart within 2.5 minutes.

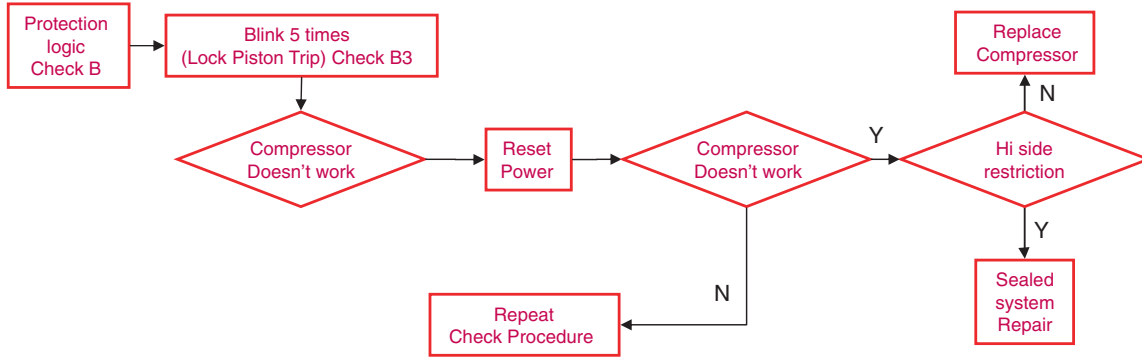

B4. LED blinks six times, then repeats (Current Trip: A & E-Inverters)

Protection Logic



Blink Blink Blink Blink Blink Blink OFF

- Purpose: Prevent over-current (overload protect)
- Cause: Ambient temperature is high (over 43°C) and/or refrigerator's condenser air movement is restricted.
- Condenser Fan is stopped, restricted discharge line, compressor is damaged, or IPM device is defective.
- Logic: Compressor is forced off and tries to restart after 2.5 minutes.

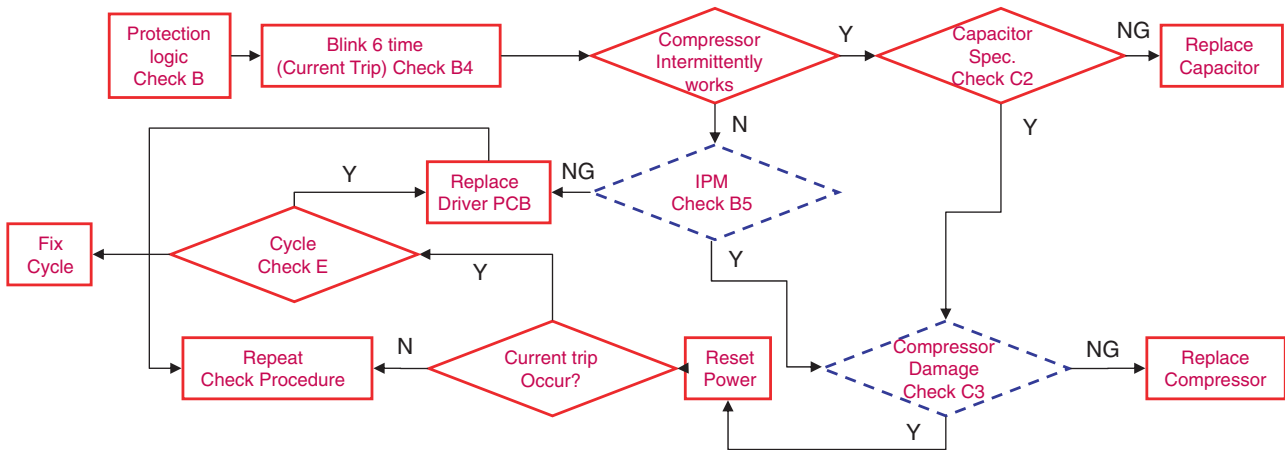

B5. LED blinks seven times, then repeats (IPM Fault: A & E Inverters)



Blink Blink Blink Blink Blink Blink OFF

- Purpose: Prevent high current due to IPM Short
- Cause: Damaged IPM (Dead Short)
- Test for a dead short at **Point A** with a VOM.
- Logic: Compressor is forced off and tries to restart in 2.5 minutes.

Protection Logic

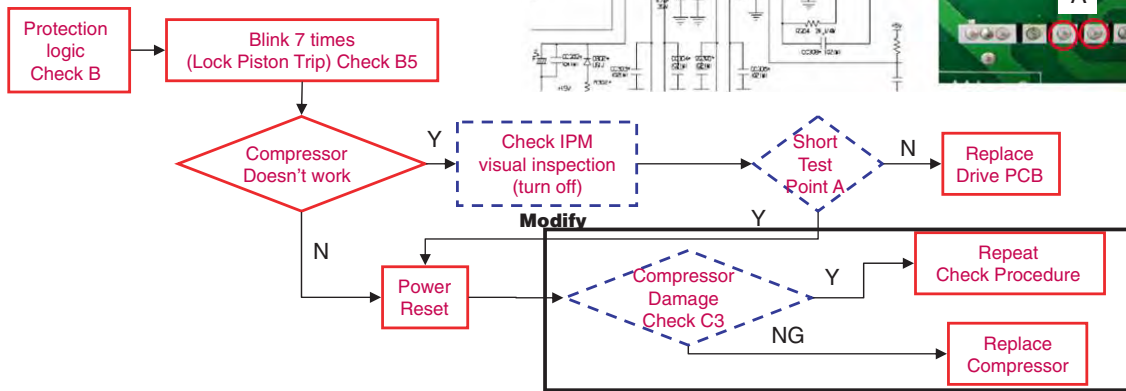
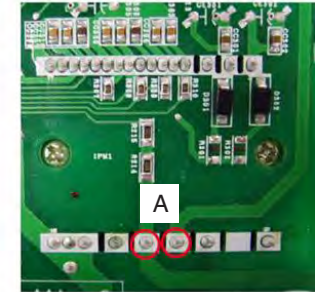
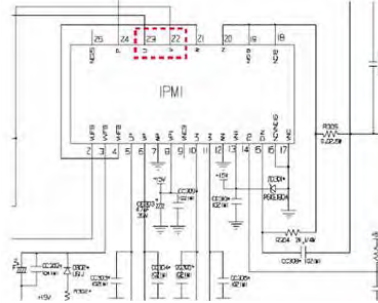

9-3 Check C

- C1. Harness Connection Check
- C2. Capacitor Specifications
- C3. Compressor Check

Check Process

- Step 1. Power off. Step 2. Check capacitor spec. (table1). Step3. Check resistance of point A
- Step 4. Check wire harness (INF ohm). Step 5. Check resistance at point B. Step 6. Point D.

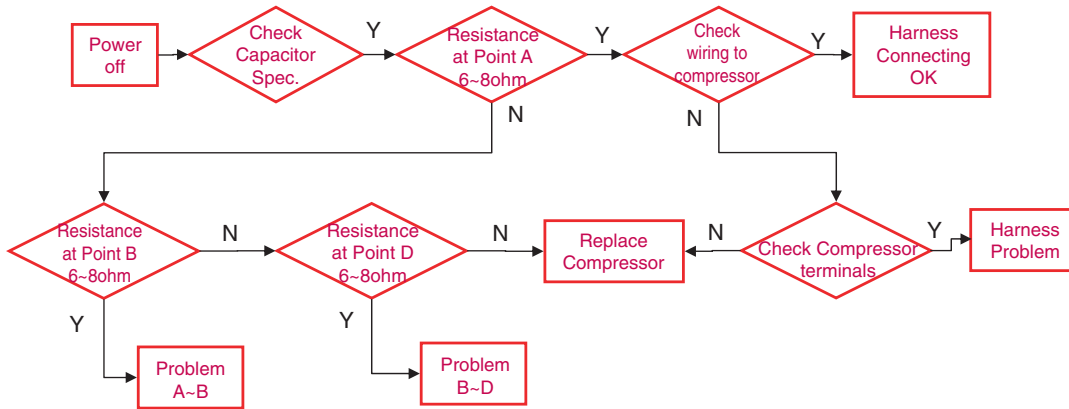

Caution : Turn off power during check C

- Measure the resistance at each point except point C
- Dead short check: measure the resistance between power line in compressor and earth ground in refrigerator (Inf. Ohm)

FC150NAMA

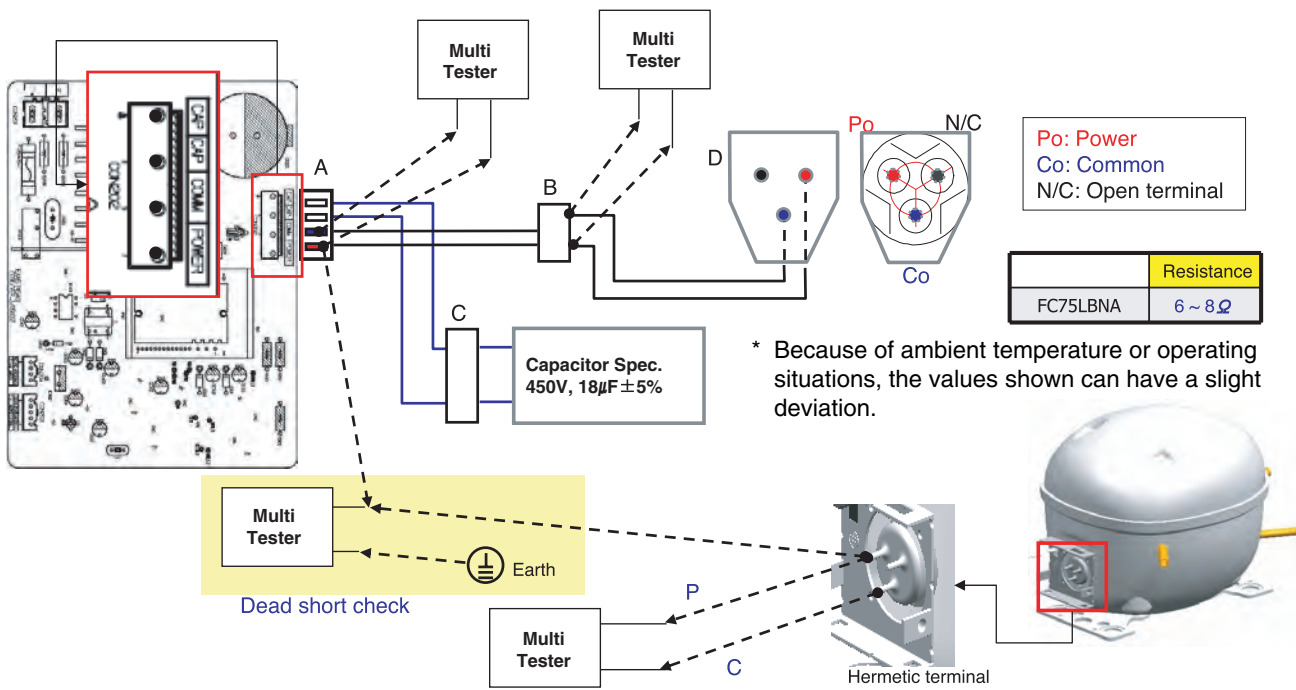

9-4 Check D

D1. Activate Protection logic

Cycle check with protection logic

- We have to check Condenser fan and Freezer fan before performing Check D
- Locked Piston, Current trip and stroke trip can be activated by other problems then the driver or compressor.

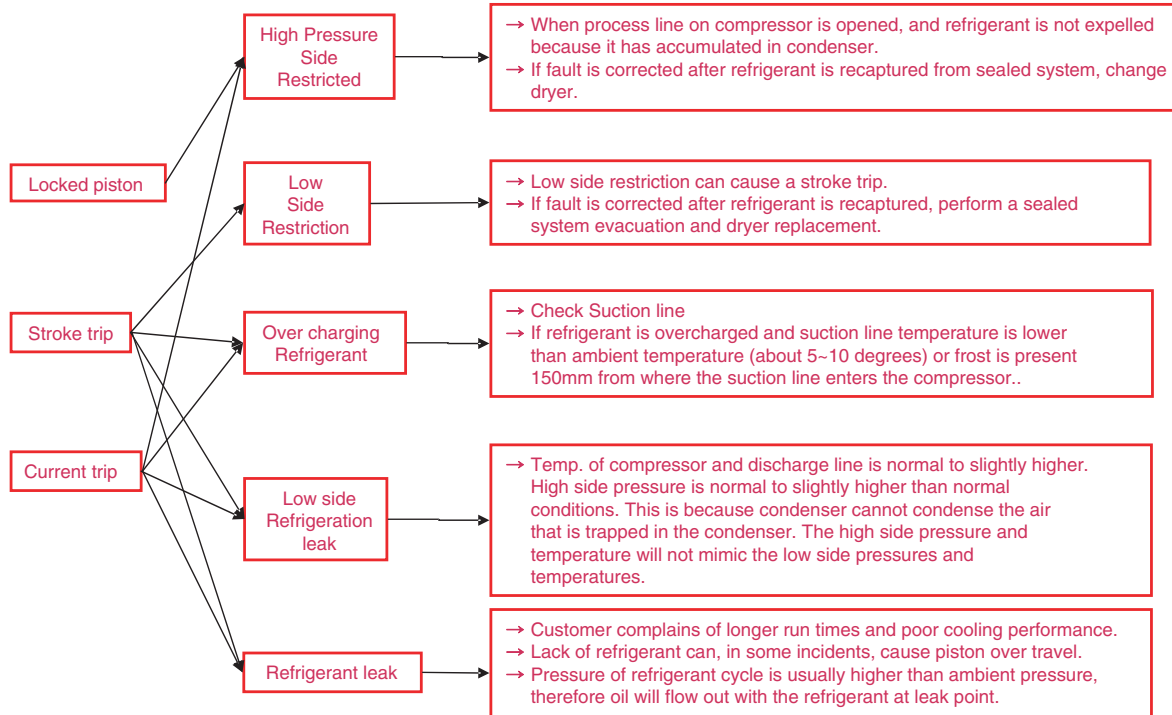

D2. sealed system diagnosis

- Check as follows;

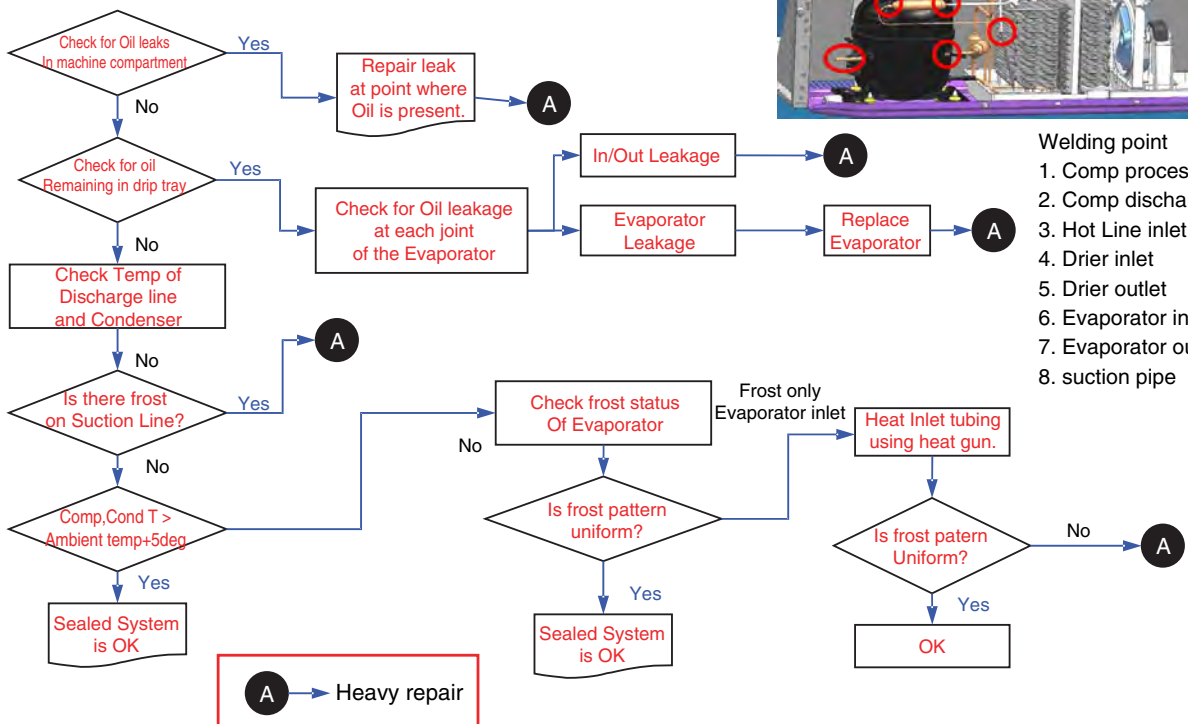

Compressor Troubleshooting





Step 1) Loosen up screw of Case Assembly PCB and open the Cover PCB

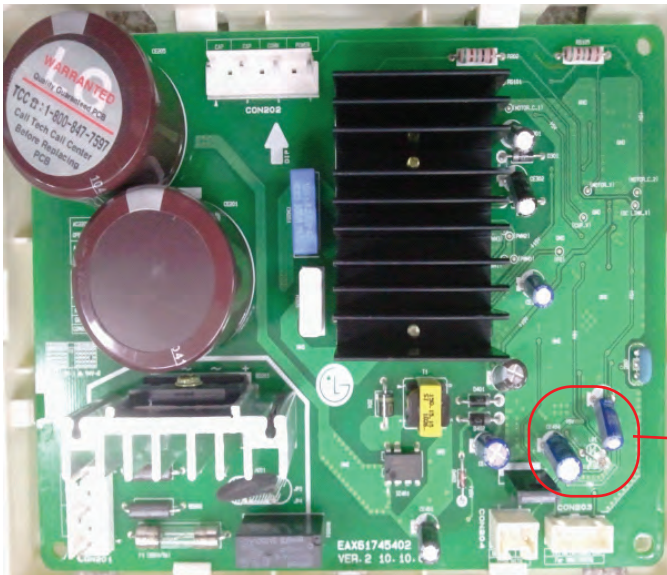

Step 2) Check for blinking frequency of LED, PWB



If compressor is normal, it does not blink
: Refer to the next page to find out what actions to take according to how many times LED blink

No	LED operating condition	Cause	Service guideline
1	<p>LED two - time repetiton (Stroke Trip)</p>  <p>..on - on - off - on - on - off - on - on - off ..repeating</p>	PCB Parts defect or Compress or Connector miss connecting (Piston over run)	<ol style="list-style-type: none"> 1. Please check, Whether connector of compressor is attached rightly or not. after power off 2. After the first action, You check on normal operation of compressor. 3. If the same symptom arises after the second action, replace PCB
2	<p>LED five - time repetiton (Piston Lock Trip)</p>  <p>..on - on - on - on - on - off - on - on - on - on - on - off ..repeating</p>	Piston constraint	<ol style="list-style-type: none"> 1. After resetting power, check if it is running normal 2. If the same symptom arises after the first action 3. If the same symptom arises after the second action, replace compressor
3	<p>LED six - time repetiton (Current Trip)</p>  <p>..on - on - on - on - on - on - off - on - on - on - on - on - off ..repeating</p>	Circuit over current error Or cycle error	<ol style="list-style-type: none"> 1. After resetting power, check if it is running normal 2. If the same symptom arises after the first action 3. If the same symptom arises after the second action, replace compressor
4	<p>LED seven- time repetiton (IPM Fault Trip)</p>  <p>..on - on - on - on - on - on - on - off - on - on - on - on - on - on - off ..repeating</p>	PCB parts defect (IPM)	<ol style="list-style-type: none"> 1. After resetting power, check if it is running normal 2. If the same symptom arises after the first action, replace PCB

9-5 SERVICE DIAGNOSIS CHART

COMPLAINT	POINTS TO BE CHECKED	REMEDY
No Cooling.	<ul style="list-style-type: none"> Is the power cord unplugged from the outlet? Check if the power switch is set to OFF. Check if the fuse of the power switch is shorted. Measure the voltage of the power outlet. 	<ul style="list-style-type: none"> Plug into the outlet. Set the switch to ON. Replace the fuse. If the voltage is low, correct the wiring.
Cools poorly.	<ul style="list-style-type: none"> Check if the unit is placed too close to the wall. Check if the unit is placed too close to the stove, gas cooker, or in direct sunlight. Is the ambient temperature too high or the room door closed? Check if food put in the refrigerator is hot. Did you open the door of the unit too often or check if the door is sealed properly? Check if the Control is set to Warm position. 	<ul style="list-style-type: none"> Place the unit about 4 inches (10 cm) from the wall. Place the unit away from these heat sources. Lower the ambient temperature. Put in foods after they have cooled down. Don't open the door too often and close it firmly. Set the control to Recommended position.
Food in the Refrigerator is frozen.	<ul style="list-style-type: none"> Is food placed in the cooling air outlet? Check if the control is set to colder position. Is the ambient temperature below 41°F(5°C)? 	<ul style="list-style-type: none"> Place foods in the high-temperature section. (front part) Set the control to Recommended position. Set the control to Warm position.
Condensation or ice forms inside the unit.	<ul style="list-style-type: none"> Is liquid food sealed? Check if food put in the refrigerator is hot. Did you open the door of the unit too often or check if the door is sealed properly? 	<ul style="list-style-type: none"> Seal liquid foods with wrap. Put in foods after they have cooled down. Don't open the door too often and close it firmly.
Condensation forms in the Exterior Case.	<ul style="list-style-type: none"> Check if the ambient temperature and humidity of the surrounding air are high. Is there a gap in the door gasket? 	<ul style="list-style-type: none"> Wipe moisture with a dry cloth. It will disappear in low temperature and humidity. Fill up the gap.
There is abnormal noise.	<ul style="list-style-type: none"> Is the unit positioned in a firm and even place? Are any unnecessary objects placed in the back side of the unit? Check if the Drip Tray is not firmly fixed. Check if the cover of the compressor enclosure in the lower front side is taken out. 	<ul style="list-style-type: none"> Adjust the Leveling Screw, and position the refrigerator in a firm place. Remove the objects. Fix the Drip Tray firmly in the original position. Place the cover in its original position.
Door does not close well.	<ul style="list-style-type: none"> Check if the door gasket is dirty with an item like juice. Is the refrigerator level? Is there too much food in the refrigerator? 	<ul style="list-style-type: none"> Clean the door gasket. Position in a firm place and level the Leveling Screw. Make sure food stored in shelves does not prevent the door from closing.
Ice and foods smell unpleasant.	<ul style="list-style-type: none"> Check if the inside of the unit is dirty. Are foods with a strong odor unwrapped? The unit smells of plastic. 	<ul style="list-style-type: none"> Clean the inside of the unit. Wrap foods that have a strong odor. New products smell of plastic, but this will go away after 1-2 weeks.

● Other possible problems:

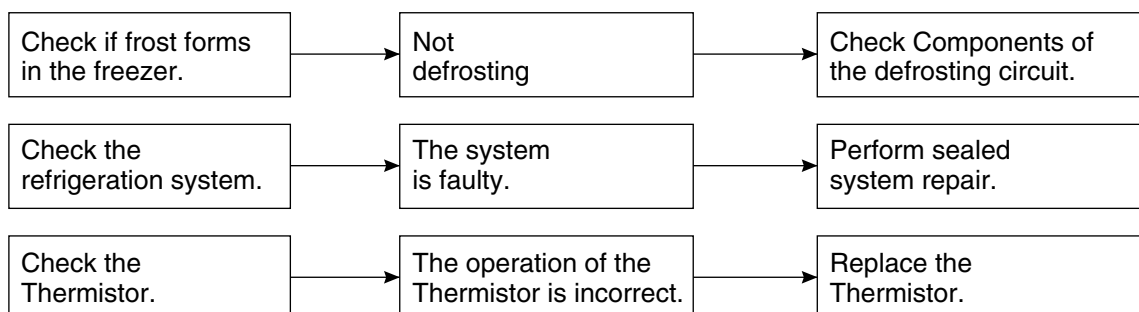

9-6 REFRIGERATION CYCLE

▼ Troubleshooting Chart

CAUSE		STATE OF THE UNIT	STATE OF THE EVAPORATOR	TEMPERATURE OF THE COMPRESSOR	REMARKS
LEAKAGE	PARTIAL LEAKAGE	Freezer compartment and Refrigerator don't cool normally.	Low flowing sound of Refrigerant is heard and frost forms in inlet only.	A little higher than ambient temperature.	<ul style="list-style-type: none"> Refrigerant level is low due to a leak. Normal cooling is possible by restoring the normal amount of refrigerant and repairing the leak.
	COMPLETE LEAKAGE	Freezer compartment and Refrigerator don't cool normally.	Flowing sound of refrigerant is not heard and frost isn't formed.	Equal to ambient temperature.	<ul style="list-style-type: none"> No discharging of Refrigerant. Normal cooling is possible by restoring the normal amount of refrigerant and repairing the leak.
CLOGGED BY DUST	PARTIAL CLOG	Freezer compartment and Refrigerator don't cool normally.	Flowing sound of refrigerant is heard and frost forms in inlet only.	A little higher than ambient temperature.	<ul style="list-style-type: none"> Normal discharging of the refrigerant. The capillary tube is faulty.
	WHOLE CLOG	Freezer compartment and Refrigerator don't cool.	Flowing sound of refrigerant is not heard and frost isn't formed.	Equal to ambient temperature.	<ul style="list-style-type: none"> Normal discharging of the Refrigerant.
MOISTURE CLOG		Cooling operation stops periodically.	Flowing sound of refrigerant is not heard and frost melts.	Lower than ambient temperature.	<ul style="list-style-type: none"> Cooling operation restarts when heating the inlet of the capillary tube.
DEFECTIVE COMPRESSION	COMP-RESSION	Freezer and Refrigerator don't cool.	Low flowing sound of refrigerant is heard and frost forms in inlet only.	A little higher than ambient temperature.	<ul style="list-style-type: none"> Low pressure at high side of compressor due to low refrigerant level.
	NO COMP-RESSION	No compressing operation.	Flowing sound of refrigerant is not heard and there is no frost.	Equal to ambient temperature.	<ul style="list-style-type: none"> No pressure in the high pressure part of the compressor.

12-6-1 Cleaning

There is no need for routine condenser cleaning in normal Home operating environments. If the environment is particularly greasy or dusty, or there is significant pet traffic in the home, the condenser should be cleaned every 2 to 3 months to ensure maximum efficiency.

If you need to clean the condenser:

- Remove the mechanical cover.
- Use a vacuum cleaner with a soft brush to clean the grille, the open areas behind the grille and the front surface area of the condenser.
- Replace the mechanical cover.

9-6-2 SEALED SYSTEM DIAGNOSIS

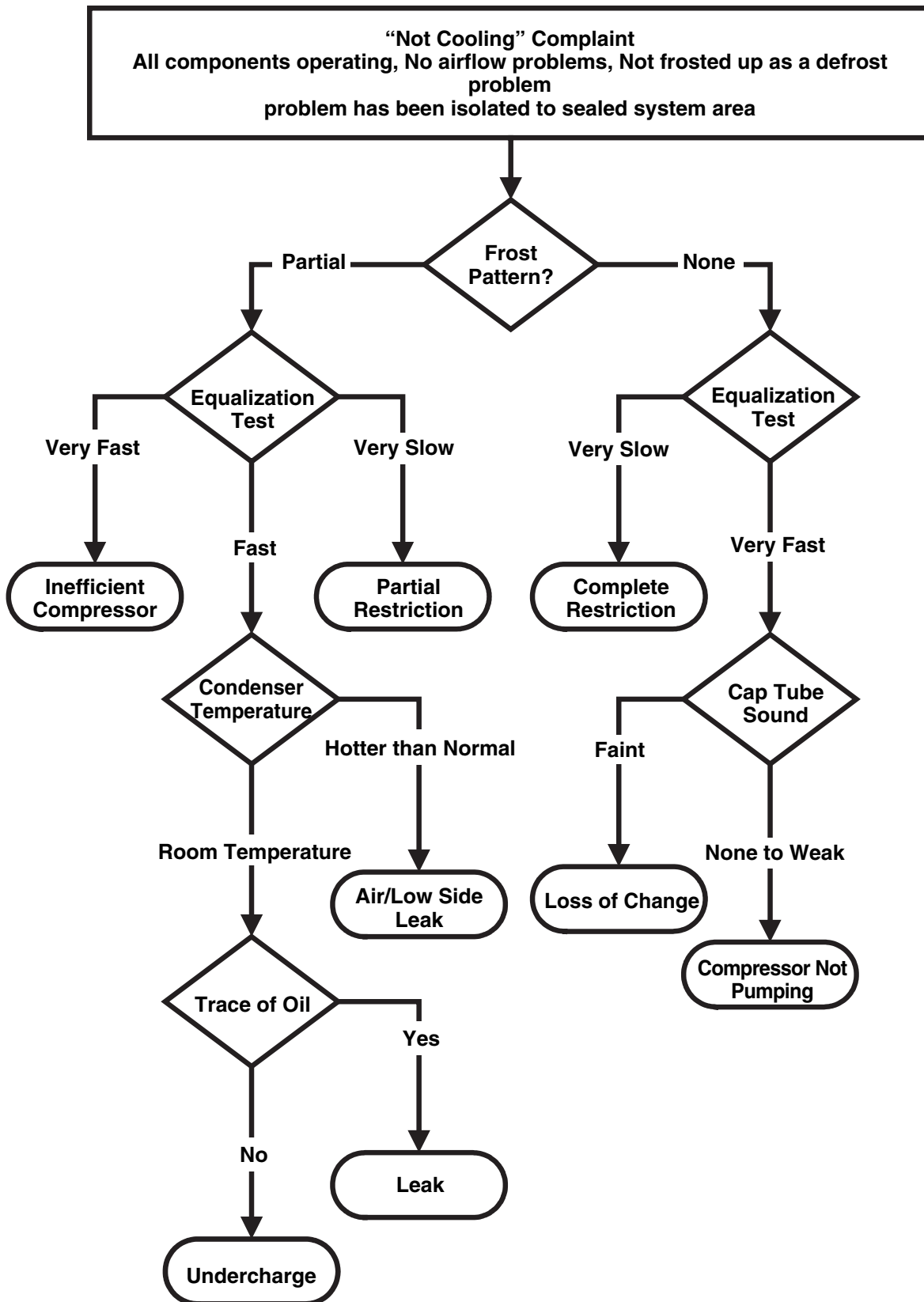

(The equalization test is trying to restart a compressor using a start kit after it has been operating.)

10. ICEMAKER OPERATING METHOD AND TROUBLE SHOOTING

10-1 Icemaker's Basic Operating Method

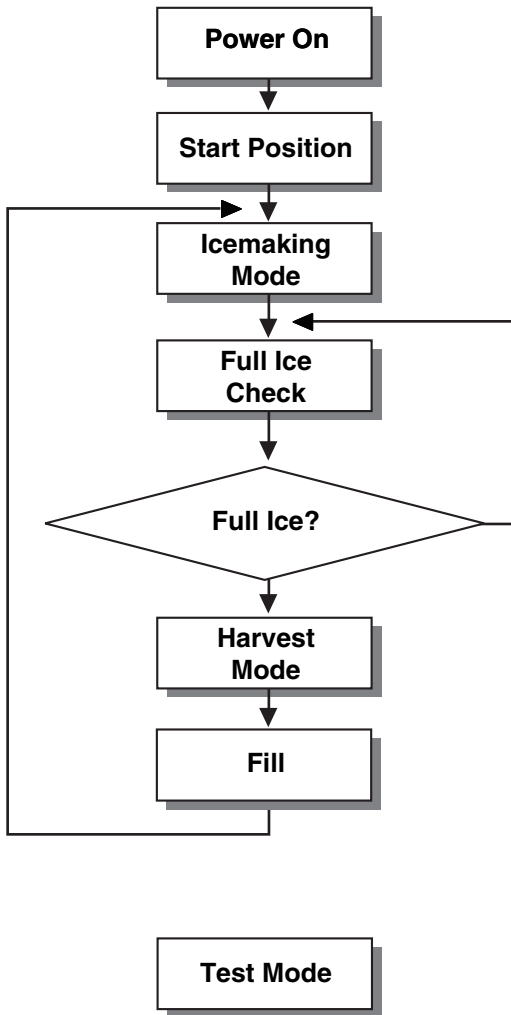

- Adjusts Ice Tray to Start Position with power on.



- Waits until water becomes ice.
 ※ For cold air circulation, Ice tray will be on a slightly tilt one hour after ice-making mode begins. A tilt ice tray means icemaker's normal operation.



- If water becomes ices in the ice tray, Ice-detecting sensor check if the ice bin is full.



- Twist the ice tray to drop ice into the ICE BIN.



- Supply water to the ice tray by operating the solenoid valve.



- To force water to supply to the ice tray, or check icemaker's condition press and hold the **FILL Key** for about 3seconds.
 In the test mode, The icemaker will run through 3 stages step by step
 : **Harvest** → **Fill water** → **Ice making**

To reset the icemaker's operation, set the power switch OFF position and back it to ON position.

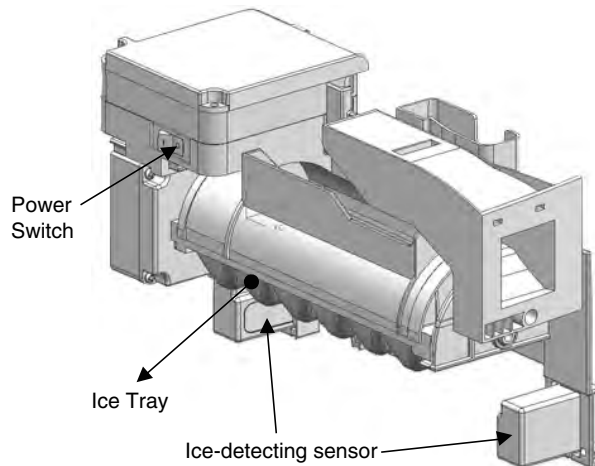

Icemaker Unit

10-2 ICE MAKER FUNCTIONS

10-2-1 Icemaking Mode

1. Icemaking Mode begins right after the ice tray fills with water.
 2. Icemaker waits until water becomes ice in the ice tray.
- ※ Ice-detecting sensor checks if the ice bin is full every 2min.

10-2-2 Harvest Mode

At least in 110min, since icemaker begun icemaking mode, Icemaker starts to twist the ice tray to drop ices into the Ice bin. (After installation, at least 1day is needed to make ices)

- ※ If the icemaker never drop ices to the ice bin though water becomes ices in the ice tray, check the real temperature of compartment. (not temperature on display)
Icemaker needs below 0°F to drop ices to ice bin.

13-2-3 Fill/Park Position

Once the normal harvest mode has been completed, the water solenoid will be activated.

10-3 Trouble Shooting Ice & Water system Issues

10-3-1 Icemaker not making ice or not making enough ice (Environmental Diagnosis)

- Icemaker can't make ices itself. Basically, water, temperature and time are needed.
- Water : If no Water, then no Ice.
 - Temperature : The compartment, where the icemaker is located, has to be at least 1°F so that icemaker dumps ices to the bin.
 - Time : At least 80 minutes must be passed to make one series of ices after water comes into icemaker.
- ※ **Test Mode should not be carried out before checking below.**

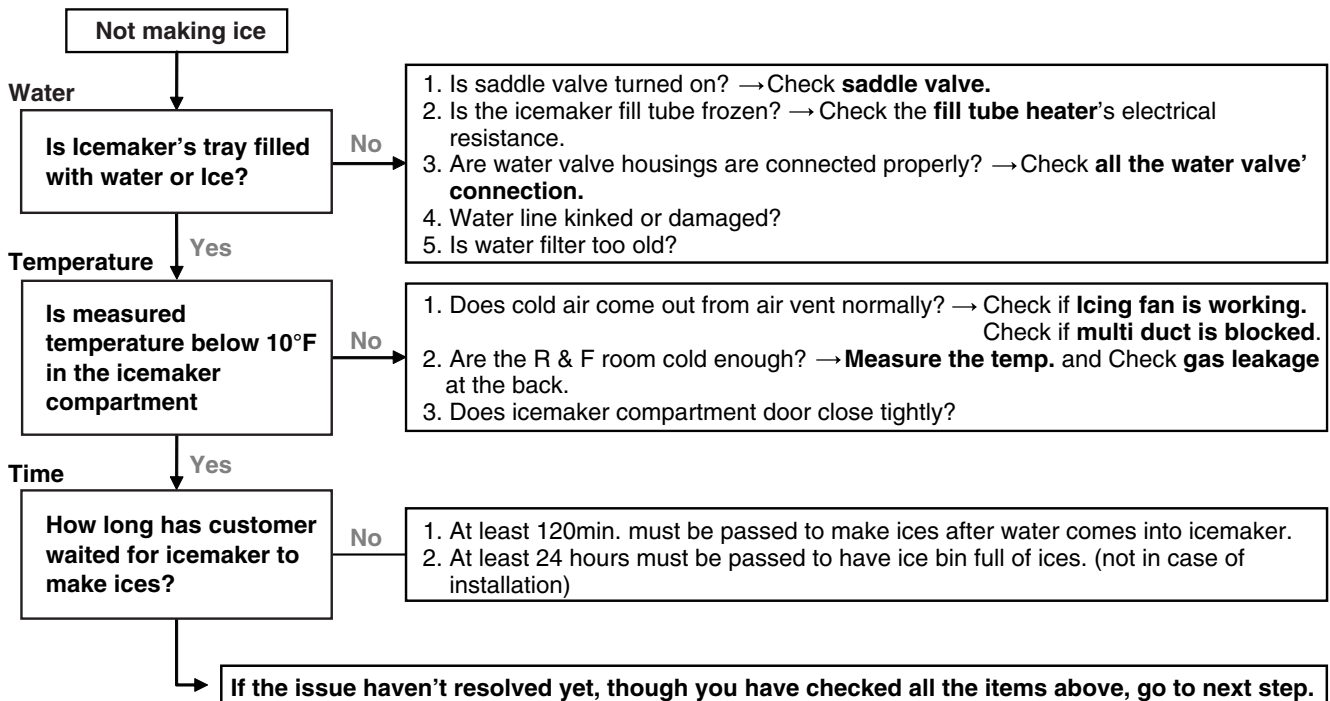

10-3-2 Icemaker not making ice or not making enough ice (Icemaker Unit & Ice-detecting sensor Diagnosis)

► Icemaker Unit and Ice-detecting sensor Diagnosis

The icemaker unit and Ice-detecting sensor is programmed to be diagnosed.

Follow the procedure step by step to check to see if icemaker and Ice-detecting sensor is working normally.

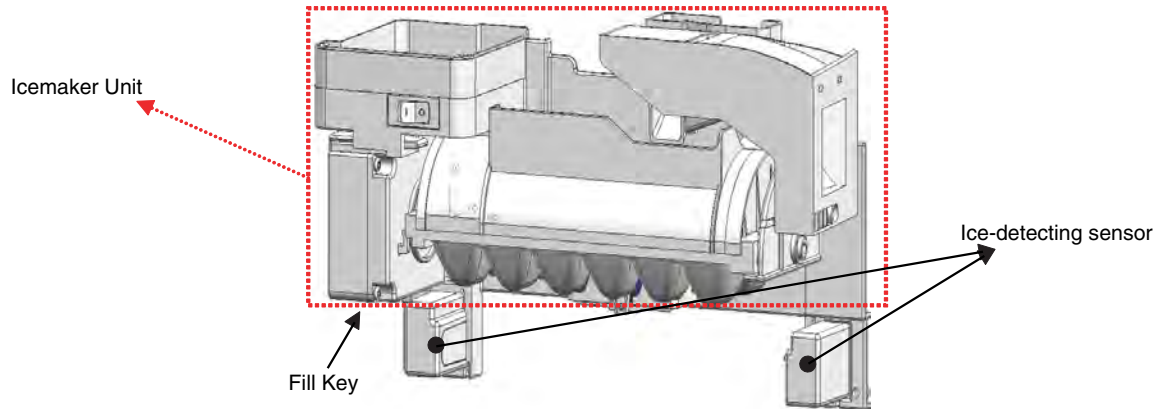

1st STEP (Icemaker Unit Diagnosis)

Press the fill key for about 3sec. If the icemaker runs 2 stages of harvest and filling water step by step, It means icemaker's mechanism is normal.



※ Caution : Be sure that the ice tray is not filled with water before pressing fill key.

2st STEP (Ice-detecting sensor Diagnosis)

1. Remove Ice bin from compartment



2. Close the left door (Door switch pushed)

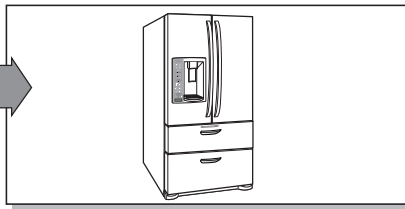

3. Wait for 3min.



4. Freezer door stays open

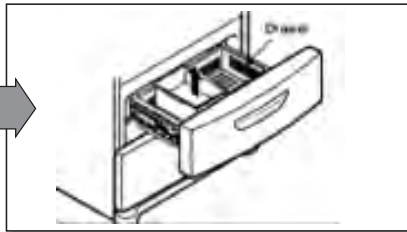

5. Push the refrigerator button & lock button at the same time.



If **"ETY"** is shown on the display after the procedure above, Ice-detecting sensor is **normal**.
If **"FULL"** is shown on the display after the procedure above, Ice-detecting sensor is **abnormal**.
※ ETY = empty

10-3-3 Icemaker not making ice or not making enough ice (Other Suspected Items)

Strongly suspect items below If the issue remains yet, though all the diagnosis for icemaker has been carried out.

- Cap duct bad sealing
- Defective thermal sensor in the icemaker compartment
- Not cold icemaker compartment area (sealed system)

10-3-4 Not Dispensing Ice

► Clogged Ice In the Ice Bin (suspected items)

- Customer haven't used ice dispenser over a week.
→ **Resolution** : the ices gets stuck if customer doesn't use ice dispenser.
In this case, empty the ice bin and wait until the new ices are stacked in the ice bin.
- Temperature of icemaker compartment is not cold enough.
→ **Resolution** : Check ice fan, sealed system, cap duct, vent and other items related to temperature.
- Cap duct doesn't seal the air properly.
→ **Resolution** : Possibly, warm air could get into the compartment and make ices get stuck. Replace the cap duct with new one.
- In-door geared motor doesn't work
→ **Resolution** : Change the in-door geared motor and test it.
- The water comes out of fill cup and the water get into the ice bin.
→ **Resolution** : The water pressure from shutoff valve is too high.
Recommend to use regulator to the customer and close the shutoff valve slightly.

► Clogged Ices In the Chute (suspected items)

- Cap duct doesn't seal the air properly.
→ **Resolution** : Possibly, warm air could get into the compartment and make ices get stuck. Replace the cap duct with new one.

11. DESCRIPTION OF FUNCTION & CIRCUIT OF MICOM

11-1 FUNCTION

11-1-1 Function

1. When the appliance is plugged in, it is set to 37°F for Refrigerator and 0°F for freezer.
You can adjust the Refrigerator and the Freezer control temperature by pressing the ADJUST button.
2. When the power is initially applied or restored after a power failure, it is set to Control temperature Previously.
3. If you do not press any button after turning on the power, only CRUSH or CUBE Label that has been selected will be turned on and all other LEDs on the display Panel will be turned off Within 60 seconds.
4. If you press a button, only CRUSH or CUBE Label that has been selected will be turned on and all other LEDs on the display Panel will be turned off Within 20 seconds.

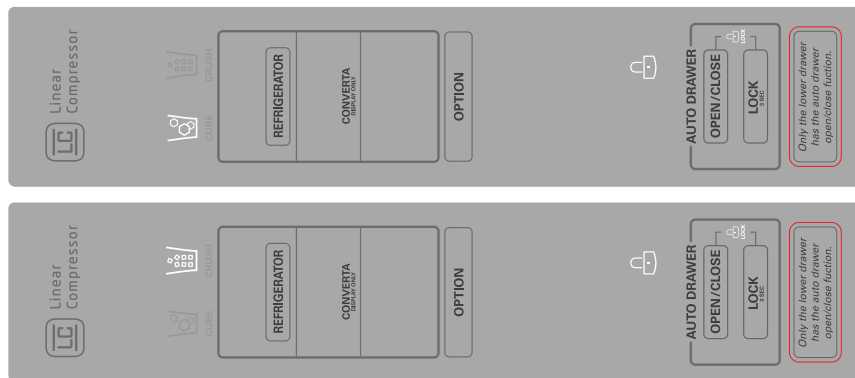

5. If you do not want to use the Power Save Mode, you can change the Mode by pressing the ICE PLUS Button and Freezer TEMP button simultaneously for more than 5 seconds.

11-1-2 How to Toggle the Display between °F & °C

1. The initial setting is °F and the display temperature mode can be changed from °F to °C or °C to °F by pressing and holding the FRZ TEMP and the REF TEMP keys at the same time for over 5 seconds.

11-1-3 Metered fill function

SETTING THE METERED FILL UNIT

You can change the unit of Metered fill.



As you can see the left, the initial unit after power on is OZ.

The unit is changed to CUPS when you press and hold this button at least 3 seconds and when you press it again, changed to OZ.

While water is dispensed, the numbers will be increase.

11-1-4 Dispenser use selection

SETTING THE DISPENSER

You can select the ice type of the dispenser.



The default setting is CRUSHED ice.

Press CUBE to get cubes instead of crushed ice.

11-1-5 Light function

SETTING THE LIGHT

You can control the lamp in the dispenser.



The lamp is off when the power on.
When you press the LIGHT button, the lamp turns on, the icon also on.
When you press it again, the lamp turns off, and the icon also turns off.

11-1-6 Filter condition display function

SETTING THE FILTER RESET

You need to reset filter remaining period after replacing filter.



Press and hold the FILTER RESET button more than 3 seconds to reset the filter indicator after the water filter has been replaced.
The figure is changed 6 → 0 after pressing it more than 3 seconds.

NOTE: It is recommended that the filter be replaced when the indicator light on the front dispenser reaches 0.

11-1-7 Ice Plus selection

ACTIVATING ICE PLUS



Press the ICE PLUS button to activate the ICE PLUS function. The ICE PLUS function runs the freezer compartment at the coldest setting for 24-hour to increase ice making and then turns off automatically.
To deactivate this function, press it again.

11-1-8 Energy saving function

ACTIVATING ENERGY SAVING



Press the ENERGY SAVING button for at least 3 seconds to activate or deactivate the function.
This function is recommended for added energy savings. (Some heaters to reduce excess moisture on the refrigerator may be turned off)
The energy saving function is also recommended during long periods of time spent away from home-like vacation.

11-1-9 Alarm function

SETTING THE DOOR ALARM



The ALARM button also controls the door alarm that sounds three times in 30-second intervals when a compartment door is left open for more than 60 seconds. The alarm stops sounding when the door is closed.
Press the ALARM button once to activate and deactivate the door alarm function.

NOTE: Contact authorized service center if the alarm continues to sound after the doors are closed.

11-1-10 Auto drawer lock function

SETTING AUTO DRAWER LOCK

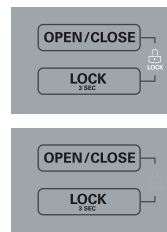

Press and hold the LOCK button more than 3 seconds to activate or deactivate the auto drawer lock function.
The auto drawer function is disabled when you locked the auto drawer.

11-1-11 Lock function(dispenser and display button lock)

SETTING THE DISPENSER LOCK



Press and hold the LOCK button for three seconds to lock the dispenser and all of the other control panel functions. Press and hold again for 3 seconds to unlock.

11-1-12 CONTROL OF FREEZER FAN MOTOR

1. Freezer fan motor has high and standard speeds.
2. High speed is used at power-up, for Ultra Ice, and when refrigerator is overloaded.
Standard speeds is used for general purposes.
3. To improve cooling speed, the RPM of the freezer fan motor change from normal speed to high.
4. High speed (2700RPM) : Initial power on or load corresponding operation, Ultra Ice.
Normal speed (2400RPM) : General working conditions.

11-1-13 Cooling Fan Motor

1. The cooling fan is switched ON and OFF in conjunction with the compressor.
2. The cooling fan Motor has high and standard speeds. (When room temperature more high than 38°C speed is high)
3. The Failure sensing method is the same as in the fan motor of the freezing fan motor(refer to failure diagnosis function table for failure display).

11-1-14 Ice Compartment Fan

1. The Icing Fan is controlled by the the sensor on the top of the ice compartment.
2. The Failure sensing method is the same as in the fan motor of the freezer (refer to failure diagnosis function table for failure display)

11-1-15 Refrigeration room Fan Motor

1. The refrigeration room fan is switched ON and OFF in conjunction with the refrigeration room temperature.
2. The Failure sensing method is the same as in the fan motor of the freezing fan motor (refer to failure diagnosis function table for failure display).

11-1-16 Ice PLUS

1. The purpose of this function is to intensify the cooling speed of freezer and to increase the amount of ice.
2. Whenever selection switch is pressed, selection/release, the Icon will turn ON or OFF.
3. If there is a power outage and the refrigerator is powered on again, Ice PLUS will be canceled.
4. To activate this function, press the Ice PLUS key and the Icon will turn ON. This function will remain activated for 24 hrs. The first one hour the compressor, Freezer Fan and Icing Fan will be ON. The next 23.5 hours the Ice room will be controlled at the lowest temperature. After 24 hours or if the Ice PLUS key is pressed again, the Ice room will return to its previous temperature.
5. During the first hour :
 - (1) Compressor, Freezer Fan and Icing Fan run continuously.
 - (2) If a defrost cycle begins during the first 15 minutes of Ice Plus, the Ice PLUS cycle will complete its cycle after defrosting has ended.
If the defrost cycle begins when Ice Plus has run for more than 15 minutes, Ice PLUS will run for 20 minutes after the defrost is completed.
 - (3) If Ice PLUS is pressed during defrost, Ice Plus Icon is on but this function will start seven minutes after defrost is completed and it shall operate for 30min.
 - (4) If Ice Plus is selected within seven minutes after compressor has stopped, the compressor (compressor delays seven minutes) shall start after the balance of the delay time.
6. For the rest of the 23 hours, the Ice room will be controlled at the lowest temperature.

11-1-17 How to set the display mode and cancel it

1. With the refrigerator door open, keep pressing the Refrigerator Temp Button and ICE PLUS Button more than 5 seconds, then it goes to the display mode with Special Beep Sound With Special Beep Sound.
2. Perform the same way again to cancel the display mode.
3. All Freezing unit will be turned off at display mode (Exceptions : Lamp, Display)

11-1-13 Defrosting (removing frost)

1. Defrosting starts each time the COMPRESSOR running time Between 7~50 hours.
2. For initial power on or for restoring power, defrosting starts when the compressor running time reaches 4 hours.
3. Defrosting stops if the sensor temperature reaches 46.4°F(8°C) or more. If the sensor doesn't reach 46.4°F(8°C) in 1 hours, the defrost mode is malfunctioning. (Refer to the defect diagnosis function, 8-1-15.)
4. Defrosting won't function if its sensor is defective (wires are cut or short circuited)

11-1-14 Defect Diagnosis Function

1. Automatic diagnosis makes servicing the refrigerator easy.
2. When a defect occurs, the buttons will not operate; but the tones. such as ding. will sound.
3. When the defect CODE removes the sign, it returns to normal operation (RESET).
4. The defect CODE shows on the Refrigerator and Freezer Display.



- * Display check function: If simultaneously pressing Ultra Ice button and freezing temperature adjustment button for a second, display LCD graphics on. If releasing the button, the LCD graphic displays the previous status.
You can check the error code Within 3-hour Period from initial error

FREEZER PARTS

CAUTION: Use the part number to order part, not the position number.

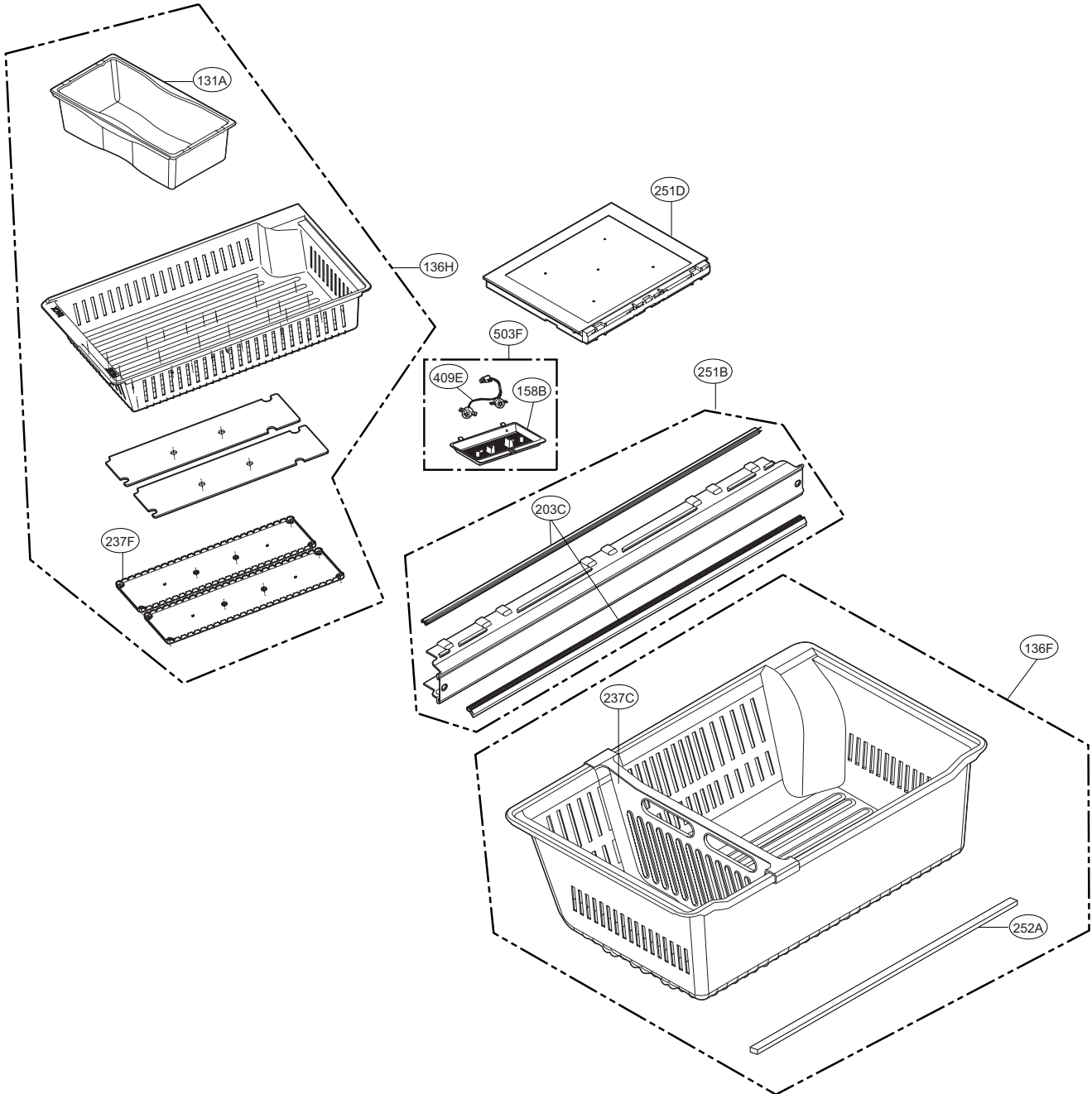

REFRIGERATOR PARTS

CAUTION: Use the part number to order part, not the position number.

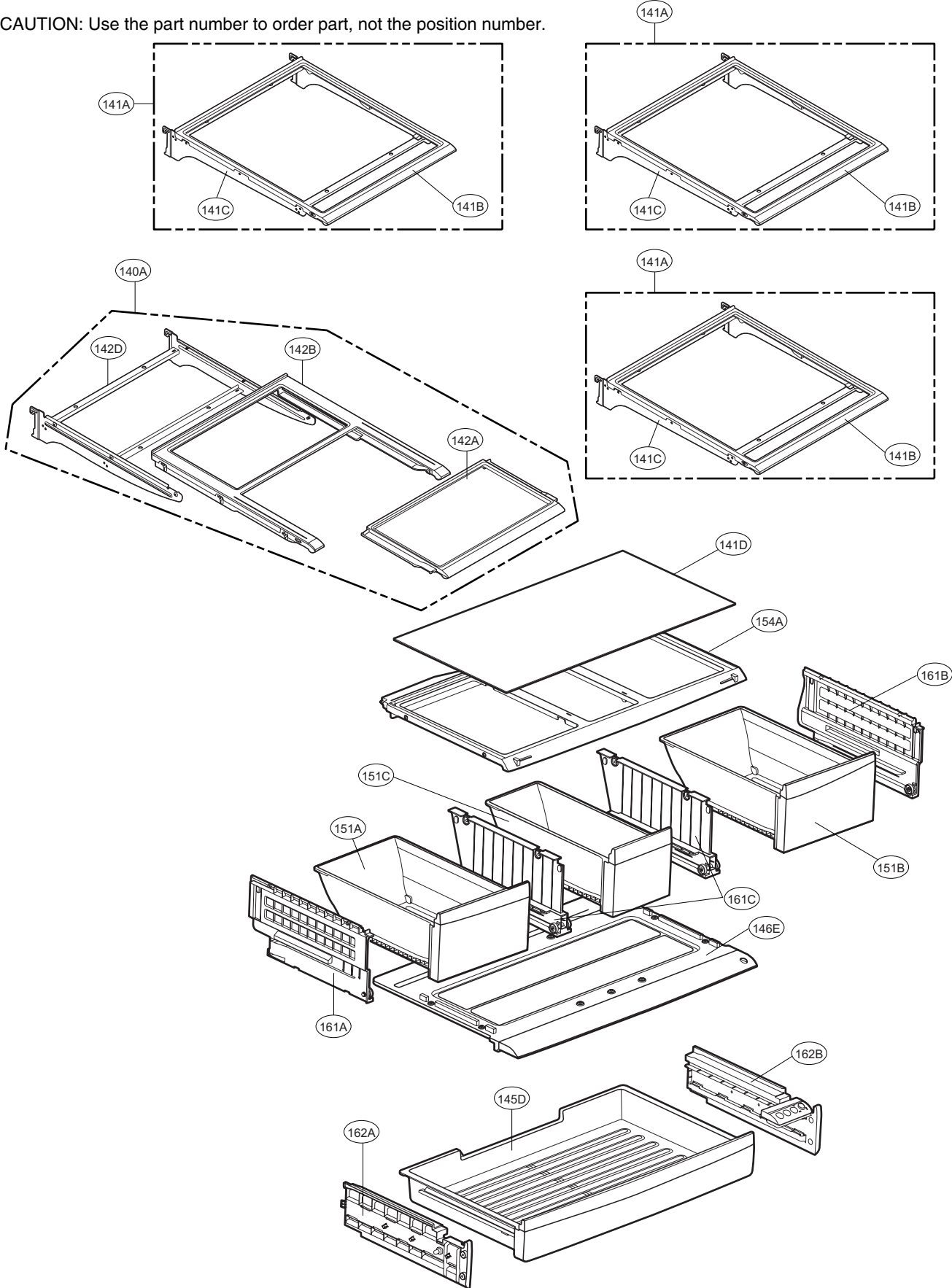

DOOR PARTS (LMX28994**)

CAUTION: Use the part number to order part, not the position number.

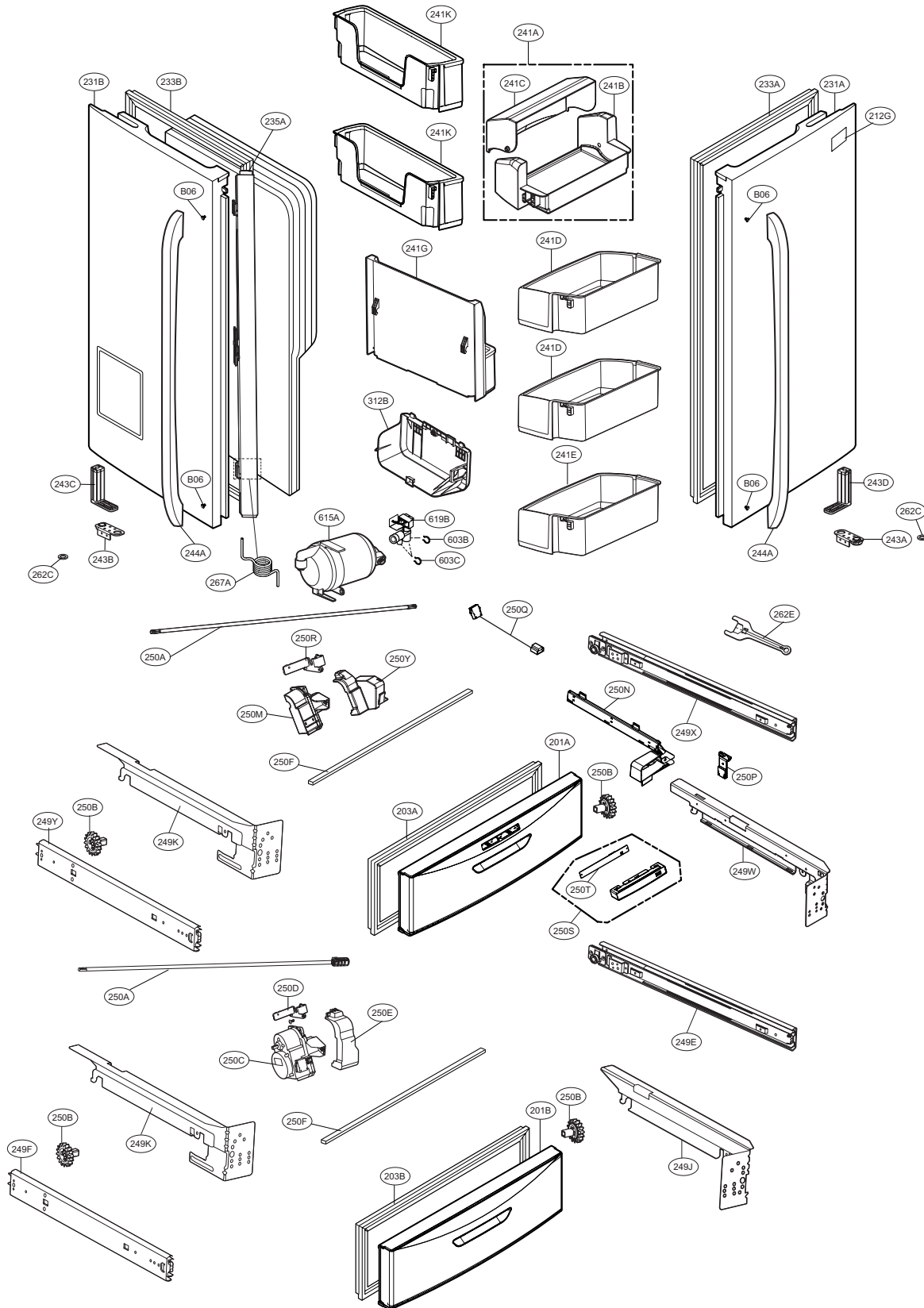

DISPENSER PARTS

CAUTION: Use the part number to order part, not the position number.

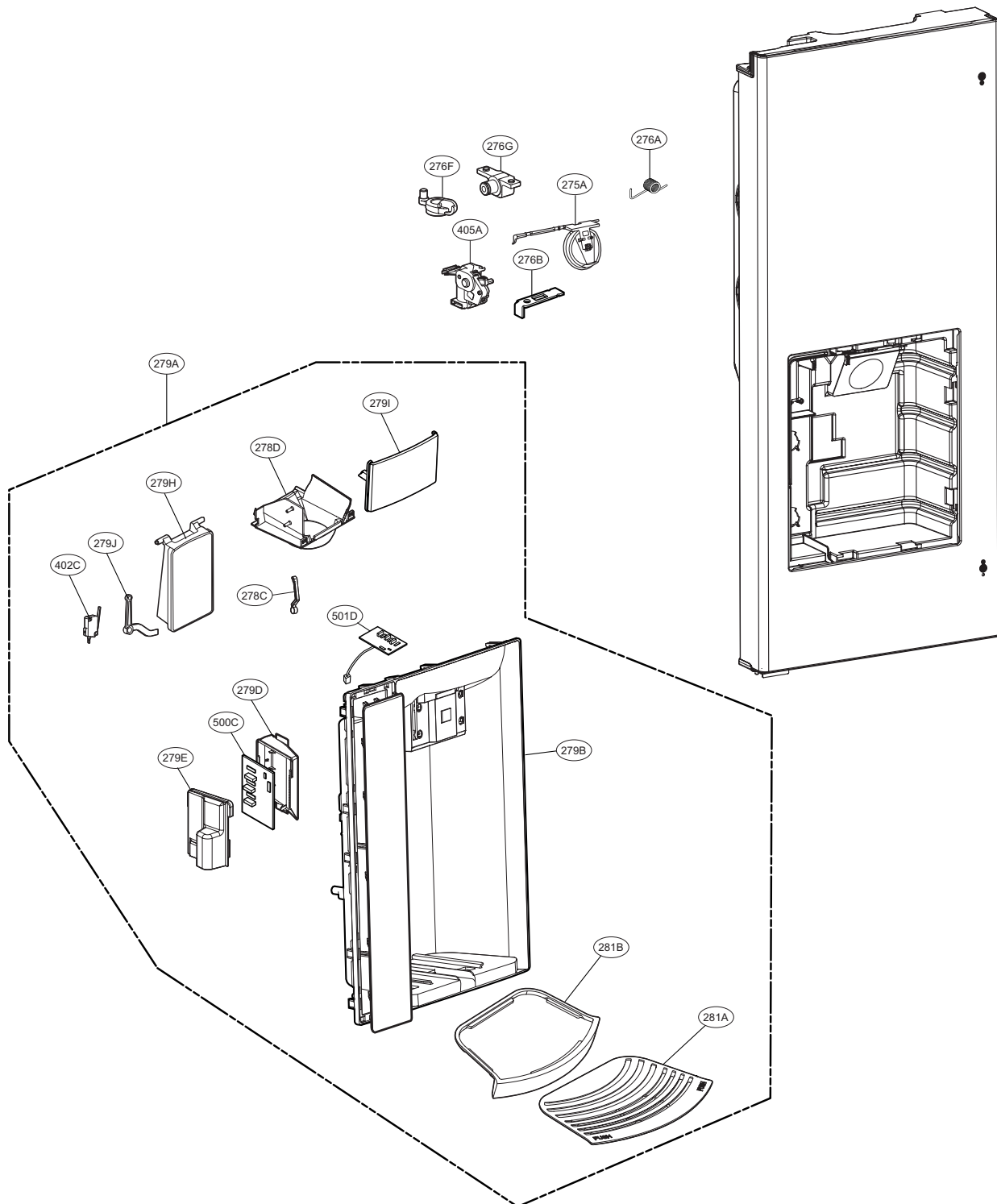

VALVE & WATER TUBE PARTS

CAUTION: Use the part number to order part, not the position number.

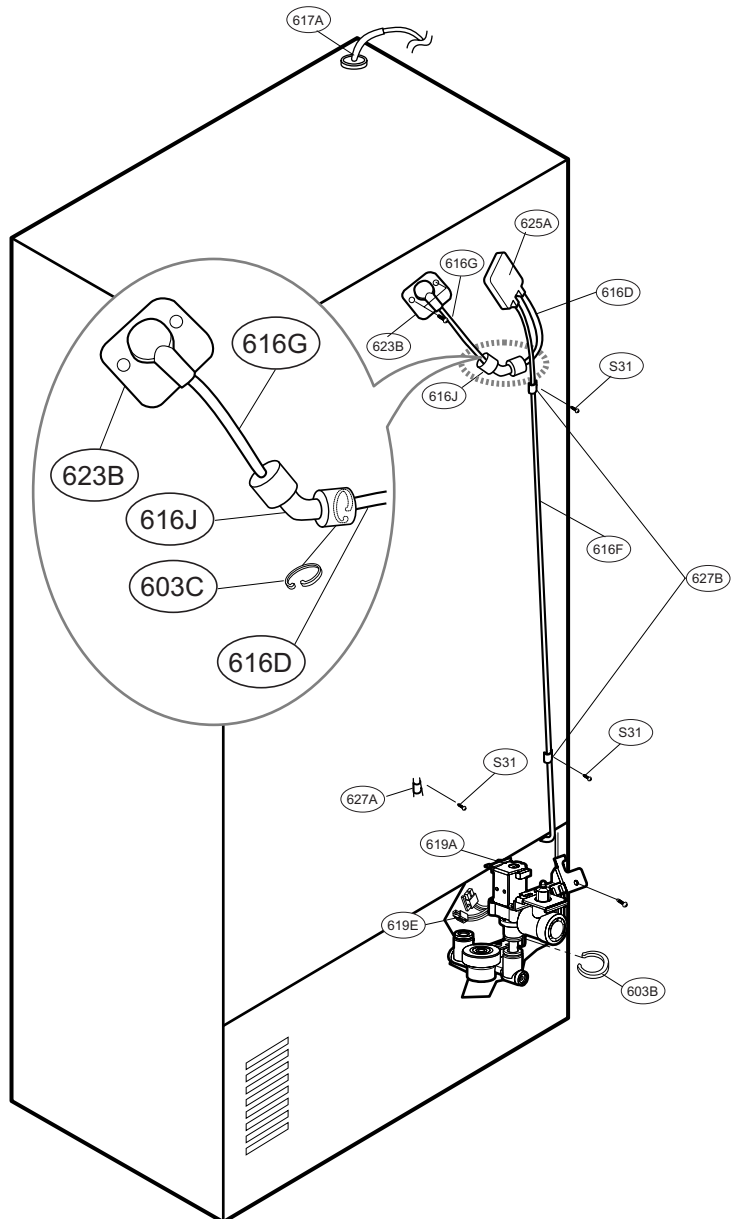
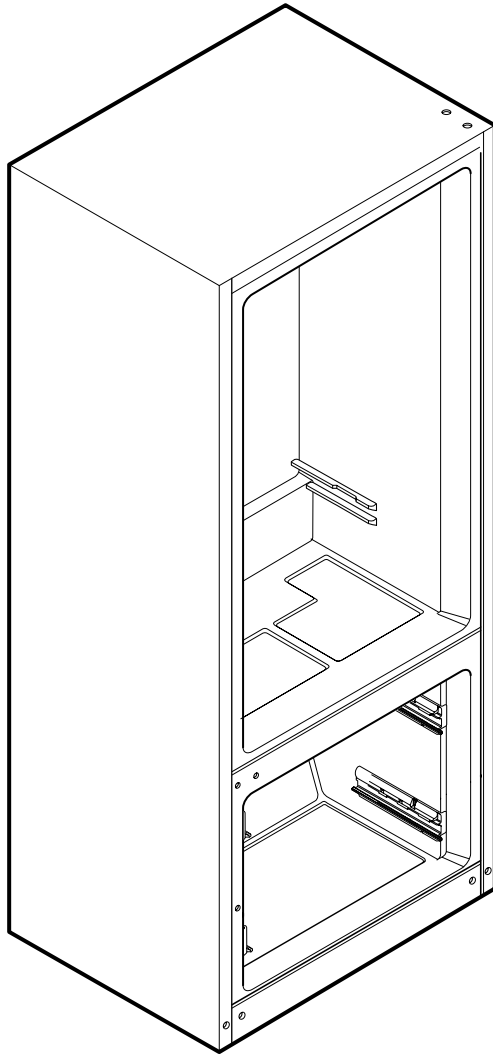

ICE MAKER & ICE BIN PARTS

CAUTION: Use the part number to order part, not the position number.

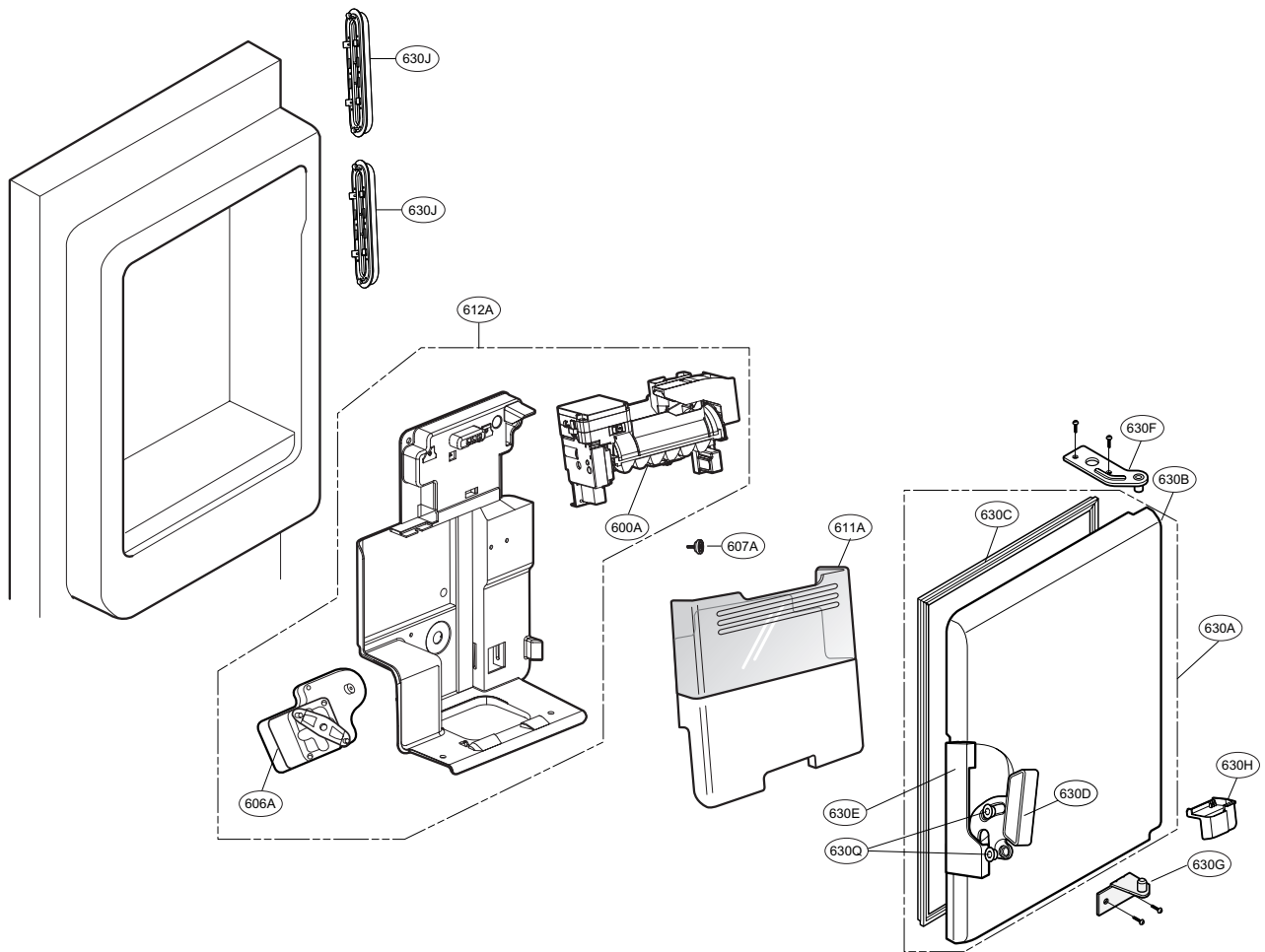



P/No. MFL62188114

SEP., 2010 Printed in Korea