

Haier SERVICE MANUAL

Order No. FL0909S001V1.1

Front Load Clothes Washer & Dryer Combo

MODEL: HWD1600

WARNING

This service information is designed for experienced repair technicians only and is not designed for use by the general public. It does not contain warnings or cautions to advise non-technical individuals of potential dangers in attempting to service a product. Products powered by electricity should be serviced or repaired only by experienced professional technicians. Any attempt to service or repair the product or products dealt with in this service information by anyone else could result in serious injury or death.

©2011 **Haier** Washing Machine
All rights reserved. Unauthorized copying and distribution is a violation of law.

Contents

Chapter 1	General Information	4
1-1.	General Guidelines	4
1-2.	Caution and Warning symbols	4
1-3.	Function indication symbols	4
Chapter 2	Product Feature	5
2-1.	Features	5
2-2.	Specification	6
Chapter 3	Matters needing attention	7
3-1.	Safety	7
3-2.	During Use	8
Chapter 4	Operational Guidance	1 0
Chapter 5	Program Introduction	1 3
Chapter 6	Appearance brief introduction	1 4
6-1.	Name of parts	1 4
6-2.	Net dimension	1 5
Chapter 7	Disassembly and Installation	1 5
7-1.	Remove packing materials	1 5

7-2. Dismantle packing bolts _____	1 6
7-3. Adjusting the washing machine _____	1 6
7-4. Joining the Inlet Hose to the Washing Machine _____	1 7
7-5. Connecting to the Power Supply _____	1 7
<i>Chapter 8 Wiring circuit _____</i>	<i>1 8</i>
8-1. Wiring circuit _____	1 8
8-2. Self check _____	1 9
<i>Chapter 9 Error Display and troubleshooting _____</i>	<i>2 0</i>
9-1. Error Display _____	2 0

Chapter 1 General Information

1-1. General Guidelines

When servicing, observe the original lead dress. If a short circuit is found, replace all parts which are overheated or damaged by the short circuit. After servicing, see to it that all the protective devices such as insulation barriers, insulation papers, shields are properly installed. Confirm that the screws, parts and wiring which were removed in order to service are put in the original positions, or whether there are the portions which are deteriorated around the service places serviced or not. And be sure safety of that.

1-2. Caution and Warning symbols

(You will see them in "Matters needing attention")



Any instructions in this service manual with this "Warning" sign must be followed strictly.



To prevent damage to the washing machine, any instructions in this manual with this "Stop" sign must be followed strictly.

1-3. Function indication symbols

(You will see them in the specification table)



Signify the washing machine has this function.



Signify the washing machine doesn't have this function.

Chapter 2 Product Feature

2-1. Features

Environmental friendly to protect your skin.

3-phases induction driver to save more energy and water

High speed is available for easily drying and washed items are always ready for further use.

Sterilization of electrolyzed water makes washing complete and clean

Super large LCD displayer provides a clear indication of functional operation

Memory function of power failure

Thorough rinse function

Dynamic washing function

Three drying programs can be selected

Super big laundries can be dried by the unit.

2-2. Specification

HWD1600			
MODEL		EXTERIOR FEATURES	
		Water Inlet	Hot/Cold
		Adjusting Legs	4
CAPACITIES		Castors	No
Size (lbs)	13.2	Appearance	New Control Panel
Wash Tub Capacity Cu. Ft.	1.8	Colors Available	White
FEATURES		Brand logo	Haier
Motor Speeds	1000	Top Surface	Yes
Wash Tub Material	Stainless Steel	PERFORMANCE DATA	
Fabric Care Cycles		Times of Rinse Cycle cot/syn	2/2
	Cotton	Wash Time each cycle cot/syn	90/58
	Synthetic	Total spin time cot/syn	9/9
	Wool	Dryer Element (Watts)	1300
	Silk	Dry Time(min)	120/60/30
	Quick	Total Wash & Dry Time(min)	210/178
	Sport	Volt-Hz	120~60
	Rinse	Kwh/yr	94.18
	Spin	Working Current (amps)	12
	Auto Dry	Energy Star Qualified	Yes
	60 Min Dry	Maximum Drying Time	0-120 Minutes
	Touch Up	Listing Agency	ETL
	power-off	TECHNICAL DATA	
Controls	LCD	Motor Size (hp)	0.60
Water Temp. Set (Wash & Rinse)	by button	Tube Spinning Speeds (RPM)	1000
Water Level Selections	Auto	Electrical Requirement	120v/60Hz
Quiet Sound Package	Ultra-Quiet	Heating Element	No
Wash Sensor	No	INSTALLATIONS	
Rinse Only Option	Yes	Stackable	No
Water Saver Option in Rinse Cycle	No	Stacking Kit	N/A
Detergent Dispenser	Yes	Built In / Free Standing	Yes
Fabric Softener Dispenser	Yes	DRYER FEATURES	
Bleach Dispenser	Yes	Wash or Dry Only Option	Yes
Self Cleaning Lint Filter	No	Dryer Heat Options	3
Button / Coin Trap	Yes	Dryer Ventilation	Condensing
Spin Cycle Only Option	Yes	DIMENSIONS (INCHES)	
Cycle End Signal	Yes	Width	23-7/16"
Child Lock	Yes	Depth With Door Open	41-3/4"
Self Locking Door	Yes	Depth With Door Closed	23-5/8"
Auto Balancing	Yes	Height	33-7/16"
Self Cleaning Pump	No	Unit Weight lbs. (approx)	196
Extra Rinse Option	Yes	CARTON DIMENSIONS (In.)	
Spin Speeds	4	Width	25.59
Dry Cycles		Depth	25.98
	Auto Dry	Height	37.40
	60 min Dry	Shipping Weight (lbs) (approx.)	209
	Touch Up	Cube Measurement	14.39
Moisture Sensor Dry	Yes	Container Quantity	150 (40' HQ)
Delay	Yes	UPC Code	6-88057-39569-2

Chapter 3 Matters needing attention

3-1. Safety

IMPORTANT SAFETY INSTRUCTIONS

Warning— To reduce the risk of fire, electric shock, or injury to persons when using your appliance, follow basic precautions, including the following:

1. Read all instructions before using the appliance.
2. Use this appliance only for its intended purpose as described in this use and care guide.
3. Use only detergents or softeners recommended for use in this appliance and keep them out of the reach of children.
4. This appliance must be properly installed in accordance with the installation instructions before it is used.
5. Never unplug your appliance by pulling on the power cord. Always grasp the plug firmly and pull straight out from the outlet.
6. Replace immediately worn power cords, loose plugs/power outlets.
7. Unplug your appliance before cleaning or before making any repairs.
8. If your old appliance is not being used, we recommend that you remove the door. This will reduce the possibility of danger to children.
9. Do not operate your appliance in the presence of explosive fumes.
10. Do not use this appliance to wash clothes soaked, spotted or washed in gasoline, dry cleaning solvents or any other explosive or flammable substances that could ignite and explode.
11. Clothes or rags used to clean flammable or explosive materials should not be washed in this appliance till all traces of this material has been removed, to avoid an accident.
12. Do not add or mix any flammable or explosive substances to the wash.
13. Do not operate your appliance when parts are missing or parts are broken.
14. Do not use this appliance for commercial clothes washing.
15. Do not operate this appliance unless all enclosure panels are properly in place.
16. Do not tamper with controls.
17. To reduce risk of injury do not allow children to play in or on the appliance. Close supervision of children is necessary when the appliance is used near children.
18. This appliance must be connected to proper electrical outlet with the correct electrical supply.
19. Proper grounding must be ensured to reduce the risk of shock and fire.

DO NOT CUT OR REMOVE THE GROUNDING PLUG. If you do not have a three-prong electric receptacle outlet in the wall, have a certified electrician install the proper receptacle. The wall receptacle **MUST** be properly grounded.

20. Hydrogen gas may be produced if the water heater has not been used for more than 2 weeks. This could be explosive under certain circumstances. If this is the case, before using this appliance turn on all the hot faucets and let the hot water run for a few minutes. This will let the trapped hydrogen escape. During this process do not turn on an electric appliance, smoke, light a match/lighter or use a flame to avoid an accident, as hydrogen gas is flammable and can explode.
21. Do not dry articles that have been previously cleaned in, washed in, soaked in, or spotted with gasoline, dry-cleaning solvents, or other flammable or explosive substances, as they give off vapors that could ignite or explode.
22. Do not repair or replace any part of the appliance or attempt any servicing unless specifically recommended in the user-repair instructions that you understand and have skills to carry out.
23. Do not use heat dry for articles containing foam rubber or similarly textured rubber-like materials.
24. Do not place items exposed to cooking oils in your appliance. Items contaminated with cooking oils may contribute to a chemical reaction that could cause a load to catch fire.
25. Do not reach into the appliance if the tub or agitator is moving.
26. Do not install or store this appliance where it will be exposed to the weather.

3-2. During Use

SAVE THESE INSTRUCTIONS

Note: These units have a self-locking device. Please wait for 3 minutes after you stop the machine before opening the door.

ELECTRICAL CONNECTIONS

GROUNDING INSTRUCTIONS

This appliance must be grounded. In the event of an electrical short circuit, grounding reduces the risk of electric shock by providing an escape wire for the electric current. This appliance is equipped with a cord having a grounding wire with a grounded plug. The plug must be inserted into an outlet that is properly installed and grounded.



- Improper use of the plug can result in a risk of electric shock.
- Consult a qualified electrician or service person if the grounding instructions are not completely understood or if doubt exists as to whether the appliance is properly grounded.

Wiring Requirements:

- This appliance must be plugged into at least 15 AMP 120 VOLT, 60 HZ GROUNDED OUTLET.

Note: Where a standard two-prong outlet is encountered, it is the personal responsibility and obligation of the consumer to have it replaced with a properly grounded three-prong outlet.

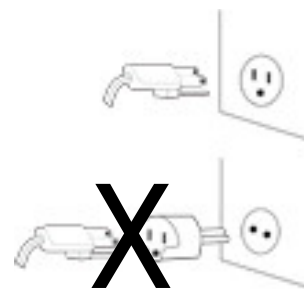

Extension Cords:

We do not recommend that you use an extension cord.



Power Interruptions

Occasionally there may be power interruptions due to thunderstorms or other causes. Remove the power cord from AC outlet when a power outage occurs. When power has been restored re-plug power cord to AC outlet. If outage is for a prolonged period, clean washer before using it again.

Chapter 4 Operational Guidance

Warning - To reduce the risk of fire, electric shock, or injury to persons, read the IMPORTANT SAFETY INSTRUCTIONS before operating this appliance.

Control Panel

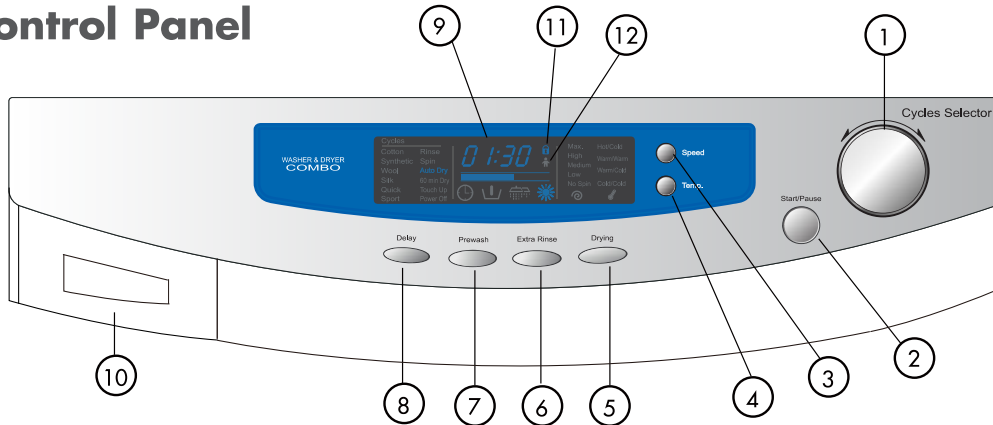

Functions

1. Cycle Selector

To set a desired wash program, turning the knob will light the cycle selected on the control panel. Wash cycles are: Cotton, Synthetic, Wool, Silk, Quick & Sport. Once selected you could press the "Start/Pause" button to start operation.

2. Start/Pause Button

After a cycle, options, spin speed, temperature and dry cycle is selected, press this button to begin wash. During a wash cycle, press this button to pause operation. Press again to resume operation. If dry cycle is selected, the wash load will go into drying program after the wash is done.

3. Spin Speed Selection

By pressing this button, the required spinning speed can be selected. You could choose from Max; High; Medium; Low to No Spin.

The maximum speed will vary when a different program is selected.

4. Temperature Button

Press button to select wash/rinse temperature. Selection choice is hot/cold; warm/warm; warm/cold; cold/cold. The wash/rinse temperature will vary when a different program is selected.

5. Drying Button

To start the dry cycle immediately after the wash cycle, press this button. An indicator will light up showing its activation. When the unit goes in the dry mode the light will flash. To cancel the program press the Start/Pause button before the cycle is complete. Pressing Drying button again will cancel the dry program and turn off the light.

NOTE: Drying cycle is not available in all wash cycles.

6. Extra Rinse Button

Press this button to add an additional rinse cycle to your wash load. A light on the display screen will alert you that the option has been activated. Before the wash cycle goes in the softening mode an additional rinse cycle will be added.

7. Prewash

Press this button to activate the Pre-Wash cycle. The indicator light will light up. Once the wash cycle starts it will first go in the Pre-wash mode and then in the regular wash cycle. During this time the Pre-Wash display light will blink and water will inflow in the 1st compartment of the detergent dispenser. At the end of the cycle the display light will turn off.

8. Delay Start

To select, press the "Delay" function button. The wash cycle will begin at a later time of your choosing. The cycle start will be delayed by 1 hour each time you press the button, to a maximum of 24 hours. After the display shows 24:00, pressing the button one more time will make the display show 00:00. Now you can cancel the delay function without powering off the combo. When selected, the delay icon will light up and will only shut off when the cycle commences. The display shows delay time in hours. Once the selected delay time is reached the machine will START.

9. LCD Display

Shows wash cycle chosen, dry cycle chosen, remaining wash/dry or delay time, spin speed and temperature selection. Indicator light showing delay, prewash, extra rinse of drying will also be displayed. Door lock and child lock functions will be lit when activated.

10. Detergent Distributor

If prewash cycle is chosen, add detergent in the 1st compartment.

Regular washing detergent is to be filled in the 2nd compartment.

Fabric softener if used should be filled in compartment 3

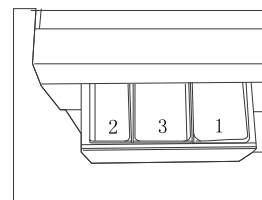

11. Door Light

A lock light will illuminate when the door is locked.



12. Child Lock Indicators

When child lock is activated this indicator will light up. Once the combo is running, press "Delay" and "Start/Pause" at the same time for 3 seconds. This will activate the feature. The LCD display will show "Safe On". Now the selected cycles cannot accidentally be changed by anyone. To cancel press the "Delay" and the "Start/Pause" again for 3 seconds.

Power Supply	<ul style="list-style-type: none"> ▪ 120V/60Hz/15Ams
Water Supply	<ul style="list-style-type: none"> ▪ Turn on the tap and ensure the water flow. <p>Caution: Before starting the washing machine turn on the water faucet to ensure that the water faucet and the water inlet hose are connected and do not leak.</p>
Detergent Supply	<ul style="list-style-type: none"> ▪ The washing result depends on the quality of the detergent except the function performances of the washing machine. There are many brands of detergent in the market. For the best washing result, we suggest you use the detergent that produced less suds for the auto drum washing machine. ▪ Read detergent manufactures instructions for the correct detergent and amount to use. <p>Attention: Put only enough detergent for one load of laundry into dispenser at a time.</p>
Laundry Treatment	<ul style="list-style-type: none"> ▪ Sort out clothes according to type and extent of dirt. There are three types of clothes : cotton, synthetic and woolen (silk) fabrics. ▪ Separate white clothes from colours. ▪ Remove all objects from pockets that may cause damage to the machine, such as keys and coins. ▪ Repair damaged clothing , loose buttons or damaged zippers before washing. ▪ Bed sheets and table clothes should be loosely loaded and not folded. ▪ This washing machine is for household use and designed to mechanically wash clothes.

Type	Cotton	Synthetic	Wool/Silk	Blending	Dry
Max load	13.2lbs	6.6lbs	3.3lbs	6.6lbs	6.6lbs

Chapter 5 Program Introduction

PROGRAM SELECTION

Program Name	Option	Suitable Condition	Load (lbs) below	Program Time
cotton	wash	cotton clothes washing	13.22	1:30
	wash+dry	cotton clothes washing	6.6	3:30
synthetic	wash	synthetic clothes washing	6.6	0:58
	wash+dry	synthetic clothes washing	6.6	2:58
wool	wash	wool clothes washing	3.3	0:50
silk	wash	silk clothes washing	3.3	0:50
quick	wash	for not very dirty clothes	6.6	0:29
sport	wash	for sports clothes	6.6	0:25
rinse	/	/	/	0:22
spin	/	/	/	0:09
AUTO Dry	dry	cotton or synthetic	6.6	2:00
60 min Dry	dry	cotton or synthetic	6.6	1:00
Touch Up	dry	/		0:30
Power off		/		

Chapter 6 Appearance brief introduction

6-1. Name of parts



6-2. Net dimension



height: 850mm / width: 595mm / depth: 600mm

Chapter 7 Disassembly and Installation

7-1. Remove packing materials

As shown in figure1, remove all the packing materials (including the foam base).

Upon opening of the package, water drops may be seen on the plastic bag and the porthole. This is a normal phenomenon resulting from water tests in the factory. Water tests are conducted to check for leakage.

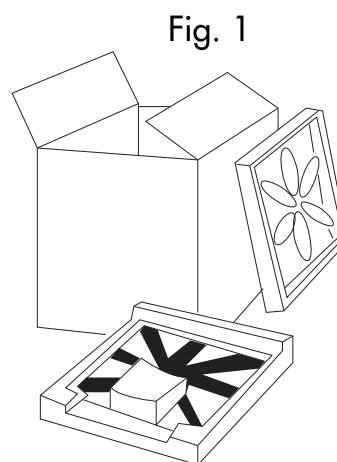

7-2. Dismantle packing bolts

- Remove three transportation bolts as shown in figure 2A. The bolts protect the appliance from shock during transportation. The steps below should be followed before using the appliance:
 1. Remove the back plate of the washing machine. To remove this you must remove three screws holding the panel.
 2. Now you could remove the transportation bolts. While removing the three bolts from the rear of the washing machine, remove the rubber hoses which are behind the transportation bolts inside the unit at the same time. Remove the metal bracket and save in a safe place for later use.
 3. Reinstall the back plate.
 4. Fill the holes left by the bolts with plastic plugs. (Attention: The bolts and rubber hose should be kept in a safe place for later use.) (Fig. 2B)

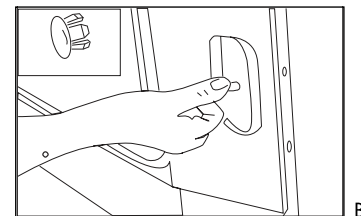
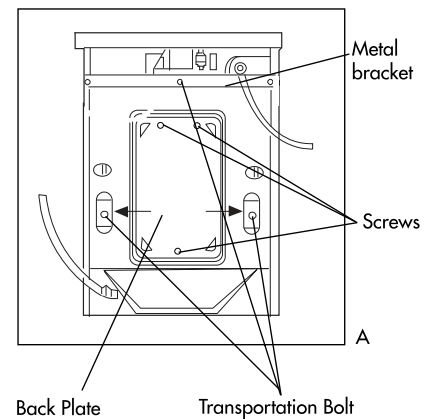

Fig. 2

7-3. Adjusting the washing machine

- Leveling the washing machine: There are adjustable feet under the bottom of the washing machine. Before use, the washing machine should be adjusted, as shown in figure 3, so that it is level.
- Leveling legs can be adjusted by turning them counterclockwise to raise your washer or clockwise to lower your washer.

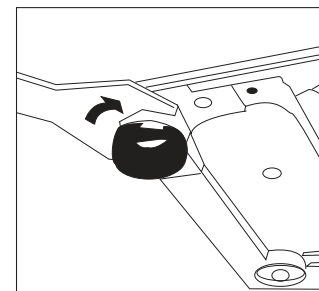

Fig. 3

7-4. Joining the Inlet Hose to the Washing Machine

Connect the nut on the inlet hose to the connector on the water valve.

2. Apply inlet hose to a water tap with cold, fresh water.

Note: Use the hose-set supplied with the appliance. Old hose-sets should not be reused.

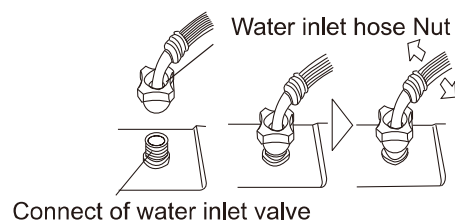

7-5. Connecting to the Power Supply

Before connecting to the power supply, check:

The socket is adequate for the maximum power of the washing machine

(For safety, fuses in the power circuit should be rated for no less than 15A).

The voltage should meet the requirement.

The power outlet should be capable of accepting the washing machine plug.

Connect the machine to an earthed socket outlet.

Chapter 8 Wiring circuit

8-1. Wiring circuit

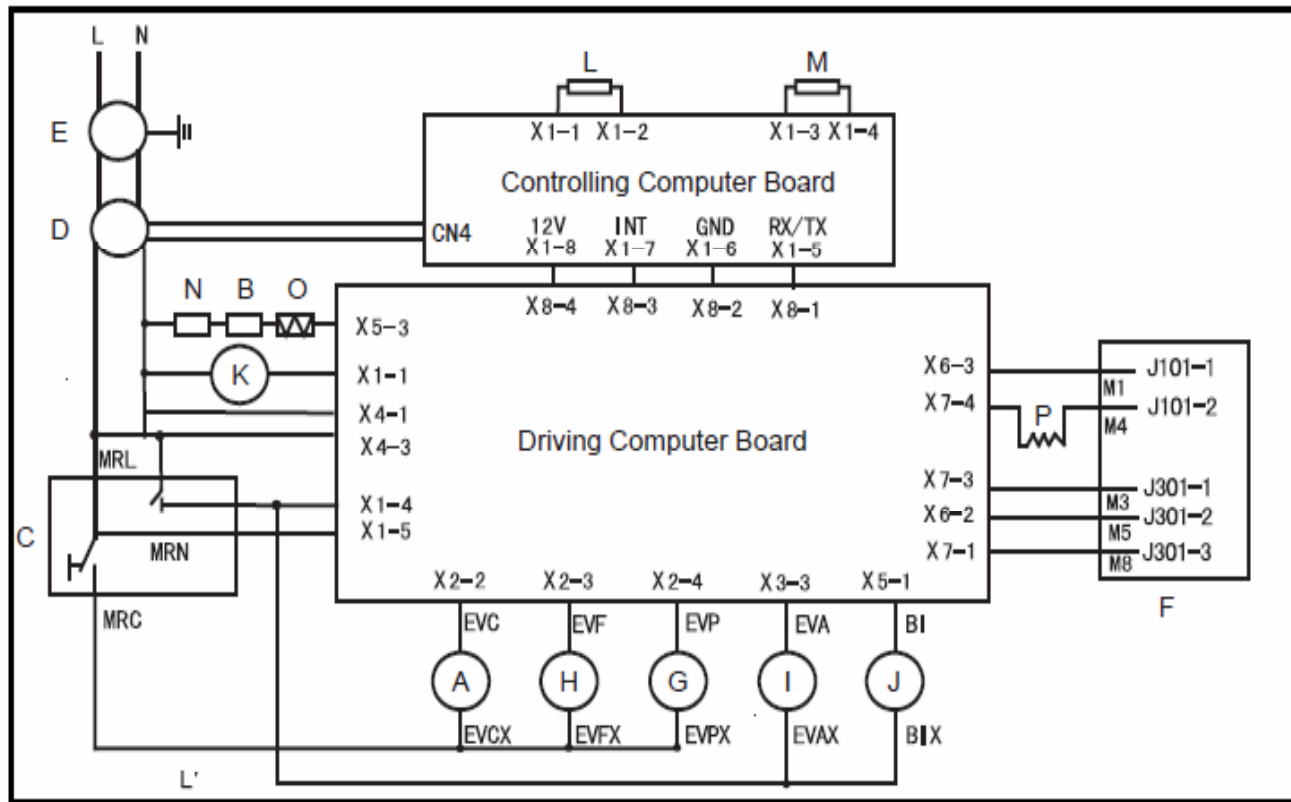

A:water inlet electromagnetic valve for hot water

B:heater(for drying)

C:door engine(Micro-delay door switch)

D:cycle selector

E:filter

F:motor

G:water inlet electromagnetic valve for pre-washing

H: water inlet electromagnetic valve for main washing

I: water inlet electromagnetic valve for drying

J:pump

K:drying fan motor

L:water level sensor

M: drying temperature sensor

N:fuse

O:thermostat

P:inductance

8-2. Self check

Self test program (suit for HWD1600)

Press extra rinse button and then power on. Keep pressing the extra rinse button for 4 seconds. The screen will display "tEst". Then press start button. Washing machine will start self test program.

The procedure of self test program:

First PCB will test whether the dryer temperature sensor is normal or not. If normal the unit will go on self test. If not PCB will display failure code. Then the procedure is as below:

1. Lock the door. All the icon is light for 3 seconds. Display 88:88. If the door can't be locked it will display ERR1.
2. Hot water inlet for 3 seconds. Main wash inlet for 3 seconds. Prewash inlet for 3 seconds. Condensing inlet for 3 seconds. Soft wash inlet to 1 water level. LCD displays 77:77.
3. If washing machine can not reach set water level it will display ERR5. (If there is no water inlet washing machine inspect that water level reach the set water level or overflow water level. It will display ERR8)
4. Rotate drum clockwise for 5 seconds. Then stop for 3 seconds. Display 66:66.
5. Rotate drum counterclockwise for 5 seconds. Then stop for 3 seconds. LCD displays 55:55.
6. Dryer heating for 5 seconds. Display 33:33
7. Drain out the water for 5 seconds. Display 11:11. If all the water can not be drained out it will display ERR2.
8. The self test end. Display End.

Note: If you want to stop the program during self test program you can power off the machine.

Chapter 9 Error Display and troubleshooting

9-1. Error Display

Err1

Error message:Door is not properly shut 20s after program is started.

Troubleshooting:

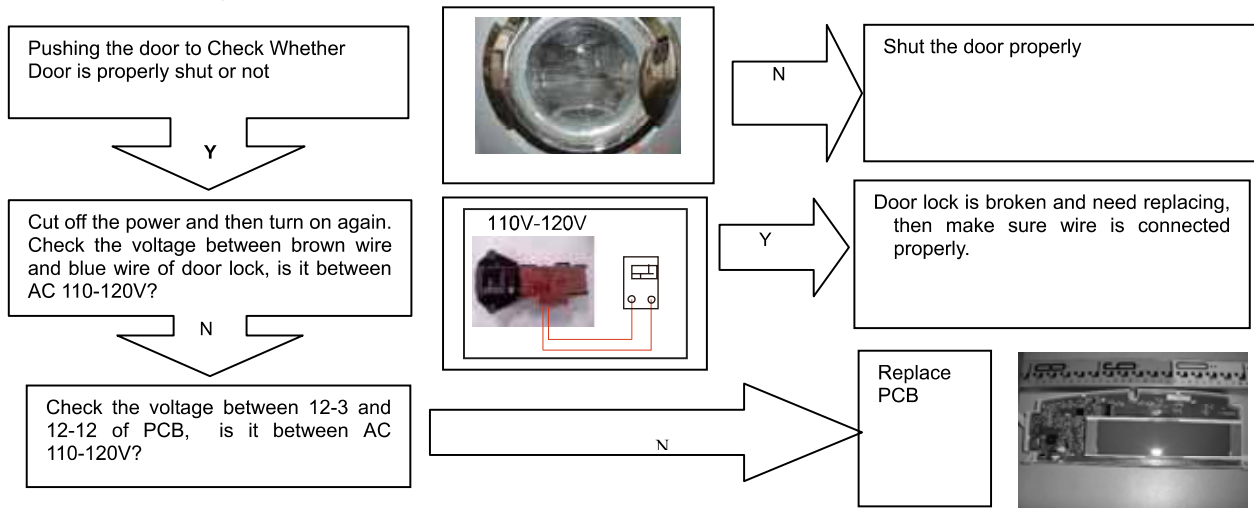

Err2

Error message: Drainage error, water not emptied within 4 min.

Troubleshooting:

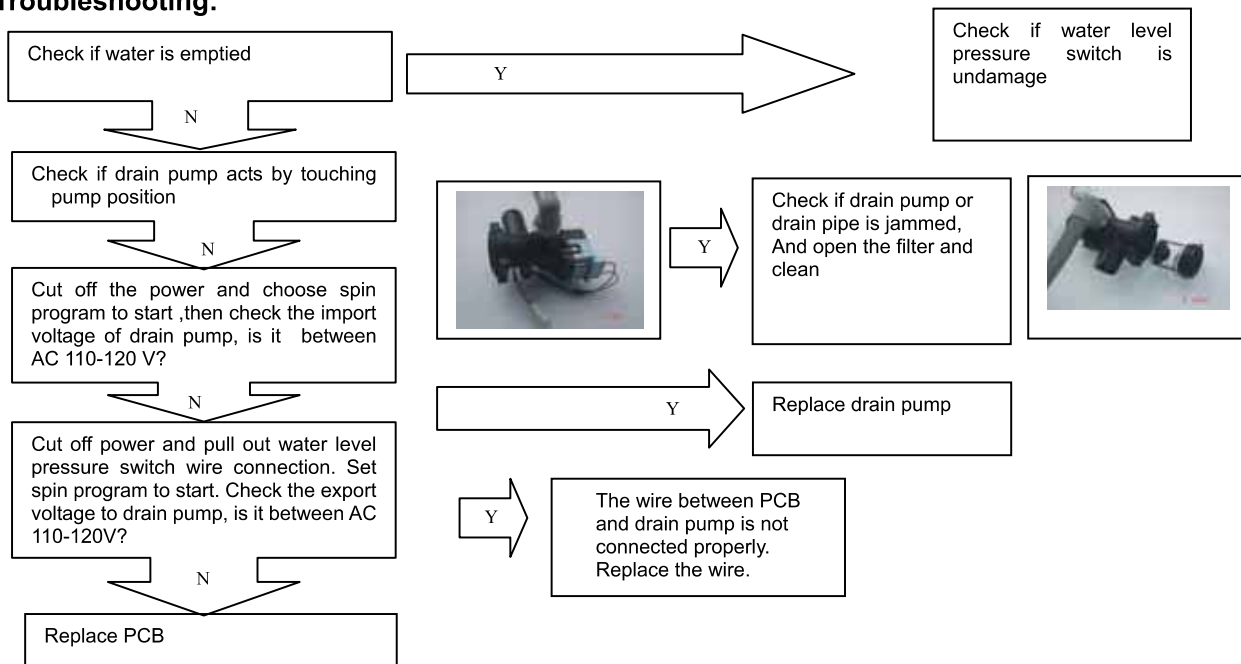

Err5

Error message: The required water level is not reached within 8 min.

Trouble shooting:

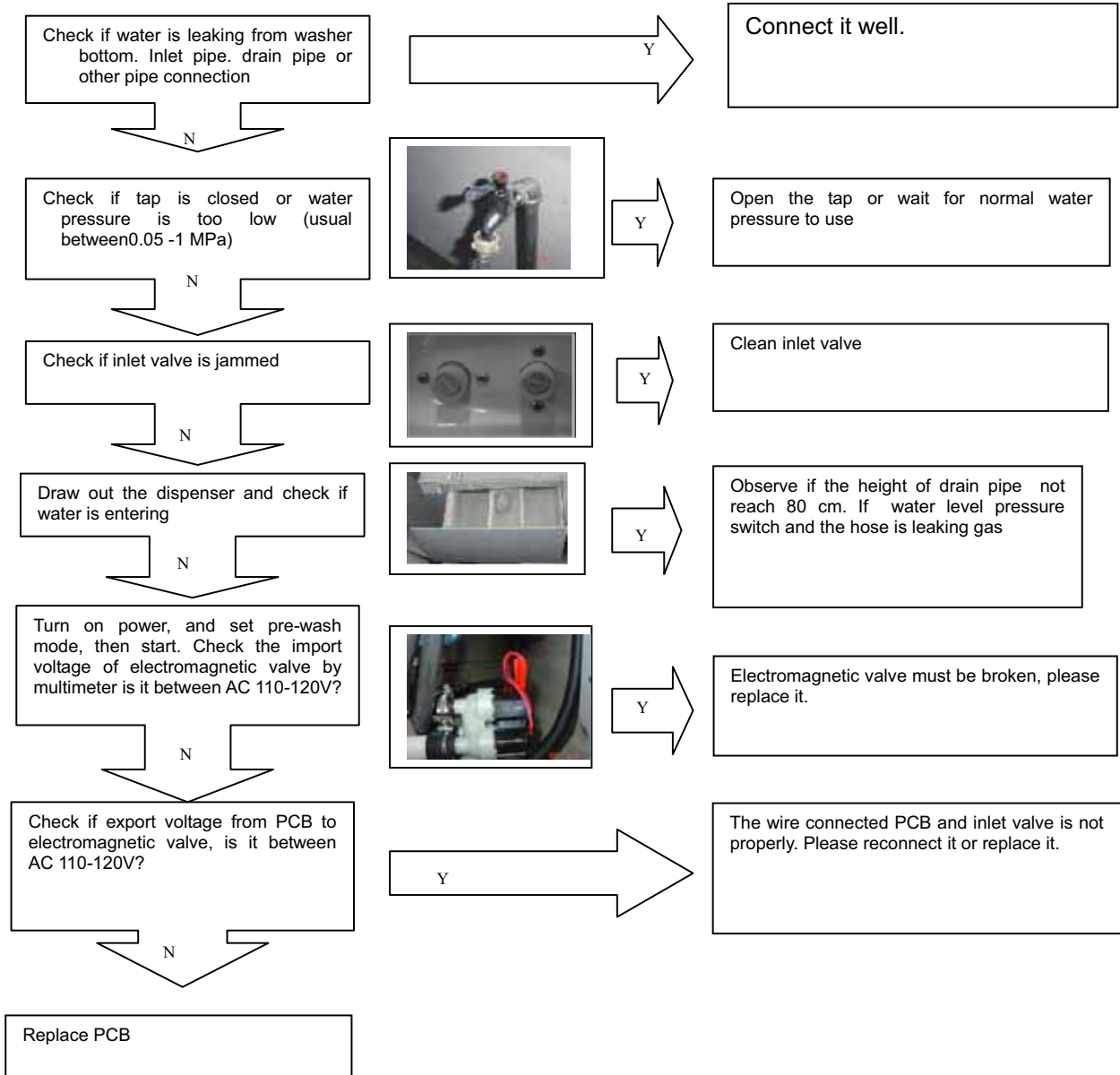

Err7

Error message. Motor overheat protection or is damaged.

Troubleshooting:

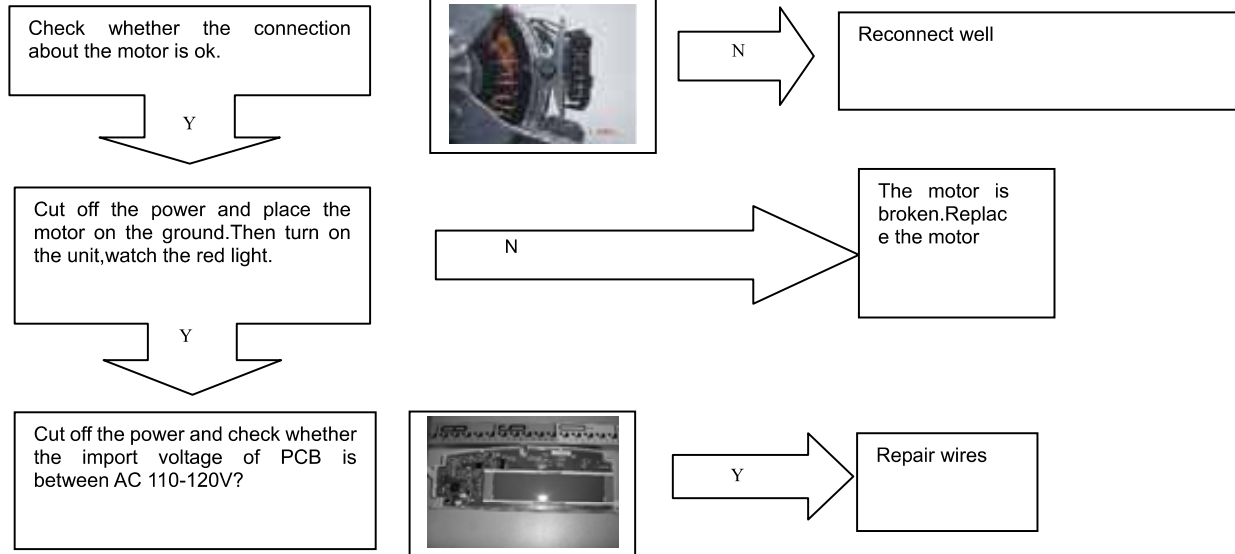

Err8

Error message. Water level exceeds protection value.

Troubleshooting:

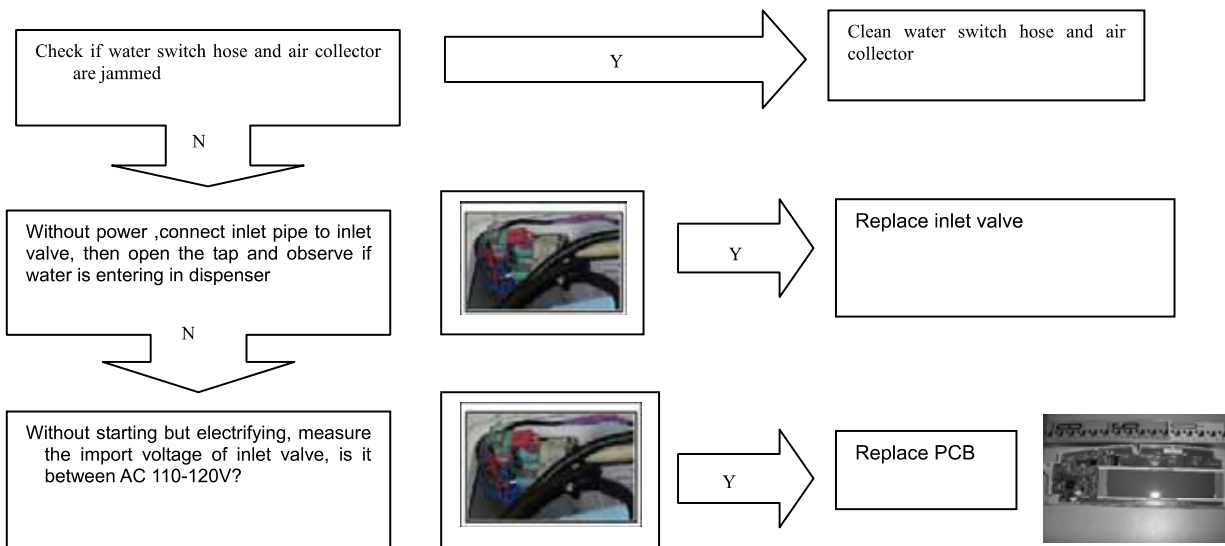

Er10

Error message: The water level sensor circuit short cut or open

Troubleshooting:

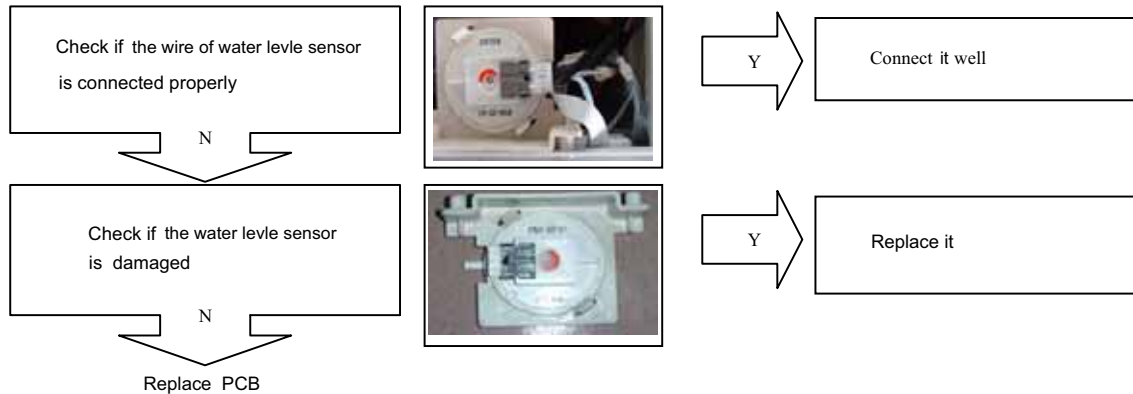

Er12

Failure information: waterlevel abnormity during drying cycle

There are several reasons at it:

1. The drain pump is broken; 2.The connection between drain pump and the wire is abnormal; 3. The amount of water flowing adapter is too much; 4.PCB is broken.

Er13

Failure information: Sheathed Heating Elements or drying motor abnormity.

There are several reasons at it:

1. Thermal link is broken; 2.The connection between thermal link and wire is not suitable; 3. Sheathed heating elements is broken; 4. The connection between sheathed heating elements and wire is not suitable; 5. Thermostat is broken; 6. The connection between thermostat and wire is not suitable; 7.PCB is broken.

Unb

Failure information: when spined, clothes is unevenly distributed.

Processing mode: Quiver and scatter the clothes to make it even. If there is still any alarm, please replace the PCB.

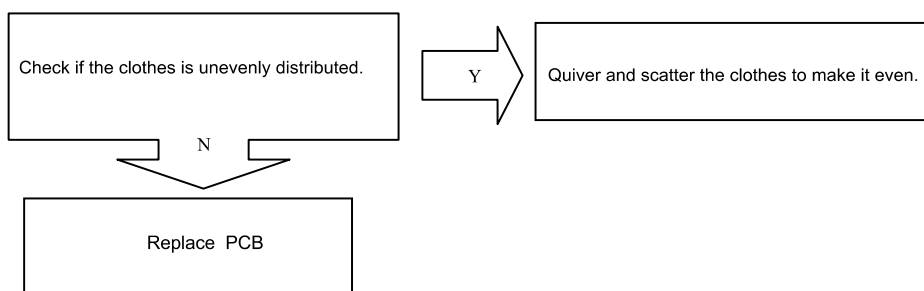

HWD1600

Failure : Display nothing

Troubleshooting:

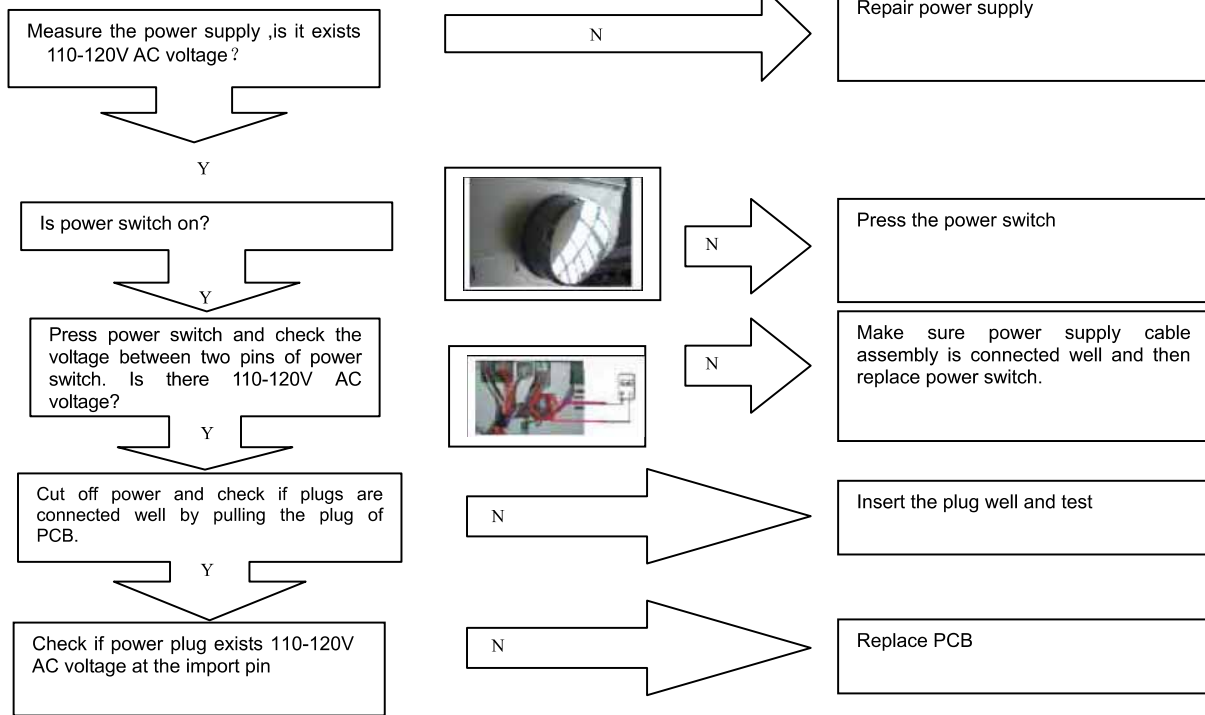

Failure : No water inletting

Troubleshooting:

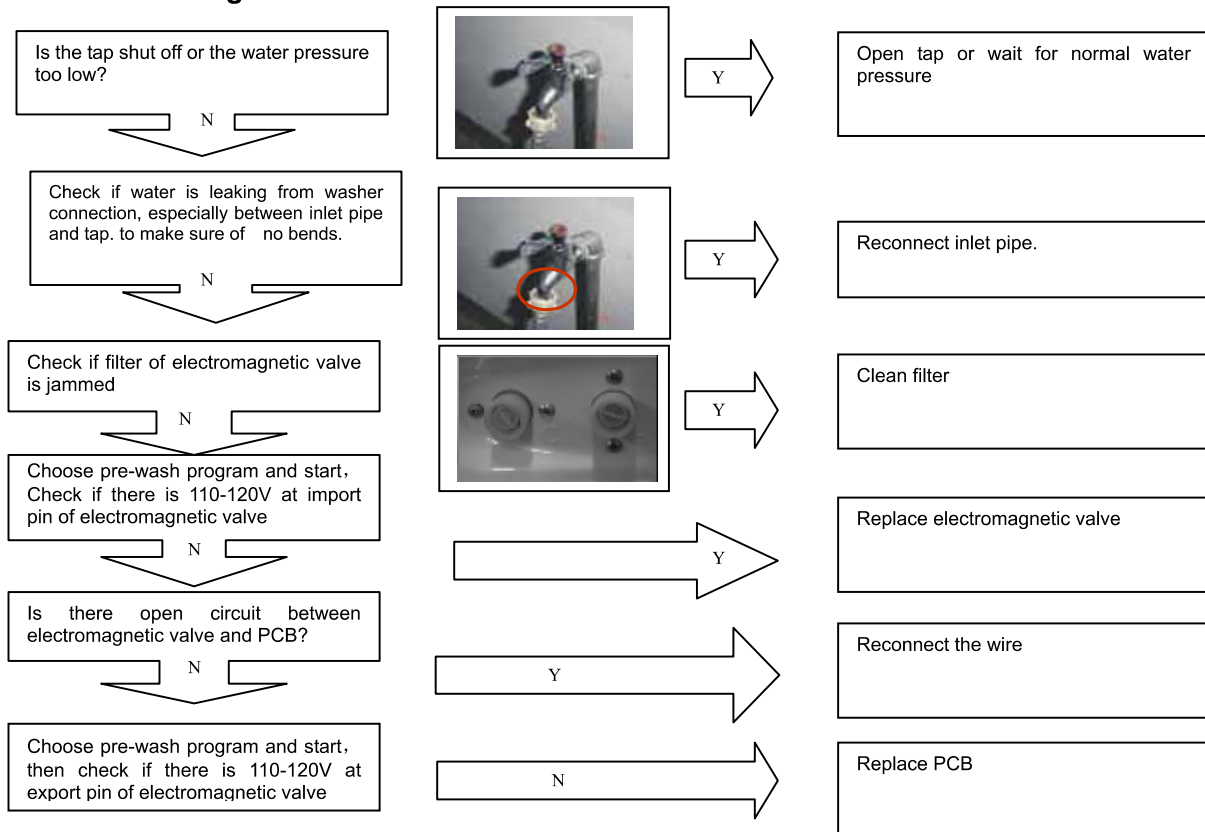

Failure: no draining

Troubleshooting:

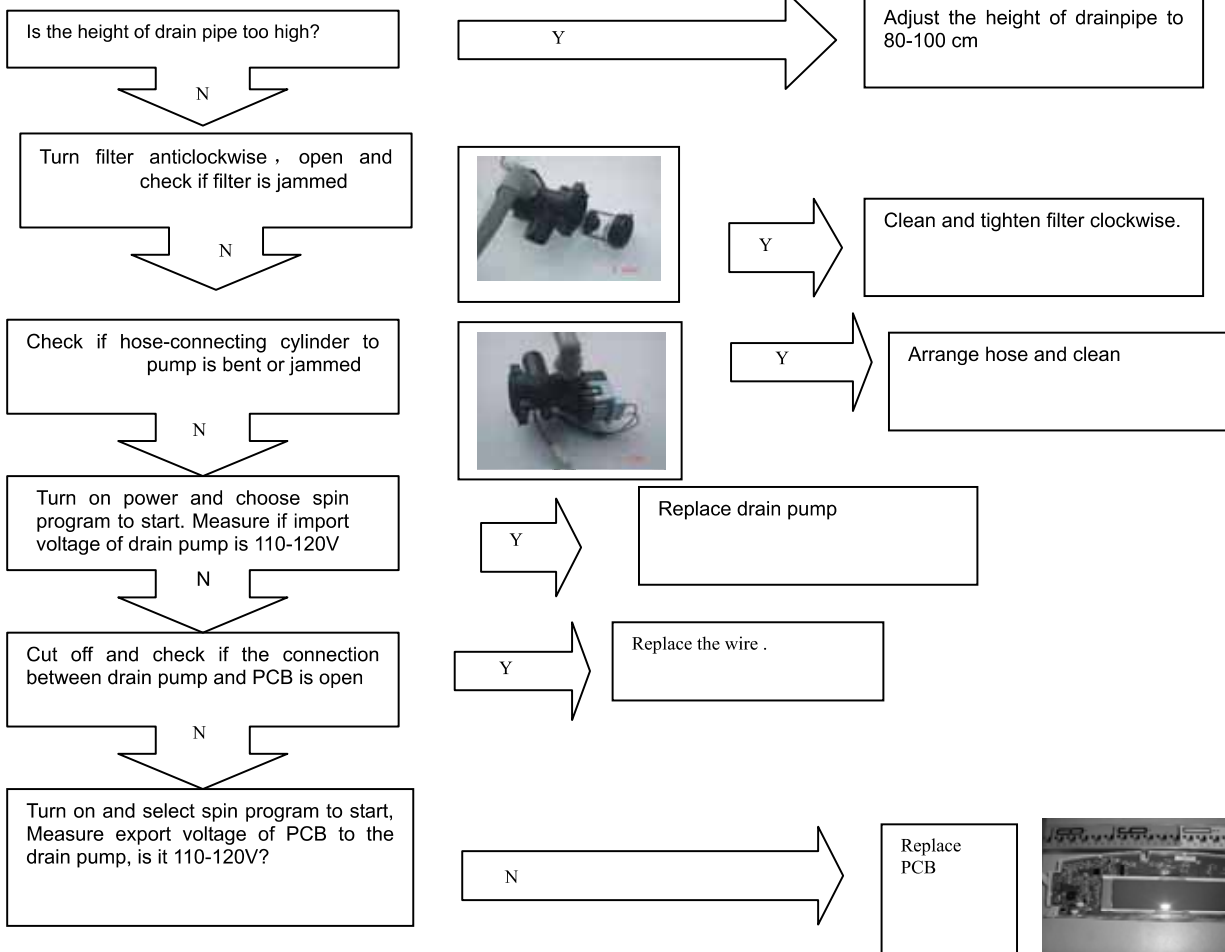

Failure: water leaking
Troubleshooting:

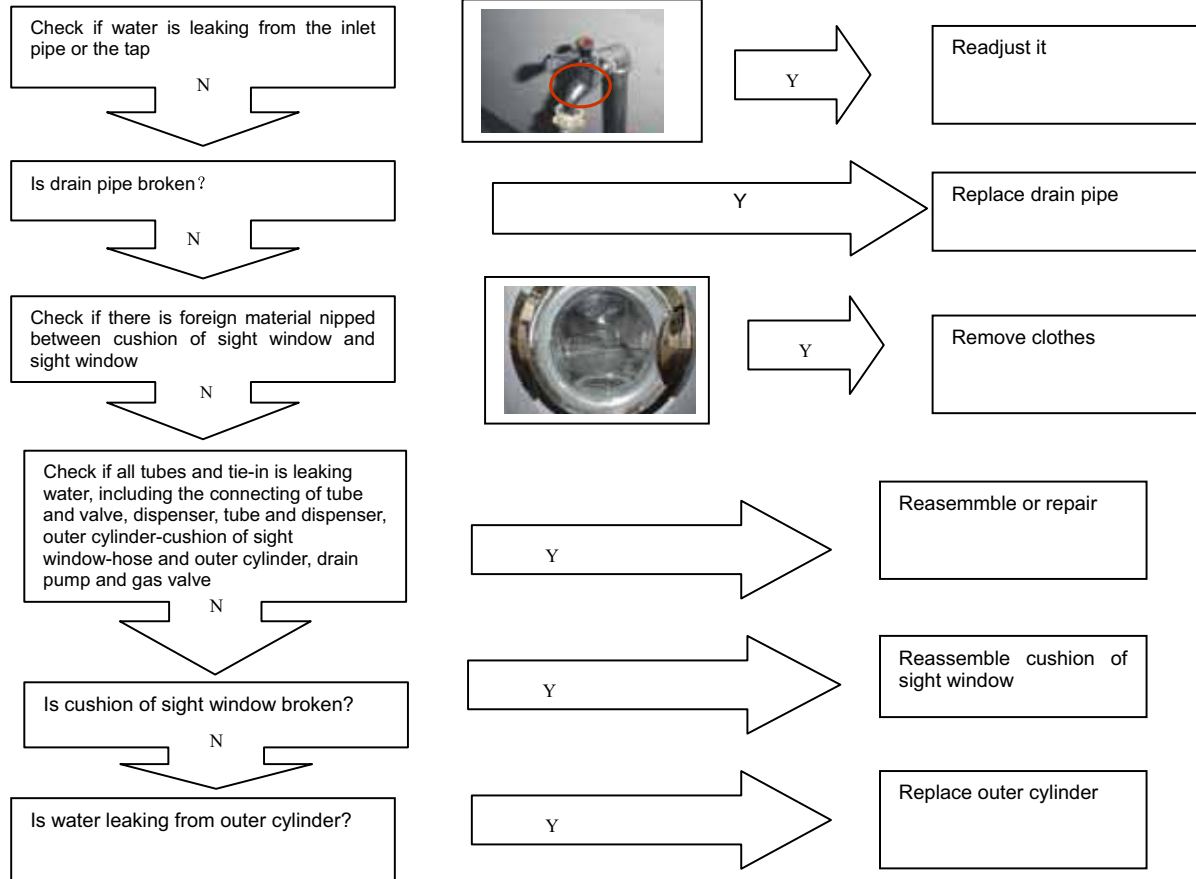

Sincere Forever