



**CONSUMER SERVICES TECHNICAL
EDUCATION GROUP PRESENTS**

L-74

22" COMPACT AUTOMATIC WASHER



MODEL LCE4332PQ

**JOB AID
Part No. 8178436**

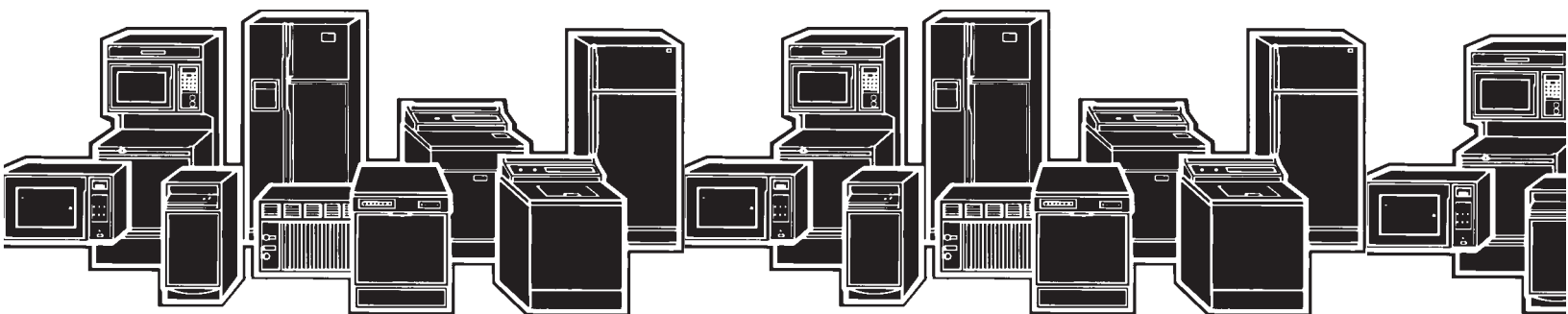

FORWARD

This Whirlpool Job Aid “22” Compact Automatic Washer” (Part No. 8178436), provides the technician with information on the installation, operation, and service of the 22” Compact Automatic Washer. It is to be used as a training Job Aid and Service Manual. For specific information on the model being serviced, refer to the “Use and Care Guide,” or “Tech Sheet” provided with the washer.

The Wiring Diagram and Strip Circuits used in this Job Aid are typical and should be used for training purposes only. Always use the Wiring Diagram supplied with the product when servicing the unit.

GOALS AND OBJECTIVES

The goal of this Job Aid is to provide detailed information that will enable the service technician to properly diagnose malfunctions and repair the Whirlpool 22” Compact Automatic Washer.

The objectives of this Job Aid are to:

- Understand and follow proper safety precautions.
- Successfully troubleshoot and diagnose malfunctions.
- Successfully perform necessary repairs.
- Successfully return the washer to its proper operational status.

WHIRLPOOL CORPORATION assumes no responsibility for any repairs made on our products by anyone other than Authorized Service Technicians.

TABLE OF CONTENTS

Page

GENERAL	1-1
Safety First.....	1-1
Model & Serial Number Designations.....	1-2
Model & Serial Number Label And Tech Sheet Locations.....	1-3
Specifications.....	1-4
Whirlpool Compact Washer Warranty.....	1-5
INSTALLATION INFORMATION	2-1
Installation Requirements.....	2-1
Permanent Installation Instructions.....	2-5
Portable Installation Instructions.....	2-10
PRODUCT OPERATION	3-1
Theory Of Operation.....	3-1
Washer Use.....	3-3
COMPONENT ACCESS	4-1
Component Locations.....	4-1
Removing The Pressure Switch, Water Inlet Valves, Lid Switch, Interface And Electronic Control Boards.....	4-2
Removing The Basket.....	4-6
Removing The Tub.....	4-8
Removing The Brake And Gearcase Assemblies.....	4-11
Removing The Capacitor And Drive Motor.....	4-14
Removing The Brake Actuator Assembly.....	4-16
Removing The Drain Pump.....	4-18
COMPONENT TESTING	5-1
Pressure Switch.....	5-1
Water Inlet Valve Solenoids.....	5-2
Drive Motor Capacitor.....	5-2
Brake Actuator.....	5-3
Drive Motor.....	5-4
Drain Pump.....	5-4
DIAGNOSTICS & TROUBLESHOOTING	6-1
Diagnostics.....	6-1
Time Charts.....	6-2
Self Diagnostic Failure—Alarm Codes.....	6-3
Service Routine.....	6-4
Troubleshooting Guide.....	6-6
WIRING DIAGRAM & STRIP CIRCUITS	7-1
Wiring Diagram.....	7-1
Strip Circuits.....	7-2

— NOTES —

GENERAL SAFETY FIRST

Your safety and the safety of others is very important.

We have provided many important safety messages in this Job Aid and on the appliance. Always read and obey all safety messages.



This is the safety alert symbol.

This symbol alerts you to hazards that can kill or hurt you and others.

All safety messages will follow the safety alert symbol and either the word “DANGER” or “WARNING.” These words mean:

! DANGER

You can be killed or seriously injured if you don't immediately follow instructions.

! WARNING

You can be killed or seriously injured if you don't follow instructions.

All safety messages will tell you what the potential hazard is, tell you how to reduce the chance of injury, and tell you what can happen if the instructions are not followed.

MODEL & SERIAL NUMBER DESIGNATIONS

MODEL NUMBER

MODEL NUMBER	L	C	E	4	3	3	2	P	Q	0
Product Group C = Laundry, Commercial L = Laundry, Domestic G = Laundry, Gold										
Product Identification A = Commercial A/W B = Large Capacity A/W, 24" -U.S. C = 22" Compact A/W D = Electric Dryer, 120 volt E = Electric Dryer, 240 volt G = Gas Dryer H = Electric Dryer, (Brazilian) L = Large Capacity A/W, 27" U.S. K = Kit M = Reg. Capacity A/W - Mexico P = 24" Compact A/W S = Stack Commercial Dryer or Super Capacity 27" A/W T = Thin Twin X = 96 Ex. Large Capacity A/W 27" Z = 5KG A/W 22" - Brazil										
Feature Code/Variation Lines E = Electronic or Electric Thin Twin P = Pushbutton R = Rotary T = Circuit City S = Water Saver Q = Rotary Quiet N = No Match G = Gas Thin Twin C = Clean Touch L = Special W = Web V = Variation Line										
Cycles - Domestic (1 - 9)										
A/W (1 - 6) = Washer Speed Combinations										
Washer (1 - 8) = Wash/Spin Combinations										
Washer (1 - 5) = Water Levels										
Year of Introduction P = 2004										
Color Code W = White, N = Almond, Q = White on White, Z = Almond on Almond										
Engineering Change (numeric)										

SERIAL NUMBER

SERIAL NUMBER	CR	R	01	00102
DIVISION RESPONSIBILITY C = Clyde, OH R = Multibras Rio Claro, Brazil				
YEAR OF PRODUCTION R = 2004				
WEEK OF PRODUCTION 01 = 1st Week				
PRODUCT SEQUENCE NUMBER				

MODEL & SERIAL NUMBER LABEL AND TECH SHEET LOCATIONS

The Model/Serial Number label and Tech Sheet locations are shown below.



SPECIFICATIONS

WASHER MODEL LCE4332PQ0	
WASHING SYSTEM	
Washing System	Agitator
Agitator Type	Single Action
Basket Spinning (High)	750 rpm
Dispenser	Yes - 1 drawer
Strokes Per Minute	
Heavy Duty (Max)	64 spm
Normal (Max)	68 spm
Quick Wash (Max)	64 spm
Delicate (Max)	35 spm
ELECTRICAL	
Nominal Voltage	120 VAC
Voltage Range	100 - 130 VAC
Frequency	60 Hz
Current (Rated)	5 amps
Motor	
Power	1/4 HP
Rotation	1625 rpm
Current (Rated)	3 amps
Type	PSC - Bi-directional
Drain Pump	
Power	36 Watts
Current	0.8 amps
Flow	24 liters/minute
Capacitance	45 μ F
Circuit Breaker	15 amps (recommended)
HYDRAULIC	
Max. Water Consumption (All Cycles)	
High	33 gal./124 l
Medium	17 gal./64 l
Water Pressure	
Maximum	690 kPa/100 psi
Minimum	34.5 kPa/5 psi
Water Level	
High	Just below balance ring
Medium	5 rows below balance ring
DIMENSIONS	
Net Weight	86.4 lbs. (39.2 kg)
Height	38.2 in. (970 mm)
Width	22.2 in. (565 mm)
Depth	24.6 in. (625 mm)
Height W/Lid Open	51.1 in. (1300 mm)
Weight W/Package	94.8 lbs. (43 kg)
Height W/Package	41.7 in. (1060 mm)
Depth W/Package	26.6 in. (675 mm)
Width W/Package	25 in. (635 mm)

WHIRLPOOL COMPACT WASHER WARRANTY

ONE-YEAR FULL WARRANTY

For one year from the date of purchase, when this washer is operated and maintained according to instructions attached to or furnished with the product, Whirlpool Corporation will pay for FSP replacement parts and repair labor costs to correct defects in materials or workmanship. Service must be provided by a Whirlpool designated service company.

SECOND THROUGH FIFTH YEAR LIMITED WARRANTY ON TOP, LID, AND GEARCASE ASSEMBLY

For the second through the fifth year from the date of purchase when this washer is operated and maintained according to instructions attached to or furnished with the product, Whirlpool Corporation will pay for FSP replacement parts for any top and lid rust and any part of the gearcase assembly, if defective in materials or workmanship.

SECOND THROUGH TENTH YEAR LIMITED WARRANTY ON OUTER TUB

For the second through the tenth year from the date of purchase when this washer is operated and maintained according to instructions attached to or furnished with the product, Whirlpool Corporation will pay for FSP replacement parts for the outer tub should it crack or fail to contain water, if defective in materials or workmanship.

Whirlpool Corporation will not pay for:

1. Service calls to correct the installation of your washer, to instruct you how to use your washer, or to replace house fuses or correct house wiring or plumbing.
 2. Repairs when your washer is used in other than normal, single-family household use.
 3. Damage resulting from accident, alteration, misuse, abuse, fire, flood, acts of God, improper installation, not in accordance with local electrical and plumbing codes, or use of products not approved by Whirlpool Corporation.
 4. Any labor costs during the limited warranty periods.
 5. Replacement parts or repair labor costs for units operated outside the United States and Canada.
 6. Pickup and delivery. This product is designed to be repaired in the home.
 7. Repairs to parts or systems resulting from unauthorized modifications made to the appliance.
 8. In Canada, travel or transportation expenses for customers who reside in remote areas.
-

WHIRLPOOL CORPORATION AND WHIRLPOOL CANADA INC. SHALL NOT BE LIABLE FOR INCIDENTAL OR CONSEQUENTIAL DAMAGES.

Some states and provinces do not allow the exclusion or limitation of incidental or consequential damages so this exclusion or limitation may not apply to you. This warranty gives you specific legal rights and you may also have other rights which vary from state to state or province to province.

Outside the 50 United States and Canada, this warranty does not apply. Contact your authorized Whirlpool dealer to determine if another warranty applies.

If you need service first see "Troubleshooting" in the "Use & Care Guide." Additional help can be found by checking "Assistance or Service" or call our Customer Interaction Center at **1-800-253-1301** from anywhere in the U.S.A., or write: Whirlpool Brand Home Appliances, Customer Interaction Center, 553 Benson Road, Benton Harbor, MI 49022-2692. In Canada, call Whirlpool Canada Inc. at **1-800-807-6777**.

— NOTES —

INSTALLATION INFORMATION

INSTALLATION REQUIREMENTS

TOOLS AND PARTS

Assemble the required tools and parts before starting installation. Read and follow the instructions provided with any tools listed here.

The parts supplied are in the washer basket.

Portable Installation

Tools needed:

- Pliers that open to 1-9/16" (3.95 cm)
- Utility knife
- Flashlight (optional)

Parts supplied:

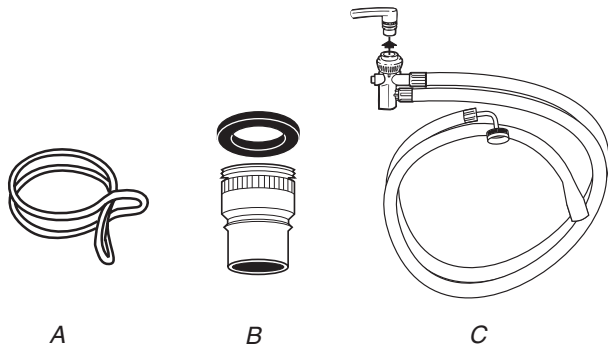

- A. Silver, double-wire hose clamp (for the bottom of the drain hose)
 B. Faucet adapter
 C. Fill-and-drain hose

NOTE: To change a permanent installation to a portable installation, kit #285768 is required.

Permanent Installation

Tools needed:

- Pliers that open to 1-9/16" (3.95 cm)
- Flashlight (optional)
- Adjustable or open end wrench 9/16" (14 mm)
- Level
- Wood block
- Utility knife
- Measuring tape

Parts supplied:

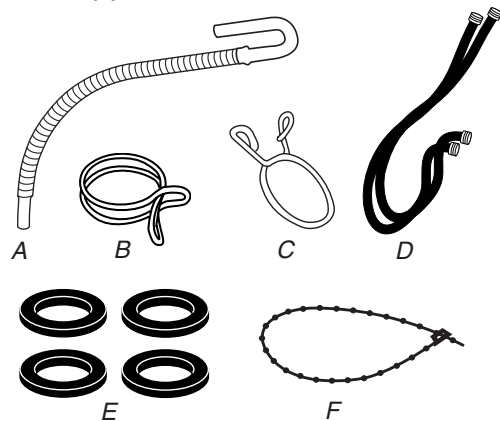

- A. Drain hose
 B. Silver, double-wire hose clamp (for the bottom of the drain hose)
 C. Yellow, single-wire hose clamp (for the top of the drain hose)
 D. Water inlet hoses (2)
 E. Flat water inlet hose washers (4)
 F. Beaded tie strap

NOTE: To change a portable installation to a permanent installation, kit #4396746 is required.

Alternate Parts

Your installation may require additional parts. For ordering information, please refer to the “Assistance or Service” section of the “Use & Care Guide.”

If You Have:	You Will Need to Buy:
Laundry tub or standpipe taller than 72" (183 cm)	Sump pump system (if not already available)
1" (2.5 cm) diameter standpipe	2" (5 cm) diameter to 1" diameter standpipe adapter #3363920
Overhead sewer	Standard 20 gal. (76 L) 39" (99 cm) tall drain tub or utility sink, sump pump and connectors (available from local plumbing suppliers)
Floor drain	Siphon break, #285320 ; additional drain hose, #3357090 and connector kit, #285442
Water faucets beyond reach of fill hoses	2 longer water fill hoses: 6 ft (1.8 m) #76314 , 10 ft (3.0 m) #350008
Drain hose too short	Drain hose, #388423 and hose kit, #285442
Drain hose that is too long	Hose kit, #285442
Lint clogged drain	Drain protector, #367031

LOCATION REQUIREMENTS

Selecting the proper location for your washer improves performance and minimizes noise and possible washer “walk.”

Your washer can be installed in a basement, laundry room, closet, or recessed area (see “Drain System”).

IMPORTANT: Do not install or store the washer where it will be exposed to the weather.

Proper installation is your responsibility.

You Will Need:

- A water heater set to deliver 120°F (49°C) water to the washer.
- A grounded electrical outlet located within 5 ft (1.5 m) of where the power cord is attached to the back of the washer (see “Electrical Requirements”).

- Hot and cold water faucets located within 3-1/2 ft (1.1 m) of the hot and cold water fill valves, and water pressure of 5-100 psi (34.5-690 kPa).
- A level floor with a maximum slope of 3/4" (2.0 cm) under entire washer. Installing the washer on carpeting is not recommended.
- A sturdy floor to support the washer weight (washer, water and load) of 260 lbs (118 kgs).

Do not store or operate your washer in temperatures at or below 32°F (0°C). Some water can remain in the washer and can cause damage in low temperatures. See “Washer Care” in the “Use & Care Guide” for winterizing information.

Recessed area or closet installation

The dimensions shown are for the recommended spacing allowed, except the closet door ventilation openings. The dimensions shown for the closet door ventilation openings are the minimum required.

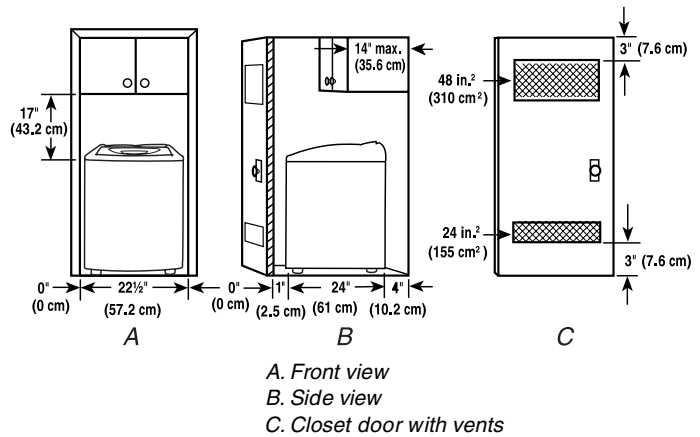

- Additional spacing should be considered for ease of installation and servicing.
- Additional clearances may be required for wall, door and floor moldings.
- Additional spacing of 1" (2.5 cm) on all sides of the washer is recommended to reduce noise transfer.
- If a closet door is installed, the minimum air openings in the top and bottom of the door are required. Louvered doors with air openings in the top and bottom are acceptable.
- Companion appliance spacing should also be considered.

ELECTRICAL REQUIREMENTS

⚠ WARNING



Electrical Shock Hazard

Plug into a grounded 3 prong outlet.

Do not remove ground prong.

Do not use an adapter.

Do not use an extension cord.

Failure to follow these instructions can result in death, fire, or electrical shock.

- A 120-volt, 60-Hz., AC-only, 15- or 20-ampere, fused electrical supply is required. A time-delay fuse, or circuit breaker, is recommended. It is recommended that a separate circuit serving only this appliance be provided.
- This washer is equipped with a power supply cord having a 3 prong grounding plug.
- To minimize possible shock hazard, the cord must be plugged into a mating, 3 prong, grounding-type outlet, grounded in accordance with local codes and ordinances. If a mating outlet is not available, it is the personal responsibility and obligation of the customer to have the properly grounded outlet installed by a qualified electrician.

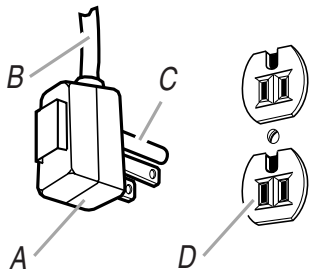

A. 3 prong grounding plug
B. Power supply cord
C. Ground prong
D. 3 prong grounding-type outlet

- If codes permit and a separate ground wire is used, it is recommended that a qualified electrician determine that the ground path is adequate.
- Do not ground to a gas pipe.
- Check with a qualified electrician if you are not sure the washer is properly grounded.
- Do not have a fuse in the neutral or ground circuit.

GROUNDING INSTRUCTIONS

For a grounded, cord-connected washer:

This washer must be grounded. In the event of a malfunction or breakdown, grounding will reduce the risk of electrical shock by providing a path of least resistance for electric current. This washer is equipped with a cord having an equipment-grounding conductor and a grounding plug. The plug must be plugged into an appropriate outlet that is properly installed and grounded in accordance with all local codes and ordinances.

WARNING: Improper connection of the equipment-grounding conductor can result in a risk of electric shock. Check with a qualified electrician or serviceman if you are in doubt as to whether the appliance is properly grounded.

Do not modify the plug provided with the appliance. If it will not fit the outlet, have a proper outlet installed by a qualified electrician.

For a permanently connected washer:

This washer must be connected to a grounded metal, permanent wiring system, or an equipment-grounding conductor must be run with the circuit conductors and connected to the equipment-grounding terminal or lead on the appliance.

REMOVE SHIPPING MATERIAL

!WARNING

Excessive Weight Hazard

Use two or more people to move and install washer.

Failure to do so can result in back or other injury.

Before you install your washer, remove all shipping material.

1. To protect the floor, place two corner posts from the shipping material on the floor in back of the washer.
2. Firmly grasp the body of the washer and gently lay it on the corner posts.
3. Remove plastic foam packaging from under washer.

4. For permanently installed compact washers only, use an adjustable wrench to turn the washer legs out approximately 3/4" (2.0 cm). This is the recommended setting. Later adjustment may be needed.

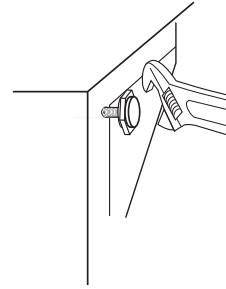

5. Stand the washer up.
6. Remove the tape from the washer lid. Open the washer lid and remove the foam shipping piece, parts bag, and hoses from the washer basket. Close the lid.

NOTE: If you are using a permanent installation, proceed to page 2-5. If you are using a portable installation, proceed to page 2-10.

PERMANENT INSTALLATION INSTRUCTIONS

⚠ WARNING

Excessive Weight Hazard

Use two or more people to move and install washer.

Failure to do so can result in back or other injury.

BEFORE YOU START

- To prevent floor damage, set the washer onto cardboard before moving across floor.
- Move the washer to within approximately 3 ft (90 cm) of the final location.

DRAIN SYSTEM

The washer can be installed using the standpipe drain system (floor or wall), the laundry tub drain system, or the floor drain system. Select the drain hose installation method you need.

Standpipe drain system - wall or floor (views A & B)

The standpipe drain requires a minimum diameter standpipe of 2" (5 cm). The minimum carry-away capacity can be no less than 13 gallons (49.2 L) per minute. A 2" (5 cm) diameter to 1" (2.5 cm) diameter standpipe adapter kit is available (see "Alternate Parts" on page 2-2).

The top of the standpipe must be at least 39" (99 cm) high and no higher than 72" (183 cm) from the bottom of the washer.

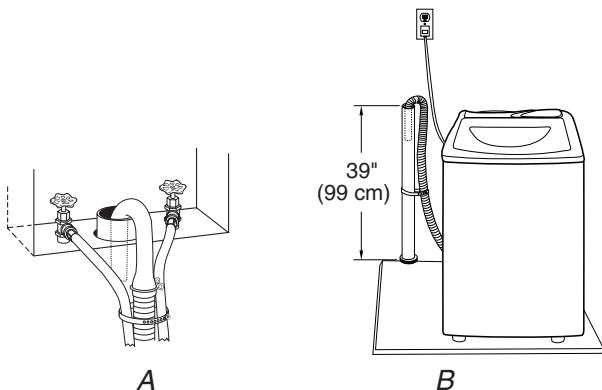

Laundry tub drain system (view A)

The laundry tub requires a minimum carry-away capacity of 13 gal. (49.2 L) per minute.

The top of the laundry tub must be at least 39" (99 cm) above the floor and no higher than 72" (183 cm) from the bottom of the washer.

Floor drain system (view B)

The floor drain system requires a siphon break that may be purchased separately (see "Alternate Parts" on page 2-2).

The siphon break must be a minimum of 28" (71 cm) from the bottom of the washer. Additional hoses might be needed.

The minimum carry-away capacity can be no less than 13 gallon (49.2 L) per minute.

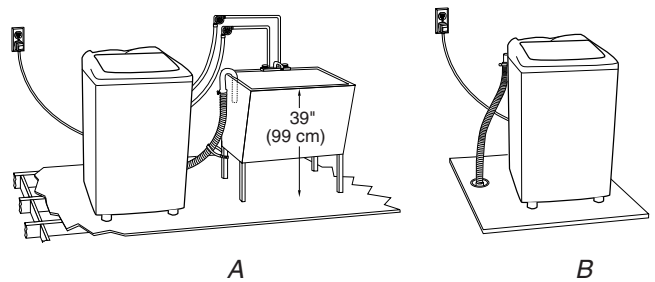

CONNECT DRAIN HOSE

Proper connection of the drain hose will protect your floors from damage due to water leakage. To prevent the drain hose from coming off or leaking, it must be installed per the following instructions.

IMPORTANT: To ensure proper installation, this procedure must be followed exactly.

1. Check the drain hose to see that it is the proper length.
2. Wet the inside of the straight end of the drain hose with tap water. **IMPORTANT:** Do not use any lubricant other than water.

- Squeeze the ears of the silver, double-wire clamp with pliers to open it. Place the clamp over the straight end of the drain hose 1/4" (6 mm) from the end.

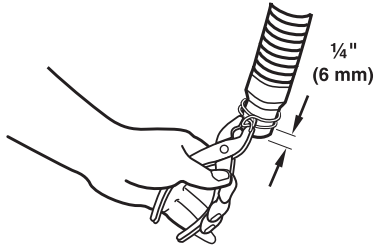

- Open the clamp and twist the hose back and forth while pushing down onto the drain connector at the bottom of the washer. Continue until the hose contacts the cabinet.

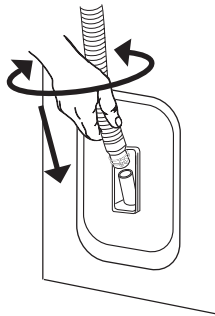

- Place the clamp over the area marked "CLAMP," and release the clamp.

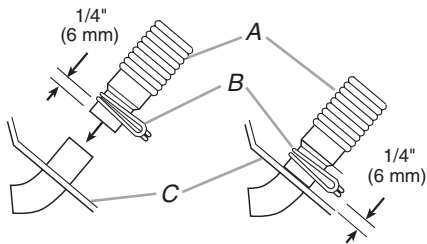

A. Drain hose
B. Clamp
C. Cabinet

For standpipe or laundry tub drain systems

- Open the yellow, single-wire clamp with pliers, and slide it over the hooked end of the drain hose to secure the rubber and corrugated sections together.

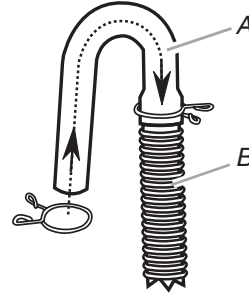

A. Hooked end
B. Drain hose

- Place the hooked end of drain hose into the laundry tub, or standpipe. Rotate the hook to eliminate kinks.

To prevent drain water from going back into the washer:

- Do not straighten the hooked end of drain hose.
- Do not force excess drain hose into the standpipe. The hose should be secure, but loose enough to provide a gap for air.
- Do not lay excess drain hose in the bottom of the laundry tub.

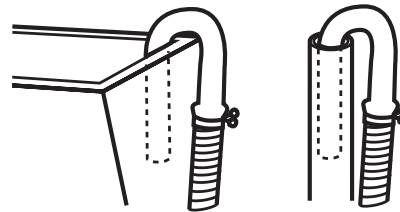

- For floor drain installation, see kit number required under "Alternate Parts" on page 2-2.

CONNECT THE INLET HOSES

1. Insert the new flat washers (supplied) into each end of the inlet hoses. Firmly seat the washers in the couplings.

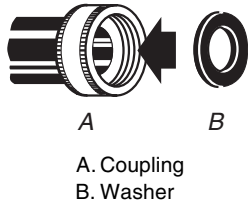

2. Make sure the washer basket is empty.
3. Attach the hose with the red coupling to the hot water faucet. Screw the coupling on by hand until it is seated on the washer.
4. Attach the hose with the blue coupling to the cold water faucet. Screw the coupling on by hand until it is seated on the washer.
5. Using pliers, tighten the couplings an additional two-thirds turn. **NOTE:** Do not overtighten the couplings, or damage to the valves may result.

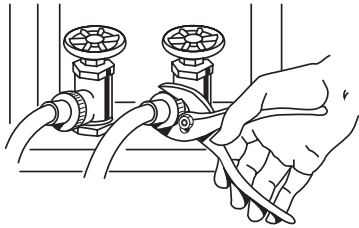

6. Run water through both faucets and inlet hoses, into a bucket or laundry tub, to get rid of particles in the water lines that might clog the inlet valve screens.

7. Attach the hose with the red coupling to the HOT (right) inlet valve. Attaching the red coupling first makes it easier to tighten connection with pliers. Screw the coupling on by hand until it is seated on the washer. Using pliers, tighten the couplings with an additional two-thirds turn. **NOTE:** Do not overtighten the couplings, or damage to the valves may result.

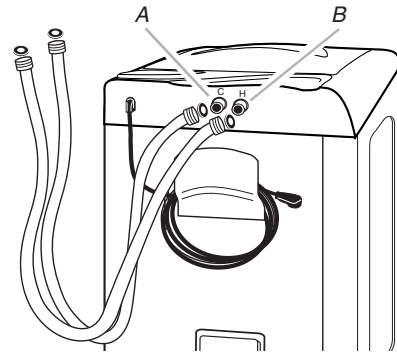

8. Attach the hose with the blue coupling to the COLD water (left) inlet valve. Screw the coupling on by hand until it is seated on the washer. Using pliers, tighten the couplings with an additional two-thirds turn. **NOTE:** Do not overtighten the couplings, or damage to the valves may result.

- Turn on the water faucets and check for leaks. A small amount of water might enter the washer. You will drain this later.

NOTE: Replace inlet hoses after 5 years of use to reduce the risk of hose failure. Record the hose installation or replacement dates for future reference.

- If you connect only one water hose, you must cap off the remaining water inlet port.
- Periodically inspect and replace the hoses if bulges, kinks, cuts, wear, or leaks are found.

SECURE DRAIN HOSE

- Drrape the power cord over the console.
- Move the washer to its final location and remove any cardboard used to move washer.
- Locate the beaded tie strap (supplied).



Beaded Tie Strap

- Wrap the drain hose to the laundry tub leg or standpipe with the tie strap (see illustrations A and B).

If the washer faucets and the drain standpipe are recessed, place the hooked end of the drain hose in the standpipe (see illustration C). Tightly wrap the tie strap around the water inlet hoses and the drain hose.

Do not force excess drain hose back into the rear of the washer.

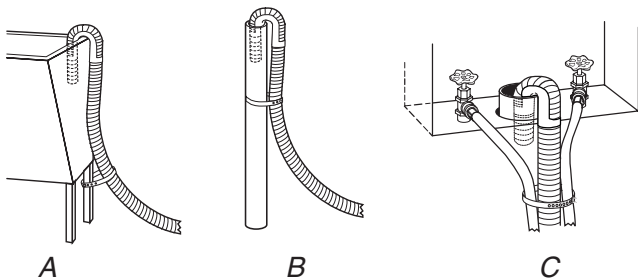

LEVEL THE WASHER

Properly leveling the washer will help prevent excessive noise and vibration. To level the washer:

- Move the washer to its final location.
- Check to see if the washer is level. Check from side-to-side and from front-to-back by lining up the level with the top edge of the washer cabinet where it meets the washer top.

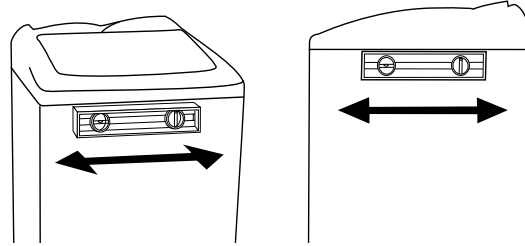

- If the washer is not level, prop up the front of the washer with the wood block and adjust the feet up or down as necessary. If the washer is against a wall, move the washer out slightly before tipping back. Repeat this step until washer is level.

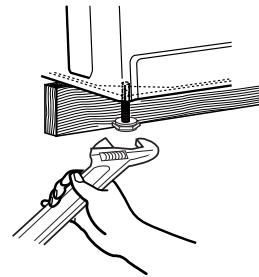

COMPLETE INSTALLATION

1. Check the electrical requirements on page 2-3, and make sure that you have the correct electrical supply and the recommended grounding method.
2. Check to be sure that all the parts are now installed. If there is an extra part, go back through the steps to see which step was skipped.
3. Check to be sure you have all of your tools.
4. Dispose or recycle all packaging materials. Keep the expanded foam plug for use if the washer should be transported.
5. Check to be sure the water faucets are on.
6. Check for leaks around faucets and inlet hoses.

⚠ WARNING



Electrical Shock Hazard

Plug into a grounded 3 prong outlet.

Do not remove ground prong.

Do not use an adapter.

Do not use an extension cord.

Failure to follow these instructions can result in death, fire, or electrical shock.

7. Plug into a grounded 3 prong outlet.
8. Read the "Washer Use."
9. To test the washer:
 - a) Measure and add 1/2 the normal recommended amount of detergent to the washer.
 - b) Close the lid.
 - c) Select any cycle, and then press the START/OFF keypad.
 - d) Allow the washer to complete one whole cycle.

PORTABLE INSTALLATION INSTRUCTIONS

DRAIN SYSTEM

The washer must drain into a sink or laundry tub with a carry-away capacity of 7 gallons (26.6 L) per minute. The top of the tub must be at least 27" (68.6 cm) above floor, and no higher than 48" (121.9 cm) from the bottom of the washer.

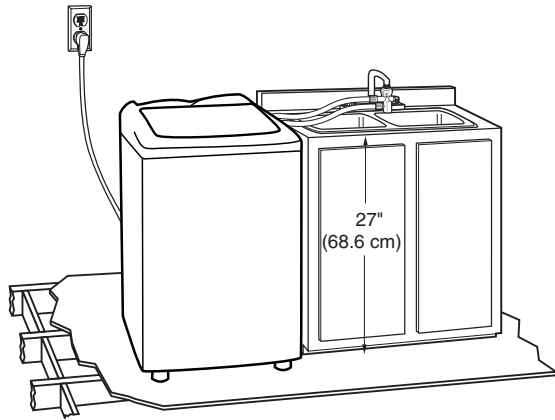

CONNECT FILL-AND-DRAIN HOSE

Proper connection of the fill-and-drain hose will protect your floors from damage due to water leakage. To connect the hoses:

Connect Fill Hose

Attach the fill-and-drain hose to the cold water (left) inlet valve. Tighten coupling by hand. Use pliers to make an additional two-thirds turn. **NOTE:** Do not overtighten the couplings, or damage to the valves may result.

The hot water (right) inlet valve is capped. Leave this valve capped.

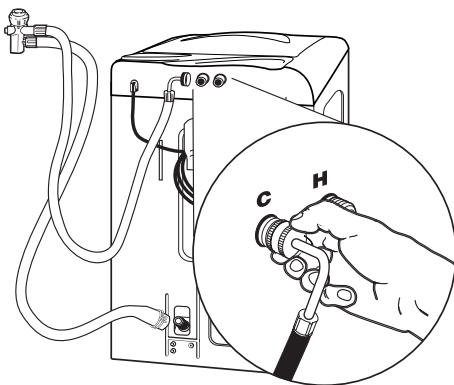

Connect Drain Hose

To prevent the fill-and-drain hose from leaking, it must be installed per the following instructions.

IMPORTANT: To ensure proper installation, this procedure must be followed exactly.

1. Wet the inside end of the fill-and-drain hose with tap water. **IMPORTANT:** Do not use any lubricant other than water.
2. Squeeze the ears of the silver, double-wire clamp with pliers to open the clamp.
3. Place the clamp over the straight end of the drain hose so it is 1/4" (6 mm) from the end.

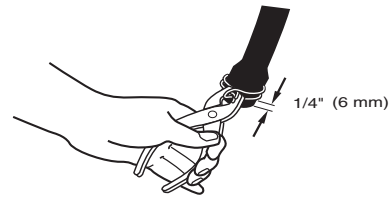

4. Open the clamp. Twist the hose back and forth while pushing down onto drain connector at the bottom of the washer. Continue until hose contacts the cabinet.

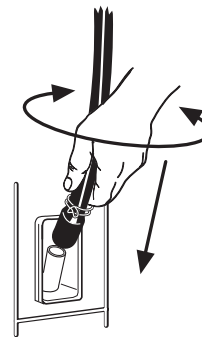

5. Place the clamp over the area marked "CLAMP," and release it.

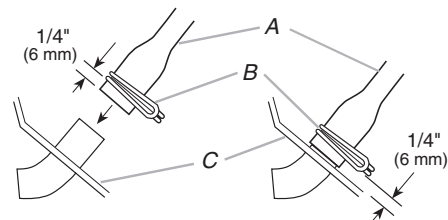

A. Drain hose
B. Clamp
C. Cabinet

ATTACH THE FAUCET ADAPTER KIT

Proper connection of your faucet adapter kit will allow hot and cold water to enter your washer properly. It also helps prevent water damage due to leaks.

Attach the faucet adapter kit from the parts bag to your faucet. A standard faucet adapter and washer are supplied. Customized adapters are available from traditional plumbing supply sources.

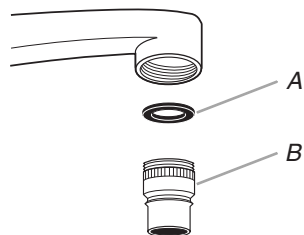

A. Washer
B. Adapter

CONNECT WASHER

1. Roll the washer to the sink area. The wheels do not roll from side to side. Be sure your washer is on a level floor to help avoid movement during the spin cycle.
2. Attach the fill-and-drain hose connector to a single-spout hot-cold water faucet. Move the locking collar down while lifting the connector until it snaps into place.

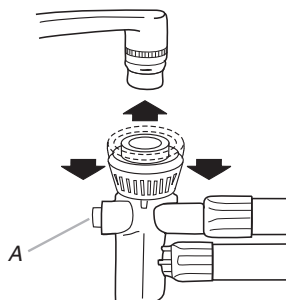

A. Red water-flow button

3. Set the water temperature for the wash cycle by adjusting the hot and cold water faucets.

To test the water, press the red water-flow button on the hose connector. You may need to adjust the water temperature for the rinse cycle. Keep the Wash/Rinse Temperature setting on your washer set at Cold/Cold.

COMPLETE INSTALLATION

1. Check the electrical requirements on page 2-3, and make sure that you have the correct electrical supply and the recommended grounding method.
2. Check to be sure that all the parts are now installed. If there is an extra part, go back through the steps to see which step was skipped.
3. Check to be sure you have all of your tools.
4. Dispose or recycle all packaging materials.
5. Check to be sure the water faucets are on.
6. Check for leaks around faucets and inlet hoses.

NOTE: If the washer is attached to a faucet equipped with a spray hose, the constant water pressure may cause the spray hose to leak. To prevent a possible failure, the spray hose should be disconnected or replaced with a high-pressure hose.

⚠ WARNING



Electrical Shock Hazard

Plug into a grounded 3 prong outlet.

Do not remove ground prong.

Do not use an adapter.

Do not use an extension cord.

Failure to follow these instructions can result in death, fire, or electrical shock.

7. Plug into a grounded 3 prong outlet.
8. Read the "Washer Use."

9. To test the washer:
 - a) Measure and add 1/2 the normal recommended amount of detergent to the washer.
 - b) Close the lid.
 - c) Select any cycle, and then press the START/OFF keypad.
 - d) Allow the washer to complete one whole cycle.

DISCONNECT WASHER

Disconnect the portable washer after use and return it to the storage area.

1. Turn off the water faucets.
2. Unplug the power cord.
3. Press the red water-flow button to release water pressure in the hose. Pull the locking collar down to remove the connector from the faucet.

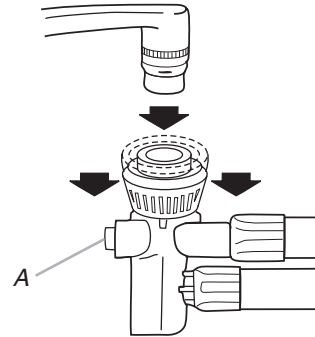

A. Red water-flow button

4. Pour water out of the faucet connector. Place fill-and-drain hose on the plastic holder in the back of the washer.

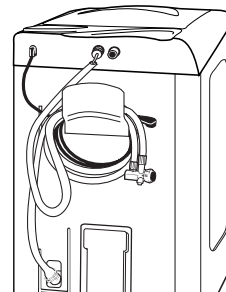

PRODUCT OPERATION

THEORY OF OPERATION

SUB-INTERVAL SPIN (S.I.S.)

Sub-Interval Spin (S.I.S.) is a series of short spin times initiated by the drive motor during the first 120 seconds of the cotton/regular spin cycles, and throughout all of the permanent press and delicate spin cycles.

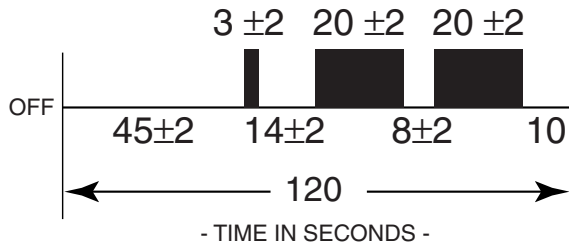

The S.I.S. is designed to help the washer break up soap suds for easier water removal during drain. The washer uses the drive motor for the sub-interval spin, (instead of using a clutch), to bring the basket up to its full spin speed.

THE SPLUTCH ASSEMBLY

The splutch slider has teeth around the bottom hub that mate with the teeth in the pulley. The engaging and disengaging of these teeth changes the drive motor from operating the agitator or spinning the tub (see the illustration to the right).

The hub of the slider is grooved to fit over the lower splined end of the spin tube on the gearcase assembly. The upper portion of the spin tube is connected directly to the basket. As long as the slider is engaged with the splutch pulley the basket will rotate.

The cam ring controls the movement of the slider up or down. As the cam ring rotates, the tabs on the bottom slide up and down on mating tabs in the splutch housing. This up and down movement of the cam ring controls the movement of the slider. A spring maintains pressure between the two sets of tabs.

The rotation of the cam ring is controlled by the brake solenoid and the brake arm assembly. This assembly also has a brake band which is wrapped around a rotor on the end of the spin tube. When the solenoid is energized:

- The brake arm rotates to loosen the brake band around the rotor.
- The cam ring rotates to lower the slider.

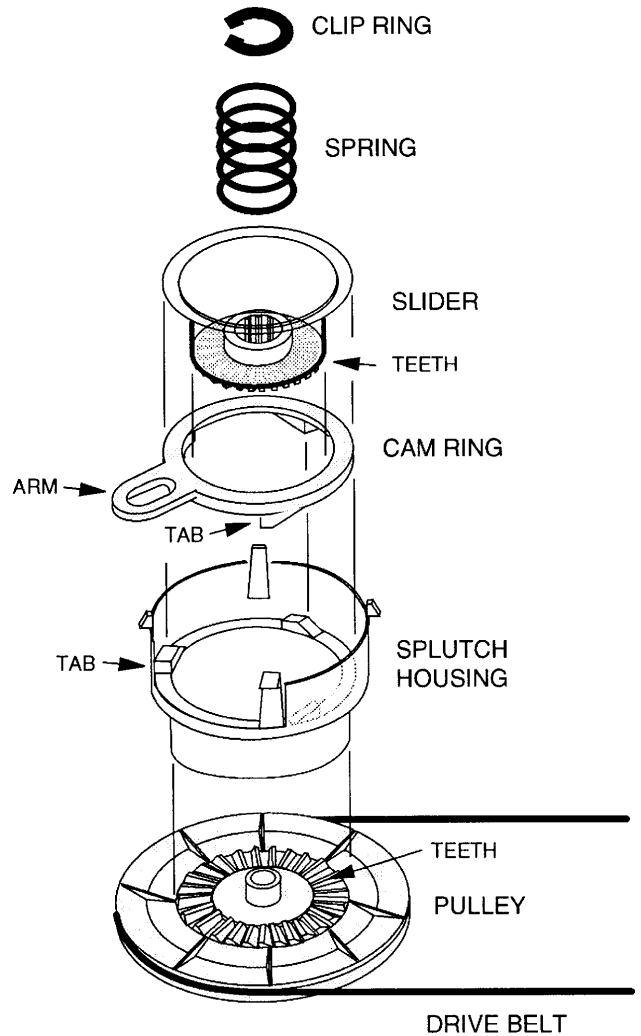

The Splutch Assembly During Wash/Agitate

When a Wash/Agitate cycle occurs, the agitator which is connected to the shaft inside the spin tube, is rotated by the drive motor and the splutch pulley. At this time the brake actuator is not energized. This leaves the slider disengaged from the pulley and the brake band in tight against the rotor. This keeps the spin tube from moving (see illustration A).

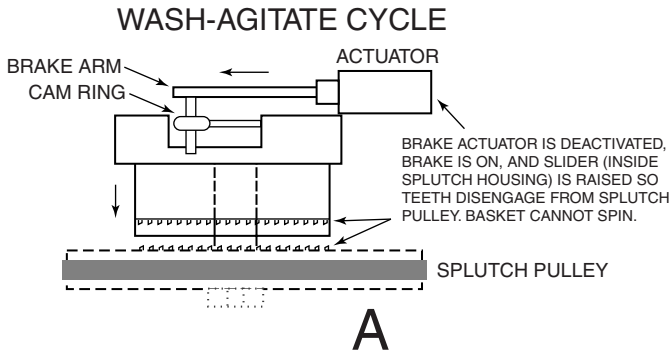

The Splutch Assembly During Spin

When a Spin cycle occurs, the brake actuator is energized causing the slider to drop onto the pulley teeth. The brake band is loosened from around the rotor releasing the spin tube. The basket and agitator can now be directly driven by the drive motor and spin (see illustration B).

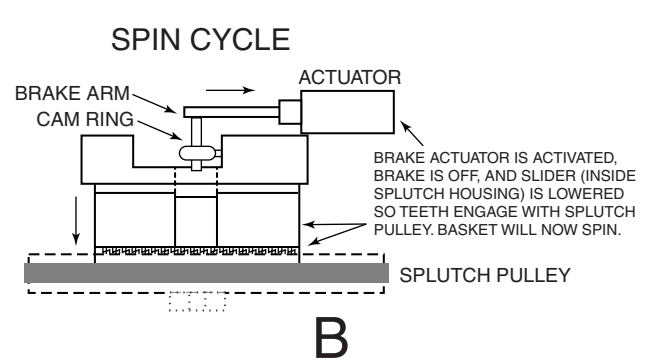

THE GEARCASE ASSEMBLY

The gearcase has two separate shafts, one inside the other. The inner shaft is splined and is driven by the drive motor through the splutch pulley and drive belt. The agitator slides over the top of the splined inner shaft and rotates when the drive motor operates.

The outer shaft or spin tube is connected to the rotor and operates independently of the inner shaft. Four planetary gears located inside the gearcase reduce the speed of the spin tube to a 5:1 ratio. These gears are driven by a central gear connected to a shaft emerging from the splutch assembly.

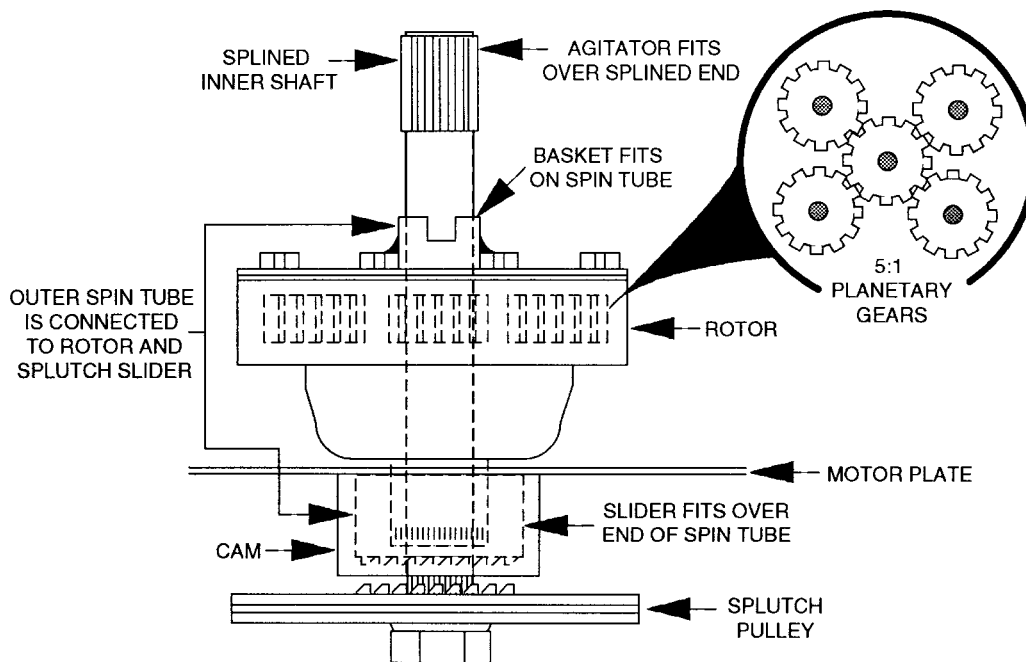

WASHER USE

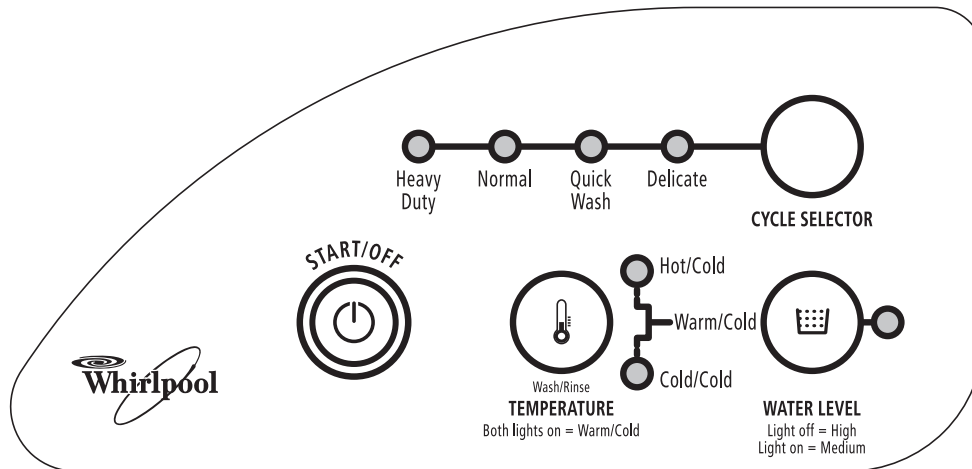

STARTING THE WASHER

⚠️ WARNING

Fire Hazard

Never place items in the washer that are dampened with gasoline or other flammable fluids.

No washer can completely remove oil. Do not dry anything that has ever had any type of oil on it (including cooking oils).

Doing so can result in death, explosion, or fire.

WARNING: To reduce the risk of fire, electric shock, or injury to persons, read the IMPORTANT SAFETY INSTRUCTIONS in the "Use & Care Guide" before operating this appliance.

The following is a guide to starting your washer. Periodic references to other sections in the "Use & Care Guide" provide more detailed information.

1. Add measured detergent. Add liquid detergent to the bottom of the washer or powdered detergent to the detergent dispenser drawer.

NOTE: If desired, powdered color-safe bleach can be added to the detergent dispenser with the powdered detergent. Liquid color-safe bleach should be added to the bottom of the washer basket.

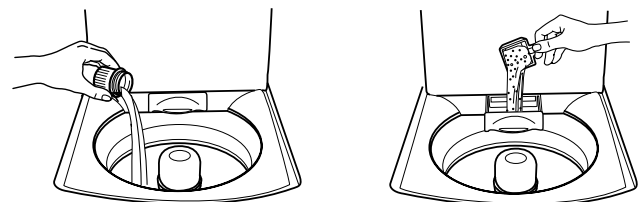

2. Drop a sorted load of clothes loosely into your washer.
 - Load evenly to maintain washer balance. Mix large and small items.
 - Items should move easily through the wash water. Overloading can cause poor cleaning.
 - To reduce wrinkling of permanent press clothes and some synthetic knits, use the large load water level setting to provide more space (see step 6).

3. **Optional:** Pour measured liquid chlorine bleach into the liquid chlorine bleach dispenser. Bleach will be dispensed automatically during the wash part of the cycle.

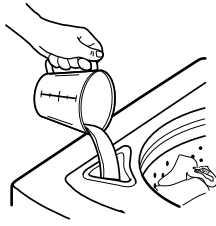

- Never use more than 1 cup (250 mL) for a full load. Use less for a smaller load size.
 - Follow the manufacturer's directions for safe use.
 - To avoid spilling, use a cup with a pouring spout. Do not let bleach splash, drip, or run down into the washer basket.
 - Use only liquid chlorine bleach in this dispenser.
4. **Optional:** Pour measured liquid fabric softener into the liquid fabric softener dispenser. Softener is added automatically during the rinse portion of the cycle.



Dilute liquid fabric softener by filling the dispenser with warm water until liquid reaches the bottom of the opening of the dispenser.

- Do not spill or drip any fabric softener on the clothes.
- Use only liquid fabric softener in this dispenser.

5. Close the washer lid. Washer will not fill, agitate or spin with the lid open.
6. Press the WATER LEVEL button to select the correct setting for your wash load and the type of fabric being washed. For a medium load the indicator light is on, for a large load the light is off.
 - Choose a water level that allows the load to move freely for best fabric care.
 - You may change the water level setting while the washer is filling. If you change from high to medium but the water has filled past medium, you will get medium with the next fill.
7. Set the water temperature for the type of fabric and soils being washed. Use the warmest wash water safe for fabric. Follow garment label instructions.

For Portable Installations

Wash and rinse water temperatures are set at your faucet. The Wash/Rinse Temperature control does not set temperature.

Adjust the Hot and Cold water faucets to desired wash temperature. Keep the Wash/Rinse Temperature control set at COLD/COLD.

NOTE: The Cold/Cold setting allows water from the faucet to enter the washer, but does not control the incoming water temperature.

- For a rinse temperature that is different from the wash temperature, you must adjust the water temperature at the faucet after the washer has completed its initial fill.
- To test the water temperature, press the red water-flow button on the hose connector.

For Permanent Installations

Press the WASH/RINSE TEMPERATURE button to set the wash temperature. For a Hot wash the top light is on, for Cold the bottom light is on, for Warm both lights are on. All cycles use a cold rinse.

Selecting Water Temperatures

Water Temp	Use For
Hot	Whites and pastels Heavy soils
Warm	Bright colors Moderate to light soils
Cold	Colors that bleed or fade Light soils

NOTE: In wash water temperatures colder than 70°F (21°C), detergents do not dissolve well. Soils can be difficult to remove. Some fabrics can retain wear wrinkles and have increased pilling (the formation of small lint-like balls on the surface of garments).

- Press the CYCLE SELECTOR button to select the wash cycle you want. See “Cycles.”
- Press the START/OFF keypad.

To stop or restart your washer

- To stop the washer at any time, lift the lid, cycle will pause.
- To restart the washer, close the lid, cycle will resume.

CYCLES

This section describes the available wash cycles and will help you make the best cycle selections for your wash loads. Each cycle is designed for different types of fabric and soil levels.

- The washer pauses briefly throughout each cycle. These pauses are normal. Refer to “Normal Sounds” to learn more about the sounds you may hear during a wash cycle.
- Refer to “Understanding Washer Cycles” to learn what happens during a wash cycle.

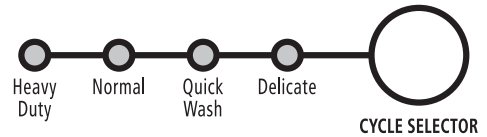

Heavy Duty

Use this cycle to get 16 minutes of wash time for sturdy or heavily soiled loads. Wash combines high-speed agitation and high-speed spin for maximum soil removal.

Normal

Use this cycle to get 12 minutes of wash time for normally soiled cottons and linens. Wash combines medium-speed agitation and high-speed spin to shorten drying time.

Quick Wash

Use this cycle to get 6 minutes of wash time. Use for small loads of lightly soiled items that you need in a hurry. Wash combines high-speed agitation and high-speed spin to shorten drying time.









Delicate

Use this cycle to get 8 minutes of wash time for lingerie and loosely knit items. Wash combines low-speed agitation for gentle soil removal, and high-speed spin to shorten drying time.

UNDERSTANDING WASHER CYCLES

When a cycle is selected, the washer lid is closed, and Start is pushed, the washer fills (to the selected load size) before agitation and timing start. The lid must be closed during operation. The washer will not fill, agitate or spin with the lid open.

NOTE: The washer pauses briefly throughout each cycle. These pauses are normal for washer operation.

WASH	RINSE
 1. Fill	 1. Fill
 2. Wash selected time	 2. Rinse
 3. Drain No agitation	 3. Drain No agitation
 4. Spin	 4. Spin
	 5. Off

NORMAL SOUNDS

Your new washer may make sounds your old one didn't. Because the sounds might be unfamiliar, you may be concerned about them. These sounds are normal.

During Drain

If water is drained quickly from your washer (depending on your installation), you may hear air being pulled through the pump during the end of draining.

After Drain And Before Spin

When the cycle changes from draining to spinning, you may hear gears engaging.

COMPONENT ACCESS

This section instructs you on how to service each component inside the Whirlpool 22" Compact Automatic Washer. The components and their locations are shown below.

COMPONENT LOCATIONS



Viewed From Bottom Of Top Cover

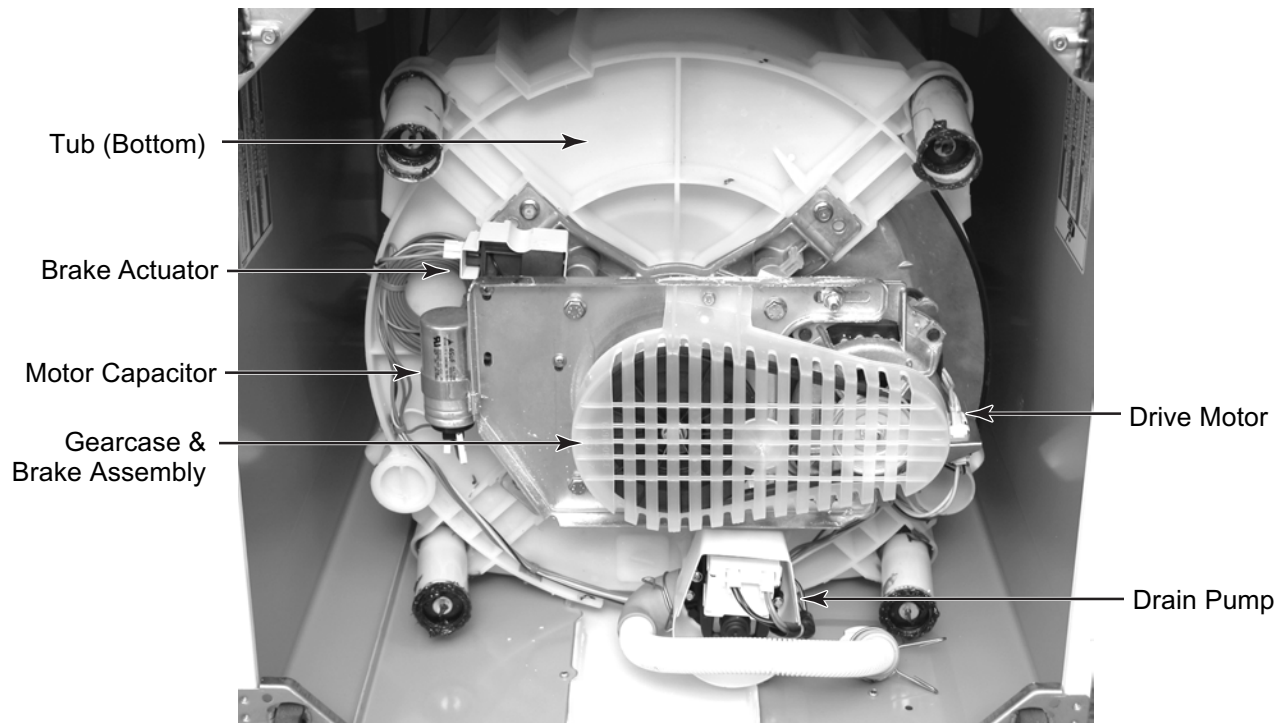

Viewed From Bottom Of Cabinet

REMOVING THE PRESSURE SWITCH, WATER INLET VALVES, LID SWITCH, INTERFACE AND ELECTRONIC CONTROL BOARDS

!WARNING



Electrical Shock Hazard
Disconnect power before servicing.
Replace all parts and panels before
operating.
Failure to do so can result in death or
electrical shock.

1. Unplug washer or disconnect power.
2. Turn off the water supply to the washer.
3. Tape the lid of the washer closed so it does not open when you handle the top cover in the following steps.
4. Pull the washer away from the wall so you can access the rear of the unit.
5. Remove the two 5/16" hex-head machine screws from the back of the top cover.



Top Cover Screws

6. Lift the rear of the top cover and push it forward to unhook it from the front.



7. Rotate the front of the top cover up, and rest it against a wall.



8. Remove the two 7/32" hex-head screws from the component cover.
9. Using a putty knife, pry up on the cover and release the four tabs of the component cover from the top cover. Rotate the cover down so that it lays on the top of the cabinet.

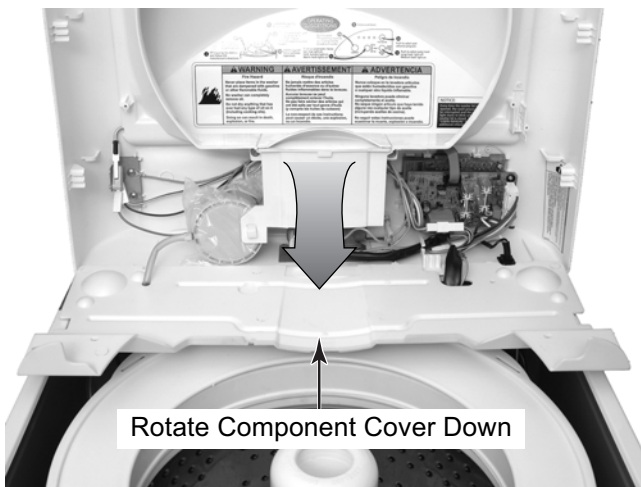
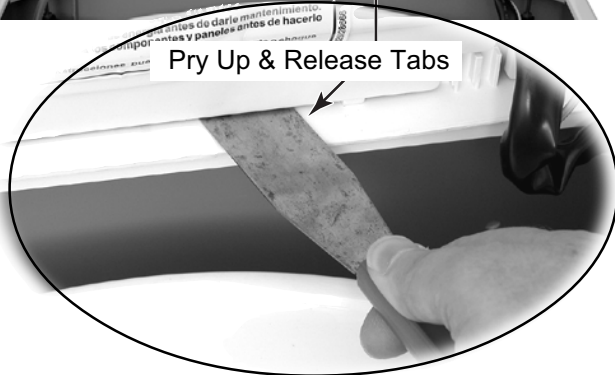
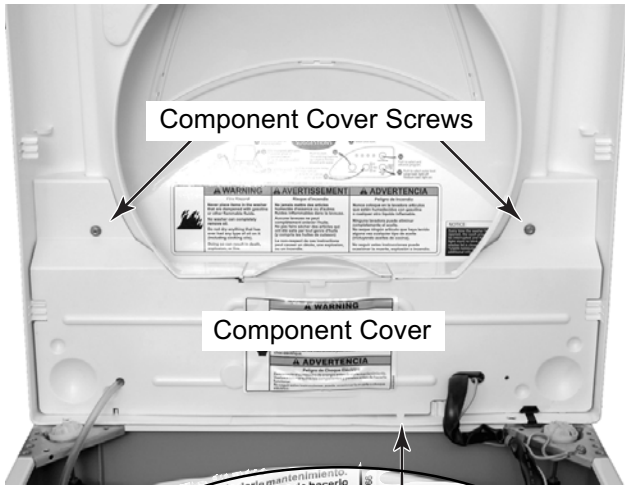

10. **To remove the pressure switch:**

- a) Squeeze the locking arms in, and push the pressure switch mounting tab out of the slot in the dispenser housing.

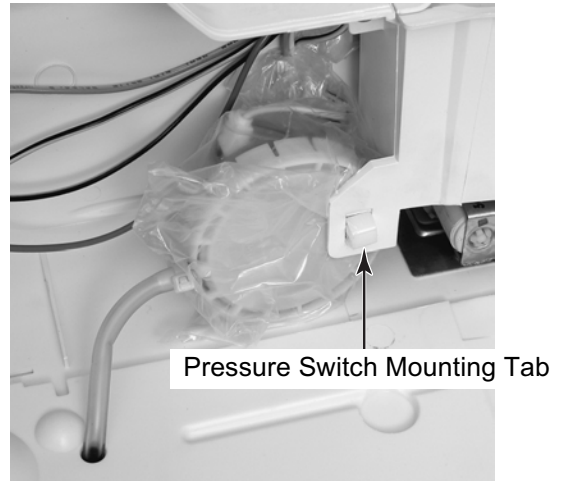

- b) Cut the wire tie from around the pressure switch hose and disconnect the hose and rubber o-ring from the pressure switch.
- c) Cut the wire tie from around the plastic bag and the pressure switch wires and remove the bag from the switch.

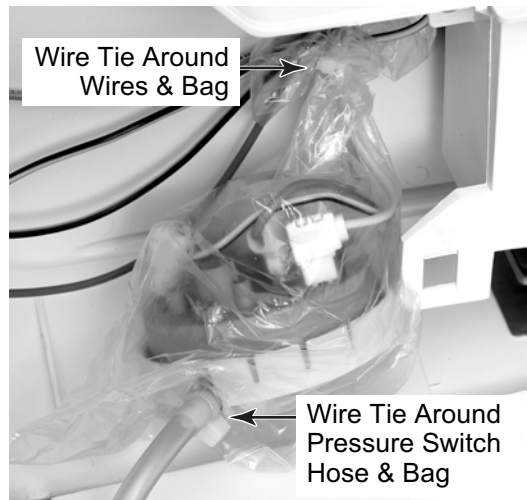

Continued on the next page.

- d) Disconnect the wire connectors from the pressure switch terminals.

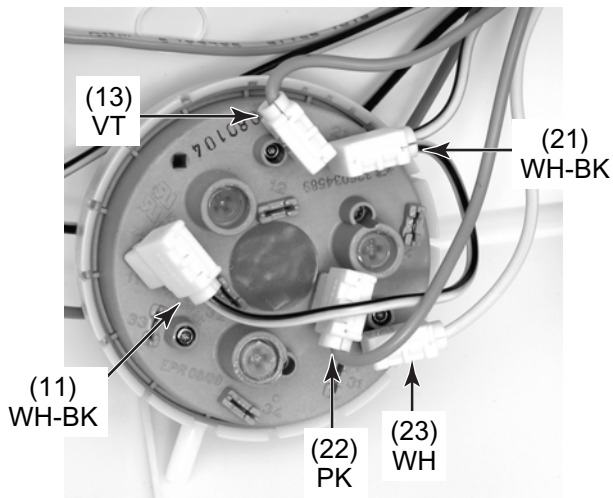

- d) Remove the dispenser housing and water inlet valves from the top cover and position the cover with the wire connectors facing you.
 e) Disconnect the wire connectors from the water inlet valve terminals.
 f) Disconnect the green ground wire from the water inlet valve bracket tab.

11. To remove the water inlet valves:

- a) At the rear of the top cover, remove the two 5/16" hex-head screws from the water inlet valves.

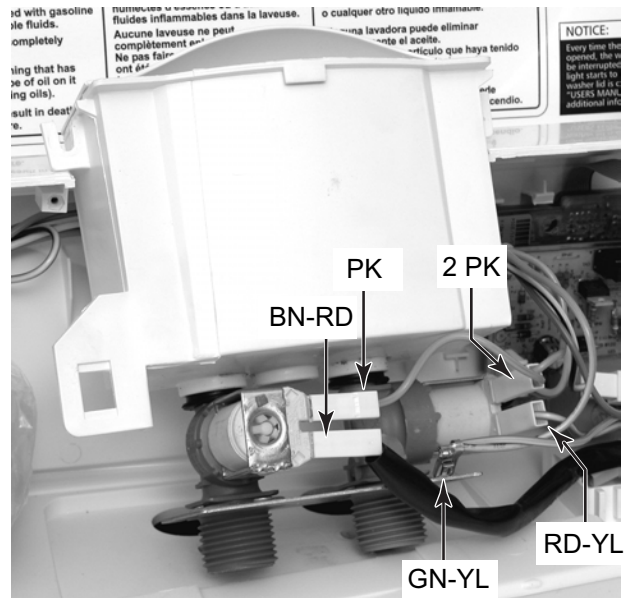

- b) Remove the pressure switch from the dispenser housing (see step 10a).
 c) Remove the two 7/32" hex-head screws from the dispenser housing.

⚠ WARNING

Electrical Shock Hazard
Connect green ground wire to ground terminal.
Failure to do so can result in death or electrical shock.

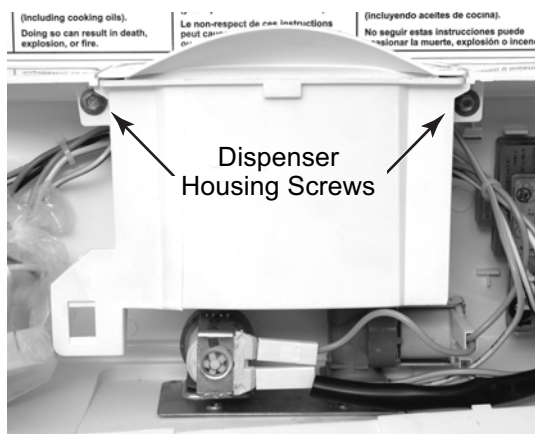

- g) Slide the water inlet valves out of their mounting bracket.

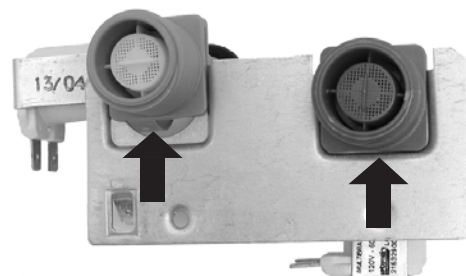

12. To remove the lid switch:

- a) Remove the two screws and the green ground wire from the lid switch bracket and remove the bracket and switch.

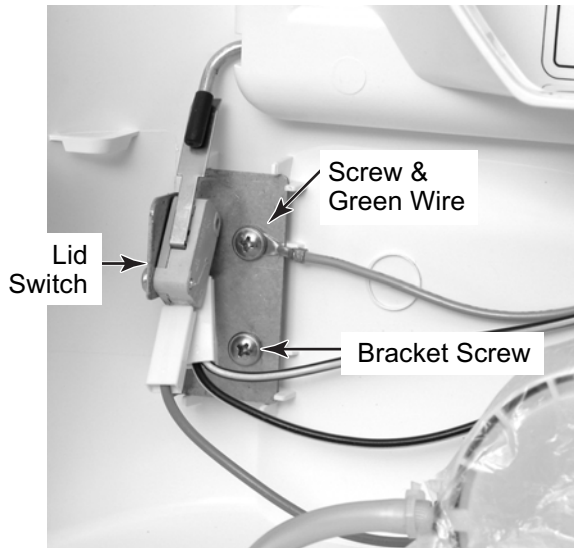

⚠ WARNING

Electrical Shock Hazard
Connect green ground wire to ground terminal.
Failure to do so can result in death or electrical shock.

- b) Remove the screw from the lid switch and remove the switch from the bracket.
- c) Disconnect the two wires from the lid switch terminals.

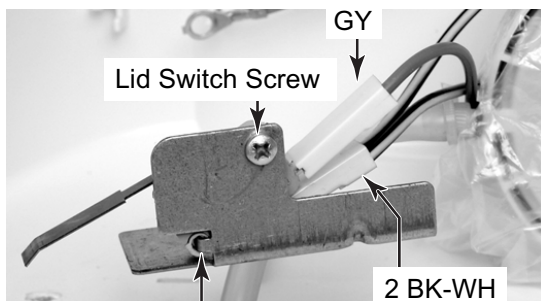

13. To remove the electronic control and interface boards:

- a) Remove the 5-wire, 3-wire, 2-wire, and ribbon cable connectors from the electronic control board.
- b) Remove the three screws from the electronic control board and remove the board.

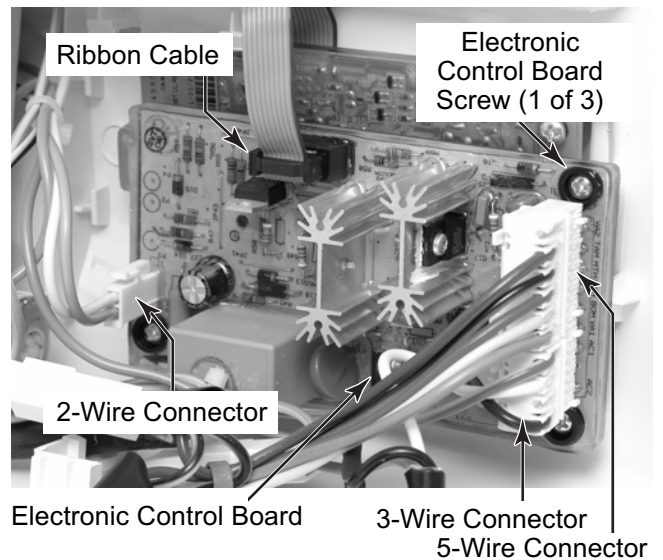

- c) Remove the three screws from the interface board and remove the board.

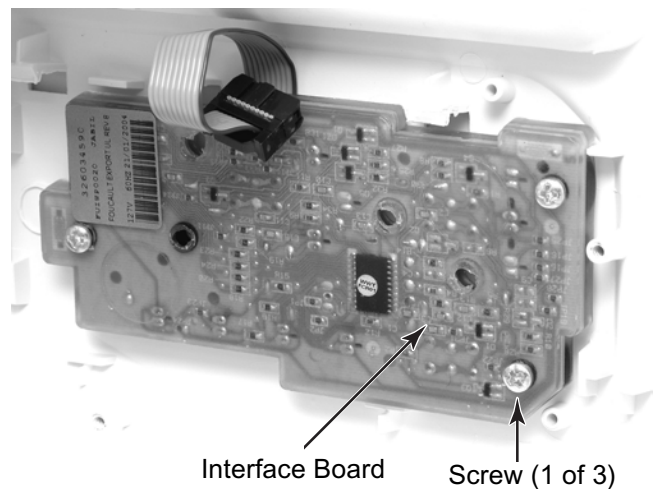

REMOVING THE BASKET

!WARNING



Electrical Shock Hazard

Disconnect power before servicing.

Replace all parts and panels before operating.

Failure to do so can result in death or electrical shock.

1. Unplug washer or disconnect power.
2. Turn off the water supply to the washer.
3. Remove the top cover from the washer and lean it back against a wall (see page 4-2 for the procedure).
4. Remove the 5/16" hex-head screw from the side of the agitator.

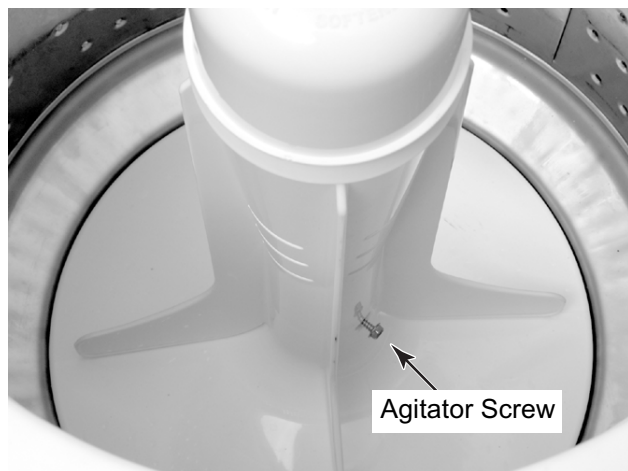

5. Pull up on the agitator and remove it from the drive shaft. **NOTE:** It may take some force to remove the agitator from the shaft.



6. Unsnap the tub ring at the four locations and remove the ring.

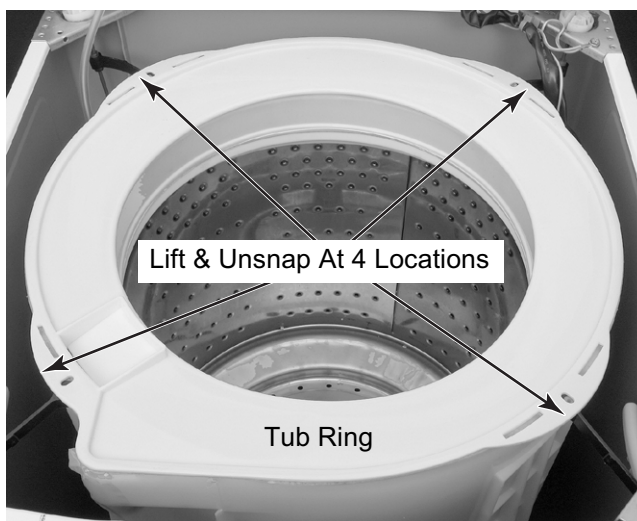

7. Loosen (do not remove) the wedge screw at the bottom of the basket.

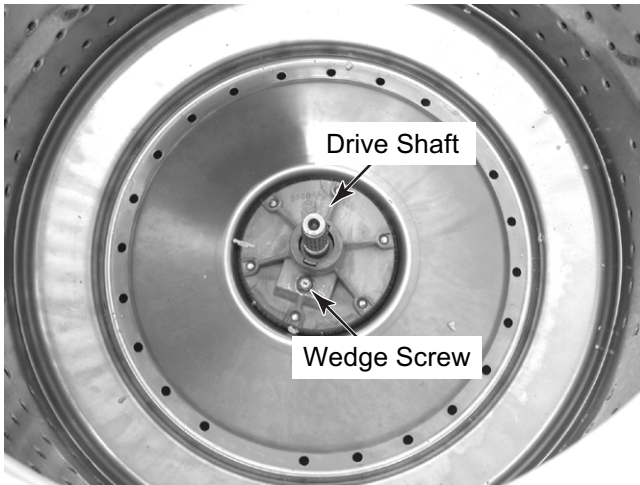

8. Pull the basket off the drive shaft and remove it from the tub.



9. To remove the balance ring from the basket, remove the four screws, and lift the ring off the basket.

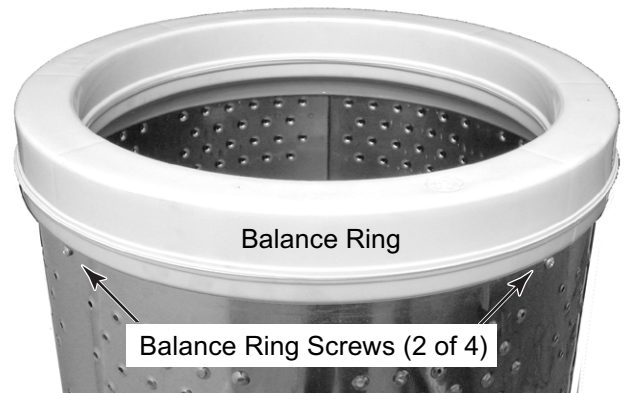

REASSEMBLY NOTE: When you reinstall the basket, be sure to align the tabs in the shaft with the slots in the basket, and press down firmly so that they are fully mated before tightening the wedge screw.

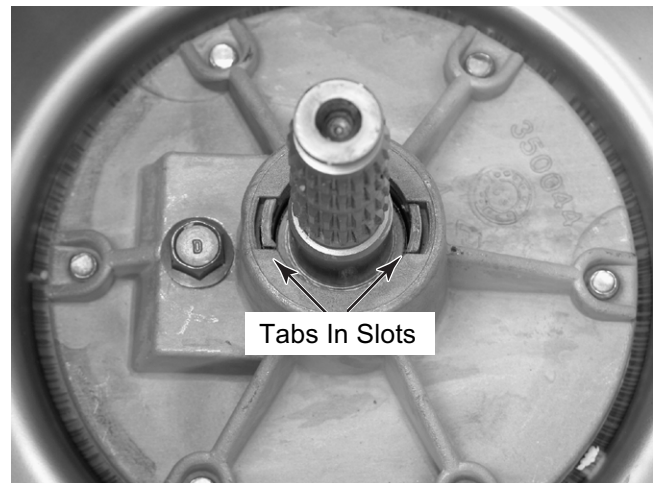

REMOVING THE TUB

!WARNING



Electrical Shock Hazard

Disconnect power before servicing.

Replace all parts and panels before operating.

Failure to do so can result in death or electrical shock.

1. Unplug washer or disconnect power.
2. Turn off the water supply to the washer.
3. Remove the top cover from the washer and lean it back against a wall (see page 4-2 for the procedure).
4. Remove the agitator and basket (see pages 4-6 and 4-7 for the procedures).
5. Reinstall the top cover on the washer and secure it with only one of the rear screws. You will remove the top cover again later.
6. Lay the washer on its rear panel so that you can access the bottom of the unit.

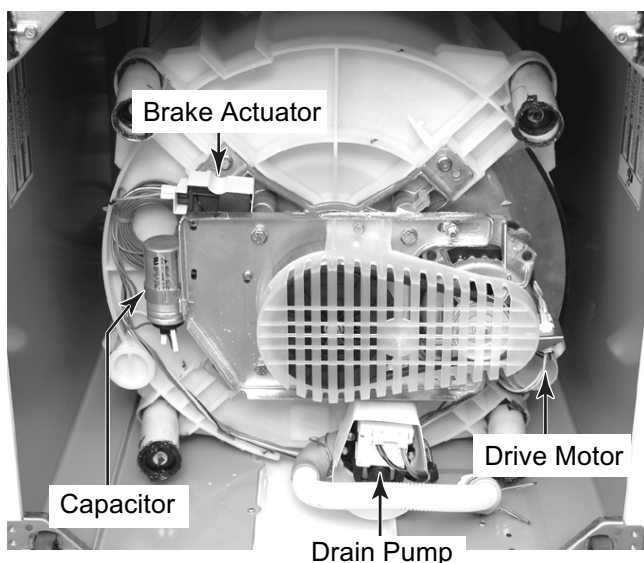

7. Remove the drain pump and hose from the tub (see steps 4 through 6 on page 4-18 for the procedure). **NOTE:** You can leave the end of the hose connected to the drain pump housing.
8. Disconnect the wire connectors from the following components (see the photo at the lower left for the component locations):
 - a) Brake actuator
 - b) Drive motor (and green ground wire)
 - c) Capacitor

!WARNING



Electrical Shock Hazard

Connect green ground wire to ground terminal.

Failure to do so can result in death or electrical shock.

9. Remove the five hex-head bolts from the tub support.

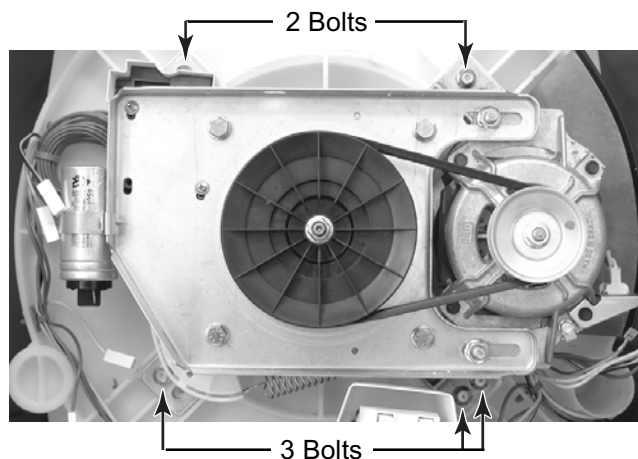

- Pull the tub support assembly straight forward until the rubber seal at the center of the tub opening is free, and set the assembly aside.

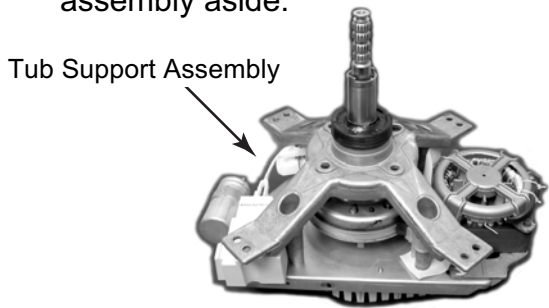

- Using pliers, press in on the locking tabs, and unsnap the five wire standoffs from the bottom of the tub. Make sure that all of the lower wiring is removed from the tub.
- Remove the two screws from the shield and remove the shield from the tub.

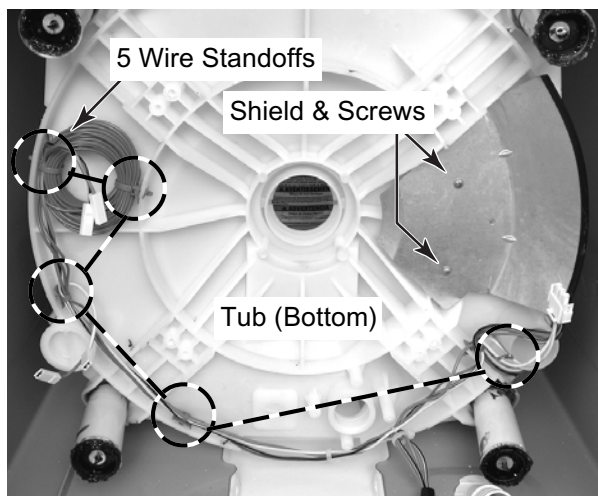

- OPTIONAL STEP:** To contain the grease on the suspension cups at the bottom of the tub, slide a plastic sandwich bag over each of the cups, and secure each with a rubber band.

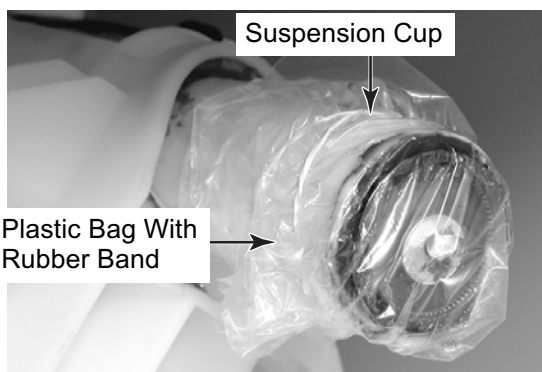

- Stand the washer in its upright position.

IMPORTANT: Place a plastic drop cloth under the cabinet to protect the floor covering.
- Remove the top cover and lean it back against a wall.
- Lift the rubber snubber straps off the four tub pins.

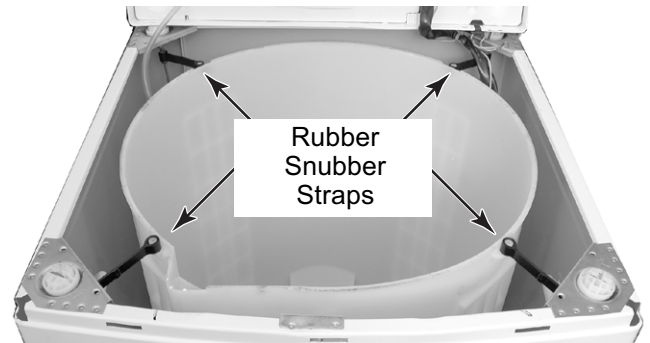

NOTE: Have a shop cloth ready to clean off any grease from your hands.

- Remove the four suspension rods from their suspension balls. To remove a rod:
 - Grasp the rod several inches below the suspension ball, then pry up with a small screwdriver, and unsnap the rod from the ball.

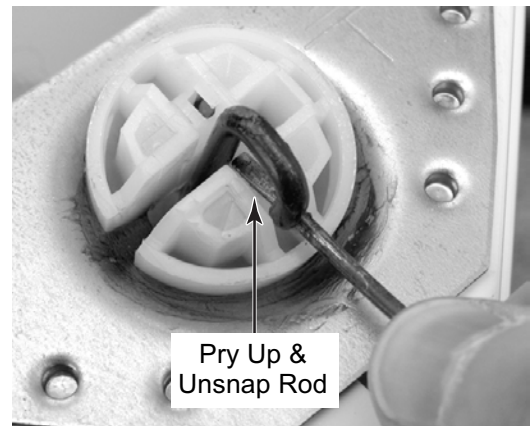

Continued on the next page.

- b) Turn the suspension ball so the bend in the rod is over the slot, and slide the rod through the slot and the hole in the cabinet gusset.

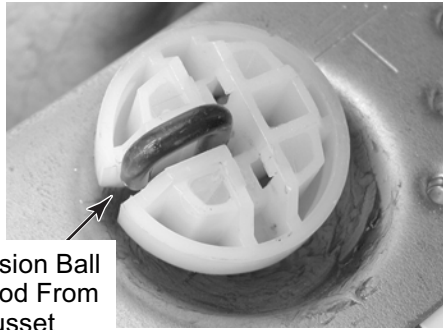

Turn Suspension Ball & Remove Rod From Slot & Gusset

- c) Hang the end of the rods over the edge of the tub, and tape them in place so they do not fall off.

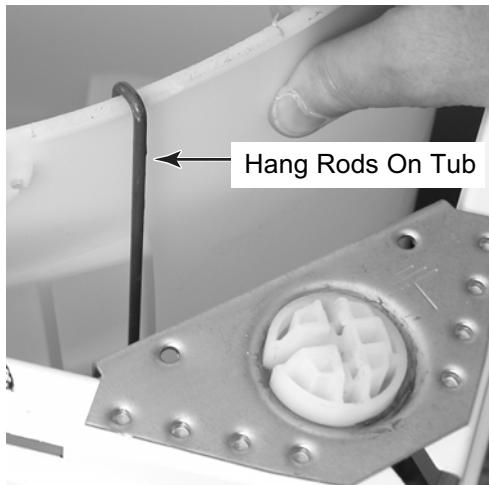

- b) Pressure switch hose (remove stand-offs & cut wire tie).

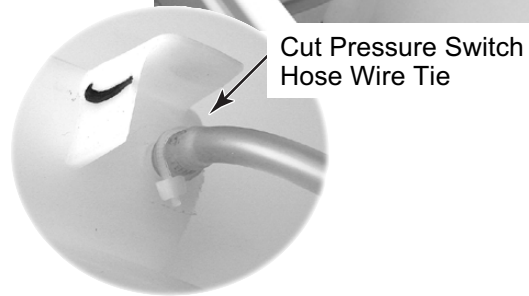
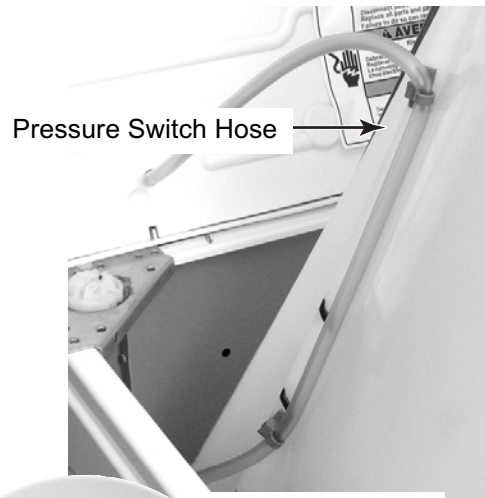

- c) Overflow hose (if present) and rubber seal.
- d) Four suspension rods and rubber snubber straps.

- 18. Partially lift the tub out of the washer cabinet and remove the following items from the sides of the tub:

- a) Wiring (remove standoffs).

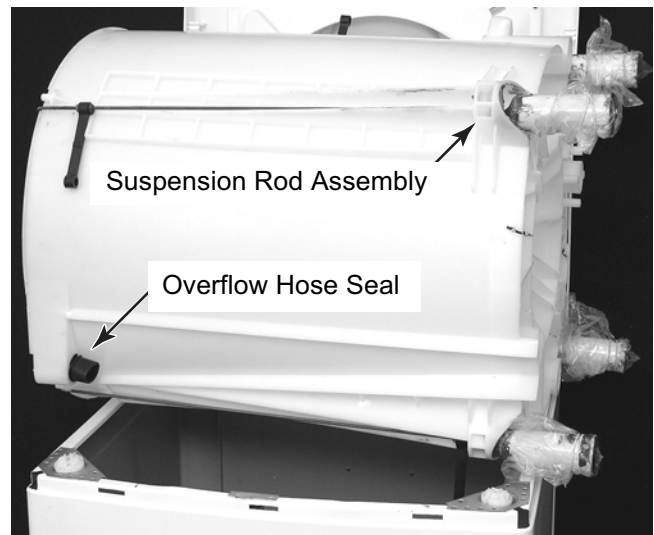

- 19. Remove the tub from the cabinet and place it on its side on a plastic drop cloth, then clean the excess grease off the tub.

REMOVING THE BRAKE AND GEARCASE ASSEMBLIES

⚠️ WARNING



Electrical Shock Hazard
Disconnect power before servicing.
Replace all parts and panels before operating.
Failure to do so can result in death or electrical shock.

1. Unplug washer or disconnect power.
2. Turn off the water supply to the washer.
3. Remove the agitator and basket (see pages 4-6 and 4-7 for the procedures).
4. Tape the lid closed and lay the washer on its rear panel so that you can access the bottom of the unit.
5. Remove the brake actuator and disconnect it from the brake arm (see pages 4-16 and 4-17 for the procedure).
6. Remove the two carriage bolts and nuts from the drive motor and remove the motor and the belt.
7. Press the locking arms and disconnect the wiring harness from the drive motor connector.
8. Remove the green ground wire from the motor ground terminal.

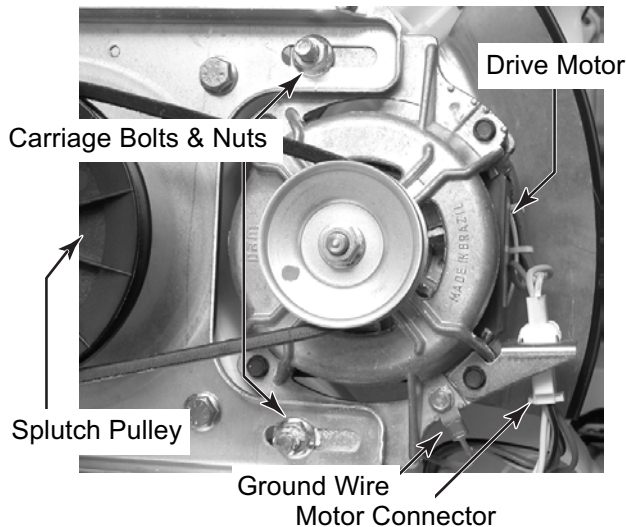

⚠️ WARNING



Electrical Shock Hazard
Connect green ground wire to ground terminal.
Failure to do so can result in death or electrical shock.

9. Remove the 1/2" hex-nut from the splutch pulley and remove the pulley.
10. Unsnap the cam splutch snap-in from the motor support and remove the snap-in.
11. Remove the four 1/2" hex-head bolts from the motor support.

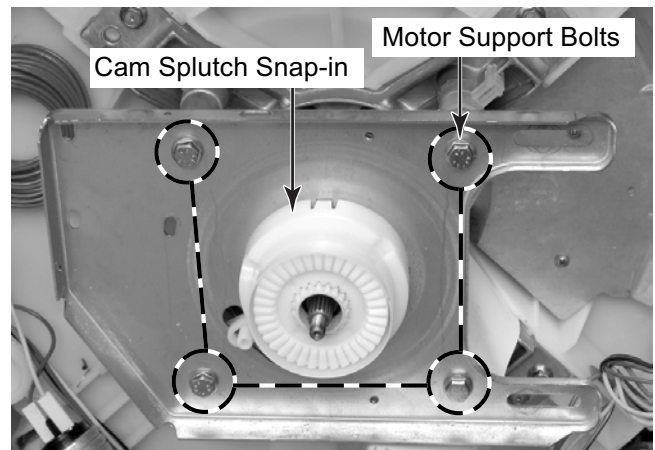

12. Remove the splutch spring, slider, and cam ring from the gearshaft.

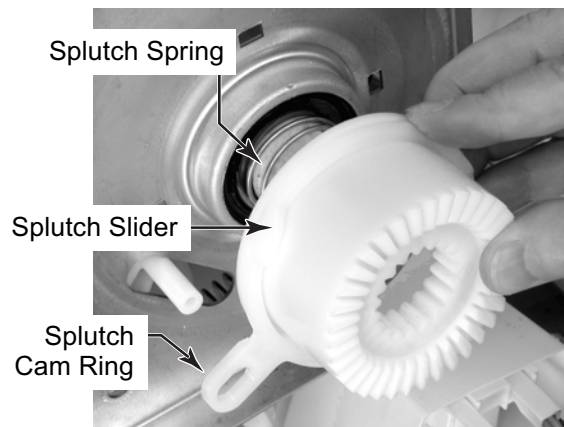

Continued on the next page.

13. Remove the clip from the groove in the gearshaft.

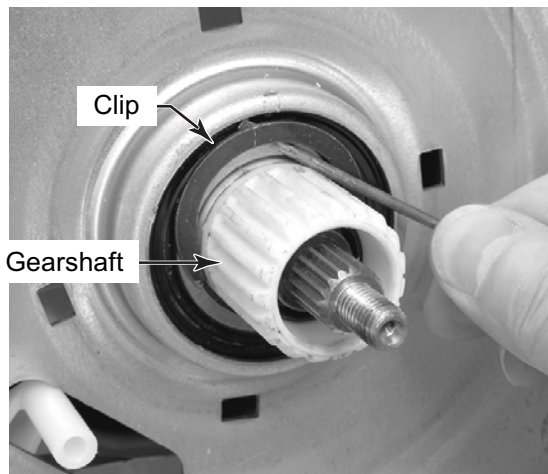

14. Pull the motor support off the gearshaft.

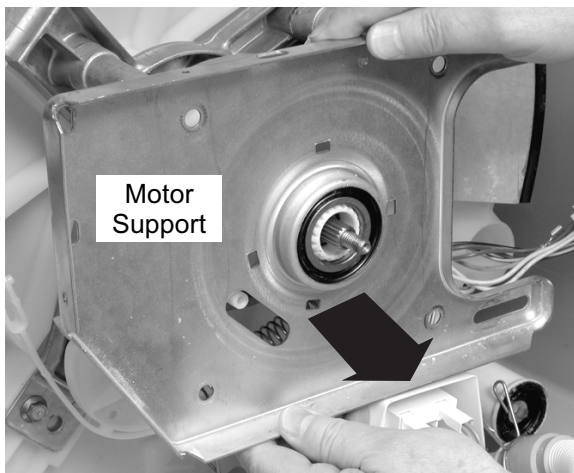

15. Remove the motor shield from the frame.

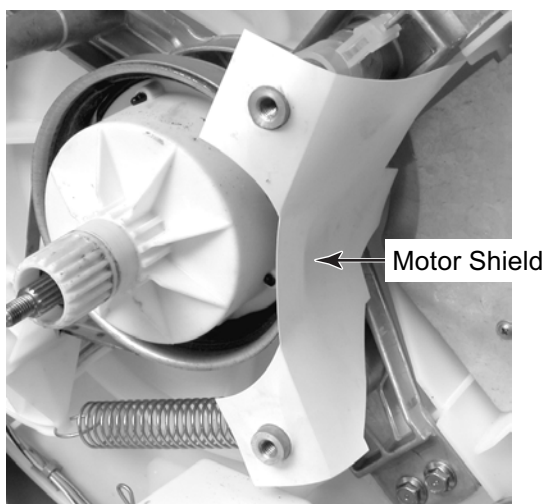

16. Pull the brake band support assembly off the frame post.

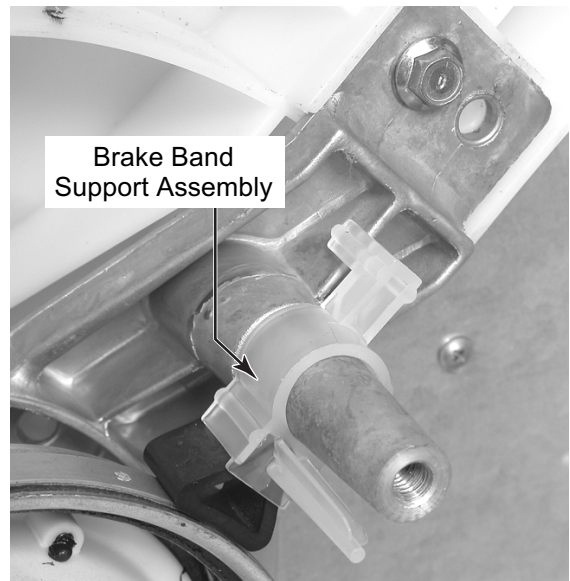

17. To remove the brake assembly:

- Pull the brake spring and slide the end off the tub support.
- Rotate the brake arm clockwise (CW) to fully expand (loosen) the brake band, then pull the band assembly, its spring, and the brake arm off the tub support.

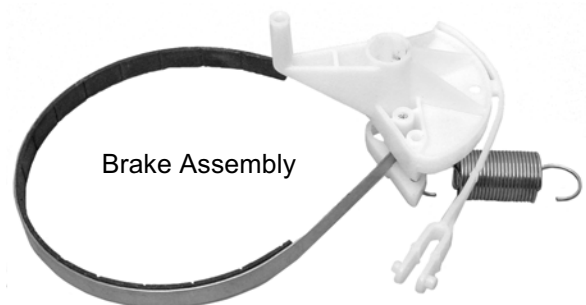
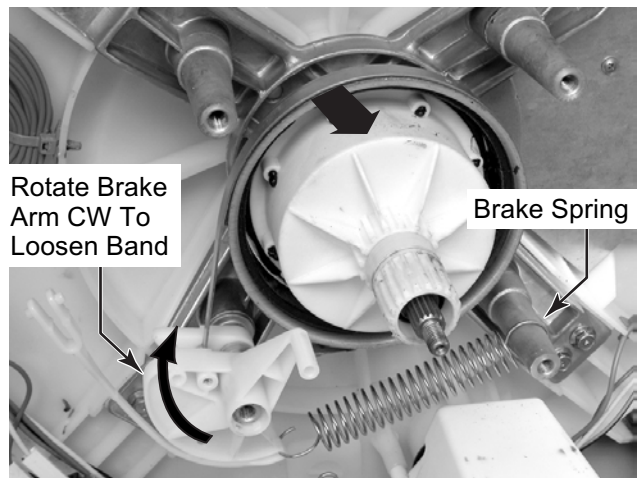

18. **To remove the gearcase assembly:**

- a) Remove the five hex-head bolts from the tub support.

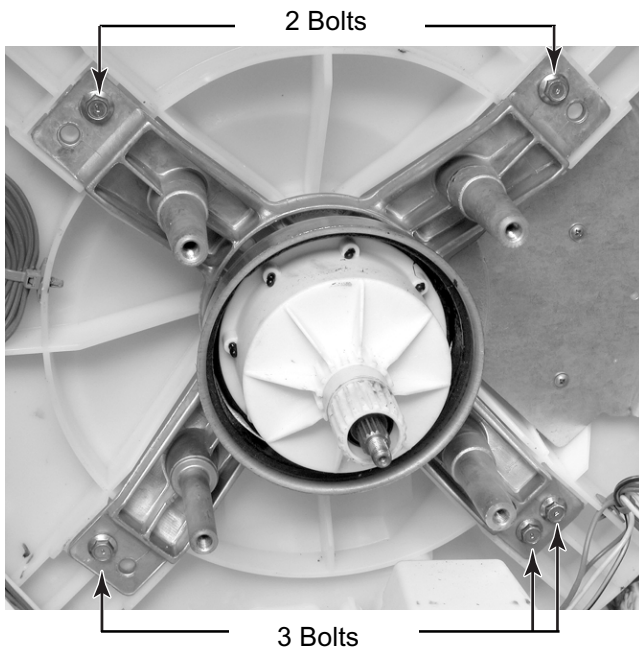

- b) Pull the gearcase and tub support from the tub.

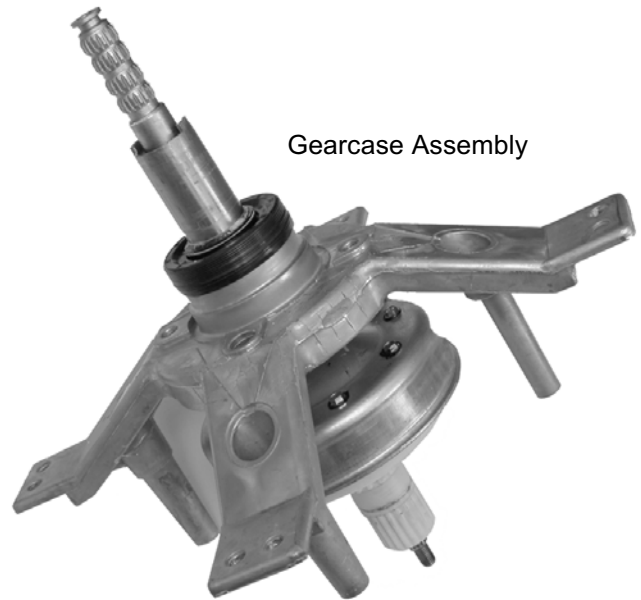

REMOVING THE CAPACITOR AND DRIVE MOTOR

!WARNING



Electrical Shock Hazard

Disconnect power before servicing.

Replace all parts and panels before operating.

Failure to do so can result in death or electrical shock.

1. Unplug washer or disconnect power.
2. Turn off the water supply to the washer.
3. Tape the lid closed and lay the washer on its rear panel so that you can access the bottom of the unit.

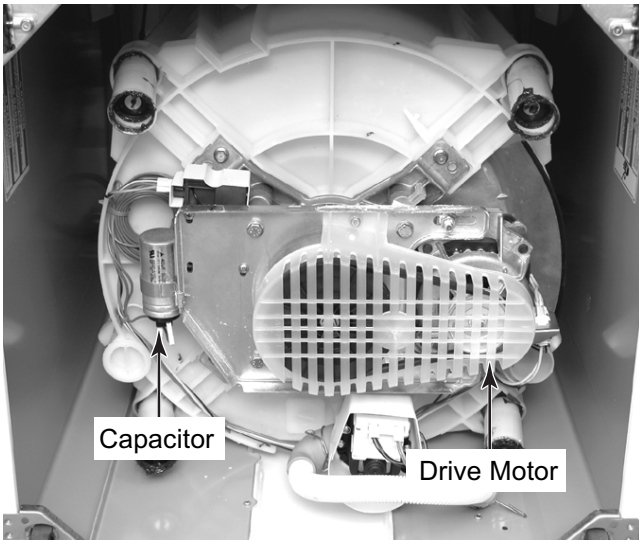

4. **To remove the capacitor:**
 - a) Without touching the terminals, disconnect the wires from the capacitor terminals (see the photo at the top of the right column).



- b) Discharge the capacitor by short-circuiting its terminals using two screwdrivers with insulated handles.
- c) Loosen the capacitor clamp screw, and remove the capacitor from the clamp.

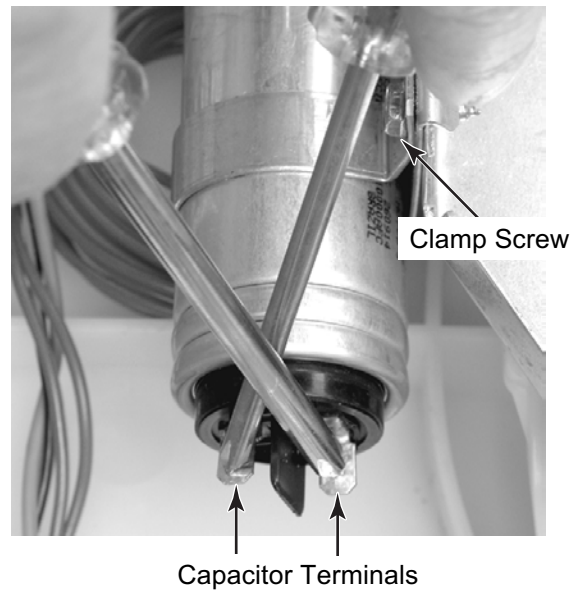

5. To remove the drive motor:

- a) Remove the two 5/16" hex-head screws from the motor cover and remove the cover.

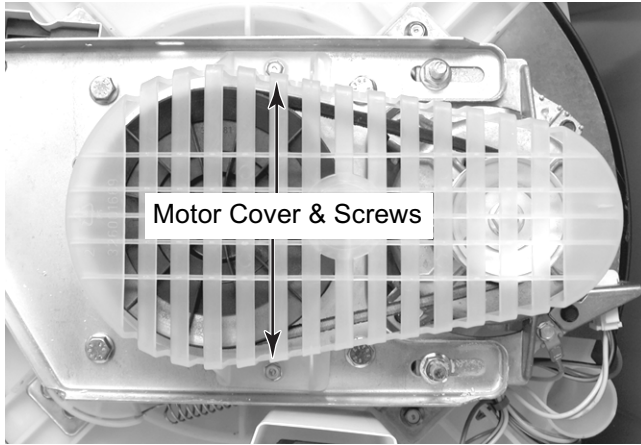

- b) Remove the 1/2" hex-washer nut from the drive motor pulley, and remove the pulley sections, slotted flat washer, and drive belt from the motor.
- c) Press the locking tabs and disconnect the wiring harness connector from the drive motor.
- d) Remove the green ground wire from the motor ground terminal.

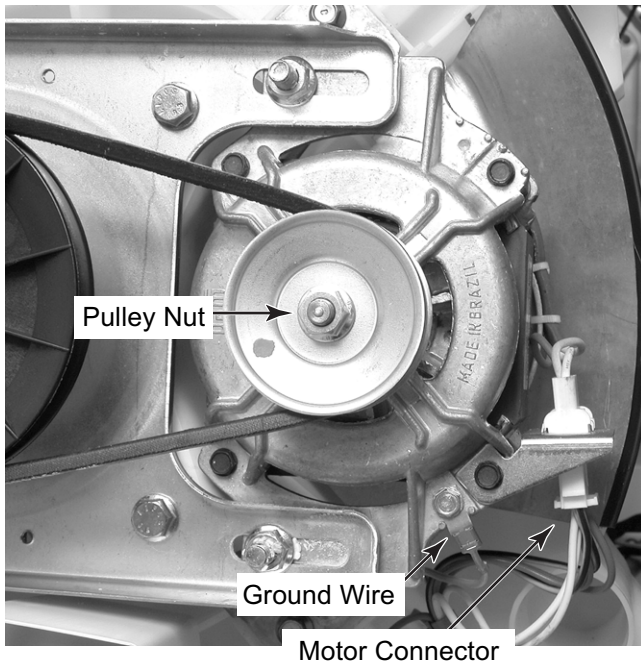

! WARNING



Electrical Shock Hazard
Connect green ground wire to ground terminal.
Failure to do so can result in death or electrical shock.

- e) Remove the two 1/2" carriage bolt nuts from the drive motor and remove the motor and hardware.

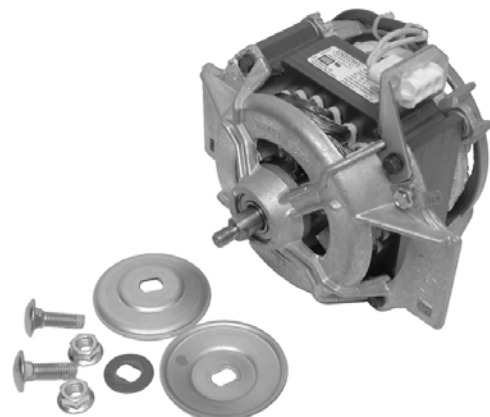
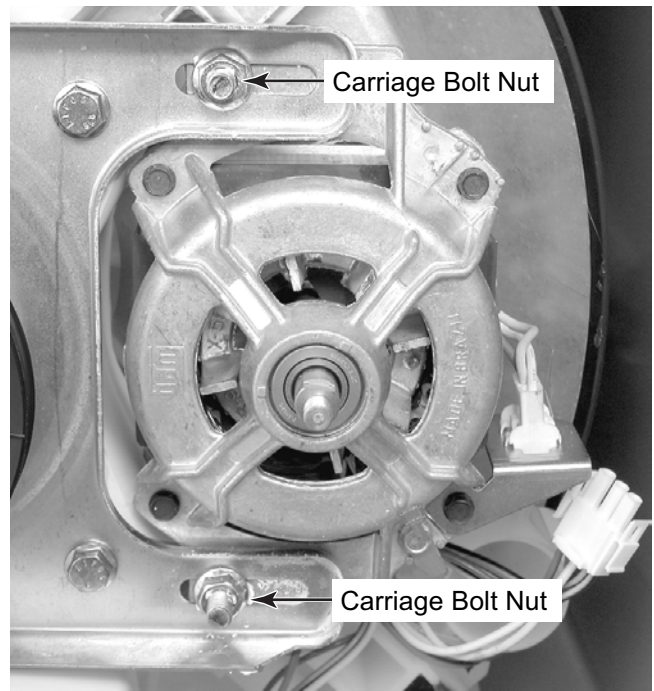

REMOVING THE BRAKE ACTUATOR ASSEMBLY

⚠ WARNING



Electrical Shock Hazard

Disconnect power before servicing.

Replace all parts and panels before operating.

Failure to do so can result in death or electrical shock.

1. Unplug washer or disconnect power.
2. Turn off the water supply to the washer.
3. Tape the lid closed and lay the washer on its rear panel so that you can access the bottom of the unit.

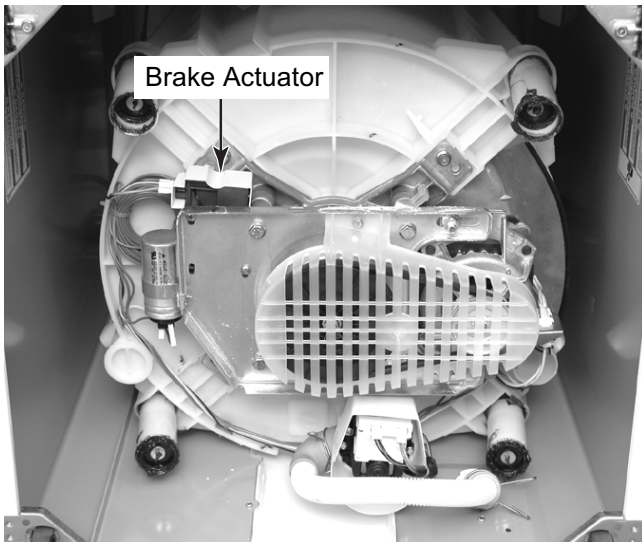

4. Remove the capacitor clamp screw, and remove the capacitor and clamp from the motor support (see the photo at the top of the right column). **NOTE:** Allow the capacitor to hang by its wires out of the way.

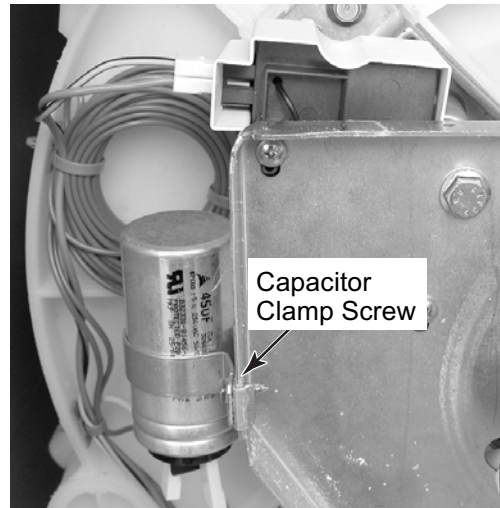

5. Disconnect the two wire connectors from the brake actuator terminals.
6. Remove the two phillips brake actuator screws from the motor support.

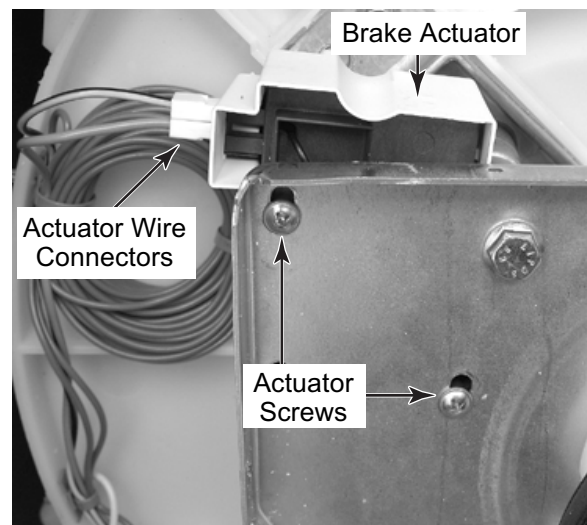

7. Position the brake actuator so you can access the linkage connector. To disconnect the linkage connector:
 - a) Press down on the locking tab of the linkage connector with a small-bladed screwdriver.
 - b) Press in on the tabs of the linkage connector so the pins are out of their holes, and remove the brake actuator.

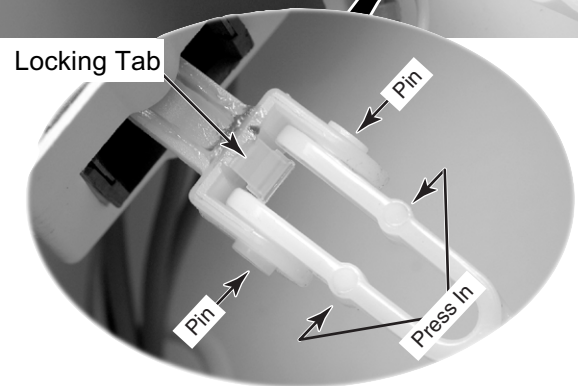
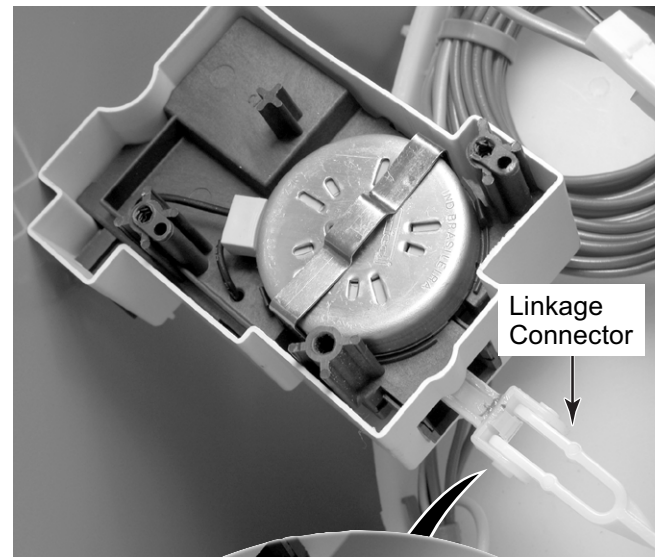

REMOVING THE DRAIN PUMP

⚠️ WARNING



Electrical Shock Hazard

Disconnect power before servicing.

Replace all parts and panels before operating.

Failure to do so can result in death or electrical shock.

1. Unplug washer or disconnect power.
2. Turn off the water supply to the washer.
3. Tape the lid closed and lay the washer on its rear panel so that you can access the bottom of the unit.

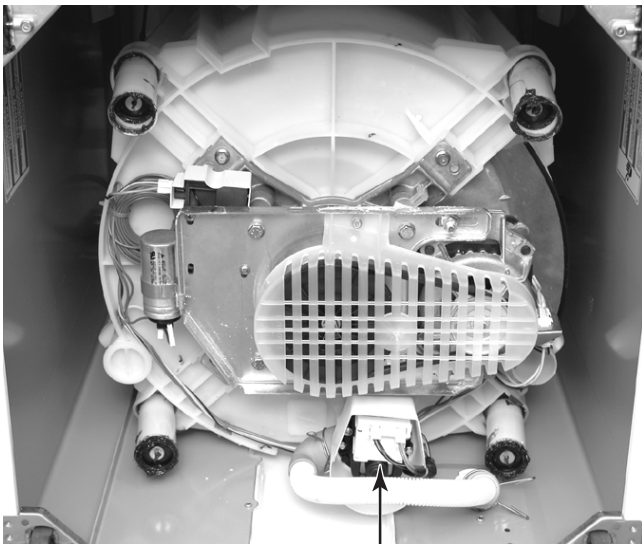

Drain Pump

4. Disconnect the wire connectors from the drain pump terminals.
5. Loosen the clamp, disconnect the hose from the drain pump, and drain the water from the hose and pump into a container.
6. Remove the three hex-head screws from the drain pump housing and remove the housing assembly from the washer.

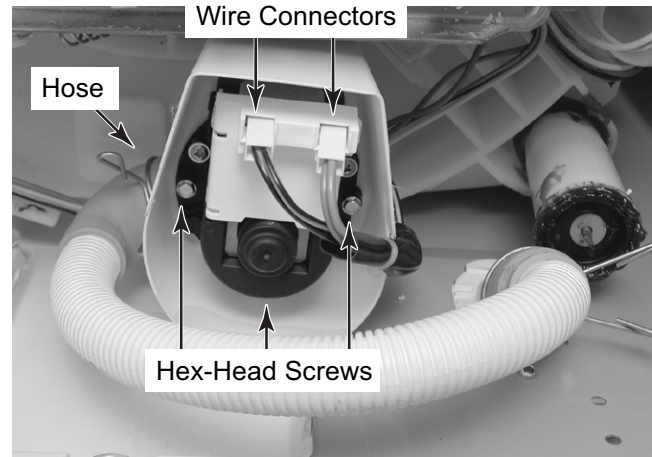

7. Remove the four screws from the drain pump and remove the pump from the housing.

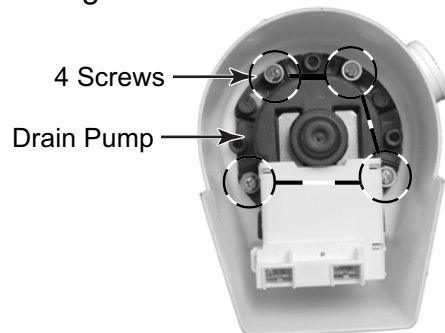

NOTE: Inspect the rubber seals on the drain and pump housing. If they are worn or cracked, replace the seals.

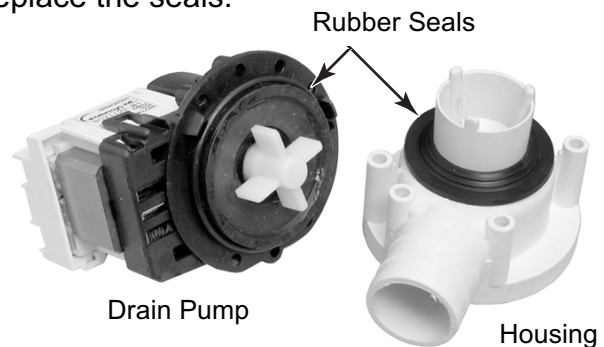

COMPONENT TESTING

Before testing any of the components, perform the following checks:

- Control failure can be the result of corrosion on connectors. Therefore, disconnecting and reconnecting wires will be necessary throughout test procedures.
- All tests/checks should be made with a VOM or DVM having a sensitivity of 20,000 ohms-per-volt DC, or greater.
- Check all connections before replacing components, looking for broken or loose wires, failed terminals, or wires not pressed into connectors far enough.
- Resistance checks must be made with power cord unplugged from outlet, and with wiring harness or connectors disconnected.
- Unless stated otherwise, make all resistance checks by disconnecting the component connector at the electronic control.



⚠ WARNING

Electrical Shock Hazard

Disconnect power before servicing.

Replace all parts and panels before operating.

Failure to do so can result in death or electrical shock.

PRESSURE SWITCH

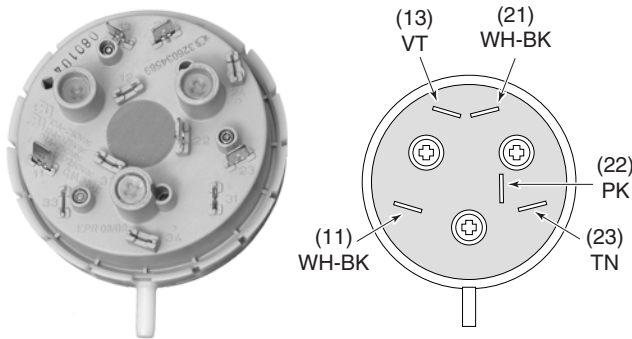

Refer to page 4-2 for the procedure for servicing the pressure switch.

1. Unplug washer or disconnect power.
2. Disconnect the hose and wire connectors from the pressure switch.
3. Set the ohmmeter to the R X 1 scale.
4. Touch the ohmmeter test leads to the pressure switch connector pins shown below. Blow into the pressure switch hose, and the meter should indicate 0 Ω for each measurement.

Water Level Setting Test Points

Empty	Pins 21 and 22
Medium	Pins 13 and 21
High	Pins 22 and 23



⚠️ WARNING

Electrical Shock Hazard

Disconnect power before servicing.

Replace all parts and panels before operating.

Failure to do so can result in death or electrical shock.

WATER INLET VALVE SOLENOIDS

COLD (BLUE)

HOT (RED)

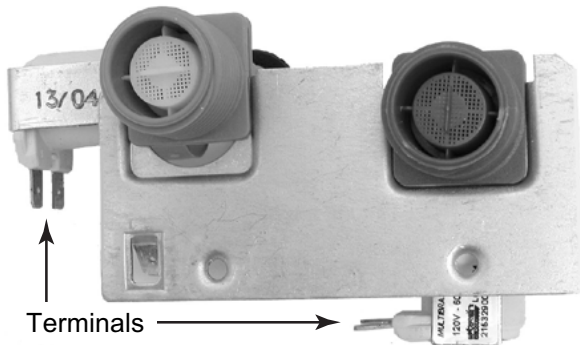

Refer to page 4-2 for the procedure for servicing the water inlet valves.

1. Unplug washer or disconnect power.
2. Disconnect the wires from the water inlet valve solenoid terminals.
3. Set the ohmmeter to the R x 100 scale.
4. Touch the ohmmeter test leads to the hot and cold water inlet valve solenoid terminals. The meter should indicate between 890 and 1090 Ω for both solenoids.

DRIVE MOTOR CAPACITOR

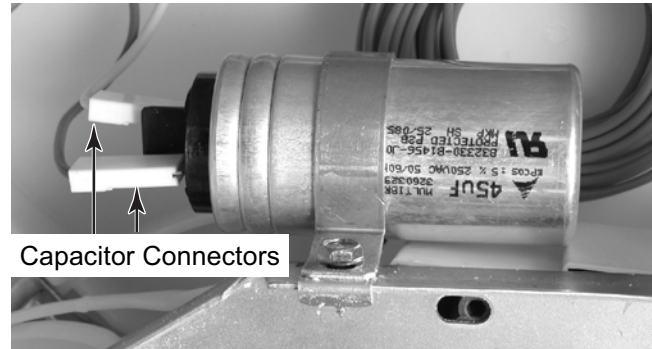

Refer to page 4-14 for the procedure for servicing the drive motor capacitor.

1. Unplug washer or disconnect power.
2. Disconnect the wires from the capacitor terminals.
3. Set the ohmmeter to the R x 1K scale.
4. Touch the ohmmeter test leads to the capacitor terminals. The meter should momentarily deflect toward 0 Ω and then reverse direction toward infinity.



⚠ WARNING

Electrical Shock Hazard

Disconnect power before servicing.

Replace all parts and panels before operating.

Failure to do so can result in death or electrical shock.

BRAKE ACTUATOR

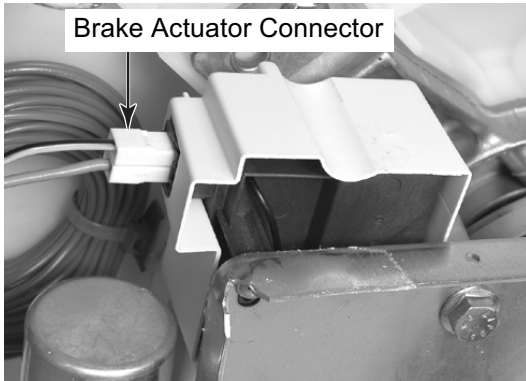

Refer to page 4-16 for the procedure for servicing the brake actuator.

1. Unplug washer or disconnect power.
2. Disconnect the connector from the brake actuator terminals.
3. Set the ohmmeter to the R x 100 scale.

4. Touch the ohmmeter test leads to the two brake actuator terminals. The meter should indicate between 400 and 500 Ω .

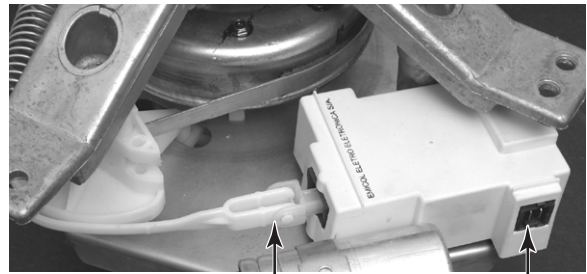

Brake Actuator Linkage Not Activated Connector

5. Rotate the brake arm so that the actuator is in (engaged).
6. Touch the ohmmeter test leads to the two brake actuator terminals. The meter should indicate between 710 and 870 Ω .

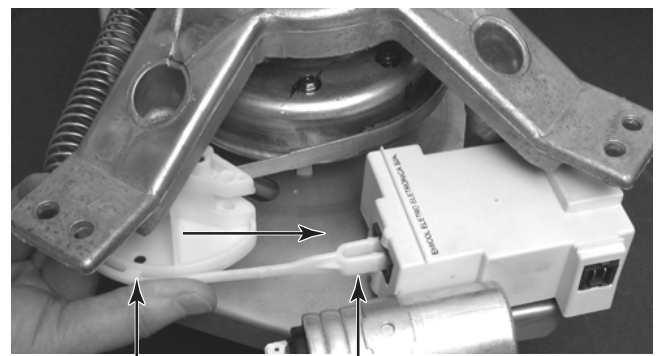

Rotate Brake Arm Brake Actuator Linkage Activated (In)



⚠️ WARNING

Electrical Shock Hazard

Disconnect power before servicing.

Replace all parts and panels before operating.

Failure to do so can result in death or electrical shock.

DRIVE MOTOR

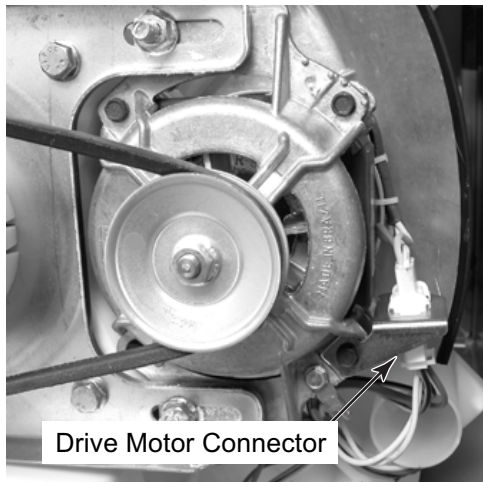

Refer to page 4-14 for the procedure for servicing the drive motor.

1. Unplug washer or disconnect power.
2. Disconnect the connector from the drive motor terminals.
3. Set the ohmmeter to the R x 1 scale.
4. Touch the ohmmeter test leads to the following motor connector pins:
 - a) Red and yellow wires = 12 to 14 Ω .
 - b) Red and white wires = 6 to 7 Ω .
 - c) Yellow and white wires = 6 to 7 Ω .

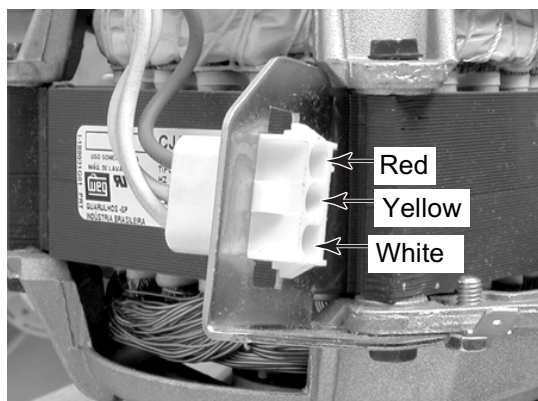

DRAIN PUMP

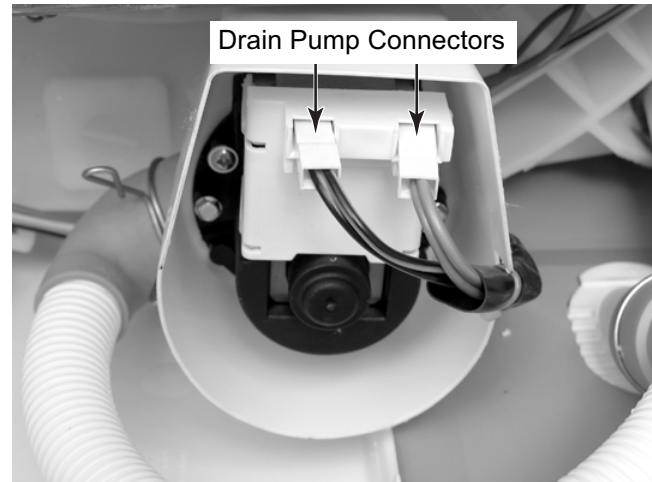

Refer to page 4-18 for the procedure for servicing the drain pump.

1. Unplug washer or disconnect power.
2. Disconnect the connector from the drain pump terminals.
3. Set the ohmmeter to the R x 1 scale.
4. Touch the ohmmeter test leads to the drain pump connector pins. The meter should indicate between 25 and 30 Ω .

DIAGNOSTICS & TROUBLESHOOTING

DIAGNOSTICS

⚠ WARNING	
	<p>Electrical Shock Hazard Disconnect power before servicing. Replace all parts and panels before operating. Failure to do so can result in death or electrical shock.</p>

<p>IMPORTANT</p> <p>Electrostatic Discharge (ESD) Sensitive Electronics</p> <p>ESD problems are present everywhere. ESD may damage or weaken the electronic control board. The new control assembly may appear to work well after repair is finished, but failure may occur at a later date due to ESD stress.</p> <ul style="list-style-type: none">• Use an antistatic wrist strap. Connect wrist strap to green ground connection point or unpainted metal in the appliance. <p>-OR-</p> <p>Touch your finger repeatedly to a green ground connection point or unpainted metal in the appliance.</p> <ul style="list-style-type: none">• Before removing the part from its package, touch the antistatic bag to a green ground connection point or unpainted metal in the appliance.• Avoid touching electronic parts or terminal contacts; handle electronic control board by edges only.• When repackaging failed electronic control board in antistatic bag, observe above instructions.
--

Before servicing, perform the following checks:

- The power cord is firmly plugged into a live circuit with proper voltage. Check the household fuses and circuit breakers.
- The washer is not in a Pause mode?
- Both hot and cold water faucets are open, and the water supply hoses and water inlet screens are unobstructed.
- All tests and checks should be made with a VOM or DVM having a sensitivity of 20,000 ohms-per-volt DC or greater.
- Check all connections before replacing components. Check for broken or loose wires, failed terminals, or wires not completely pressed into the connectors.
- All resistance checks must be made with the power cord unplugged from outlet, and with the wiring harness or connectors disconnected.
- The most common cause for control failure is corrosion on connectors. Therefore, disconnecting and reconnecting wires will be necessary throughout test procedures.

TIME CHARTS

HEAVY DUTY			
CYCLE	TASK	TIME	SPM **
WASH	FILL	VT *	
	AGITATION	16min	62
	DRAIN	VT *	
	SIS ***	1min 12sec	
	SPIN	2min	
	DRAIN	30sec	
RINSE	FILL	VT *	
	AGITATION	4min	62
	DRAIN	VT *	
	SIS ***	1min 12sec	
SPIN	DRAIN	-	
	SPIN	4min	
	DRAIN	30sec	

NORMAL			
CYCLE	TASK	TIME	SPM **
WASH	FILL	VT *	
	AGITATION	12min	66
	DRAIN	VT *	
	SIS ***	1min 12sec	
	SPIN	2min	
	DRAIN	30sec	
RINSE	FILL	VT *	
	AGITATION	4min	66
	DRAIN	VT *	
	SIS ***	1min 12sec	
SPIN	DRAIN	-	
	SPIN	8min	
	DRAIN	30sec	

QUICK WASH			
CYCLE	TASK	TIME	SPM **
WASH	FILL	VT *	
	AGITATION	6min	62
	DRAIN	VT *	
	SIS ***	1min 32sec	
	SPIN	-	
	DRAIN	-	
RINSE	FILL	VT *	
	AGITATION	4min	62
	DRAIN	VT *	
	SIS ***	1min 12sec	
SPIN	DRAIN	-	
	SPIN	4min	
	DRAIN	30sec	

DELICATE			
CYCLE	TASK	TIME	SPM **
WASH	FILL	VT *	
	AGITATION	8min	33
	DRAIN	VT *	
	SIS ***	1min 32sec	
	SPIN	-	
	DRAIN	-	
RINSE	FILL	VT *	
	AGITATION	4min	33
	DRAIN	-	
	SIS ***	-	
SPIN	DRAIN	VT *	
	SIS ***	2min 4sec	
	DRAIN	30sec	

- (*) VT (Variable Time). Not specified due to variability of Water Level and Water Pressure.
- (**) Strokes per Minute.
- (***) SPIN - Spin Intermittent System. Consists of Mini Spin Cycles to distribute clothes in the basket before Spin Cycle.

SELF DIAGNOSTIC FAILURE— ALARM CODES

The washer automatically detects failures during the wash operation. If any of the following

error codes is indicated in the display, the washer's operation will be interrupted. When an error occurs, the Medium Water Level LED will begin to blink, and the Hot and Cold Water Temperature LEDs will turn off.

FAILURE CODE	CAUSE	EVENT AFTER FAILURE	LEDS ALARM CODE
1 Drain time higher than 6 minutes.	<ol style="list-style-type: none"> 1. Pump failure. 2. Pressure switch contact—Medium level failure. 3. Outlet hose is over 72" (1.83 M) high or is clogged. 	When the user places the washer in operation, the electronic control will start a drain task.	
2 Water level sequence reversed (during filling).	<ol style="list-style-type: none"> 1. Wiring pressure switch connection incorrect. 2. Pressure switch contact failure. 3. Pressure switch wires broken or open. 4. Air dome clogged. 5. Pressure hose damaged or improperly connected. 6. Pressure switch damaged. 	To drain the water the technician needs to execute Service routine.	
3 Lower pressure switch opened during agitation.	<ol style="list-style-type: none"> 1. User removed water or clothes from basket after water filling. 2. Water leakage from washer tub. 3. Pressure switch cracked. 4. Pressure hose damaged or improperly connected (loose). 5. Outlet hose improperly connected. 	The electronic control stops the current function and executes a Drain function.	
4 Fill is longer than 20 minutes.	<ol style="list-style-type: none"> 1. Water inlet valve clogged. 2. Water inlet valve damaged. 3. Lower water pressure. 4. No water supply. 	When the user places the washer in operation, it will execute a Fill function with water valve (water temperature) selected before error.	

SERVICE ROUTINE

To initiate the Service Routine, perform the following steps.

Setup

1. Make sure the washer is turned off while it is plugged into a power outlet.
2. Disconnect the power supply cord plug from the outlet and plug it back in.
3. Within 10-seconds of connecting the washer to the electrical supply, simultaneously press the WATER TEMPERATURE and WATER LEVEL keypads. The MEDIUM WATER LEVEL LED will remain on. **NOTE:** If the LED is not on, repeat steps 1 through 3.

Last Error Display

- Simultaneously press the WATER LEVEL and PROGRAM SELECTION keypads. The display will show the last error that occurred.

LED Test

- Press the WATER TEMPERATURE keypad and all of the LEDs should turn on.

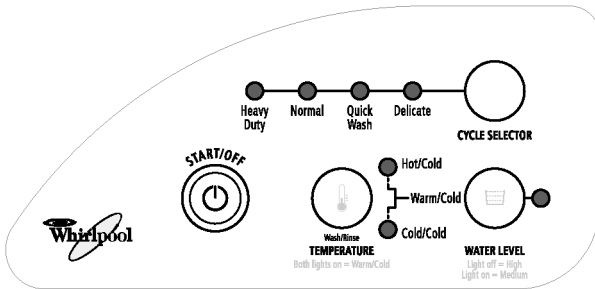

Component Tests

NOTE: The “Component Tests” have four parts. Press the PROGRAM SELECTION keypad to advance the tests.

1. Press the PROGRAM SELECTION keypad. The “Heavy Duty” LED will light, and the cold water inlet valve will be activated. When the cold water reaches the Medium level, the pressure switch will cause the “Heavy Duty” LED to begin blinking.

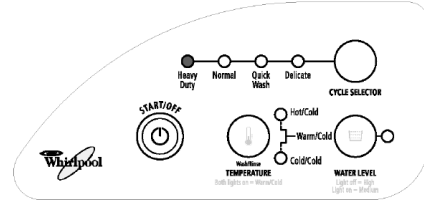

TESTED COMPONENTS	
Cold Inlet Water Valve	X
Hot Inlet Water Valve	
Pressure Switch - Medium Level	X
Pressure Switch - High Level	
Motor	
Brake Actuator (at rest)	
Brake Actuator (on traction)	
Water Pump	

2. Press the PROGRAM SELECTION keypad. The “Normal” LED will light, and the hot water inlet valve will be activated. When the hot water reaches the High level, the pressure switch will cause the “Normal” LED to begin blinking.

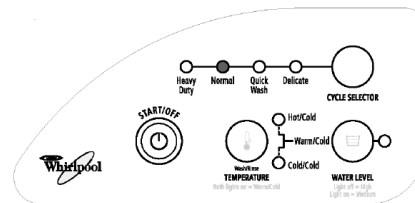

TESTED COMPONENTS	
Cold Inlet Water Valve	
Hot Inlet Water Valve	X
Pressure Switch - Medium Level	
Pressure Switch - High Level	X
Motor	
Brake Actuator (at rest)	
Brake Actuator (on traction)	
Water Pump	

- Press the PROGRAM SELECTION keypad. The “Quick Wash” LED will light, and the motor will start the agitation.

After 15 minutes, the electronic control will turn the motor off, and the “Quick Wash” LED will begin blinking.

NOTE: To end agitation time before the 15 minutes is completed, proceed to the next step.

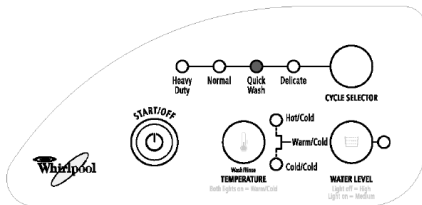

TESTED COMPONENTS	
Cold Inlet Water Valve	
Hot Inlet Water Valve	
Pressure Switch - Medium Level	
Pressure Switch - High Level	
Motor	X
Brake Actuator (at rest)	X
Brake Actuator (on traction)	
Water Pump	

- Press the PROGRAM SELECTION keypad. The “Delicate” LED will light, and the brake actuator and the water pump will activate.

After 20 seconds, the pressure switch will open (Medium Level), and the motor will start the Spin Cycle.

After 10 minutes has elapsed, the “Delicate” LED will begin blinking, and the motor will turn off to complete the Service Routine.

NOTE: If you wish to complete the Service Routine before the 10 minutes has elapsed, press the START/OFF keypad.

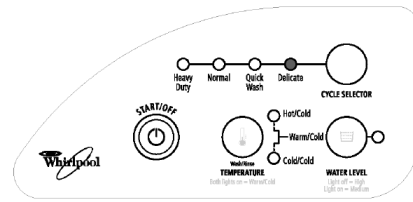

TESTED COMPONENTS	
Cold Inlet Water Valve	
Hot Inlet Water Valve	
Pressure Switch - Medium Level	
Pressure Switch - High Level	
Motor	
Brake Actuator (at rest)	
Brake Actuator (on traction)	X
Water Pump	X

TROUBLESHOOTING GUIDE

PROBLEM	POSSIBLE CAUSE	SOLUTION
LEDs On Panel Do Not Light.	No power supply.	Turn on house breaker or fuse or wait for power to be restored.
	Power cord broken and/or plug terminal loose.	Measure continuity between cable ends.
	Wiring harness open or shorted wiring. Interface board damaged.	Connect or replace the wiring harness. Replace the interface board.
	Electronic control board damaged.	Replace the electronic board.
	Lid switch contact open or shorted.	Check for continuity when closed and no continuity when open.
Selected Program Does Not Run.	Water pump clogged.	Remove the object that is clogging the water pump.
	Water pump damaged.	Replace the water pump.
	Brake lining dirty, misadjusted, or worn.	Clean, adjust, or replace.
	Inlet valve damaged.	Replace the inlet valve (also see "No Water Inlet").
	Motor or capacitor damaged.	See "Motor Does Not Run."
	Wiring harness wiring open or shorted.	Connect or replace the wiring harness.
	Brake actuator burned.	Replace the actuator.
	Electronic control board damaged.	Replace the electronic board.
Washer Will Not Turn On.	START/OFF keypad not activated.	Press the START/OFF keypad.
	Lid open.	Close the lid (washer does not operate with lid open).
	No water.	Check for closed tap or house water supply.
	No power supply.	Turn on house breaker or fuse or wait for power to be restored.
	Low voltage at main house supply.	Check the installation.
	Lid switch open.	Check for continuity when closed and no continuity when open.
	Lid microswitch wiring harness open or shorted.	Measure continuity between wiring.
	Wiring harness wiring open or shorted.	Connect or replace wiring harness.
	Electronic control damaged.	Replace the electronic control.

PROBLEM	POSSIBLE CAUSE	SOLUTION
No Water Inlet. (Hot Or Cold)	Tap closed.	Open the water tap.
	Inlet hose clogged.	Remove the object that is clogging the inlet hose or replace the hose.
	Water inlet clogged or low water pressure.	Unscrew tap hose and proceed with cleaning procedures recommended in the Installation Guide.
	Lid switch open.	Check for continuity when closed and no continuity when open.
	Lid microswitch wiring harness open or shorted.	Measure continuity between wires.
	Hot or cold water inlet valve damaged.	Replace the water inlet valve.
	Electronic control damaged.	Replace the electronic control.
Motor Does Not Run.	Inappropriate electrical installation.	Call an electrician.
	Lid microswitch open or shorted.	Check for continuity when closed and no continuity when open.
	Capacitor opened or shorted.	Discharge capacitor and check with ohmmeter in Rx100 scale. Meter should move towards 0 and then towards infinity.
	Open coil.	Check for continuity.
	Motor windings open or shorted.	Check for continuity.
	Wiring harness wiring open or shorted.	Connect or replace the wiring harness.
	Electronic control damaged.	Replace the electronic control.
Washer Does Not Agitate.	Lid switch open.	Check for continuity when closed and no continuity when open.
	Lid microswitch wiring harness open or shorted.	Check continuity between wires.
	Pressure switch damaged.	Replace pressure switch.
	Pressure switch wires open or shorted.	Check continuity between wires.
	Hose, pressure switch damaged.	Replace hose or pressure switch.
	Motor capacitor damaged.	See "Motor Does Not Run."
	Brake actuator burned.	Replace the actuator.
	Wiring harness wiring open or shorted.	Connect or replace the wiring harness.
	Gearcase assembly locked.	Replace gearcase assembly.
Electronic control damaged.	Replace the electronic control.	

PROBLEM	POSSIBLE CAUSE	SOLUTION
Washer Does Not Drain.	Outlet hose over 72" (1.83 m) in height.	Install hose correctly.
	Lid switch open.	Check for continuity when closed and no continuity when open.
	Lid microswitch wiring harness broken.	Check continuity between wires.
	Pressure switch damaged.	Replace pressure switch.
	Pressure switch or wires broken.	Check continuity between wires.
	Hose, pressure switch damaged.	Replace hose or pressure switch.
	Water pump clogged or damaged.	Remove the object that is clogging the pump or replace the pump.
	Electronic control damaged.	Replace the electronic control.
Water Drained Before End Of Cycle.	Outlet hose installed below minimum height specified 34" (85 cm) from washer base.	Refer to Installation Guide and keep hose length over 34" (85 cm) and below 48" (1.20m)
	Electronic control damaged.	Replace the electronic control.
Water Leakage / Water Level Overflow.	Clothes added after water filling.	Put in clothes before water filling.
	Inlet hose improperly connected.	Install hose correctly.
	Outlet hose improperly connected.	Install hose correctly.
	Pressure switch contacts damaged or pressure switch hose loose/damaged.	Check continuity. Also visually check hose.
	Pressure switch or wires broken.	Check continuity between wires.
	Seal damaged.	Replace seal.
	Rubber seal damaged.	Replace rubber seal.
	Air dome clogged.	Remove the object that is clogging the air dome.
	Inlet water valve opened.	Replace water inlet valve.
	Electronic control damaged.	Replace the electronic control.
Washer Does Not Spin.	Too much detergent.	Wait approximately 30 minutes and repeat the "Normal Wash" cycle. Make sure that the correct amount of detergent is used.
	Lid switch open.	Check for continuity when closed and no continuity when open.
	Lid microswitch wiring harness broken.	Check continuity between wires.
	Wedge not tightened.	Tighten the wedge.
	Brake actuator burned.	Replace the actuator.
	Wiring harness open or shorted.	Connect or replace the wiring harness.
	Pressure switch damaged.	Replace the pressure switch.
	Pressure switch wires open or shorted.	Check continuity between wires.
	Hose, pressure switch damaged.	Replace the hose or pressure switch.
	Water pump clogged or damaged.	Remove the object that is clogging the water Pump or replace the pump.
	Motor or capacitor damaged.	See "Motor Does Not Run."
	Mechanism assembly locked.	Replace the mechanism assembly.
Electronic control damaged.	Replace the electronic control.	

PROBLEM	POSSIBLE CAUSE	SOLUTION
Noise, Vibration, Displacement.	Unleveled washer.	Verify that floor is level under washer.
	Improper clothes distribution in basket.	Inform consumer how to distribute clothes correctly.
	Too many clothes.	Use only recommended weight of clothes.
	Wiring harness hitting the cabinet.	Fix wiring harness.
	Hose, outlet hitting the cabinet.	Fix hose.
	Cam assembly scratching.	Check spring and cam/traction arm assembly.
	Oil leakage through inlet axle.	Check mechanism assembly.
	Mechanism assembly inlet axle worn.	Check mechanism assembly.
	Seal damaged.	Replace seal.
	Bearing damaged.	Replace bearing.
	Brake lining worn.	Replace brake lining.
	Suspension bar connecting rod broken.	Replace connecting rod.
	Strap snubber broken.	Replace strap snubber.
	Suspension bar broken or warped.	Replace suspension bar.
Balance ring not in position or is leaking.	Place in correct position, replace if necessary.	
Low Water Level Operation Sound.	Water used in balance ring system.	Normal sound.
Noise & Crackling Sound.	Water draining.	Normal noise of Washer.
	Hose striking on washer housing.	Normal sound or place hose away from washer housing.
	Noise during water filling.	Normal sound in washer tub suspension.
Stops During Cycle.	Low water pressure.	Call a plumber.
	Water inlet hose bent.	Install properly.
	Unlevelled washer.	Verify that the floor below the washer is level.
	Detergent hardened.	Use good quality detergent.
	Filtering screen clogged.	Unscrew tap hose and proceed with cleaning procedures recommended in Installation Guide.
Clothes Damaged.	Inappropriate program used.	Use a wash program that is according to the type of clothes.
	Pins, belts, zippers opened.	Remove metallic accessories and close the zippers.
	Inappropriate water level used.	Use a wash program that is according to the quantity of clothes.
	Inappropriate bleach used on colored clothes.	Do not use bleach for white clothes on colored clothes.

PROBLEM	POSSIBLE CAUSE	SOLUTION
Poor Washing.	Cloth weight incorrect for water volume selected.	Use a wash cycle that is according to the clothes quantity.
	Program incorrect for type of clothes.	Use a wash cycle that is according to the clothes type.
	Quick Wash cycle selected for very dirty clothes.	This cycle is only appropriate for lightly soiled clothes.
	Lint filter.	Clean the filter after each washing cycle.
	Detergent hardened or too little detergent used.	Use a good quality detergent and the correct quantity.
Plastic Parts Are Cracked.	Chemical cleaning products.	Recommend cleaning with a damp cloth and mild soap.

WIRING DIAGRAM & STRIP CIRCUITS

WIRING DIAGRAM

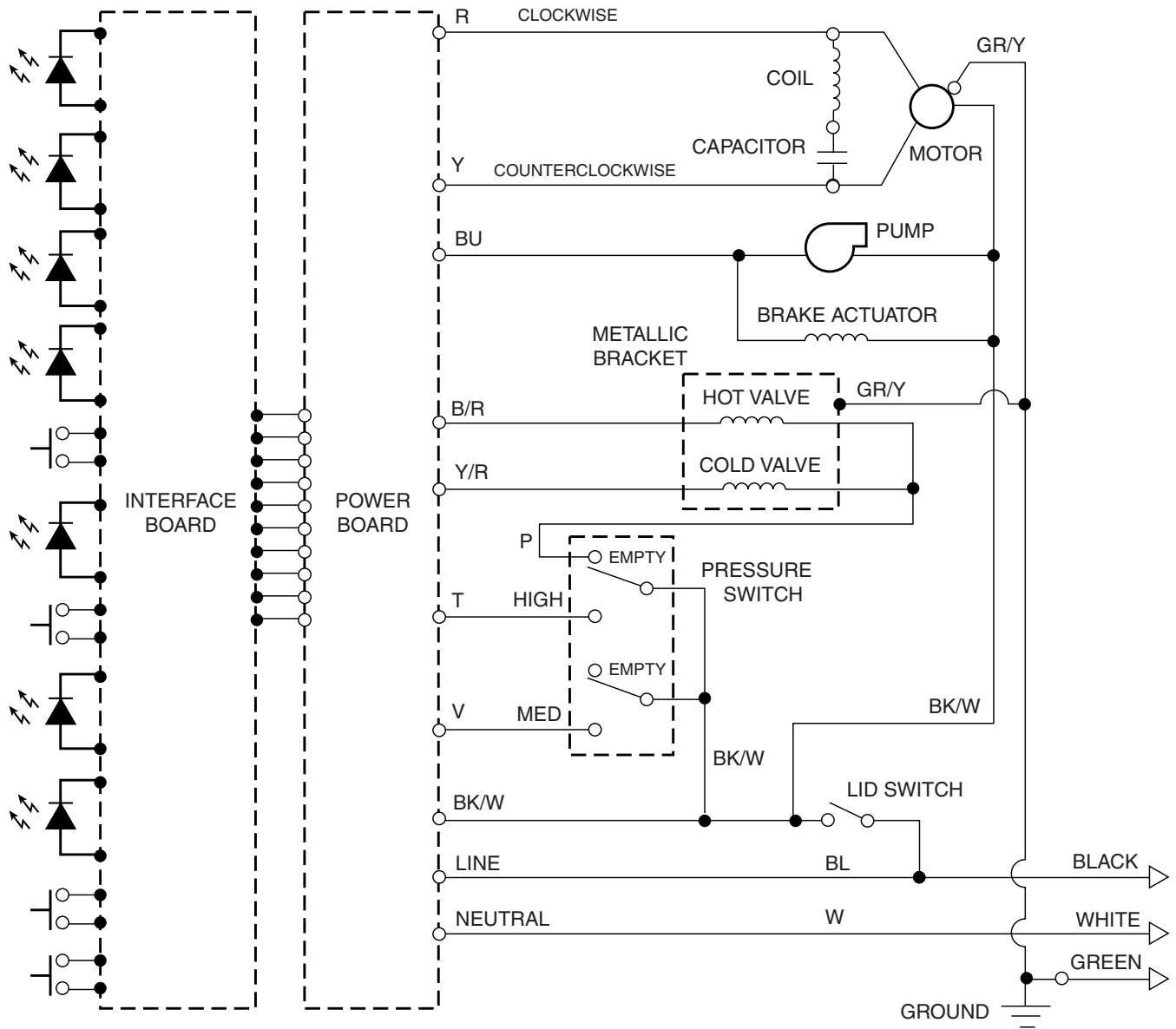

STRIP CIRCUITS

FILL

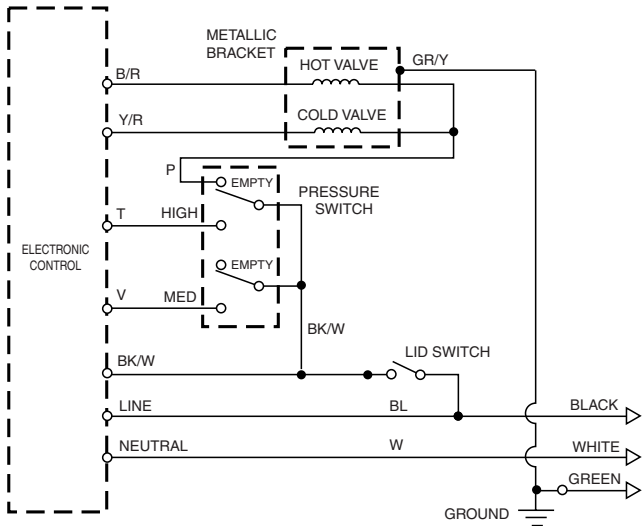

SPIN

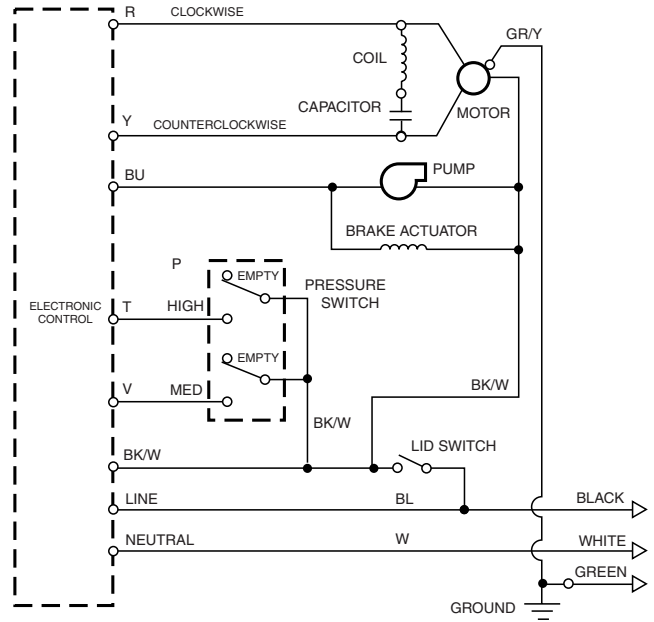

AGITATE

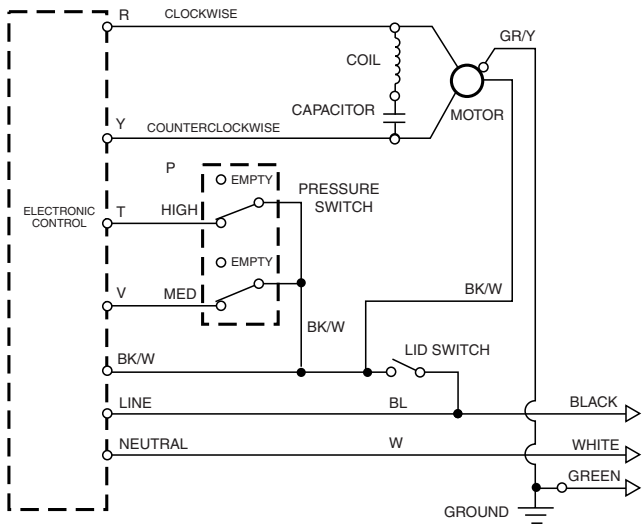

DRAIN

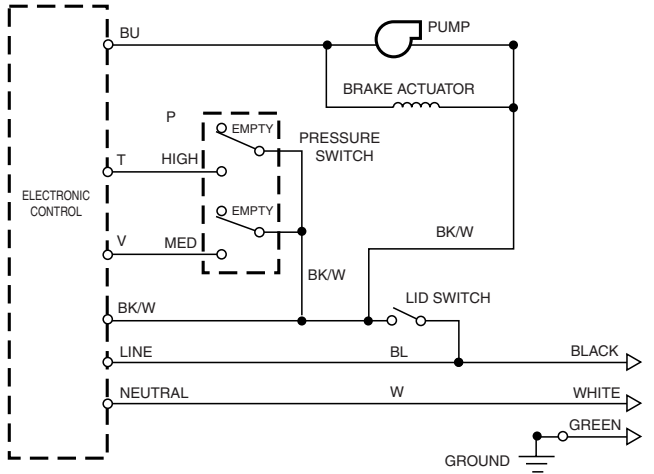

PRODUCT SPECIFICATIONS AND WARRANTY INFORMATION SOURCES

IN THE UNITED STATES:

FOR PRODUCT SPECIFICATIONS AND WARRANTY INFORMATION CALL:

FOR WHIRLPOOL PRODUCTS: 1-800-253-1301
FOR KITCHENAID PRODUCTS: 1-800-422-1230
FOR ROPER PRODUCTS: 1-800-447-6737

FOR TECHNICAL ASSISTANCE WHILE AT THE CUSTOMER'S HOME CALL:

THE TECHNICAL ASSISTANCE LINE: 1-800-253-2870

**HAVE YOUR STORE NUMBER READY TO IDENTIFY YOU AS AN
AUTHORIZED SERVICER**

FOR LITERATURE ORDERS:

PHONE: 1-800-851-4605

FOR TECHNICAL INFORMATION AND SERVICE POINTERS:

www.servicematters.com

IN CANADA:

FOR PRODUCT SPECIFICATIONS AND WARRANTY INFORMATION CALL:

1-800-461-5681

FOR TECHNICAL ASSISTANCE WHILE AT THE CUSTOMER'S HOME CALL:

THE TECHNICAL ASSISTANCE LINE: 1-800-488-4791

**HAVE YOUR STORE NUMBER READY TO IDENTIFY YOU AS AN
AUTHORIZED SERVICER**

