



CONSUMER SERVICES TECHNICAL  
EDUCATION GROUP PRESENTS

R-98

# GLADIATOR GARAGE WORKS™ FREEZERATOR™



Model GAFZ21XXMK00

JOB AID  
Part No. 8178384

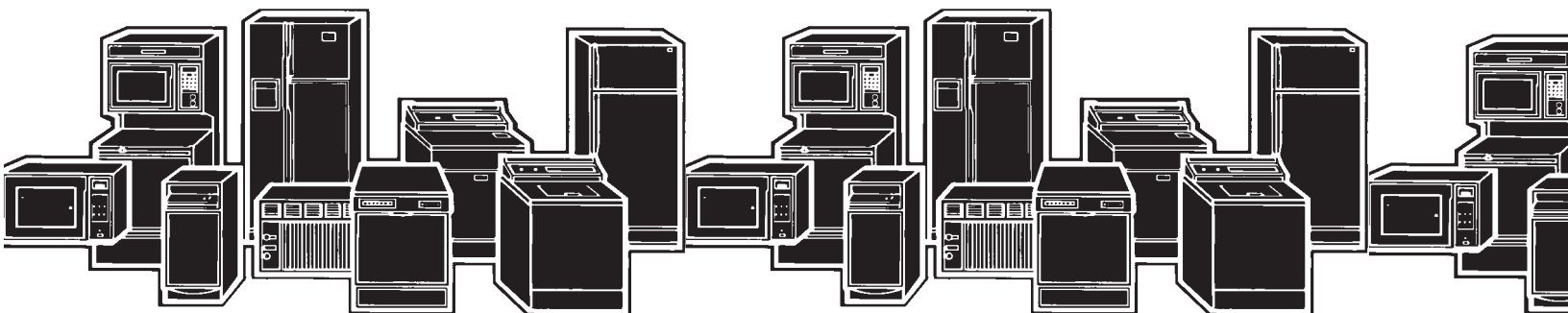

# FORWARD

This Whirlpool Job Aid, “Gladiator Garage Works™ Freezerator™” (Part No. 8178384), provides the technician with information on the operation and service of the Gladiator Garage Works™ Freezerator™. It is to be used as a training Job Aid and Service Manual. For specific information on the model being serviced, refer to the “Use and Care Guide,” or “Tech Sheet” provided with the refrigerator.

The Wiring Diagrams and Strip Circuits used in this Job Aid are typical and should be used for training purposes only. Always use the Wiring Diagram supplied with the product when servicing the unit.

## GOALS AND OBJECTIVES

The goal of this Job Aid is to provide detailed information that will enable the service technician to properly diagnose malfunctions and repair the Gladiator Garage Works™ Freezerator™.

The objectives of this Job Aid are to:

- Understand and follow proper safety precautions.
- Successfully troubleshoot and diagnose malfunctions.
- Successfully perform necessary repairs.
- Successfully return the refrigerator to its proper operational status.

WHIRLPOOL CORPORATION assumes no responsibility for any repairs made on our products by anyone other than Authorized Service Technicians.

# TABLE OF CONTENTS

	Page
<b>GENERAL</b> .....	1-1
Safety First .....	1-1
Model & Serial Number Designations .....	1-3
Model & Serial Number Label Location .....	1-4
Specifications .....	1-5
<b>THEORY OF OPERATION</b> .....	2-1
Overview .....	2-1
<b>COMPONENT ACCESS</b> .....	3-1
Component Locations .....	3-1
Removing The Top Compartment Thermostat And The Freezer/Refrigerator Selector Switch .....	3-2
Removing The Auxiliary Heater .....	3-5
Removing The Top Compartment Light Socket And Door Switch .....	3-6
Removing The Evaporator Fan Motor, Liner Heater Bimetal & Defrost Bimetal, Defrost Heater, And Evaporator .....	3-8
Removing The Bottom Compartment Thermostat, Defrost Control, Light Socket, And Door Switch .....	3-11
Removing The Condenser Fan Motor And Ambient Bimetal .....	3-13
Removing The Relay/Overload And Run Capacitor Assembly And The Compressor .....	3-15
Removing A Caster .....	3-17
Removing A Roller And Condenser Fan Motor Housing .....	3-18
<b>COMPONENT TESTING</b> .....	4-1
Top Compartment Thermostat & Freezer/Refrigerator Selector Switch .....	4-1
Defrost Bimetal & Defrost Heater .....	4-2
Auxiliary Heater .....	4-3
Liner Heater .....	4-3
Liner Heater Bimetal .....	4-4
Ambient Bimetal .....	4-4
Bottom Compartment Thermostat .....	4-5
Door Switch .....	4-5
Relay/Overload & Run Capacitor .....	4-6
Compressor .....	4-6

	<b>Page</b>
<b>DIAGNOSTICS &amp; TROUBLESHOOTING</b> .....	5-1
Diagnostics .....	5-1
Adaptive Defrost Control (ADC) Test Mode .....	5-1
Troubleshooting Chart .....	5-2
<b>WIRING DIAGRAMS &amp; STRIP CIRCUITS</b> .....	6-1
Wiring Diagram 1 .....	6-1
Wiring Diagram 2 .....	6-2
Strip Circuits .....	6-3

# GENERAL SAFETY FIRST

## Your safety and the safety of others is very important.

We have provided many important safety messages in this Job Aid and on the appliance. Always read and obey all safety messages.



This is the safety alert symbol.

This symbol alerts you to hazards that can kill or hurt you and others.

All safety messages will follow the safety alert symbol and either the word “DANGER” or “WARNING.” These words mean:

**! DANGER**

You can be killed or seriously injured if you don't immediately follow instructions.

**! WARNING**

You can be killed or seriously injured if you don't follow instructions.

All safety messages will tell you what the potential hazard is, tell you how to reduce the chance of injury, and tell you what can happen if the instructions are not followed.

**! WARNING**



### Electrical Shock Hazard

**Disconnect power before servicing.**

**Replace all parts and panels before operating.**

**Failure to do so can result in death or electrical shock.**

**! WARNING**



### Electrical Shock Hazard

**Plug into a grounded 3-prong outlet.**

**Do not remove ground prong.**

**Do not use an adapter.**

**Do not use an extension cord.**

**Failure to follow these instructions can result in death, fire, or electrical shock.**

## **! WARNING**



### **Electrical Shock Hazard**

**Connect green ground wire to ground screw.**

**Failure to do so can result in death or electrical shock.**

## **ELECTROSTATIC DISCHARGE (ESD) SENSITIVE ELECTRONICS**

ESD problems are present everywhere. ESD may damage or weaken the electronic control assembly. The new control assembly may appear to work well after repair is finished, but failure may occur at a later date due to ESD stress.

- Use an antistatic wrist strap. Connect the wrist strap to a green ground connection point or unpainted metal in the appliance; or touch your finger repeatedly to a green ground connection point or unpainted metal in the appliance.
- Before removing the part from its package, touch the antistatic bag to a green ground connection point or unpainted metal in the appliance.
- Avoid touching electronic parts or terminal contacts. Handle the electronic control assembly by the edges only.
- When repackaging the failed electronic control assembly in an antistatic bag, observe the above instructions.

# MODEL & SERIAL NUMBER DESIGNATIONS

## MODEL NUMBER

<b>MODEL NUMBER</b>	<b>GA</b>	<b>FZ</b>	<b>21</b>	<b>XX</b>	<b>M</b>	<b>K</b>	<b>00</b>
<b>BRAND</b>							
<b>PRODUCT GROUP</b>							
AC = Accessory							
CP = Compactor							
CS = Cleaning Station							
DP = Display For Trade Partner							
FL = Flooring							
FM = Floor Module							
FZ = Freezerator							
GB = Gear Box							
GD = Gear Drawer							
GP = Gator Pak							
RF = Refrigerator							
RK = Gear Rack							
TB = Tall Gear Box							
TL = Tall Gear Locker							
VA = Vacuum							
WA = Wall Accessory							
WB = Workbench							
WG = Wall Gear Box							
<b>CAPACITY/CUBIC FOOT</b>							
<b>SIZE (IN / FT / OR CU FT)</b>							
05 = 5 cu ft or 5'							30 = 30"
06 = 6'							XX = No Size
08 = 8'							
10 = 10'							
15 = 15"							
18 = 18"							
19 = 19"							
21 = 21 cu ft							
24 = 24"							
27 = 27"							
28 = 28"							
<b>MODEL TYPE</b>							
1D = One Door							PD = Pump Drain
2D = Two Doors							PS = Power Strip
1P = One Piece							SF = Shelf
2P = Two Pieces							SH = S Hook
6P = Six Pieces							SK = Starter Kit
BD = Builder Display							SR = Shoe Rack
BH = Big Hook							TH = Tool Hook
BK = Basket							TR = Tool Rack
DD = Direct Drain							UH = Utility Hook
DH = Deep Hook							VB = Vert. Bike Hook
MT = Maple Top							WH = Wheelbarrow Hook
							XX = No Type
<b>YEAR OF INTRODUCTION</b>							
M = 2003, P = 2004, R = 2005							
<b>COLOR CODE</b>							
G = Hammered Granite							Y = Gray
H = Hammered Graphite							X = No Color
K = Graphite							
<b>ENGINEERING CHANGE (NUMERIC)</b>							
00 = Original, 01 = 1st Change, 02 = 2nd Change, Etc.							

## SERIAL NUMBER

<b>SERIAL NUMBER</b>	<b>E</b>	<b>P</b>	<b>03</b>	<b>10001</b>
<b>MANUFACTURING SITE</b>				
E = Evansville, IN				
<b>YEAR OF PRODUCTION</b>				
P = 2003				
<b>WEEK OF PRODUCTION</b>				
03 = 3rd Week				
<b>PRODUCT SEQUENCE NUMBER</b>				

# MODEL & SERIAL NUMBER LABEL LOCATION

The Model/Serial Number Label location is shown below.

**Model & Serial Number Location  
(Upper Left Refrigerator Liner)**





## SPECIFICATIONS

<b>MODEL NUMBER</b>	<b>GAFZ21XXMK</b>
Total AHAM Volume (Cu Ft)	21.0
Top Compartment Volume (Cu Ft)	5.67
Freezer Volume (Cu Ft)	15.37 Bottom Compartment
Total AHAM Shelf Area (Sq Ft)	29.9
<b>Exterior Dimensions (Nearest 1/8")</b>	
Cabinet Height (Floor To Top Of Cabinet) (in)	72 3/4"
Overall Height (Floor To Top Of Hinge Covers) (in)	73 3/4"
Cabinet Width (in)	33 1/8"
Overall Depth (Including Hardware & Handles) (in)	31 1/2"
Depth - Less Doors/Base Grille (Minimum Opening) (in)	26 7/8"
Weight (Indicate Net/Shipping/Crated)	271 lb/280 lb/280 lb
<b>Exterior</b>	
Factory-Built Door Swing	Right-Hand Reversible
Cabinet Color(s)	Graphite
Exterior Door	Contoured / Tread Plate Silver Tread
Warranty	12 Month Standard 60 Month Full Liner & Sealed System

— NOTES —

# THEORY OF OPERATION

## OVERVIEW

The Gladiator Garage Works™ Freezerator™ is a freezer with a top compartment that is convertible to a refrigerator or freezer. Freezerator is designed to operate properly in the temperatures often found in a typical garage.

Freezerator's sealed system uses a larger capacity compressor, an increased refrigerant charge, more fins on the evaporator, and a faster speed evaporator fan motor. These changes allow Freezerator to operate properly in higher-than-normal ambient temperatures.

Other sealed system changes include a suction line accumulator that allows the unit to operate safely in low ambient temperatures, and a heat loop that surrounds both compartments.

To allow the top compartment to operate as a refrigerator, insulation has been added to the evaporator cover, and two heaters have been added to the top compartment. A unit compartment bimetal, located on the compressor process stub, opens at 88°F (31°C), and closes at 76°F (24°C). These temperatures translate into the following ambient (room) temperatures: opens at 60°F (16°C), and closes at 55°F (13°C).

When this ambient bimetal closes, and the top compartment is set for refrigeration, the 18 watt liner heater is energized. A 60 watt heater that is attached to the back of the evaporator cover is cycled on and off by the convertible compartment thermostat during the refrigeration mode, and maintains the refrigeration temperature in the convertible compartment.

During the defrost cycle, if the top compartment is set to "freezer" mode, the 60 watt evaporator cover heater may be used, in addition to the defrost heater, to aid in frost removal. The 60 watt evaporator cover heater will only operate during defrost if the top compartment thermostat is closed, and is set to the freezer mode. The 18 watt top compartment liner heater will also operate during defrost if the ambient bimetal is closed.

The bottom compartment thermostat maintains the proper freezer temperatures for that section by controlling the compressor run time. The bottom compartment thermostat also controls the top compartment whenever it is used for freezer operation.

The top compartment controls consist of a thermostat and a rocker switch. The switch allows the compartment mode change from freezer to refrigerator, while the thermostat portion allows temperature control during refrigeration operation. The rated ambient operating temperature of Freezerator is from 20 to 110°F (-6.6 to 43°C). Operation as low as 0°F (-17.7°C) is possible if the top compartment is operated either in the freezer mode, or is set to the WARM refrigeration position.

Freezerator uses an electronic Adaptive Defrost Control that incorporates "evaporator fan delay." When the compressor cycles on, the evaporator fan is delayed for 40 seconds. When the compressor cycles off, the fan continues to run for an additional 4 minutes. After a defrost cycle, the compressor is delayed for 3 minutes, and the evaporator fan is delayed for an additional 3 minutes (6 minutes total).

— NOTES —

# COMPONENT ACCESS

This section instructs you on how to service each component inside the Freezerator. The components and their locations are shown below.

## COMPONENT LOCATIONS

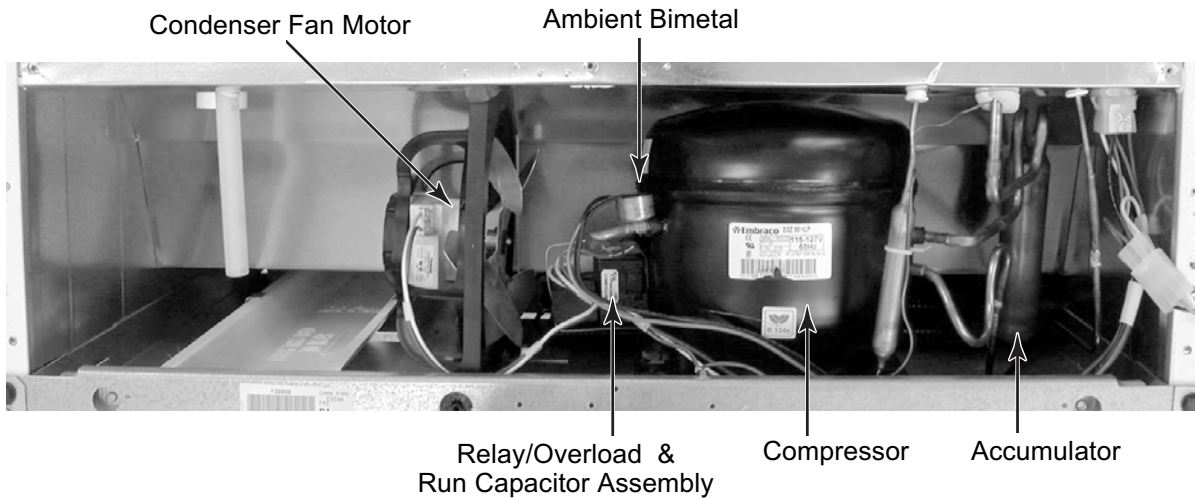

# REMOVING THE TOP COMPARTMENT THERMOSTAT AND THE FREEZER/REFRIGERATOR SELECTOR SWITCH

## ⚠️ WARNING



### Electrical Shock Hazard

**Disconnect power before servicing.  
Replace all parts and panels before operating.  
Failure to do so can result in death or electrical shock.**

1. Unplug refrigerator or disconnect power.
2. Open the top compartment door, remove the items from the shelf, and remove the shelf.
3. Remove the two screws from the wiring cover and remove the cover.

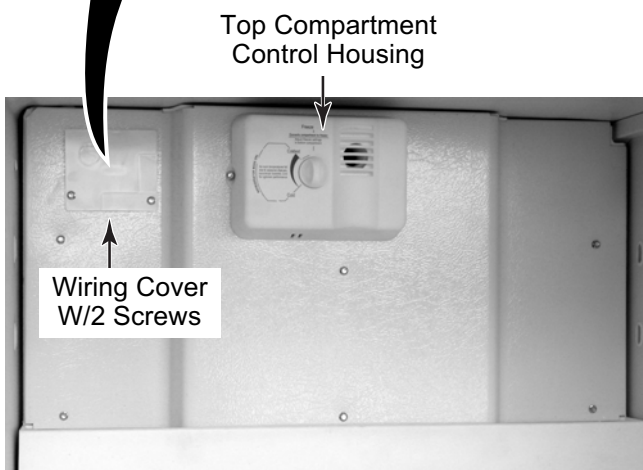
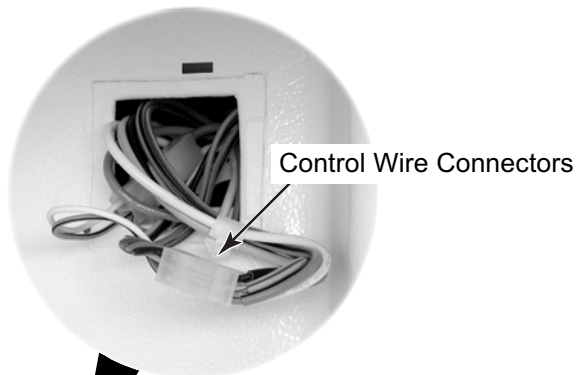

4. Pull the 6-pin wire connectors for the top compartment control components out of the opening and disconnect them (see the round inset in the lower left column).
5. Remove the six hex-head screws from the outer evaporator cover.
6. Pull the top of the outer evaporator cover forward and remove the cover assembly from the top compartment. Place the assembly on a work surface with the control housing facing down.

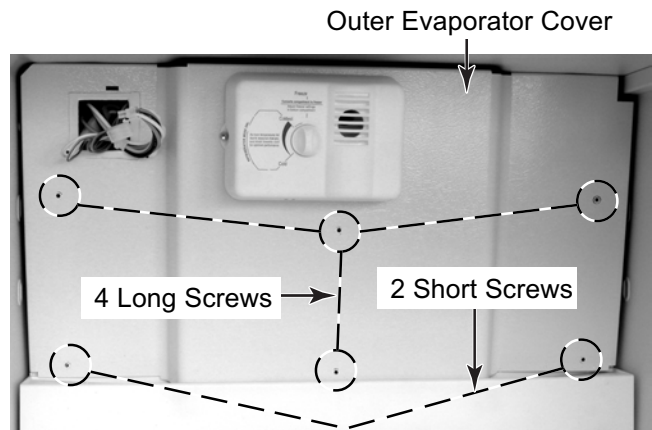

7. Disconnect the 2-wire heater connector.
8. Unhook the wires from the clip and push the rubber grommet out of the cover cut-out.
9. Slide the green ground wire clip off the edge of the cover.

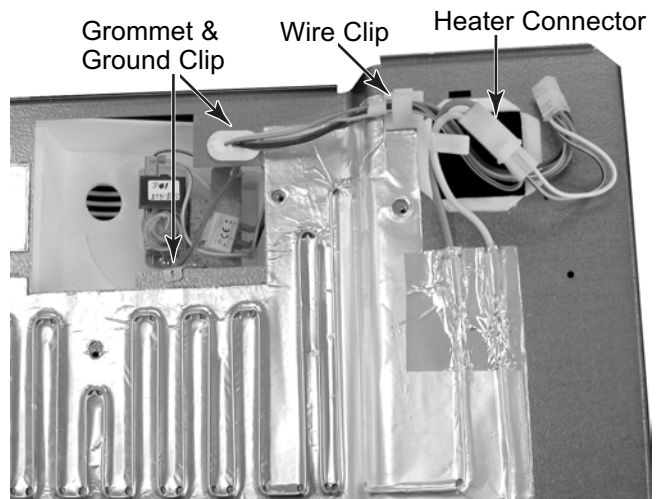

10. Remove the screw from the top compartment control housing.
11. Lift the top compartment control housing from the outer evaporator cover, pull the wires through the cutout, and position the housing with the component side facing up.

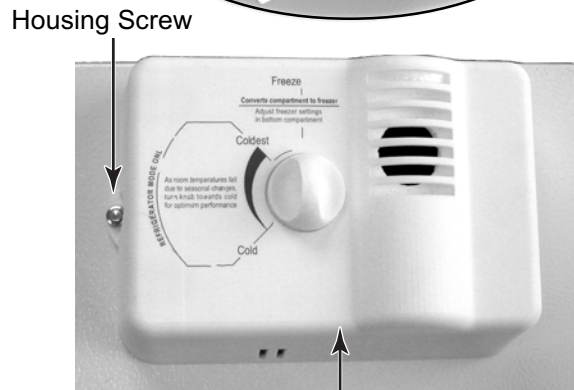
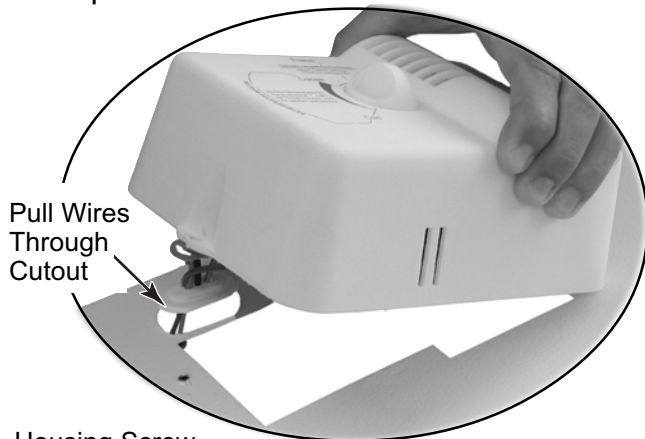

Top Compartment Control Housing

12. Remove the two hex-head screws from the top compartment thermostat bracket and remove the bracket assembly from the control box.

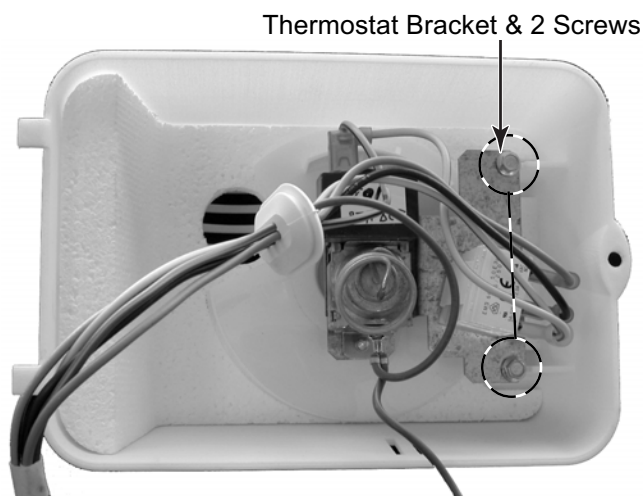

13. **To remove the top compartment thermostat:**

- a) Pull the knob/baffle off the thermostat shaft.
- b) Disconnect the 3 wire connectors from the thermostat terminals.
- c) Remove the two hex-head screws from the thermostat and remove the thermostat from the bracket.

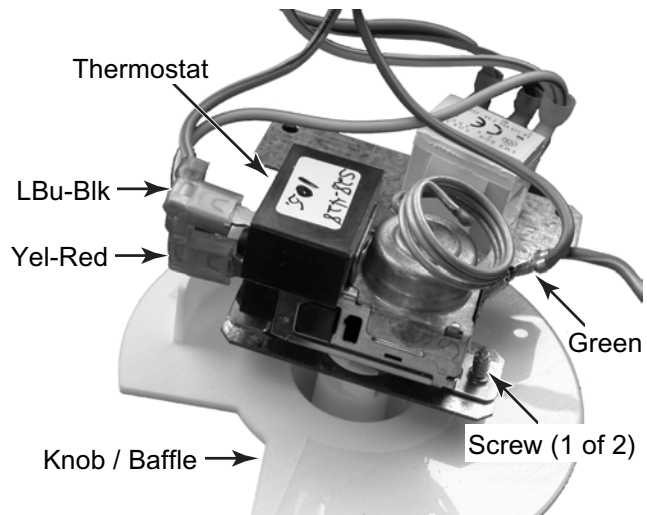

14. **To remove the freezer/refrigerator selector switch:**

- a) Pull the knob/baffle off the thermostat shaft.
- b) Disconnect the 3 wire connectors from the switch terminals.

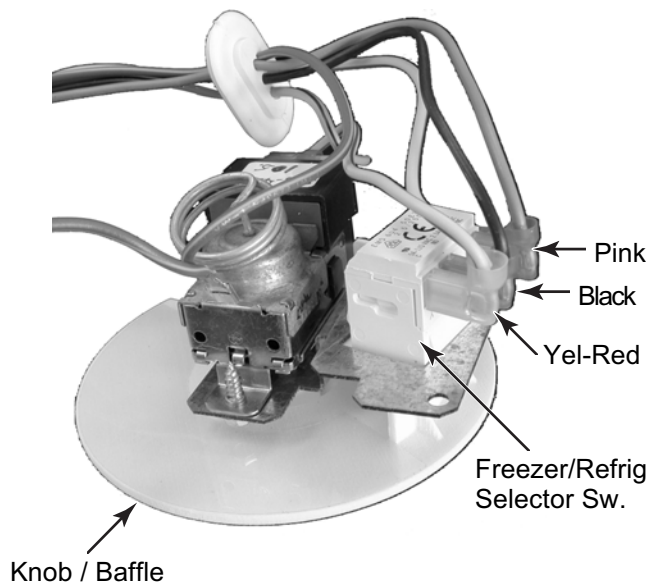

Continued on the next page.

c) Push in on the locking tab of the switch and push it out of the bracket cutout.

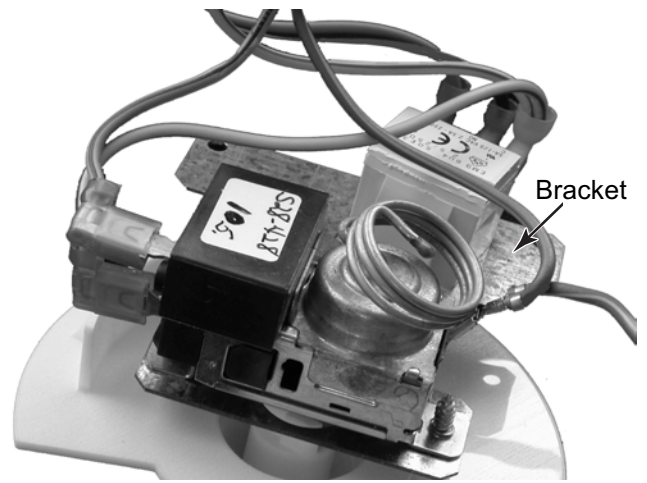



## REMOVING THE AUXILIARY HEATER

### **!WARNING**



**Electrical Shock Hazard**  
**Disconnect power before servicing.**  
**Replace all parts and panels before operating.**  
**Failure to do so can result in death or electrical shock.**

1. Unplug refrigerator or disconnect power.
2. Remove the outer evaporator cover (see steps 2 through 7 on page 3-2 for the procedure).

3. Peel the auxiliary heater off the outer evaporator cover and install the new one in its place.

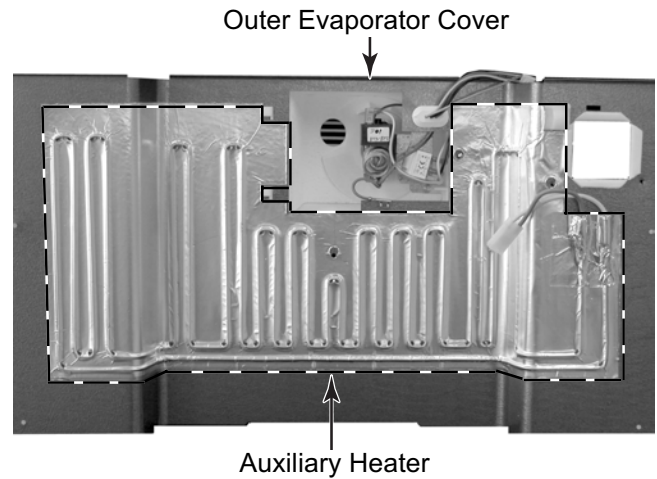

## REMOVING THE TOP COMPARTMENT LIGHT SOCKET AND DOOR SWITCH

### **!WARNING**



**Electrical Shock Hazard**  
Disconnect power before servicing.  
Replace all parts and panels before operating.  
Failure to do so can result in death or electrical shock.

1. Unplug refrigerator or disconnect power.
2. Open the top compartment door and remove any items from around the light and door switch housing.

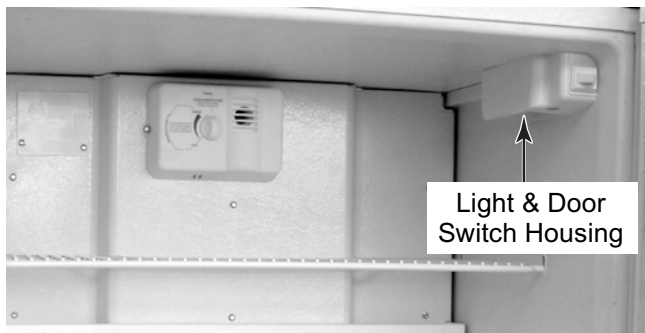

3. Remove the screw from the light and door switch housing and lower the housing.

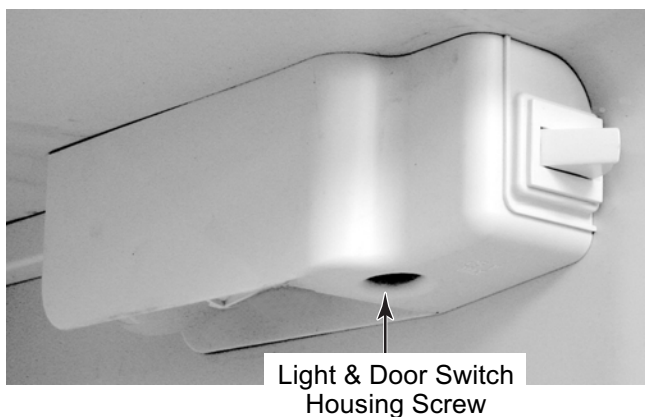

4. To remove the top compartment light socket:

- a) Remove the insulation from the housing.

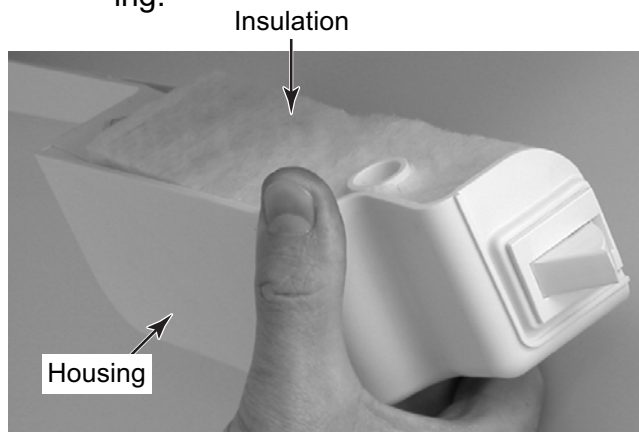

- b) Press on the locking tab and push the socket out of the housing cutout.

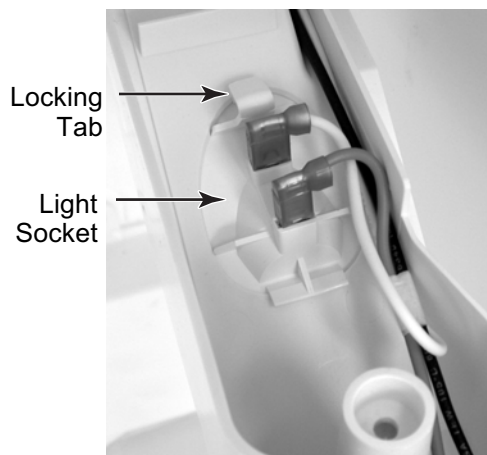

- c) Remove the light bulb from the socket.
- d) Disconnect the wires from the light socket terminals.

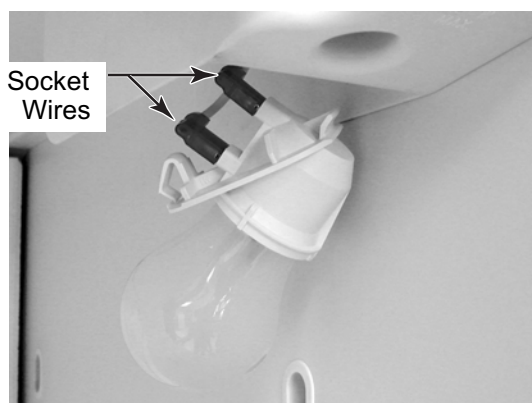

5. **To remove the door switch:**

- a) Disconnect the wires from the door switch terminals.
- b) Press down on the locking tab and push the switch out of the housing cutout.

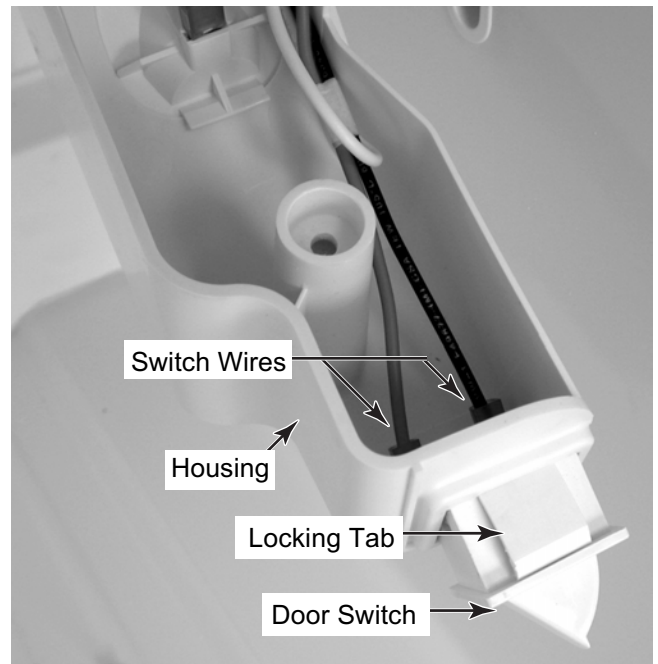

# REMOVING THE EVAPORATOR FAN MOTOR, LINER HEATER BIMETAL & DEFROST BIMETAL, DEFROST HEATER, AND EVAPORATOR

## ! WARNING



**Electrical Shock Hazard**  
**Disconnect power before servicing.**  
**Replace all parts and panels before operating.**  
**Failure to do so can result in death or electrical shock.**

1. Unplug refrigerator or disconnect power.
2. Remove the outer evaporator cover (see steps 2 through 7 on page 3-2 for the procedure).
3. Lift the front of the top compartment floor and pull it out of the unit.



4. Lift and pull the drain pan at a 45° angle and remove it from the unit.
5. Pull the styrofoam evaporator cover separator out and remove it from the unit.

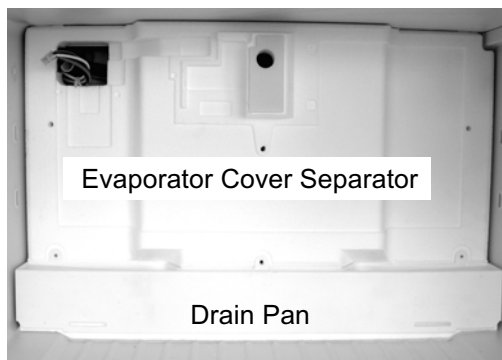

6. Remove the two screws from the air tower.
7. Pull the top of the evaporator cover forward, and lift the bottom of the tower out of the air supply opening.

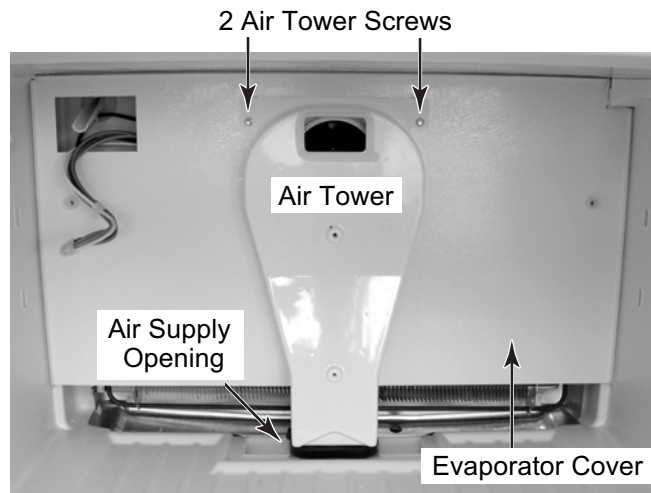

8. **To remove the evaporator fan motor:**
  - a) Disconnect the 2-wire defrost heater connector, the 2-wire top compartment light connector, and the 9-wire liner connector.
  - b) Pull the liner heater bimetal and the defrost bimetal off the tubing.
  - c) Remove the wiring from the evaporator fan motor housing clips.

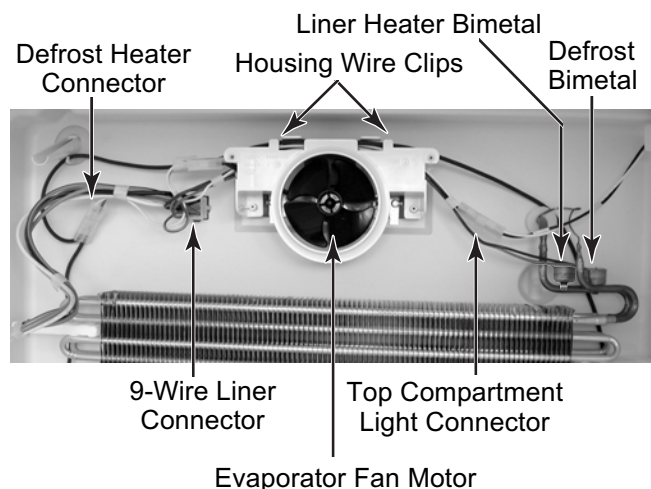

- d) Remove the four hex-head rear bracket screws from the evaporator fan motor housing and remove the motor.

4 Evap Fan Motor Rear Bracket Screws



- e) Remove the green ground wire connector from the motor ground terminal.  
 f) Disconnect the 2-wire motor connector.  
 g) Pull the blade off the fan motor shaft.

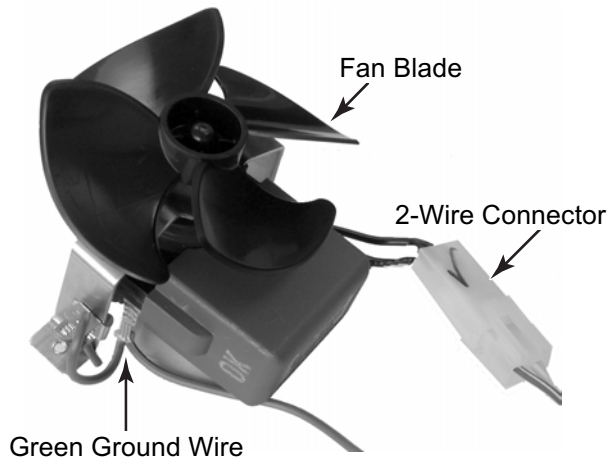

- h) Pull the front bracket off the fan motor.

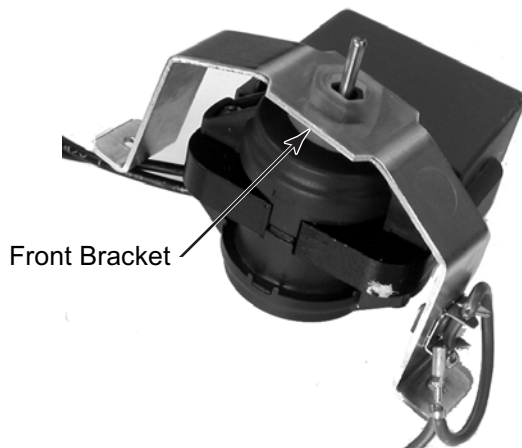

9. **To remove either the liner heater bimetal or the defrost bimetal:**

- a) Pull the bimetal off the tubing.  
 b) Follow the instructions that were supplied with the replacement bimetal to connect the wires.

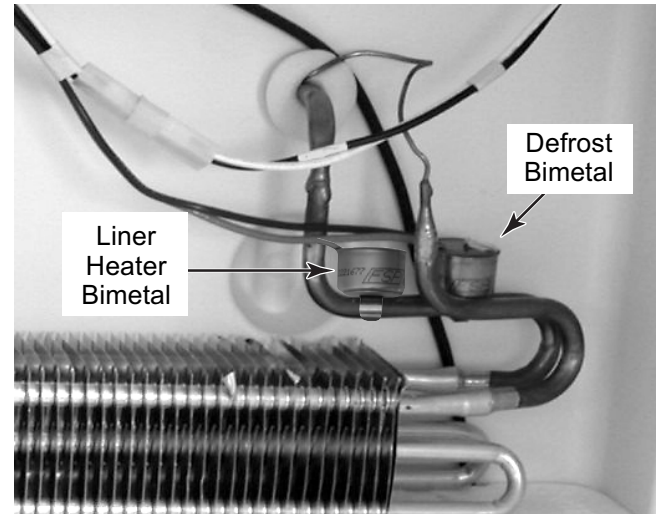

10. **To remove the defrost heater:**

- a) Disconnect the 2-wire defrost heater connector from the main harness.  
 b) Unclip the defrost heater wire from the top of the evaporator fan motor housing clips.  
 c) Pull the two styrofoam blocks from the left and right sides of the evaporator.

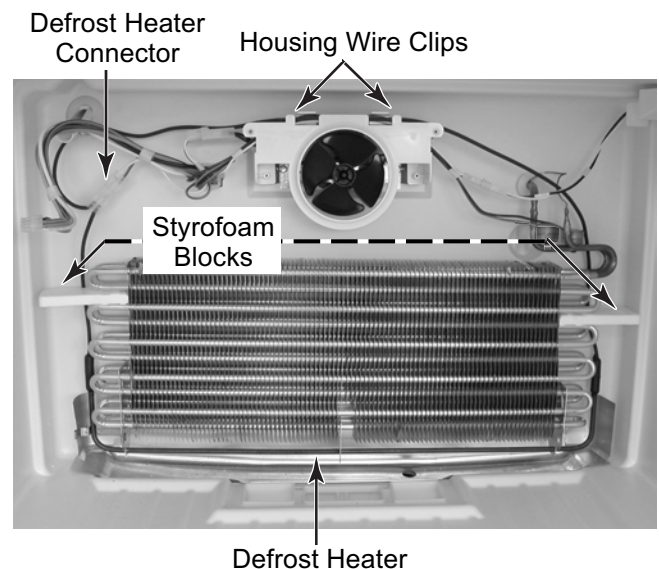

Continued on the next page.

- d) Bend the left, center, and right bottom bracket tabs so that you can remove the defrost heater.
- e) Unclip the bottom left side of the defrost heater, pull the heater from the three brackets, and remove the heater from the unit.

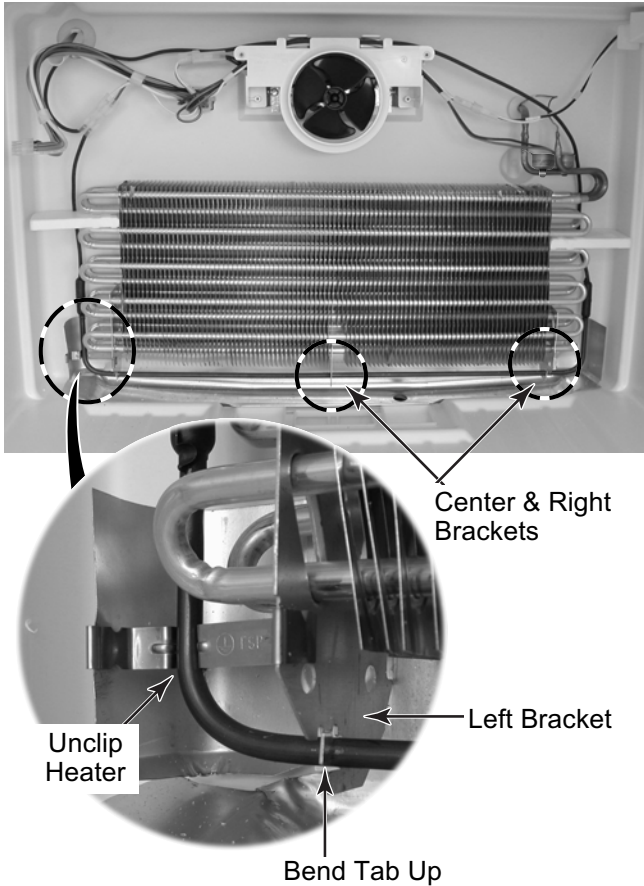

**11. To remove the evaporator:**

- a) Remove the defrost heater (see step 10 for the procedure).
- b) Unclip the bimetals from the evaporator tubing (see the photo under step 8c).
- c) Access the sealed system and discharge the refrigerant into an approved recovery system.
- d) Protect the liner back wall and ceiling, and then unbraid the tubing and remove and replace the evaporator.

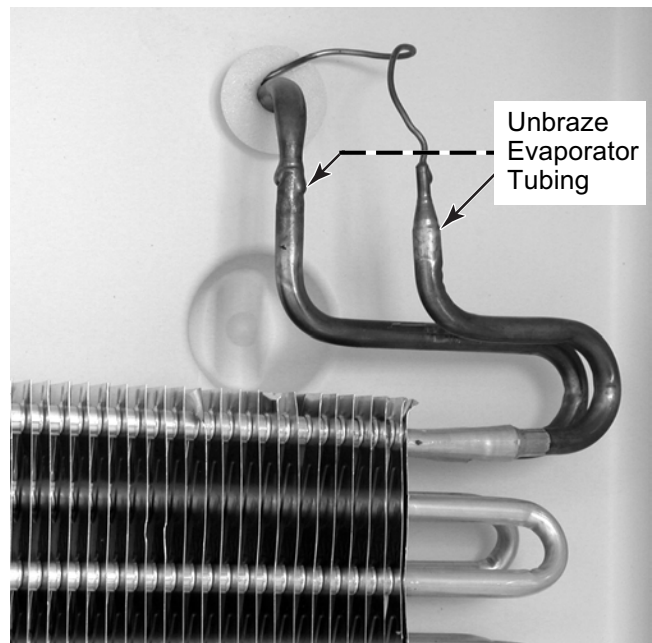

# REMOVING THE BOTTOM COMPARTMENT THERMOSTAT, DEFROST CONTROL, LIGHT SOCKET, AND DOOR SWITCH

## ⚠️ WARNING



**Electrical Shock Hazard**  
Disconnect power before servicing.  
Replace all parts and panels before operating.  
Failure to do so can result in death or electrical shock.

1. Unplug refrigerator or disconnect power.
2. Open the bottom compartment door and remove the items from the top shelf so you can access the control housing.



3. Remove the screw from the bottom compartment control housing and lower the housing.

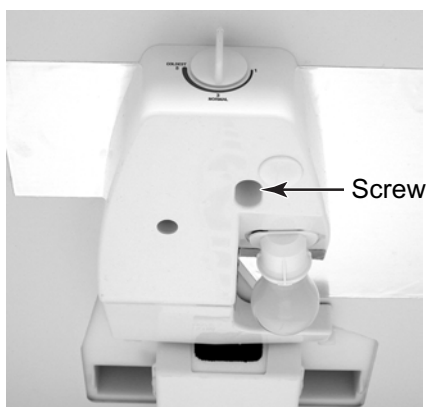

4. Disconnect the 2-wire and 9-wire control housing connectors and remove the control housing from the unit. Place the housing on a work surface with the component side facing up.

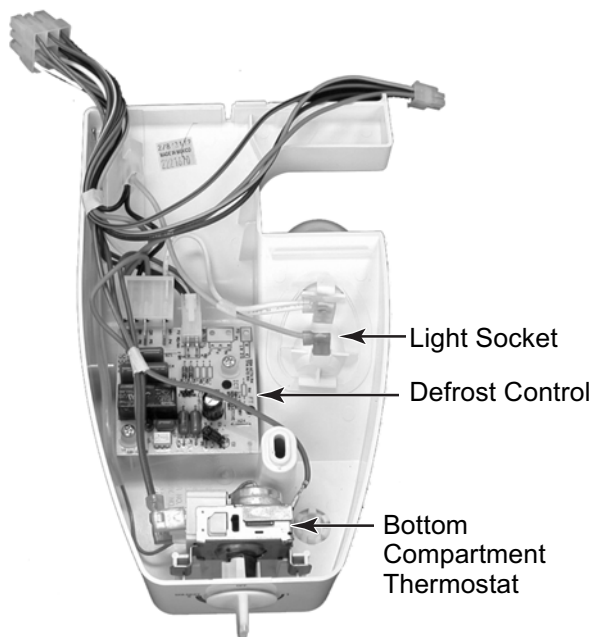
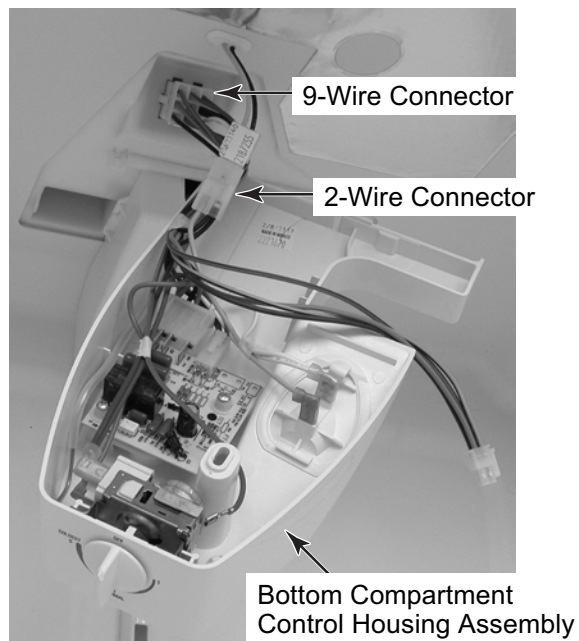

**Continued on the next page.**

5. **To remove the bottom compartment thermostat:**

- a) Pull the knob off the shaft.
- b) Disconnect the three wire connectors from the thermostat terminals.
- c) Lift the thermostat out of the housing and unclip the sensing bulb.

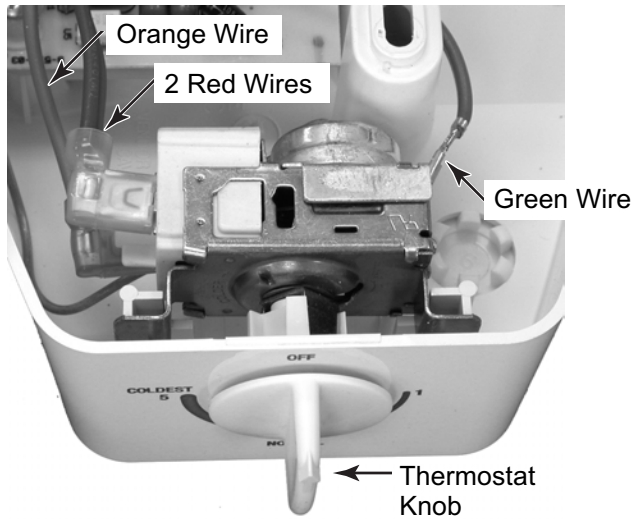

6. **To remove the defrost control:**

- a) Disconnect the two wire connectors from the defrost control terminals.
- b) Remove the 2 mounting screws from the defrost control.

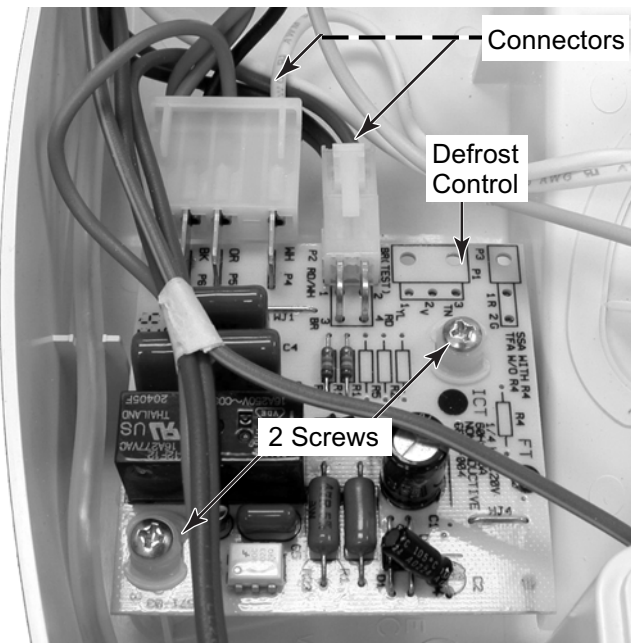

7. **To remove the light socket:**

- a) Disconnect the 2 wire connectors from the light socket terminals.
- b) Press on the locking tab and push the socket out of the housing cutout.
- c) Remove the light bulb from the socket.

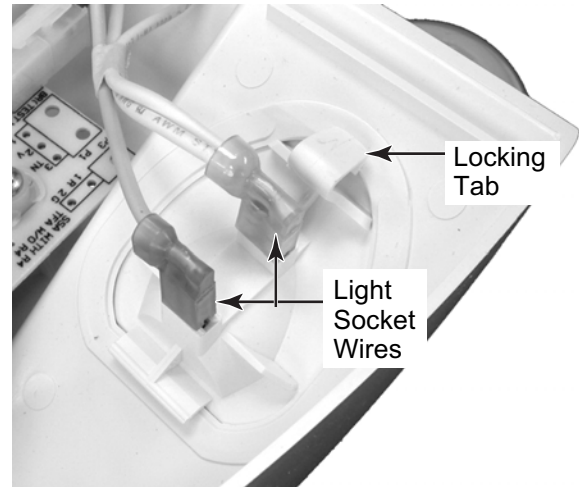

8. **To remove the door switch:**

- a) Using a small screwdriver, press up on the locking tab and pull the switch out of the liner cutout.
- b) Disconnect the two wires from the door switch terminals.

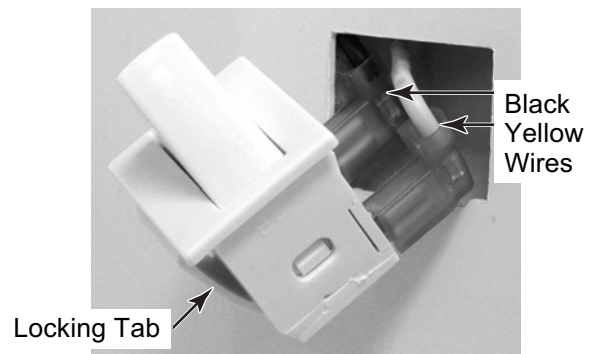
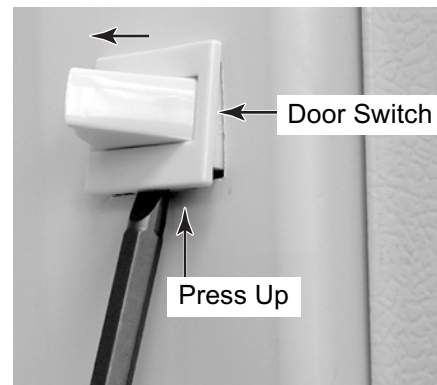



## REMOVING THE CONDENSER FAN MOTOR AND AMBIENT BIMETAL

### **!WARNING**



**Electrical Shock Hazard**  
**Disconnect power before servicing.**  
**Replace all parts and panels before operating.**  
**Failure to do so can result in death or electrical shock.**

1. Unplug refrigerator or disconnect power.
2. Pull the refrigerator away from the wall.
3. At the rear of the unit, remove the eight hex-head screws from the unit compartment cover and remove the cover. NOTE: When installing the unit compartment cover, be sure to hook the lip at the bottom into the machine base.

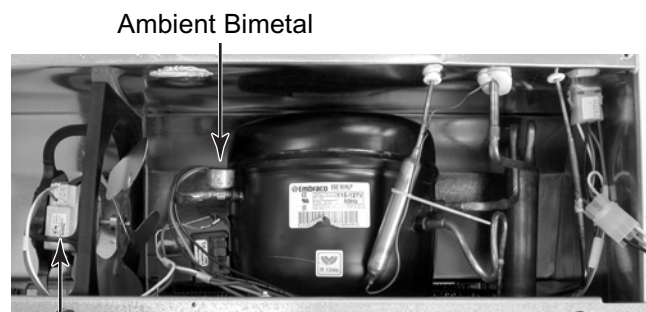

Condenser Fan Motor

4. To remove the condenser fan motor:
  - a) Remove the speed nut from the fan blade and remove the blade.

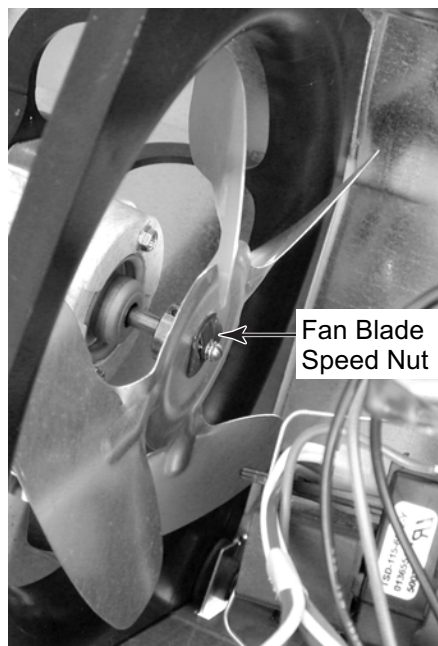

- b) Remove the 2 hex-head screws from the condenser fan motor and remove the motor from the bracket.

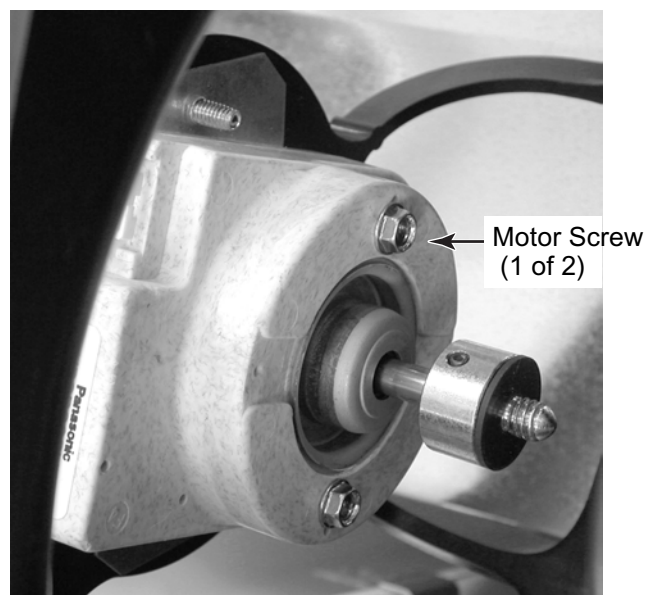

**Continued on the next page.**

- c) Disconnect the wire connector from the motor.

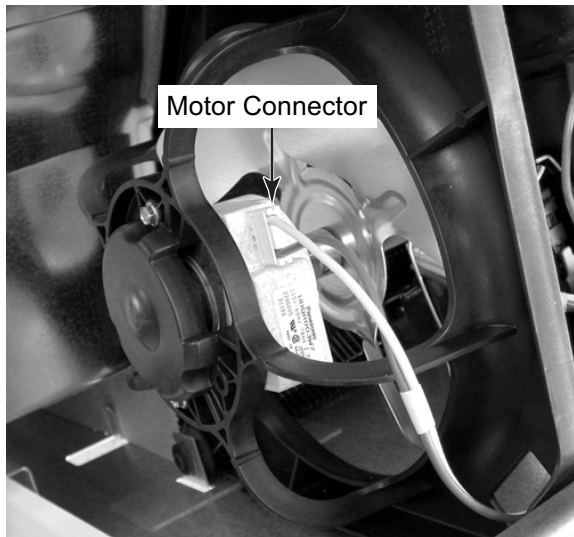

5. **To remove the ambient bimetal:**

- a) Unclip the bimetal from the compressor process stub. NOTE: When reinstalling the bimetal on the process stub, keep the bimetal as close to the compressor as possible.
- b) Follow the instructions supplied with the replacement bimetal to connect it to the unit.

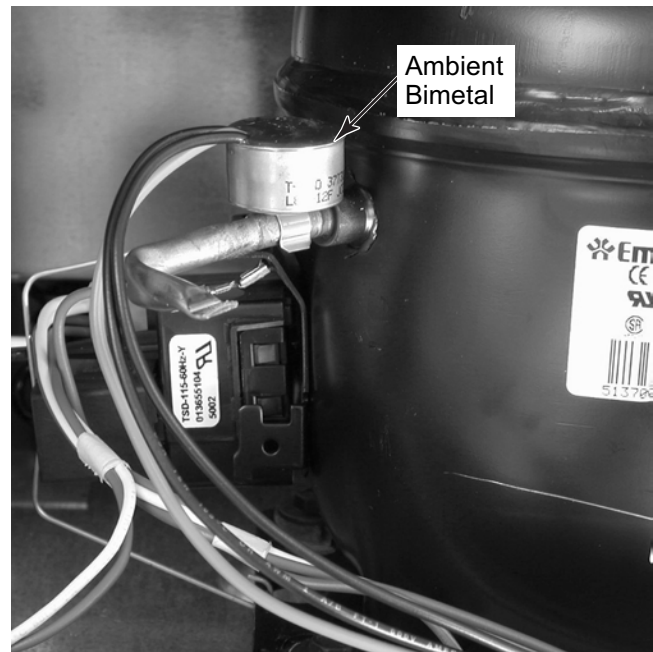

# REMOVING THE RELAY/OVERLOAD AND RUN CAPACITOR ASSEMBLY AND THE COMPRESSOR

## ! WARNING



**Electrical Shock Hazard**  
**Disconnect power before servicing.**  
**Replace all parts and panels before operating.**  
**Failure to do so can result in death or electrical shock.**

1. Unplug refrigerator or disconnect power.
2. Pull the refrigerator away from the wall.
3. Remove the unit compartment cover (see step 3 on page 3-13 for the procedure).
4. **To remove the relay/overload and run capacitor assembly from the compressor:**
  - a) Unclip the wire spring retainer from the relay/overload and run capacitor assembly and remove it.

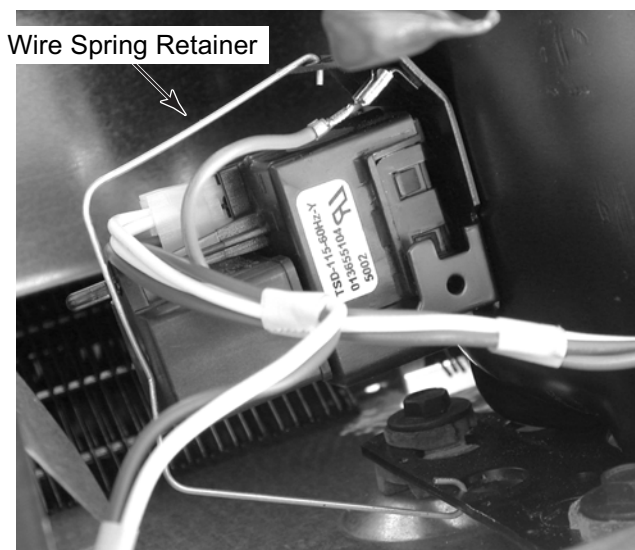

- b) Pull the relay/overload and run capacitor assembly from the compressor pins.
- c) Disconnect the 2-pin connector from the relay/overload and run capacitor assembly.

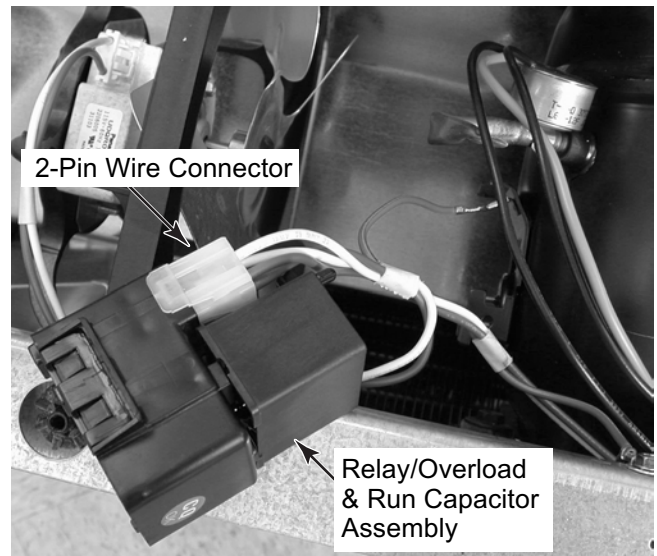

- d) Pull the run capacitor off the relay/overload.

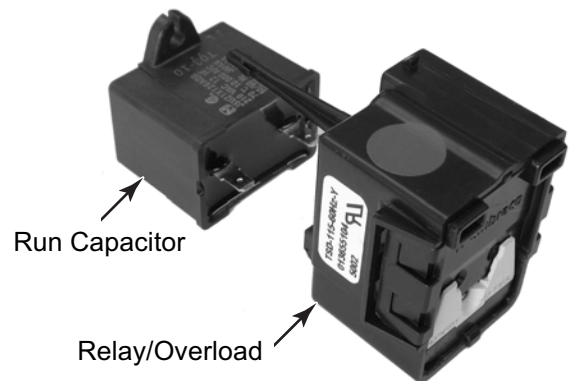

**Continued on the next page.**

5. **To remove the compressor:**

- a) Remove the relay/overload and run capacitor assembly from the compressor pins (see step 4).
- b) Access the sealed system and discharge the refrigerant into an approved recovery system.
- c) Unbraid the suction and discharge lines.
- d) Cut the filter/drier from the system (do not use a torch to remove the filter/drier).
- e) Remove the mounting screws from the compressor shock mounts and remove the compressor.

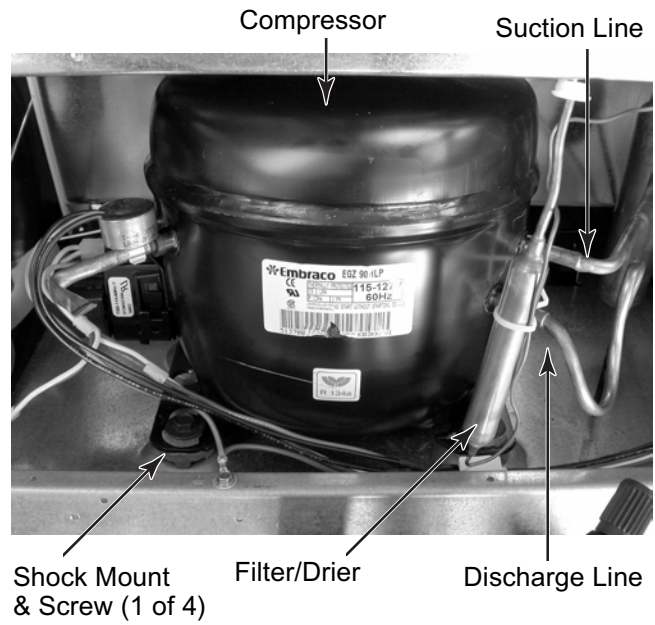

## REMOVING A CASTER

### **! WARNING**



**Electrical Shock Hazard**  
**Disconnect power before servicing.**  
**Replace all parts and panels before operating.**  
**Failure to do so can result in death or electrical shock.**

1. Unplug refrigerator or disconnect power.
2. Remove all of the items from inside the unit and remove the shelving.
3. Tape the doors closed.
4. Pull the refrigerator away from the wall.
5. Tip the unit on its side so that the caster you wish to access is facing away from the floor.



6. Remove the two 1/2" and two 3/8" bolts from the caster bracket and remove the caster assembly.

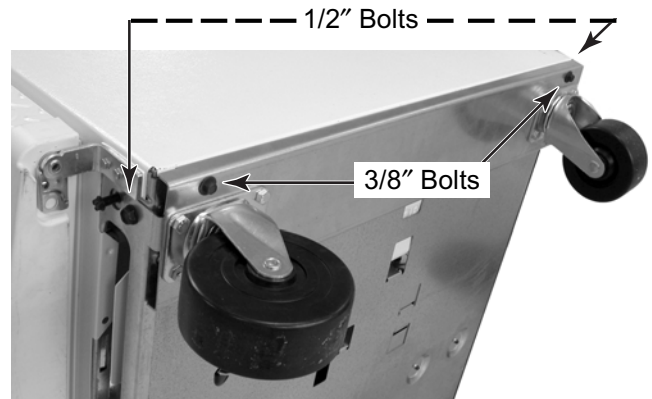

7. To remove a caster, remove the four bolts and locknuts.

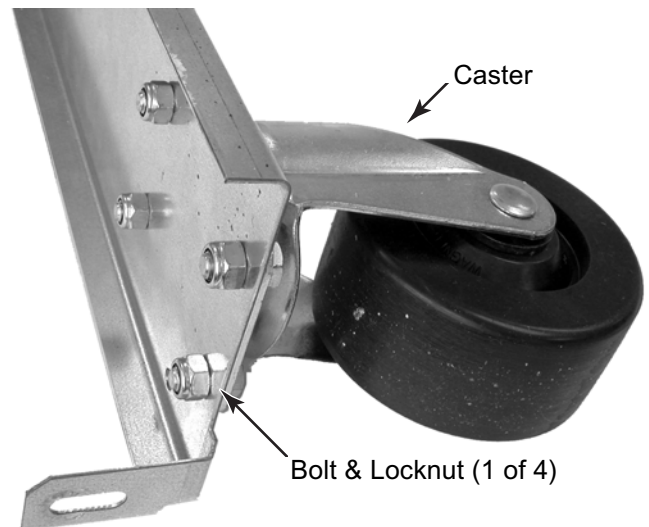

## REMOVING A ROLLER AND CONDENSER FAN MOTOR HOUSING

### **! WARNING**



**Electrical Shock Hazard**  
Disconnect power before servicing.  
Replace all parts and panels before  
operating.  
Failure to do so can result in death or  
electrical shock.

1. Unplug refrigerator or disconnect power.
2. Remove all of the items from inside the unit and remove the shelving.
3. Pull the refrigerator away from the wall.
4. **If you are removing a front roller only**, open the bottom compartment door, and remove the grille.

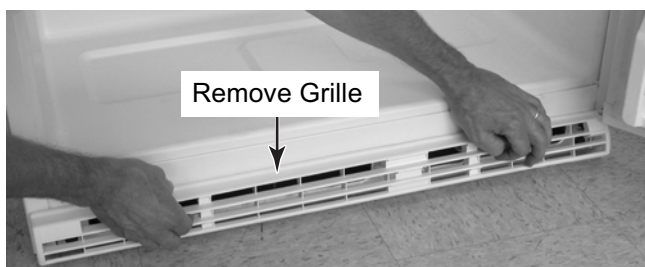

5. Tape the doors closed.
6. Tip the unit on its side so that the roller you wish to access is facing away from the floor.

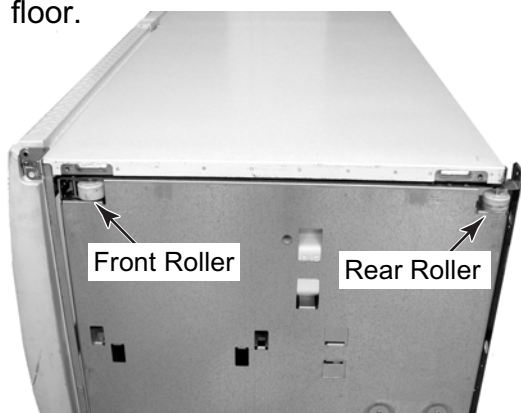

7. To remove a rear roller:
  - a) Remove the 1/2" and two 3/8" bolts from the rear of the unit.

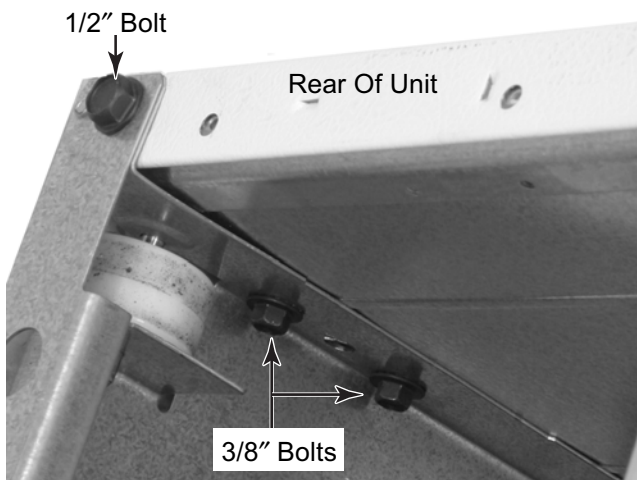

- b) Lower the rear corner of the base until the round head of the axle pin is below the bottom edge of the cabinet.
- c) Pull the axle pin from the roller and remove the roller from the base.

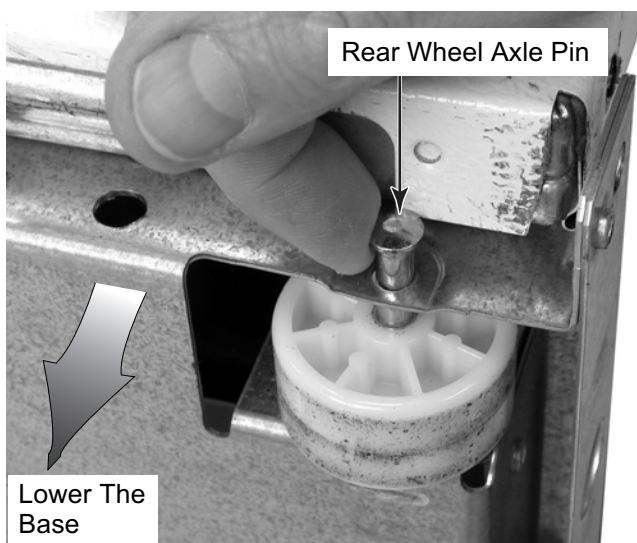

8. **To remove a front roller:**

- a) Remove the 1/2" and two 3/8" bolts from the rear of the unit on each side (see the photo in step 7a).
- b) Remove the 1/2" bolt from the front of the unit on each side.



- c) Slide the base to the rear of the unit approximately 1" so that it clears the front lip of the unit.

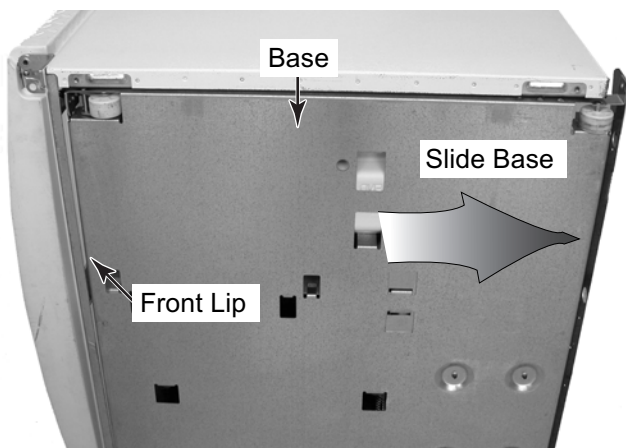

- d) Lower the front of the base until the round head of the axle pin is below the bottom edge of the cabinet.
- e) Pull the axle pin from the front roller and remove the roller from the base.



9. **To remove the condenser fan motor housing:**

- a) Slide the base to the rear of the unit approximately 1" so that it clears the front lip of the unit (see steps 8a through 8c for the procedure).
- b) Disconnect the condenser fan motor wiring connector and pull the wires through the housing cutout.

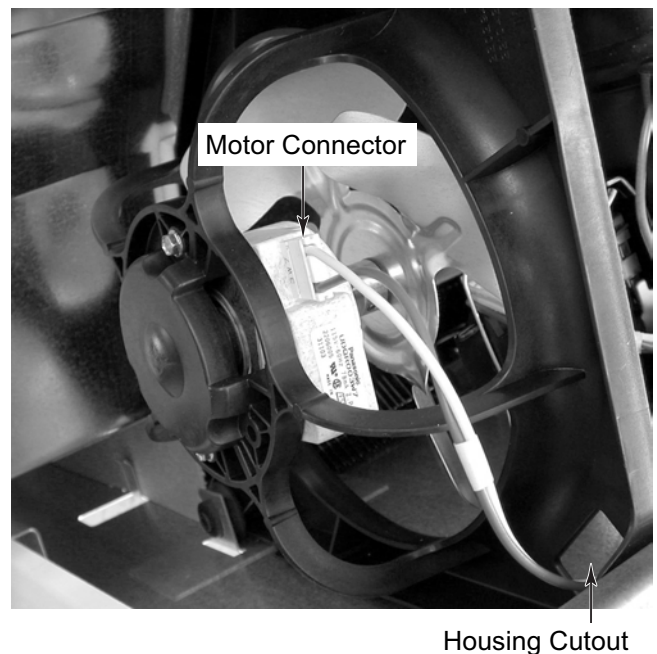

**Continued on the next page.**

- c) Push the condenser fan motor housing towards the front of the unit until the pin is out of the base holder, then tilt the top of the housing, and remove it from the unit.

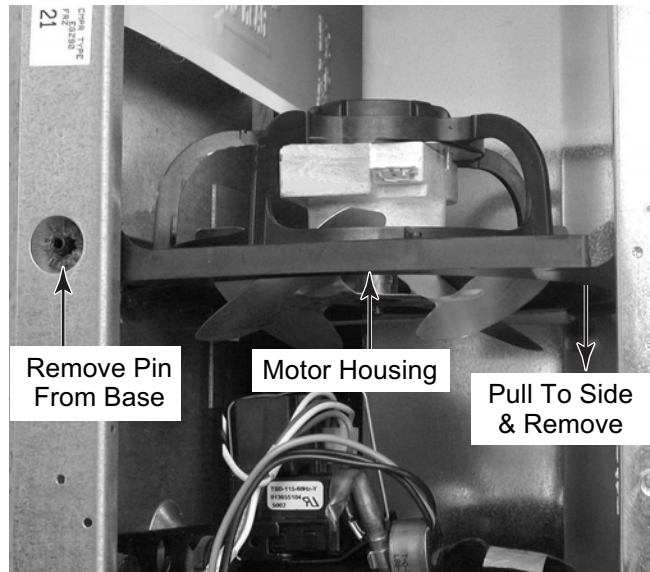



# COMPONENT TESTING

Before testing any of the components, perform the following checks:

- Control failure can be the result of corrosion on connectors. Therefore, disconnecting and reconnecting wires will be necessary throughout test procedures.
- All tests/checks should be made with a VOM or DVM having a sensitivity of 20,000 ohms-per-volt DC, or greater.
- Check all connections before replacing components, looking for broken or loose wires, failed terminals, or wires not pressed into connectors far enough.
- Resistance checks must be made with power cord unplugged from outlet, and with wiring harness or connectors disconnected.

	<b>⚠ WARNING</b>
	<b>Electrical Shock Hazard</b> <b>Disconnect power before servicing.</b> <b>Replace all parts and panels before operating.</b> <b>Failure to do so can result in death or electrical shock.</b>

## TOP COMPARTMENT THERMOSTAT & FREEZER/REFRIGERATOR SELECTOR SWITCH

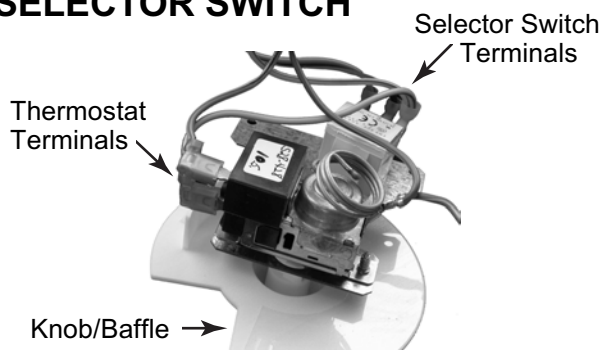

Refer to page 3-2 for the procedure for servicing the top compartment thermostat & freezer/refrigerator selector switch.

1. Unplug refrigerator or disconnect power.
2. Set the ohmmeter to the R x 1 scale.
3. Disconnect the wires from the thermostat terminals.
4. Clip the ohmmeter test leads to the thermostat terminals and turn the knob/baffle. The meter should switch between continuity ( $0 \Omega$ ) and an open circuit (infinite) at the trip setting.
5. Disconnect the wires from the freezer/refrigerator selector switch terminals.
6. Turn the knob/baffle until the button on the freezer/refrigerator selector switch is out.
7. Touch the ohmmeter test leads to the COM and N.C. selector switch terminals. The meter should indicate continuity ( $0 \Omega$ ).
8. Turn the knob/baffle until the button on the freezer/refrigerator selector switch is in. The meter should indicate an open circuit (infinite).
9. Touch the ohmmeter test leads to the COM and N.O. selector switch terminals. With the button pressed in, the meter should indicate continuity ( $0 \Omega$ ).
10. Turn the knob/baffle until the button on the freezer/refrigerator selector switch is out. The meter should indicate an open circuit (infinite).



## ⚠ WARNING

### Electrical Shock Hazard

Disconnect power before servicing.

Replace all parts and panels before operating.

Failure to do so can result in death or electrical shock.

## DEFROST BIMETAL & DEFROST HEATER



Refer to page 3-8 for the procedure for servicing the defrost bimetal and defrost heater.

1. Place the unit into the “Adaptive Defrost Control Test Mode,” and check for the proper operation of the heater.

NOTE: If the bimetal is closed, the voltage at the defrost heater terminals will be 120 volts AC. The remaining steps will allow you to check the resistance of the defrost heater and bimetal.

2. Unplug refrigerator or disconnect power.
3. Lower the bottom compartment control housing to access the bimetal and heater test points (see page 3-11).

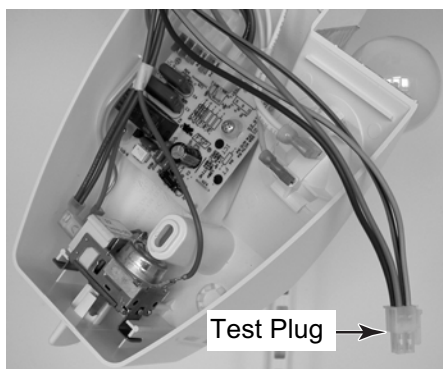

4. Set the ohmmeter to the R x 1 scale.

5. To test the defrost bimetal:

- a) Touch the ohmmeter test leads to the test plug pins with the pink and brown wires.

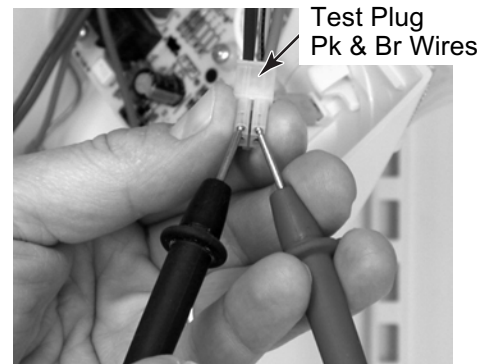

- b) With the bimetal below 20°F (−6.6°C), the meter should indicate continuity (0 Ω).
- c) With the bimetal above 50°F (10°C), the meter should indicate an open circuit (infinite).

6. To test the defrost heater:

- a) Touch one of the ohmmeter test leads to the white wire on the 9-pin connector.

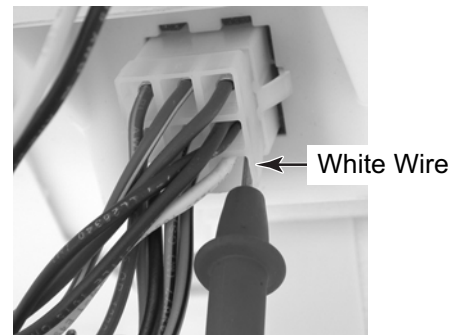

- b) Touch the other ohmmeter test lead to the test plug pin with the brown wire.
- c) The meter should indicate between 31 and 42 Ω.



## ⚠️ WARNING

### Electrical Shock Hazard

Disconnect power before servicing.

Replace all parts and panels before operating.

Failure to do so can result in death or electrical shock.

### AUXILIARY HEATER

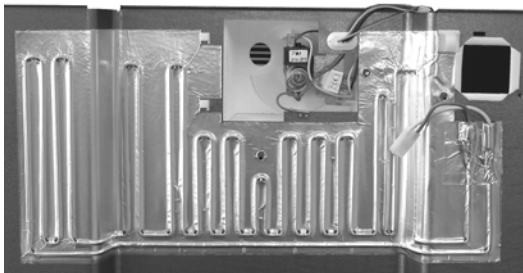

Refer to page 3-5 for the procedure for servicing the auxiliary heater.

1. Unplug refrigerator or disconnect power.
2. Set the ohmmeter to the R x 10 scale.
3. Touch one of the ohmmeter test leads to the test plug pin with the light blue wire with the black stripe.

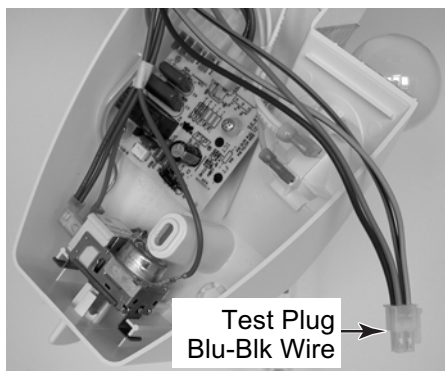

4. Touch the other ohmmeter test lead to the white wire on the 9-pin connector (see step 6 on page 4-2).
5. The meter should indicate between 180 and 360  $\Omega$ .

### LINER HEATER

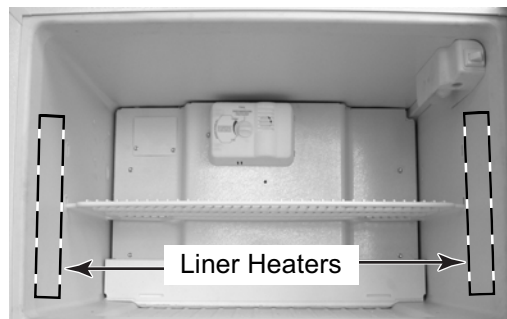

1. To check the liner heater, unplug refrigerator or disconnect power.
2. Set the ohmmeter to the R x 10 scale.
3. Touch one of the ohmmeter test leads to the test plug pin with the orange wire with the black stripe.

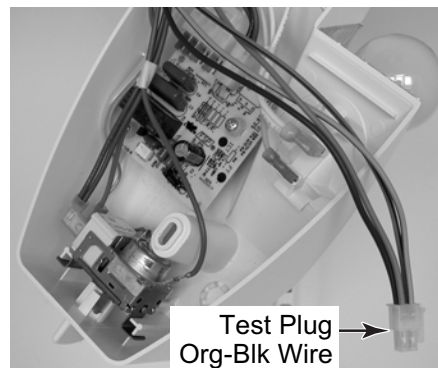

4. Touch the other ohmmeter test lead to the white wire on the 9-pin connector (see step 6 on page 4-2).
5. The meter should indicate between 706 and 923  $\Omega$ .



## ! WARNING

### Electrical Shock Hazard

**Disconnect power before servicing.**

**Replace all parts and panels before operating.**

**Failure to do so can result in death or electrical shock.**

### LINER HEATER BIMETAL



Refer to page 3-8 for the procedure for servicing the liner heater bimetal.

1. Unplug refrigerator or disconnect power.
2. Set the ohmmeter to the R x 1 scale.
3. Touch the ohmmeter test leads to the YL/ RD and GY bimetal wires .
4. With the bimetal below 25°F (−4°C), the meter should indicate continuity (0 Ω).

With the bimetal above 40°F (4°C), the meter should indicate an open circuit (infinite).

### AMBIENT BIMETAL



Refer to page 3-13 for the procedure for servicing the ambient bimetal.

1. Unplug refrigerator or disconnect power.
2. Set the ohmmeter to the R x 10 scale.
3. Disconnect the 9-pin cabinet connector in the top of the unit compartment.
4. Touch the ohmmeter test leads to pins 5 and 6.

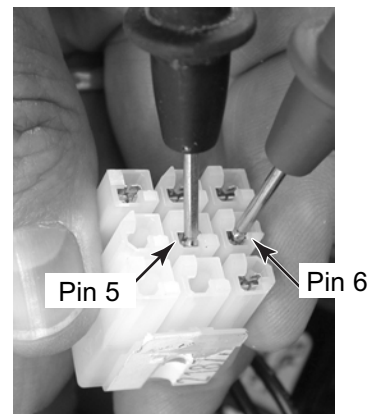

5. If the bimetal is below 76°F (24°C), the meter should indicate continuity (0 Ω).

With the bimetal above 88°F (31°C), the meter should indicate an open circuit (infinite).



## ⚠ WARNING

### Electrical Shock Hazard

**Disconnect power before servicing.**

**Replace all parts and panels before operating.**

**Failure to do so can result in death or electrical shock.**

### BOTTOM COMPARTMENT THERMOSTAT



Refer to page 3-11 for the procedure for servicing the bottom compartment thermostat.

1. Unplug refrigerator or disconnect power.
2. Set the ohmmeter to the R x 1 scale.
3. Disconnect the wires from the thermostat terminals.
4. Clip the ohmmeter test leads to the thermostat terminals and turn the control shaft.
5. The meter should switch between continuity ( $0 \Omega$ ) and an open circuit (infinite) at the trip setting.

### DOOR SWITCH



Refer to pages 3-6 and 3-11 for the procedures for servicing a door switch.

1. Unplug refrigerator or disconnect power.
2. Disconnect one of the wires going to the door switch.
3. Set the ohmmeter to the R x 1 scale.
4. Touch the ohmmeter test leads to the COM and N.C. door switch terminals. The meter should indicate continuity ( $0 \Omega$ ).
5. Press the door switch actuator button and the meter should indicate an open circuit (infinite).



## ⚠️ WARNING

### Electrical Shock Hazard

**Disconnect power before servicing.**

**Replace all parts and panels before operating.**

**Failure to do so can result in death or electrical shock.**

## RELAY/OVERLOAD & RUN CAPACITOR



Refer to page 3-15 for the procedure for servicing the relay/overload & run capacitor.

1. Unplug refrigerator or disconnect power.
2. Set the ohmmeter to the R x 10K scale.
3. Remove the relay/overload and run capacitor assembly from the compressor pins.
4. Pull the run capacitor off the relay/overload.
5. **To test the run capacitor**, touch the ohmmeter test leads to the run capacitor terminals. The meter should indicate several ohms and gradually return to infinity.
6. **To test the overload**, touch the ohmmeter test leads to the center (C) terminal, and the terminal where the red wire is connected to the relay. The meter should indicate continuity (0  $\Omega$ ).
7. **To test the relay**, touch the ohmmeter test leads to the (M) and (S) terminals. The meter should indicate continuity (0  $\Omega$ ).

## COMPRESSOR

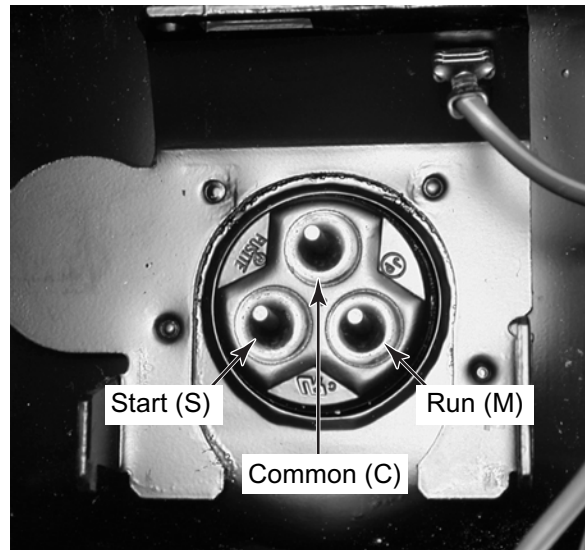

Refer to page 3-15 for the procedure for servicing the compressor.

1. Unplug refrigerator or disconnect power.
2. Set the ohmmeter to the R x 1 scale.
3. Remove the relay/overload and run capacitor assembly from the compressor pins.
4. Touch one of the ohmmeter test leads to the Common (C) pin, and the other lead to the Start (S) pin. The meter should indicate between 3 and 11  $\Omega$ .
5. Touch one of the ohmmeter test leads to the Common (C) pin, and the other lead to the Run (M) pin. The meter should indicate between 1 and 6  $\Omega$ .

# DIAGNOSTICS & TROUBLESHOOTING

## DIAGNOSTICS

### ADAPTIVE DEFROST CONTROL (ADC) TEST MODE

The refrigerator/freezer defrost system can be checked by manually initiating a defrost cycle. The following shows two methods for initiating the Adaptive Defrost Control (ADC) Test Mode.

#### Test Method #1

1. Turn the thermostat off for 15 seconds.
2. Turn the thermostat on for 5 seconds.
3. Turn the thermostat off for 15 seconds.
4. Turn the thermostat on for 5 seconds.
5. Turn the thermostat off for 15 seconds.
6. Turn the thermostat on for 5 seconds.
7. Turn the thermostat off.

The ADC should turn the defrost heater On within 3 to 8 seconds (with the bimetal closed).  
NOTE: The test mode will terminate when the bimetal opens.

If the refrigerator/freezer is already in defrost, the test mode can be terminated by unplugging the refrigerator/freezer from the wall outlet, waiting 30 seconds, and plugging it back in. The refrigerator/freezer should immediately go into the "cooling" mode if the thermostat is closed.

If this first test procedure fails to make the ADC initiate a defrost cycle, use the second test method to make the ADC begin the test mode.

#### Test Method #2

1. Disconnect the refrigerator/freezer from the wall outlet for at least 30 seconds.
2. Turn the bottom compartment thermostat Off.
3. Reconnect power to the refrigerator/freezer.

The ADC should turn the defrost heater On within 3 to 8 seconds (with the bimetal closed).

If the unit fails to go into the defrost mode during this test, the problem may not be with the ADC. A defective bimetal may be the cause of the failure. The ADC will only go into a test mode if the bimetal is closed. If the ADC senses an open bimetal, it will return to the cooling mode within 3 to 8 seconds.

HELPFUL HINT: Upon entering the test mode, the relay mounted on the ADC board should turn off the compressor, and turn on the defrost heater. Listen for the relay to click.

- If the relay clicks once when entering the test mode, check the defrost heater for 31 to 42  $\Omega$ .
- If the relay clicks twice, check for an open bimetal (allow up to 30 seconds between clicks).

# TROUBLESHOOTING CHART

Problem	Possible Cause	Test Procedure-Action
Convertible compartment too cold when set to refrigerate.	Open convertible compartment thermostat.	See "Component Testing" section for test procedure.
	Defective combination switch.	See "Component Testing" section for test procedure.
	Open 60 watt auxiliary heater.	See "Component Testing" section for test procedure.
	Baffle broken or leaking evaporator panel seal.	Repair/replace broken baffle or seal evaporator panel.
	Ambient bimetal not closing at 55°F (room temperature).	See "Component Testing" section for test procedure.
	Open liner heater bimetal.	See "Component Testing" section for test procedure.
	Convertible compartment thermostat set too low. Ambient temperature below 20°F.	Change to a higher setting.
Convertible compartment too warm when set to refrigerate. Lower compartment is normal.	Convertible compartment thermostat staying closed.	See "Component Testing" section for test procedure.
	Ambient bimetal closed above 65°F.	See "Component Testing" section for test procedure.
	Door not closing or damaged door gasket.	Adjust door or correct blockage. Replace damaged door gasket.
Both compartments too warm.	Controls set too warm.	Reposition controls to colder setting.
	Doors not closing or damaged door gaskets.	Adjust door or correct blockage. Replace damaged door gasket.
	Frost blocking the evaporator due to defective defrost bimetal, heater or electronic control.	See "Component Testing" section for test procedure.
	Defective evaporator fan motor.	See "Component Testing" section for test procedure.
	Defective condenser fan motor.	See "Component Testing" section for test procedure.
	Defective compressor, relay overload or run capacitor.	See "Component Testing" section for test procedure.
	Defective light switch.	See "Component Testing" section for test procedure.
	Refrigerant leak or restriction.	Repair sealed system.



# WIRING DIAGRAMS & STRIP CIRCUITS

## WIRING DIAGRAM 1

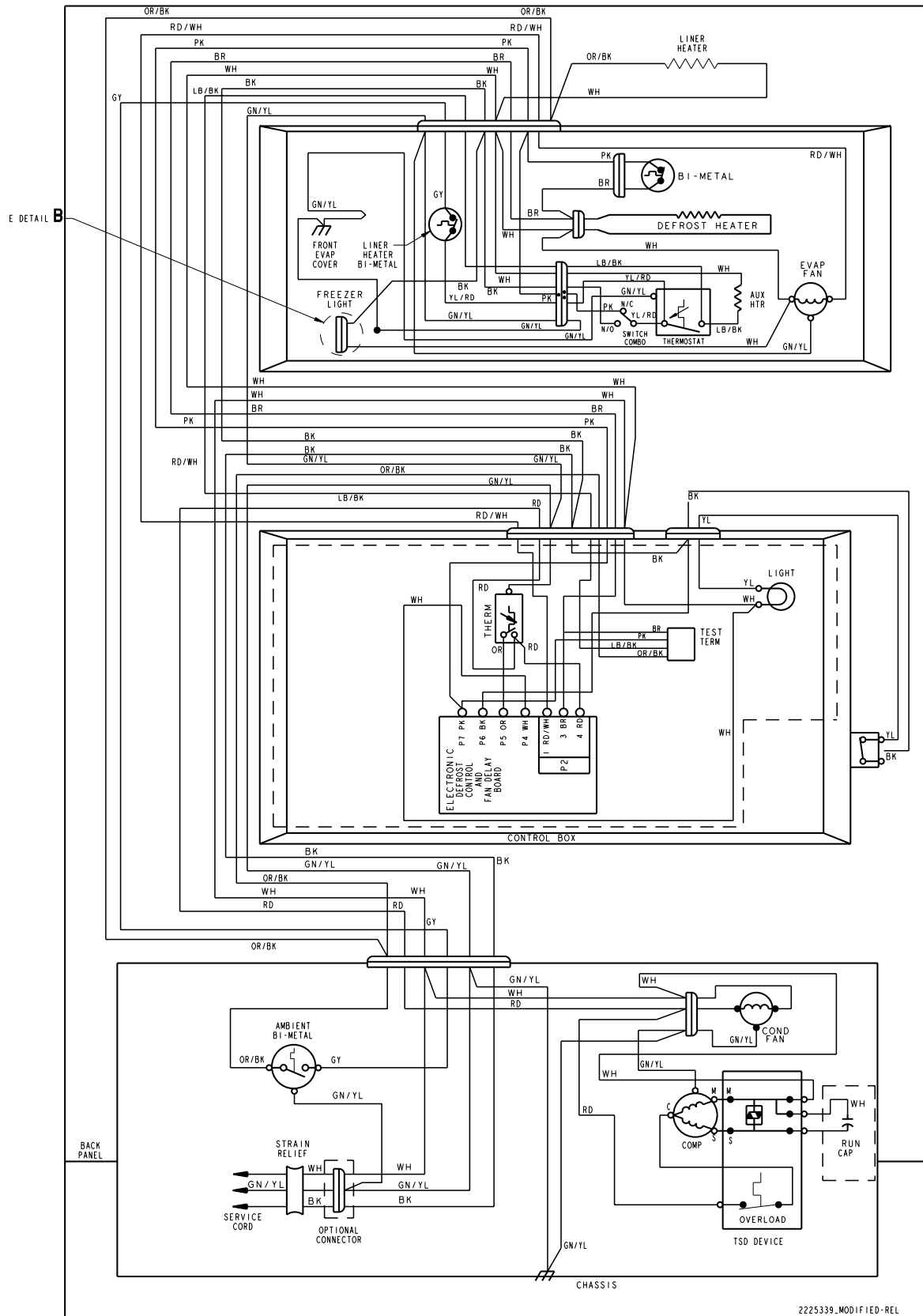

2225339\_MODIFIED-REL

# WIRING DIAGRAM 2

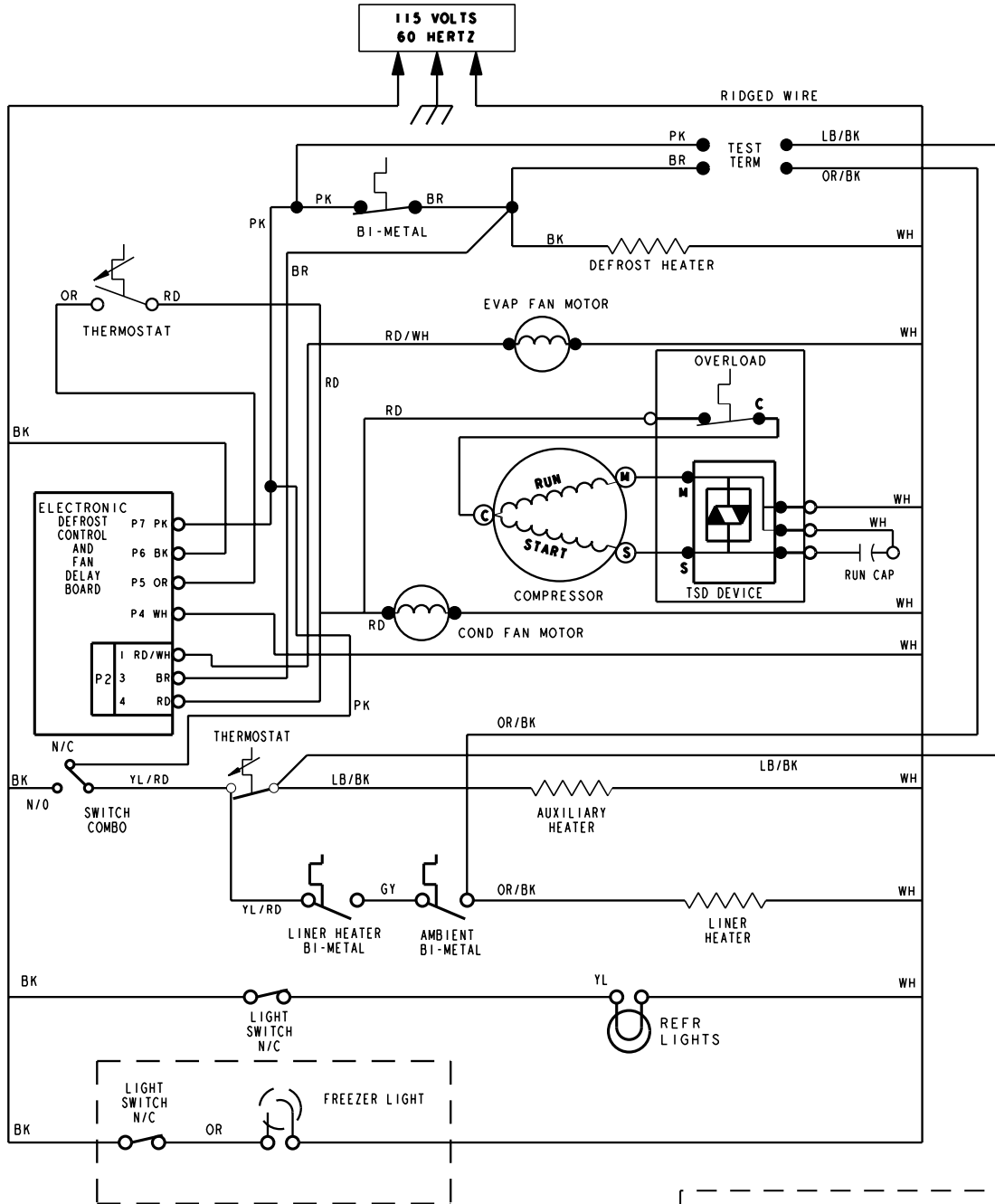

## SYMBOL CODE

- : CONNECTOR - SCREW ON
- : CONNECTOR - CLOSED END
- : DISCONNECT TERMINAL
- : PERMANENT CONNECTION
- : PLUG CONNECTOR
- ⏏ : GROUND (CHASSIS)

## WIRE COLOR CODE

- VI = VIOLET
- BU = BLUE
- BK = BLACK
- RD = RED
- WH = WHITE
- YL = YELLOW
- OR = ORANGE
- BR = BROWN
- GY = GRAY
- PK = PINK
- PU = PURPLE
- TN = TAN
- OR/BK = ORANGE/BLACK TRACER
- YL/RD = YELLOW/RED TRACER
- BU/BK = BLUE/BLACK TRACER
- WH/BU = WHITE/BLUE TRACER
- BK/YL = BLACK/YELLOW TRACER
- WH/RD = WHITE/RED TRACER
- GN/YL = GREEN/YELLOW TRACER
- BK/WH = BLACK/WHITE TRACER
- YL/BK = YELLOW/BLACK TRACER
- BK/RD = BLACK/RED TRACER
- RD/WH = RED/WHITE TRACER
- LB/BK = LIGHT BLUE/BLACK TRACER

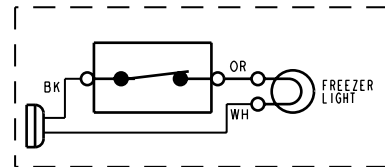

# STRIP CIRCUITS

## DEFROST (TOP COMPARTMENT TO REFRIGERATOR MODE)

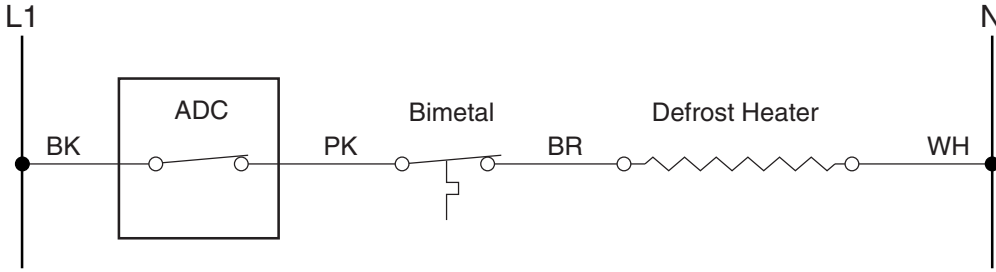

## DEFROST (TOP COMPARTMENT TO FREEZER MODE)

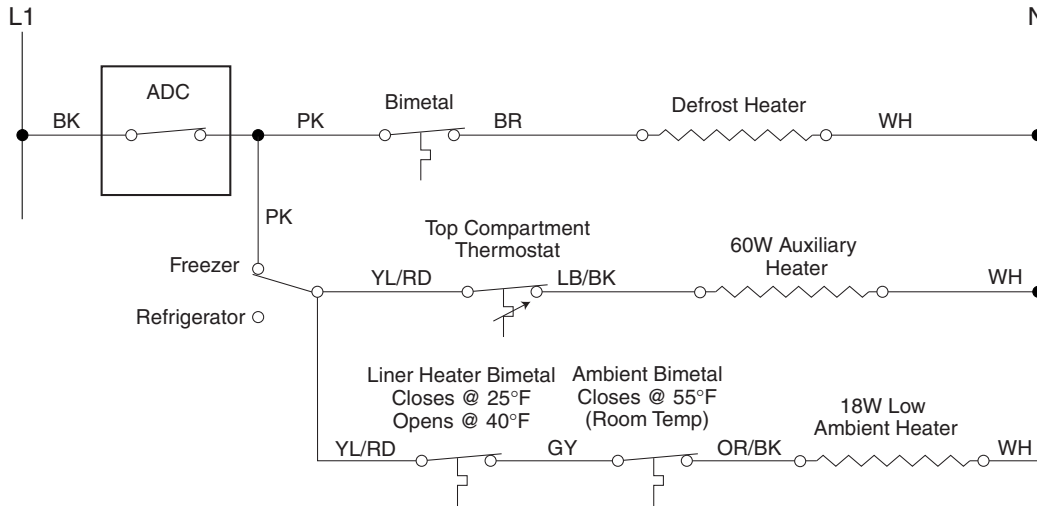

## AUXILIARY HEAT (TOP COMPARTMENT TO REFRIGERATOR MODE)

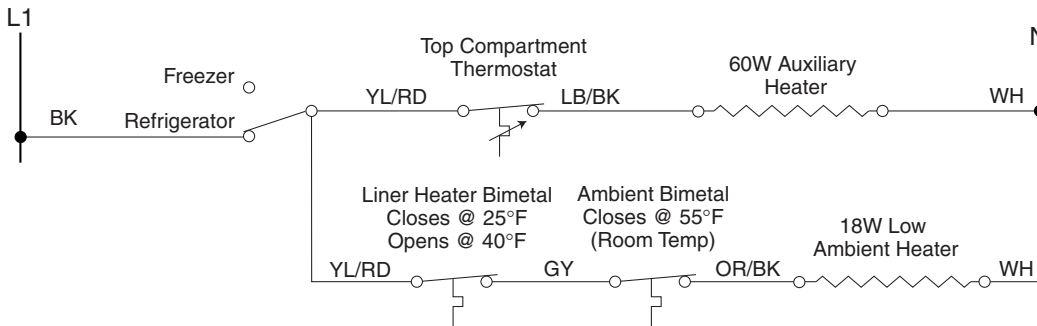

— NOTES —

— NOTES —

— NOTES —

# **PRODUCT SPECIFICATIONS AND WARRANTY INFORMATION SOURCES**

***IN THE UNITED STATES:***

**FOR PRODUCT SPECIFICATIONS AND WARRANTY INFORMATION CALL:**

FOR WHIRLPOOL PRODUCTS: 1-800-253-1301  
FOR KITCHENAID PRODUCTS: 1-800-422-1230  
FOR ROPER PRODUCTS: 1-800-447-6737

**FOR TECHNICAL ASSISTANCE WHILE AT THE CUSTOMER'S HOME CALL:**

THE TECHNICAL ASSISTANCE LINE: 1-800-253-2870

**HAVE YOUR STORE NUMBER READY TO IDENTIFY YOU AS AN  
AUTHORIZED SERVICER**

**FOR LITERATURE ORDERS:**

PHONE: 1-800-851-4605

**FOR TECHNICAL INFORMATION AND SERVICE POINTERS:**

[www.servicematters.com](http://www.servicematters.com)

---

***IN CANADA:***

**FOR PRODUCT SPECIFICATIONS AND WARRANTY INFORMATION CALL:**

1-800-461-5681

**FOR TECHNICAL ASSISTANCE WHILE AT THE CUSTOMER'S HOME CALL:**

THE TECHNICAL ASSISTANCE LINE: 1-800-488-4791

**HAVE YOUR STORE NUMBER READY TO IDENTIFY YOU AS AN  
AUTHORIZED SERVICER**

