

# Dishwasher Training/Repair Manual

- [Water valves..... 2](#)
- [Circulation pumps & impellers..... .4](#)
- [Control modules..... .9](#)
- [Heater assemblies & NTC's..... 13](#)
- [Drain pumps..... 19](#)
- [Dispensers..... 20](#)
- [Door latches..... 23](#)
- [Aqua sensors..... 24](#)
- [Water fill assemblies..... 25](#)
- [Miscellaneous service tips..... 26](#)
- [Quiz.....28](#)

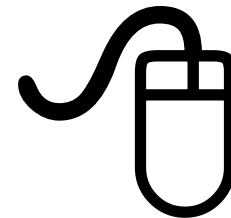

**NOTE:** Dishwashers are rated 120V, 60 Hz, 15A, 1450W (max.). Maximum amp draw when heaters running ~ 11A.



**Click onto any link to  
jump to that page**

# Part # 1 -- Water Valve (1)

## Disassembly

Access the water valve from the front of the dishwasher base by removing the toe kick.

### To remove water valve:

Tools needed: T20 Torx screwdriver & pliers.

1. Remove two (2) T-20 Torx screws from toe kick and tilt toe kick out from under dishwasher.
2. Remove base insulation (on models with insulation).
3. Move sump inlet hose away from water valve (without disconnecting it).
4. Disconnect wires from water valve, including ground wire.
5. Remove two (2) T-20 Torx screws from water valve.
6. Pull valve out from dishwasher and disconnect water hose from rear of valve. Remove any water from sump & base.

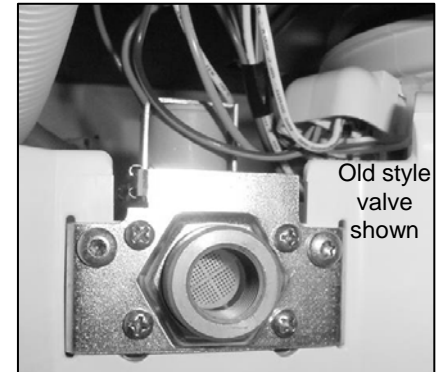

**CONNECTION HINTS:** Water connection 3/8" NPT female. Inlet water pressure range 5 - 120 psi (0.3 – 8.27 bars).

### *Removing toe kick*

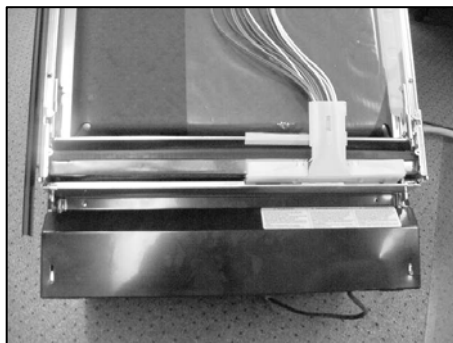

### *Moving sump hose*

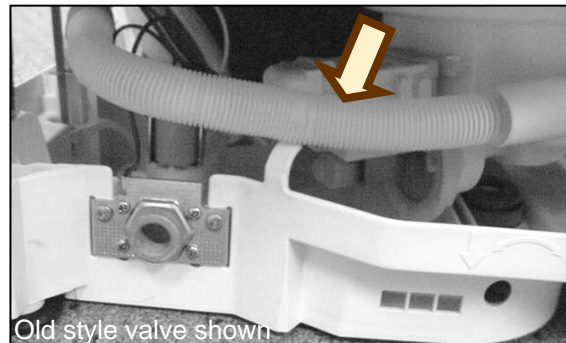

### *Removing hose clamp*



# Part # 1 -- Water Valve (2)

## Service Tips



**607335**  
"Rast 5"



**425458 &**  
**189533**



**580009**  
**(yellow**  
**stem) or**  
**167081**  
**(white stem)**

**NOTE:** Water valves have been upgraded several times since 1st 1/4 of 1999.

- **607335** "Rast 5" time-fill water valve (UC/43 & above dw's) has a keyed terminal connector and can't replace **425458** or **189533** valves. It replaces all "Rast 5" time-fill or pressure-fill valves.
- Time-fill valve # **425458** (UC/42 & below) also replaces pressure-fill valve # **189533**. It looks like pressure-fill valve # **189533**, but isn't the same. Pressure-fill valves can't replace time-fill valves.
- Pressure-fill valve (part # **189533**) has a horizontally mounted solenoid and water fitting held in place by the metal mounting bracket. It replaced older pressure-fill valves (**580009** & **167081**) until time-fill valve **425458** was used.

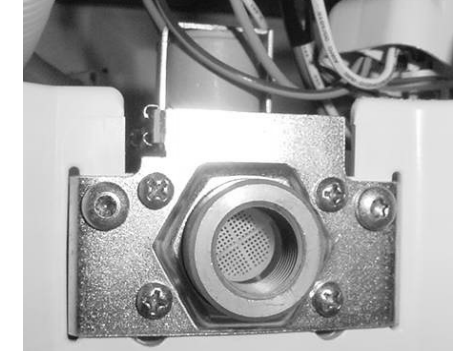

### HINTS:

- When reconnecting the water supply to the water valve, don't overtighten the elbow fitting. On valves with vertical solenoids, the plastic can crack and cause leaking if excessive force is used.
- Using Teflon tape on water fittings can help prevent leaking.
- The water valve can be accessed without removing outer door or base cover. However, removing them will provide easier access.

# Part # 2 -- Circulation Pump & Impeller (1)

## Access

The circulation pump & capacitor are accessed from the right side of the dishwasher by removing the right side panel and blocking the tank. Use same process to access heater & Apexx modules.

### To remove outer door:

*Tools needed: T20 Torx screwdriver.*

1. Remove six T-20 Torx inner door screws below fascia panel -- three per side (1).
2. Carefully pull bottom of outer door out from dishwasher until top door tabs clear, then pull door down until it releases from dishwasher (2). Take care to not scratch outer door.
3. Remove 1-piece foam or two plastic door guards (3). The plastic door guards occasionally fall out when the outer door is removed.

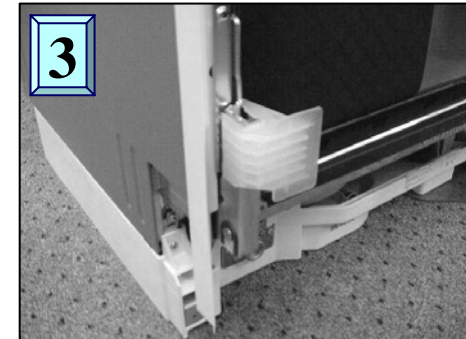

**NOTE:** Circulation pump 239144 motor is rated 120V, 60 Hz, 160W, insulation class A. Motor has an auto-reset thermal protector and uses a 10 $\mu$ F capacitor.

**HINT:** The fascia panel and door don't need to be removed to access the circulation pump. However, they must be removed to completely remove the tank.

# Part # 2 -- Circulation Pump & Impeller (2)

## To remove toe kick:

Tools needed: T20 Torx screwdriver.

1. Remove two T-20 Torx screws from toe kick (1).
2. Tilt toe kick out from under dishwasher (2).

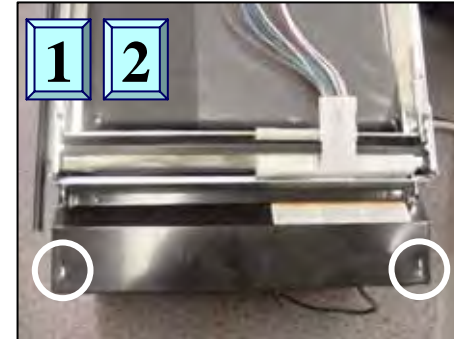

For models UC/36 & above, toe kicks screw directly into plastic bases using longer screws.

## To remove right & left side panels:

Tools needed: T20 Torx screwdriver.

Dishwashers may have long or short side panels, depending on model. Removing the left side panel isn't necessary for access, but allows the right side of the tank to be blocked upward.

1. For models with long side panels, remove two T-20 Torx side panel screws through holes in right & left trim strips (1).
2. To remove long side panels, lift panels with trim strips up and out from dishwasher (2).
3. To remove short side panels, remove two T-20 Torx screws (3). To avoid damaging trim strips (while blocking tanks), slide trim strips up until they clear dishwasher bases.



# Part # 2 -- Circulation Pump & Impeller (3)

## To raise right side of tank for circulation pump access:

Tools needed: T20 Torx screwdriver and pliers.

1. Remove one T-20 Torx screw from both rear corners holding tank to base (1) -- removing screw from both sides allows tank to be blocked upward.
2. Remove right toe kick bracket by removing T-20 Torx screw (2).
3. Remove T-20 Torx screws from front right bottom corner holding tank to base (3).
4. Remove right hinge cover (4a), release right door tension cord from hinge (4b) & remove ground wire (4c).
5. Raise and block up tank as shown with strut onto base (5a), sliding a piece of wood or other solid material between the tank and base to keep tank from falling back onto base (5b).

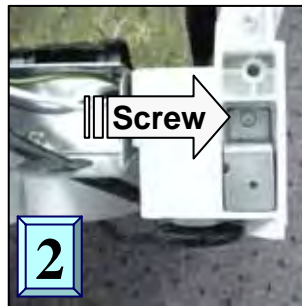

**CAUTION:** Don't turn dishwashers upside-down for tank access. When dishwashers are turned upside-down, water can flow into the water fill assembly diaphragm and cause water to not fill properly.



# Part # 2 -- Circulation Pump & Impeller (4)

## Disassembly

To remove motor to access impeller or change complete pump:

*Tools needed: flat blade screwdriver.*

1. Disconnect wire harness from motor after carefully noting connections (1).
2. For UC/11 & later models with softer bearing, lift up rubber straps from both sides of motor (2). For older models, lift motor up from base.
3. To release plastic latch on pump/motor housing (@ 2:30 position), carefully push onto latch with screwdriver (3).
4. To release motor from pump housing, twist motor to the right (clockwise). Some force may be required. Capacitor should be ~ 11:00 position (4). Pull motor out from pump housing.

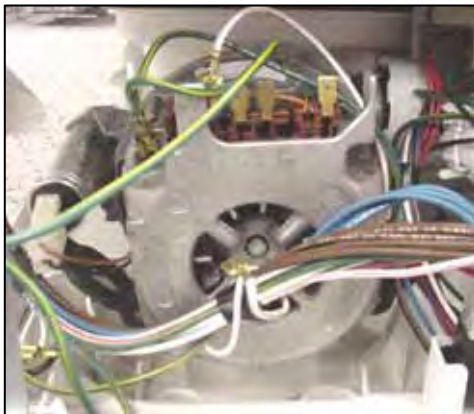

**HINT:** When replacing circulation pumps for softer bearing models (UC/11 & later), reusing existing front pump housings can save time by not changing hose clamps. If desired, order # **172272** hose clamps & replace entire pumps.

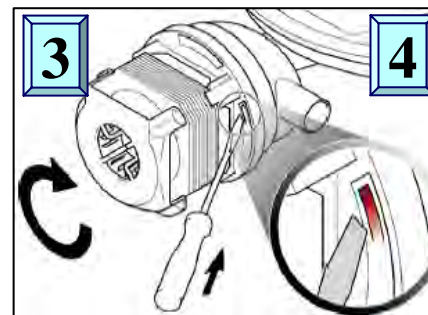
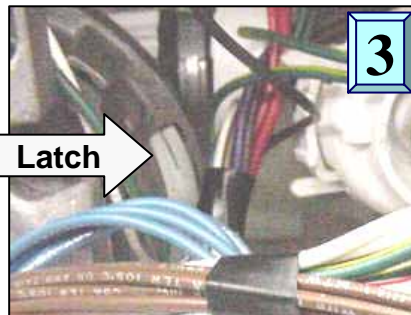
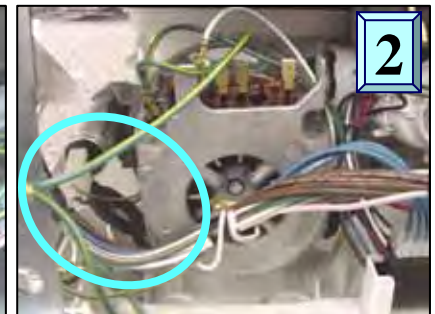

**CAUTION:** Don't grab motor next to the capacitor to avoid jamming your hand on the capacitor.

See page 8 for pump types.

# Service Tips -- Comparing Circulation Pump Versions

Depending on features, dishwashers have one of four types of circulation pumps. Pumps use different controls, wire harnesses, heaters & sump filters, so replace with identical replacement pumps.



## **# 665510 BLDC pump**

- Pump, motor and control come as one unit.
- Speed changes as needed for wash cycle and washability (*Vario wash*).
- Pump is isolated from motor, so no seal is needed and no need to loosen or replace impellers
- Used starting with UC/46 index.



## **# 239144 pump**

- Can buy # 266511 motor separately.
- Can use # 167085 impeller kit.



## **# 442548 ("Sicasym") pump**

- Most common pump. Used starting with UC/21 index. Smaller than 239144 pump.
- Used with control modules & single wire harnesses designed for Sicasym pumps. Controls have motor starter software.
- Can't use # 167085 impeller kit.



## **# 437345 pump for water switches**

- More powerful for use with water switches (Apexx & ExactWash models).
- Has separate motor starter (# 182318).
- Must use with heaters with water switches & sumps with extra filter cylinder.
- Can use # 167085 impeller kit.

**NOTE:** Cheater cords can't be used to check Sicasym and BLDC pumps since they use special starters.



# Part # 3 -- Control Modules

## ***Disassembly***

*(SHU 9922 shown)*

Control modules are easily removed from fascia panels by bending console tabs.

*Tools needed: T-20 Torx & flat blade screwdrivers.*

1. Remove fascia panel by removing T-20 Torx inner door screws.
2. Disconnect wire harnesses from module after noting connector locations.
3. Pry out metal console tabs holding module to console.
4. Carefully pry back plastic tabs, then slide module from console.

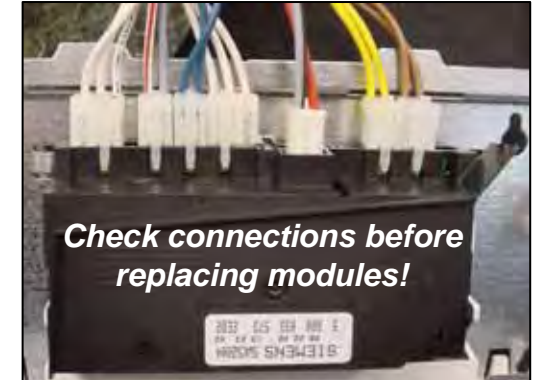

**Check connections before replacing modules!**



**Removing door screws**



**Removing fascia panel**



**Viewing control module**



**Disconnecting wires**



**Bending back tabs**



**Sliding module out**

**TIP:** Modules have been replaced when problem was loose connections. Before replacing modules, check connections first!

**NOTE:** Control modules for non-integrated models look differently and have different tabs, but are removed using the same procedure.

# Part # 3 – Apexx Control Modules

## Disassembly



These instructions apply to SHE/SHV/SHX98-99 models.

**HINT:** Apexx control modules cannot be checked or have resistances measured from the front of dishwashers.

**NOTE:** Modules were moved to the base to make room for the larger full text displays in the fascia panel.

Apexx (SHV99A/SHX99A-B/SHY99A, DWHD94) control modules are different than other models and are removed differently. Modules are mounted on the base (where base wiring connectors were), not behind fascia panels. This means:

- **Dishwashers must be pulled out to change control modules.**
- **Dishwashers must be pulled out to measure voltages & resistances.**

### For access to Apexx control modules:

Tools needed: T-20 Torx screwdriver & pliers.

1. **Remove outer door** – see page 3.
2. **Remove toe kick** – see page 4.
3. **Remove right/left side panels** – see page 4.
4. **Raise right side of tank** – see page 5.

**HINT:** Its helpful, but not necessary, to remove outer doors to access Apexx control modules.

**HINT:** It may be possible to reach behind modules without blocking up tanks. If not, then follow these instructions to block up tanks.

# Service Tips – Fault Codes & Control Coding

Controls contain codes for factory tests, customer service test program, dishwasher configuration and fault codes. Consult test programs and fault codes for each dishwasher before using codes below.

## **P(X) Program codes**

P0 = Functional test - used for assembly

P1 = Customer service test program

P3 = Endurance/Life test

P4 = Control coding (see “C(X)” control codes below)

## **E(X) Error codes**

E0 = No errors

E1 = Heating error

E2 = NTC error

E3 = Filling error

E4 = Water switch cannot be positioned

E5 = Safety level reached

E6 = Aqua sensor error

## **C(X) Control Codes**

Codes C1 to C9 possible, depending on dw model



***HINT:*** Customers pushing *Cancel-Drain* or *Cancel-Reset* buttons while dw's are off can see codes, leading to service calls.

# Service Tips -- Modules Displaying "1"

Occasionally dishwashers can run for hours, not finish washing & show a "1" in the display. This means the module has timed out due to an unidentified heating problem -- all heating related parts must be checked until the problem is found.

*TIP: Modules have been replaced when problem was loose connections. Before replacing modules, check connections first!*

**IMPORTANT:**  
Whenever a "1" shows in the module display, the module must be reset (after the heating problem has been fixed) by running the dishwasher. The module resets after the 1<sup>st</sup> run.

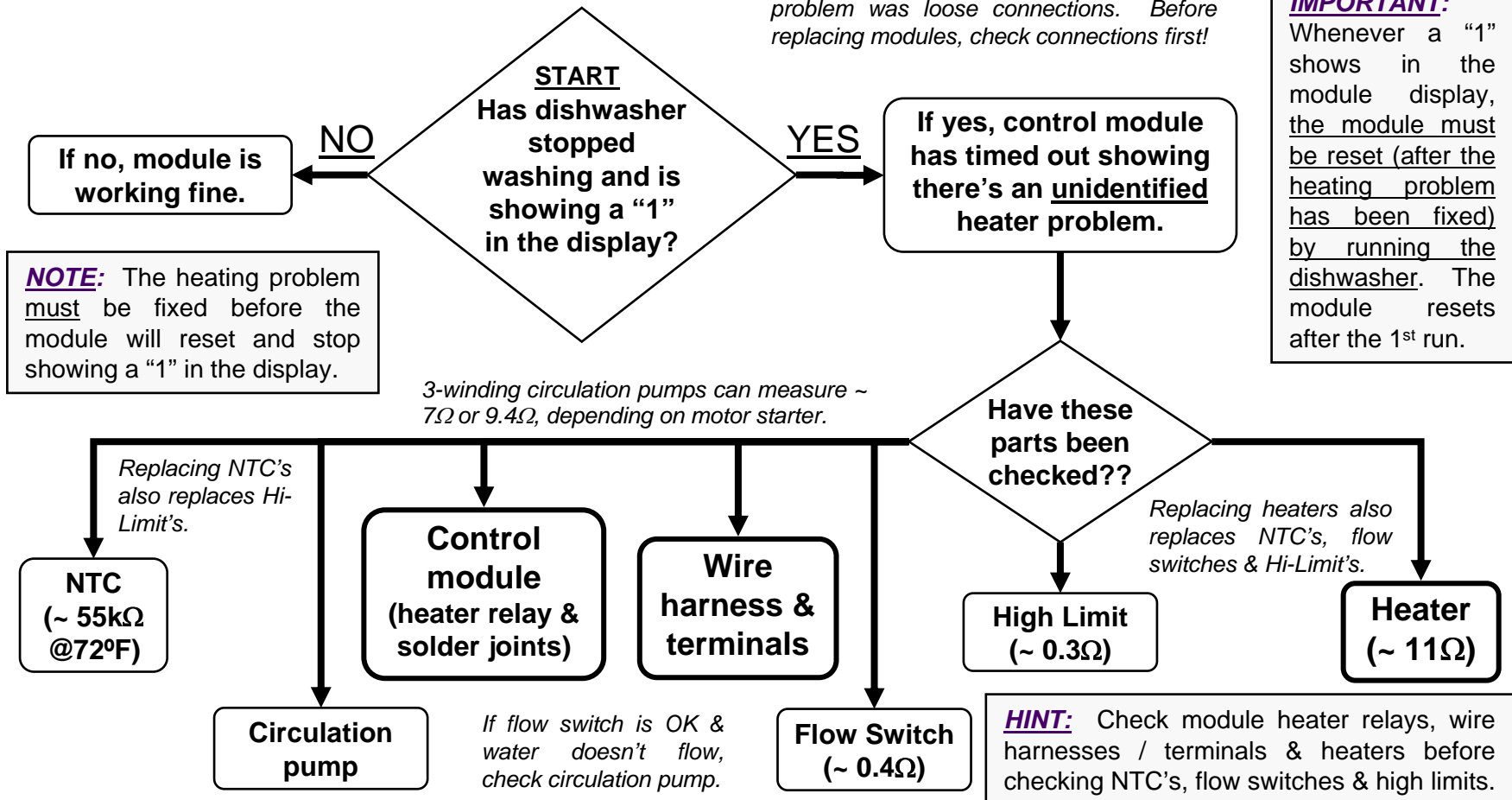

## Part # 4 -- Heater & NTC (1)

### Disassembly

The heater & NTC can be accessed or measured from the right side of the dishwasher, but can only be removed by dropping the entire base (by flipping the dishwasher on its back) since they are wedged underneath the tank.

#### For access to heaters & NTC's:

Tools needed: T-20 Torx screwdriver & pliers.

1. **Remove outer door** – see page 3.
2. **Remove toe kick** – see page 4.
3. **Remove right/left side panels** – see page 4.
4. **Raise right side of tank** – see page 5.

**HINT:** The fascia panel and door don't need to be removed to access the heater & NTC. However, the door must be removed to completely remove the tank.

**HINT:** Remove all water from the sump and hoses before accessing the heater -- when the dishwasher is flipped on its back, water can enter the water fill assembly diaphragm and cause the dishwasher to not fill properly.

#### To separate base from tank (1):

1. Carefully lay dishwasher on its back.
2. Carefully pull door springs out from base.



**Placing on back**



**Pulling out door springs from base & disconnecting cords**



## Part # 4 -- Heater & NTC (2)

### To separate base from tank (2):

3. Remove terminal blocks from base (for two-piece harnesses).
4. Disconnect hose from water valve (or remove water valve from base if easier).
5. Disconnect J-box ground wire, then pull wires out of J-box.
6. Pull out inlet hose from sump.
7. Carefully pull base away from tank and sump.

**HINT:** Remove water from sump and hoses before laying dishwasher on its back (to avoid water entering water fill assembly & causing faulty water filling).



**Removing terminal blocks from base**

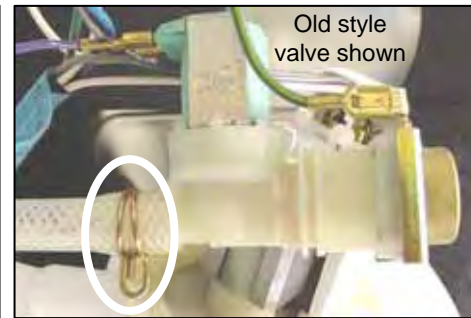

**Disconnecting hose from water valve**



**Pulling J-box wires**



**Pulling out sump hose**



**Pulling base carefully from tank & sump**



## Part # 4 -- Heater & NTC (3)

### To remove heater & NTC:

1. Remove two (2) T-20 Torx screws holding heater assembly to sump.
2. Disconnect wires from heater, flow switch, NTC & Hi-Limit after noting connections.
3. Pull clips, then carefully pull heater assembly from sump & pump. Note heater comes as an assembly (with housing & gasket).

**NOTE:** Softer bearing & non-softer bearing heater assemblies, circulation pumps and sumps **cannot** be mixed and matched. Softer bearing heaters don't fit in older models and older heaters don't fit in softer bearing models.



**HINT:** If needed, use rinse-aid to lubricate gaskets to make it easier to assemble heater to sump and pump.

### **Heater assembly    Removing heater screws    Removing heater from sump/pump**

**NOTE:** Softer bearing & non-softer bearing heater assemblies are connected to circulation pumps differently:

- Softer bearing models (UC/11 & above) have gasket assembled to heater and have a separate hose clamp (order # **172272**).
- Older models (UC/06) have a separate gasket and do not have a hose clamp.

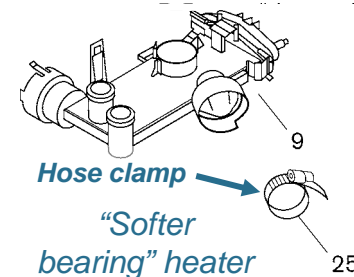

**HINT:** Heater assemblies contain NTC's, Hi-Limit's & flow switches (& aqua sensors where applicable). If heaters are replaced, these parts are replaced too.

# Service Tips -- Heater Troubleshooting Flowchart

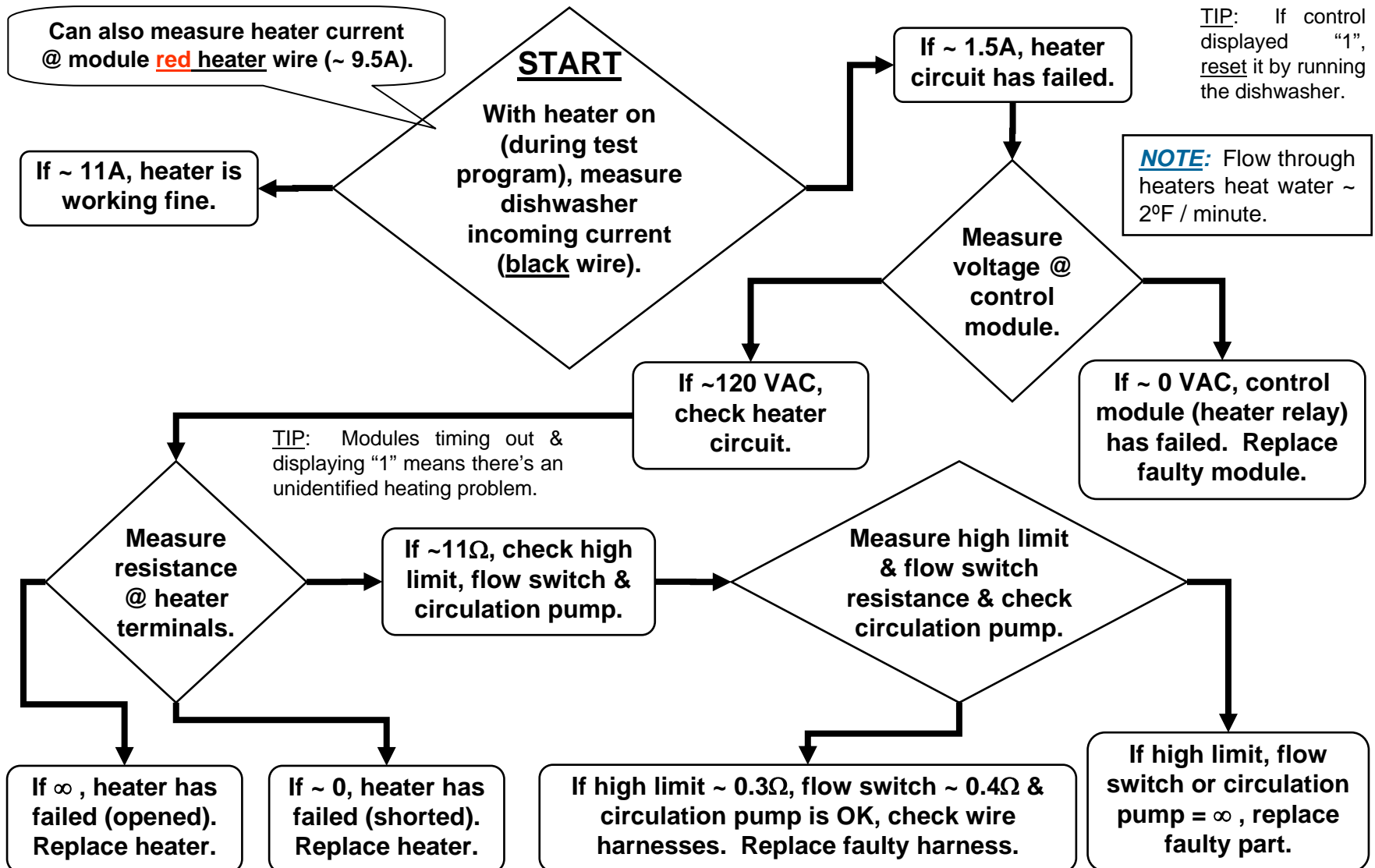



# Service Tips – Heater Operation

Flow through heater heats water without an exposed tank element. Filtered water enters the heater from the circulation pump. The heater heats water when the flow switch signals water is present.

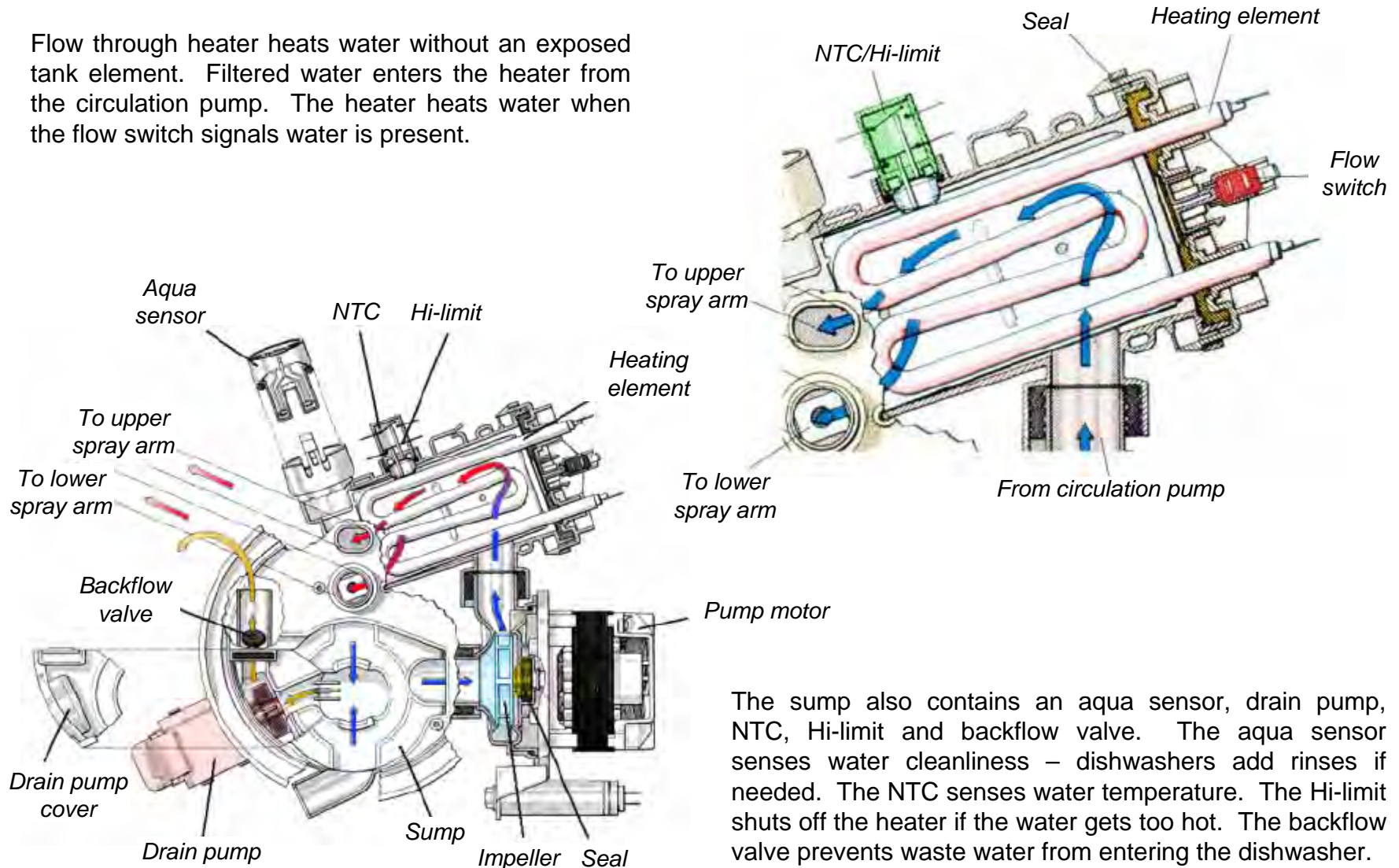

The sump also contains an aqua sensor, drain pump, NTC, Hi-limit and backflow valve. The aqua sensor senses water cleanliness – dishwashers add rinses if needed. The NTC senses water temperature. The Hi-limit shuts off the heater if the water gets too hot. The backflow valve prevents waste water from entering the dishwasher.

# Service Tips -- Water Switch (“Flow Control”)

Motor operated water switches are mounted underneath heater assemblies. They consist of a motor-controlled disk (with 3 holes) which rotates and lines up over two sump ports (upper / lower spray arms) to provide precise water control to upper, lower or both spray arms.

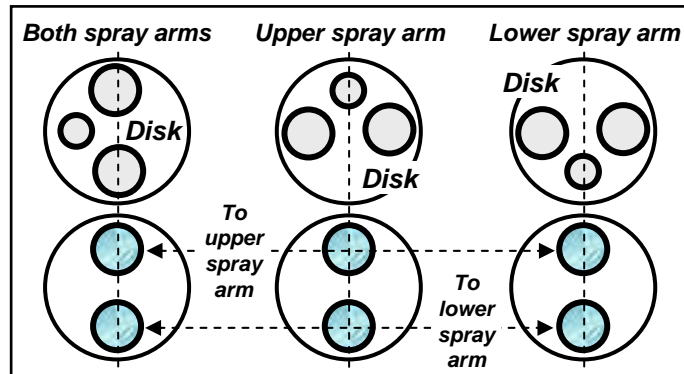
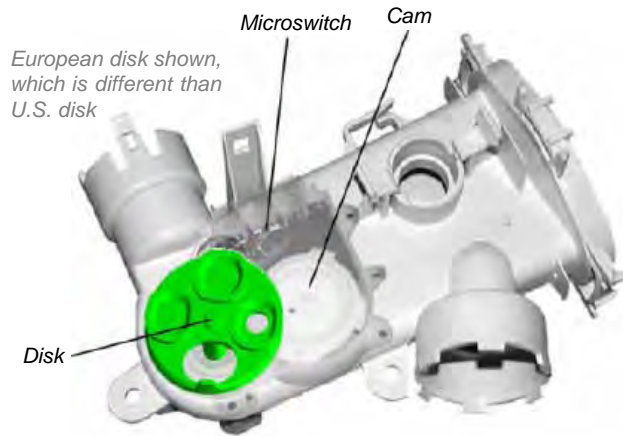

**HINT:** Models with water switches & Top Rack Only use water switches to divert water. Separate actuators aren't needed.

**HINT:** Models with water switches need stronger circulation pumps (# 437345) with separate motor starters (# 182318). Circulation pumps, heaters & sumps for water switch / non-water switch models **can't** be interchanged.

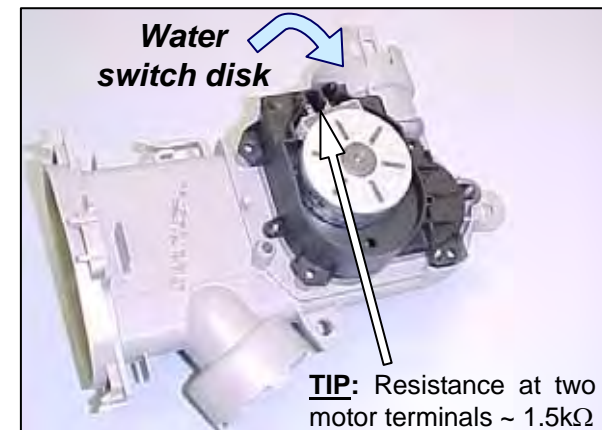
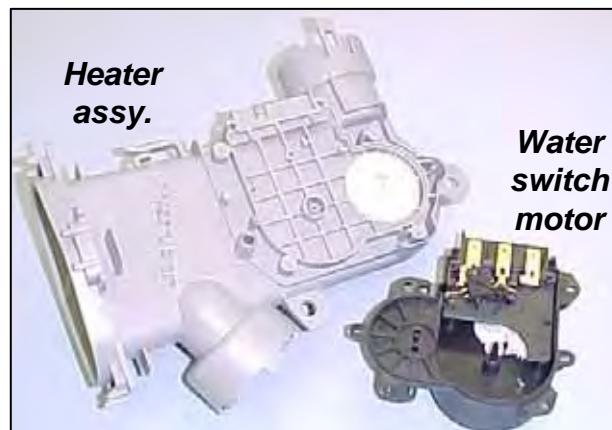
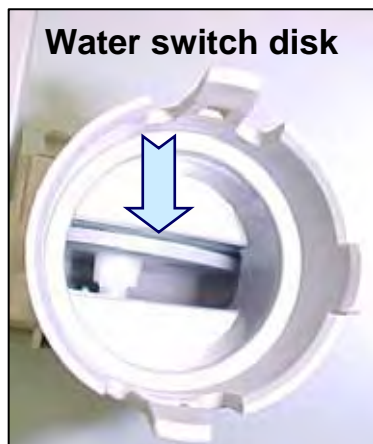

# Part # 5 -- Drain Pumps

Drain pumps are mounted to sumps in the front of dishwashers -- they're easily accessible from the front of dishwashers by removing toe kicks.

## **To remove & install drain pump:**

*Tools needed: small flat blade screwdriver (for unlocking terminals).*

- Remove toe kick/base cover, pull up terminal cover and disconnect wires (using screwdriver to unlock locking terminals).
- To remove pump, pull latch (on circular collar) & rotate pump clockwise (cw). To install new pump, insert @ 2:00 position & rotate counterclockwise (ccw).
- Clean water & debris from base, then check float operation.
- Connect wires, then install base cover & toe kick.

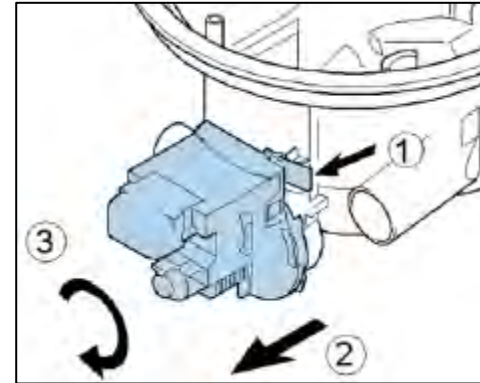

**NOTE:** Drain pump is rated 120V, 60 Hz, 35W, 0.85A.

## **DRAIN HOSE INSTALLATION TIPS:**

- Must have drain hoses with high loops (min. 20" high), even with air gaps \*.
- Drain hoses can be up to 10' long – can add up to 4' to dishwasher hose.
- Secure drain hoses to rear of dishwashers with non-metal bands.
- Make sure drain hoses aren't kinked.
- UC/43 & later drain pumps have (Rast 5) connectors, which aren't interchangeable with older pumps with spade terminals (listed below).

**NOTE:** Drain pumps in installations with Johnson Tees (in Washington State) must use stronger 4-vane pumps (# **184178**). Standard 9-vane drain pumps (# **167082**) are quieter and smoother than 4-vane pumps. Older pumps had 6-vanes.



\* **NOTE:** High loops are needed to prevent cavitating.

**TIP:** Often improper installations, not drain pump issues, cause dishwashers to not drain properly.

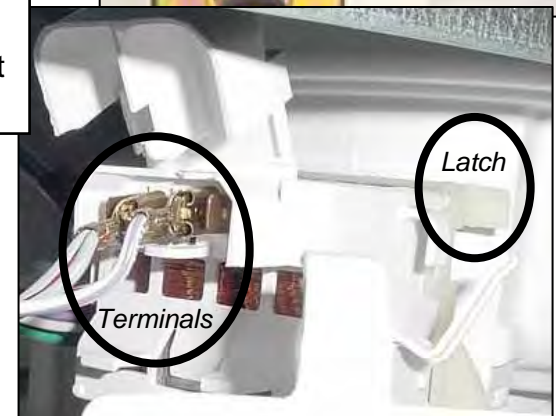
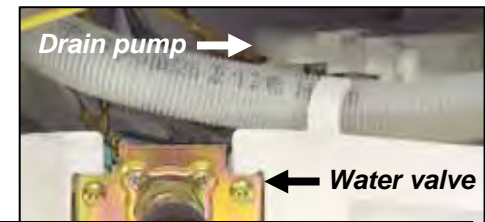

# Part # 6 -- Dispensers (1)

## Disassembly

**CAUTION:** Inner door edges are sharp! Cover door edges and remove dispenser carefully.



*Disconnecting wire harness*



*Bending retainer tabs*



### HINT: To remove/install dispensers:

- Remove outer door, remove fascia panel & disconnect wire harness from fascia panel.
- Disconnect wire harness above dispenser, then remove wires to wax motor & sensor.
- Disconnect condensation tube (for older models with condensation tubes in doors).
- Remove any tape or wire ties. Bring replacement wire ties for reassembly.
- Bend retainer tabs, then push dispenser inward toward tank. Protect hand with towel as inner door edges are sharp.
- Replace from inside of tank -- position O-ring seal and bend tabs to secure. Lubricate O-rings with rinse-aid & support inner doors to avoid damage if O-rings stick.

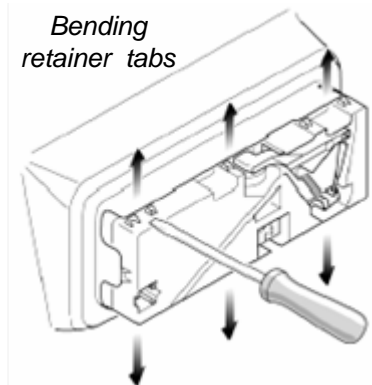

## Part # 6 -- Dispensers (2)

During each wash program, the wax motor opens twice, once to dispense detergent and again to dispense rinse-aid. The wax motor opens the same -- linkages open the detergent door & operate the rinse-aid dosage plunger. Dispensers can have reed switches or optical rinse-aid sensors.

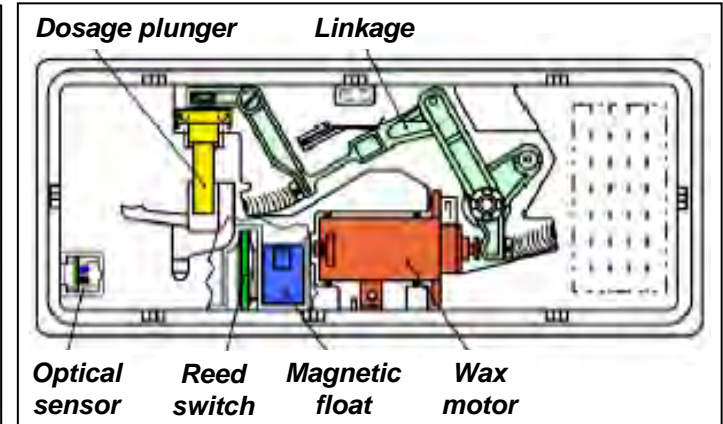

**NOTE:** The white plastic linkage opens the detergent dispenser door, then cocks in place to dispense rinse-aid when the wax motor operates again. After the 2nd operation, the linkage resets for the next wash.

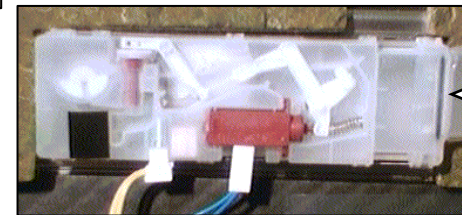

Condensation tube (older vented dispenser)

**HINT:** Optical dispensers have different connections and can't be substituted for reed switch dispensers. Note **431413** top load dispensers also use solenoid actuators instead of wax motors.

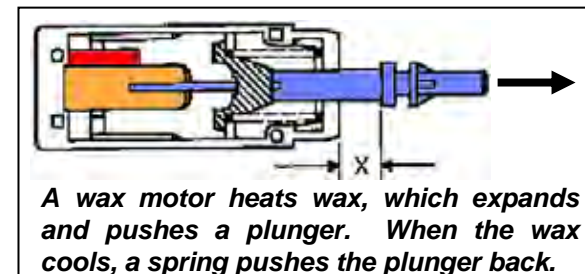
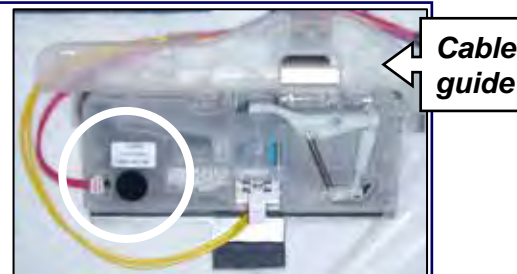

# Service Tips – Optical Sensor Dispensers

Optical and top-load dispensers measure rinse-aid levels with optical sensors instead of reed switches.

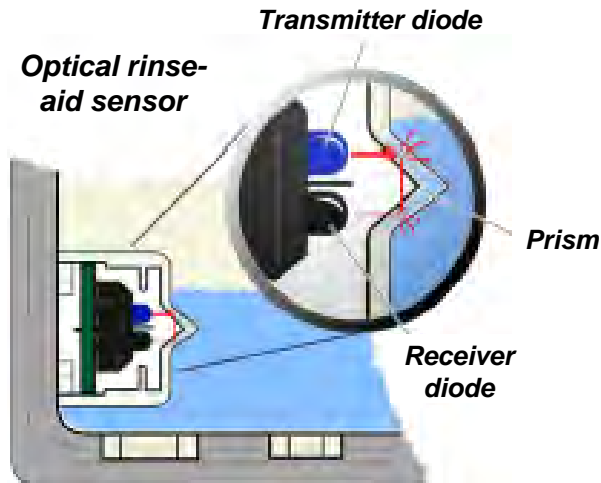

*With rinse-aid present, the optical receiver senses a diffused light beam.*

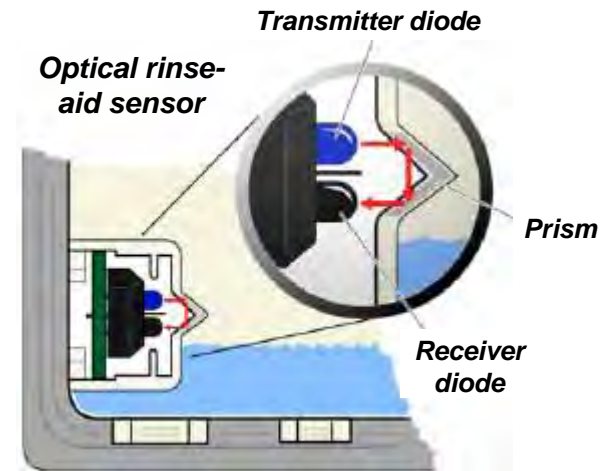

*When rinse-aid has run out, the optical receiver senses a strong light beam.*

**HINT:** Optical dispensers have different connections and can't be substituted for reed switch dispensers.

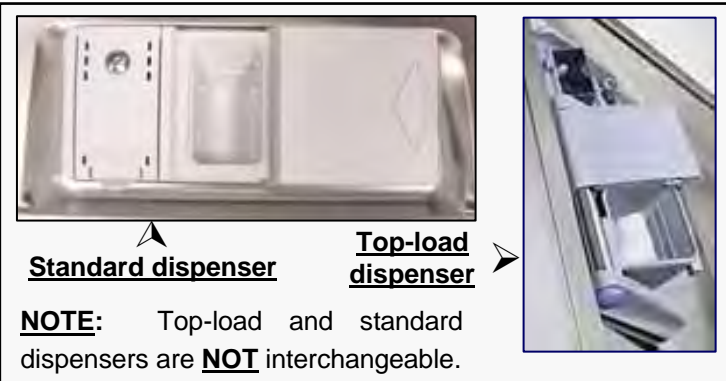
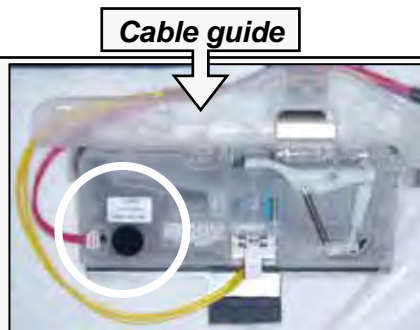

# Part # 7 -- Door Latches

## Disassembly/ Installation

Other than occasional misalignment, the only door latch repairs will be replacing microswitches. Older SHU43/53/68 dishwashers used door latches with rods connecting them with on/off switches.

### To disassemble door latches:

1. Remove T-20 Torx fascia panel screws from inner door.
2. Lower fascia panel from door.
3. Locate door latch in console.
4. Bend out console metal tabs to allow latch removal.

**NOTE:** Use only latches specified for each model. Latches can have differing closing forces, be suitable for specific door seals & can have child locks.

**NOTE:** Door latches for UC/14 & up models are different than UC/06 - UC/12 models -- they cannot be interchanged. Must replace strike plate & door latch together.



**Remove panel screws**

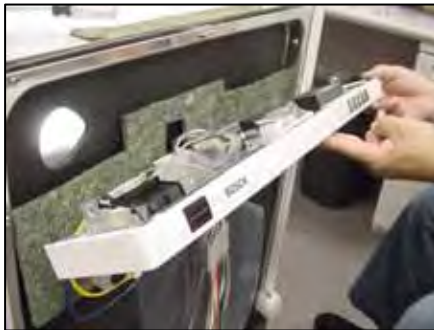

**Lower fascia panel**

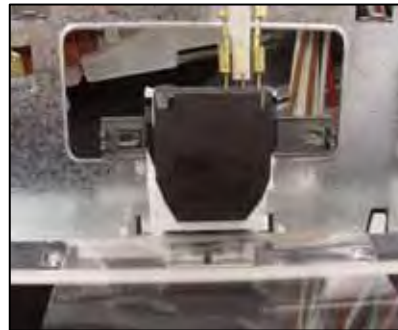

**Door latch in console**



**Tabs (inner view)**



**Bend out metal tabs**

## Part # 8 -- Aqua Sensors

The aqua sensor only affects energy usage, eliminating a pre-wash and/or pre-rinse cycle if water is clean. Most customers won't notice if an aqua sensor fails. It's located on the rear of the sump and can be reached through the left side of the dishwasher (after the left side panel is removed – see page 4). Its not necessary to block up the tank to reach the aqua sensor.

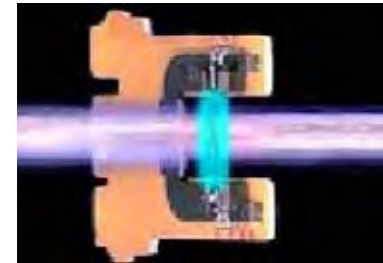
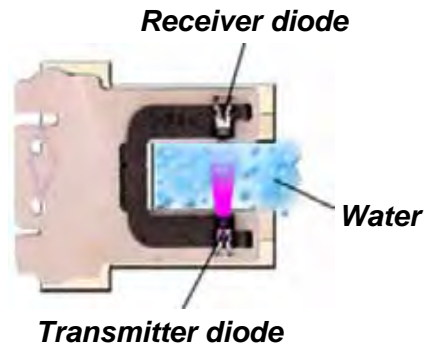
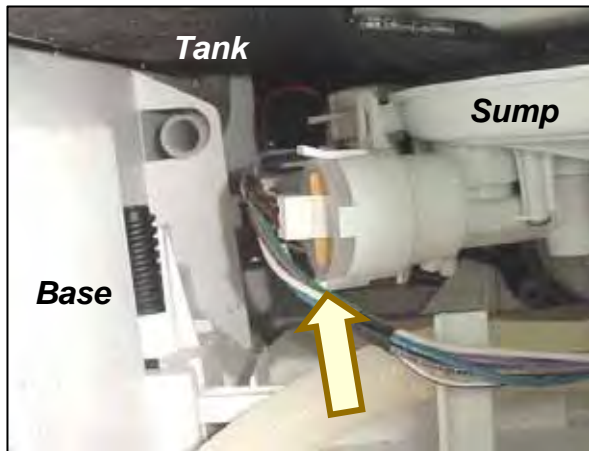

**NOTE:** Aqua sensors provide ~ 20% energy savings.

**HINT:** To change out the aqua sensor, pull off the connector and pull out the aqua sensor (toward the rear of the dishwasher). The aqua sensor slides into slots in the sump. Make sure the aqua sensor is properly inserted into the slots.

**NOTE:** The *Apexx Sensotronic 2* aqua sensor # **175340** is similar to standard aqua sensor # **165279**, except it has two (red & green) soil sensors. They mount the same way, but are **not** interchangeable.

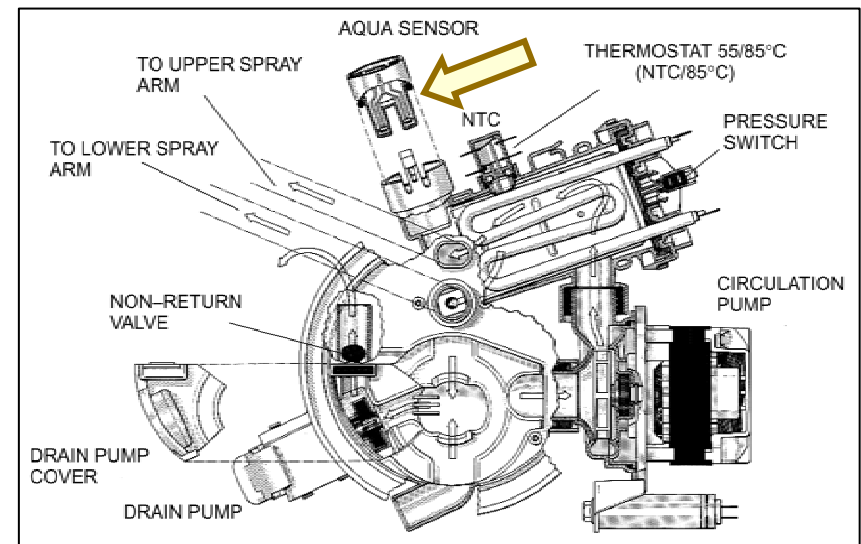



## Part # 9 -- Water Fill Assembly

The water fill assembly is easily accessed from the left side by just removing the left side panel (see page 4). It can be a pressure-fill (with diaphragm) or time-fill, depending on model.

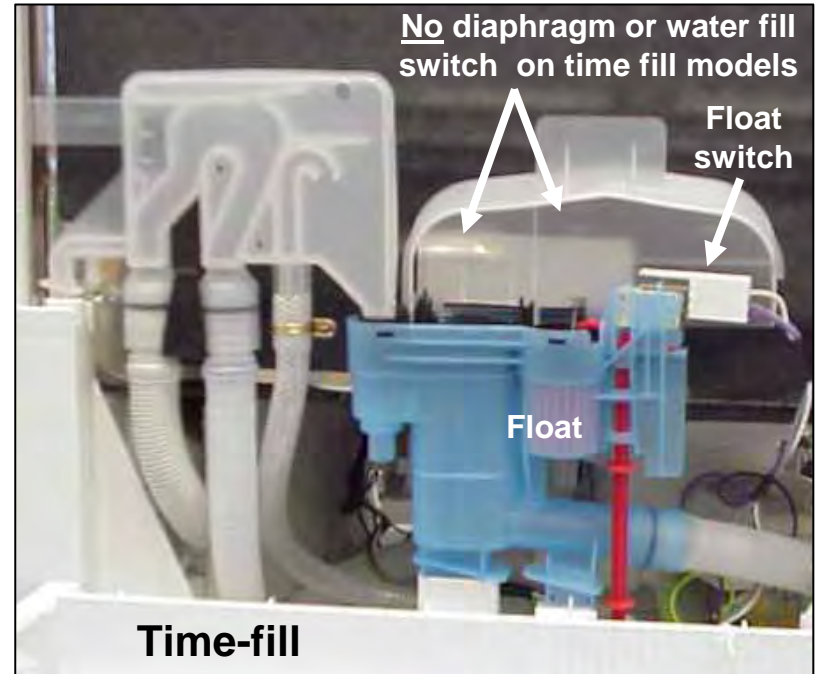
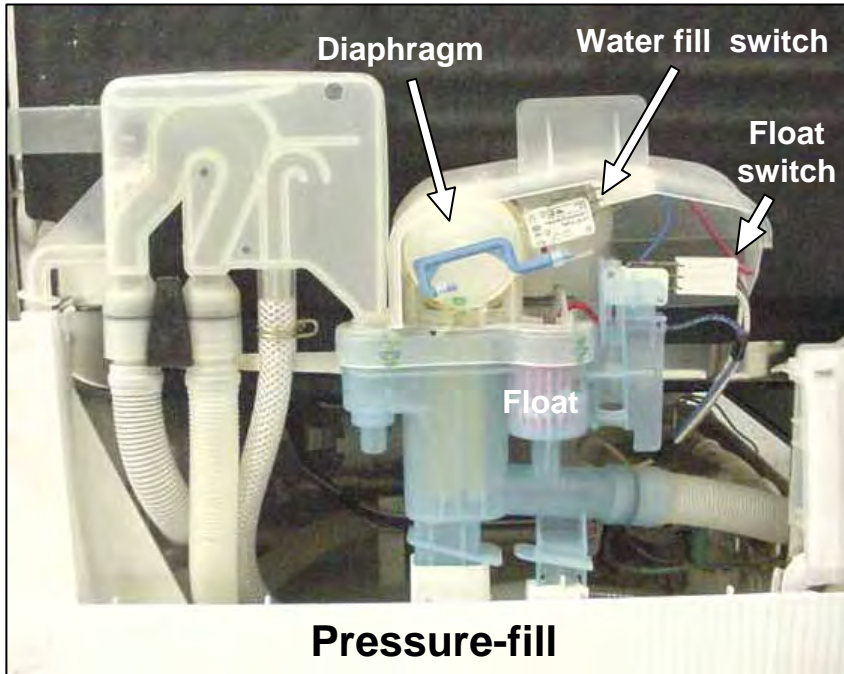

**HINT:** Most water fill assembly repairs involve replacing microswitches. Occasionally tank insulation or other debris can prevent the diaphragm switch lever from operating, allowing overfilling.

**NOTE:** Water inlet valves for time and pressure-fill look the same, but pressure-fill valves can't be used on time-fill models. Presently, both pressure-fill and time-fill models use time-fill valve **425458**.

**TIP:** Floats should be checked and bases should be cleared of water & debris whenever water fill assemblies are worked on.

# Miscellaneous Service Tips – Hinge Levers & Bushings

Since 12/15/03, all dishwashers have upgraded hinge levers and hinge bushings. New hinge levers and bushings can't be used with old bushings and levers – must replace levers and bushings together.

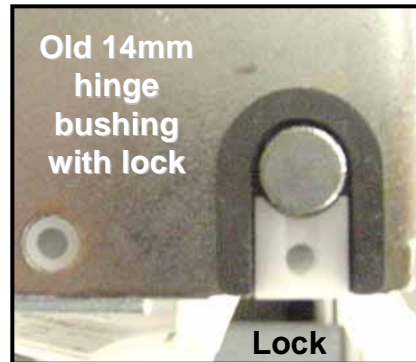

**NOTE:** New and old hinge levers and bushings can't be mixed and matched since new hinge levers have 15mm holes to fit new hinge bushings and old hinge levers had 14mm holes for old hinge bushings (and locks).

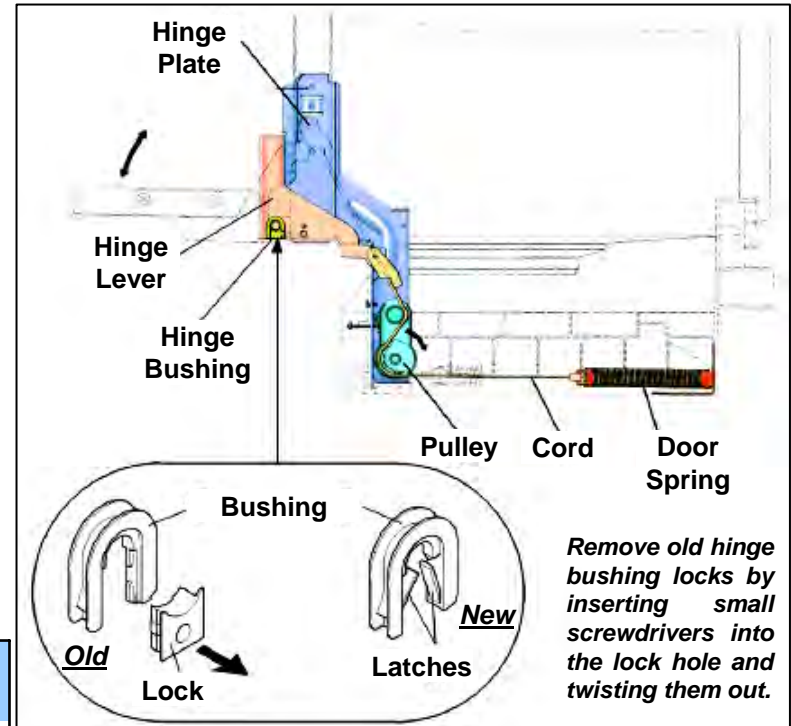

Replacement Hinge Levers and Bushings				
Side	Part #	Description	Replaced by	Description
Left	<b>492033</b>	Lever (14mm)	<b>494876 + 165296</b>	Lever + bushing (15mm)
Left	<b>488250</b>	Bushing (14mm)	<b>494876 + 165296</b>	Lever + bushing (15mm)
Left	<b>263115</b>	Lever + bushing (14mm)	<b>494876 + 165296</b>	Lever + bushing (15mm)
Right	<b>492034</b>	Lever (14mm)	<b>494875 + 165296</b>	Lever + bushing (15mm)
Right	<b>488250</b>	Bushing (14mm)	<b>494875 + 165296</b>	Lever + bushing (15mm)
Right	<b>263119</b>	Lever + bushing (14mm)	<b>494875 + 165296</b>	Lever + bushing (15mm)

**TIP:** Unlike old hinge bushings, new hinge bushings are self-locking and don't need separate locks. To remove doors when new hinge bushings are used, spread latches apart until door pins clear latches.

**NOTE:** When new 15mm hinge bushings (with latches) are opened, replace them instead of reusing them.

## Miscellaneous Service Tips – FAQ's (2)

- Wood door spring usage chart – Once original door spring has been identified (**Orange 182640** or **Violet 168568**), use chart below to adjust spring tensions:

	Door Wood Panel Weight				
Existing Door Spring	Less than 5.5 lbs (2.5 kg)	5.5 to 9 lbs (2.5 to 4.1 kg)	9 to 15 lbs (4.1 to 6.8 kg)	15 to 18 lbs (6.8 to 8.2 kg)	18 to 21 lbs (8.2 to 9.5 kg)
<b>Violet (168568)</b>	Change to <b>173696 Yellow</b> spring - use tension screw if needed	Change to <b>168576 Blue</b> spring - use tension screw if needed	No action	Use tension screw to increase tension	Change to <b>182640 Orange</b> spring - use tension screw if needed
<b>Orange (182640)</b>	Change to <b>168576 Blue</b> spring - use tension screw if needed	Change to <b>168568 Violet</b> spring	No action	Use tension screw if needed to increase tension	Use tension screw to increase tension

# ?? Dishwasher Service Pop Quiz ??

1. A high loop in the drain hose must be used in installations with air gaps (T/F).
2. A cheater cord can be used to check all circulation pumps (T/F).
3. All dishwashers have a control module mounted in the top of the door (T/F).
4. A dishwasher showing a “P” or “C” code after installation is faulty from the factory and must be exchanged (T/F).
5. One water valve can be kept on your truck for all replacements (T/F).
6. Any time a dishwasher runs for several hours or times out, the problem will be solved if the control module is replaced (T/F).
7. Match each circulation pump with it's starter:
  - a) Pump # 239144
  - b) Pump w/ water switch # 437345
  - c) Sicasym pump # 442548
  - d) BLDC pump # 665510
  - a) PTC motor starter
  - b) 3-phase motor starter
  - c) Software in main control
  - d) Start capacitor w/ cutout switch
8. If a door latch is on backorder, another type can be used (T/F).
9. Aqua sensors don't have to be replaced if they fail (T/F).
10. Drain pumps have changed little over the years and are interchangeable with all dishwasher models (T/F).

# ?? Dishwasher Service Pop Quiz ?? Answers

1. A high loop in the drain hose must be used in installations with air gaps (T/F). **T**
2. A cheater cord can be used to check all circulation pumps (T/F). **Not Sicasym, BLDC** **F**
3. All dishwashers have a control module mounted in the top of the door (T/F). **F**
4. A dishwasher showing a “P” or “C” code after installation is faulty from the factory and must be exchanged (T/F). **Exit control coding mode** **F**
5. One water valve can be kept on your truck for all replacements (T/F). **F**
6. Any time a dishwasher runs for several hours or times out, the problem will be solved if the control module is replaced (T/F). **Check heater system** **F**
7. Match each circulation pump with it's starter:
 

a) Pump # 239144	←	a) PTC motor starter
b) Pump w/ water switch # 437345	←	b) 3-phase motor starter
c) Sicasym pump # 442548	←	c) Software in main control
d) BLDC pump # 665510	←	d) Start capacitor w/ cutout switch
8. If a door latch is on backorder, another type can be used (T/F). **F**
9. Aqua sensors don't have to be replaced if they fail (T/F). **T**
10. Drain pumps have changed little over the years and are interchangeable with all dishwasher models (T/F). **Rast 5 connector starting UC/43** **F**