

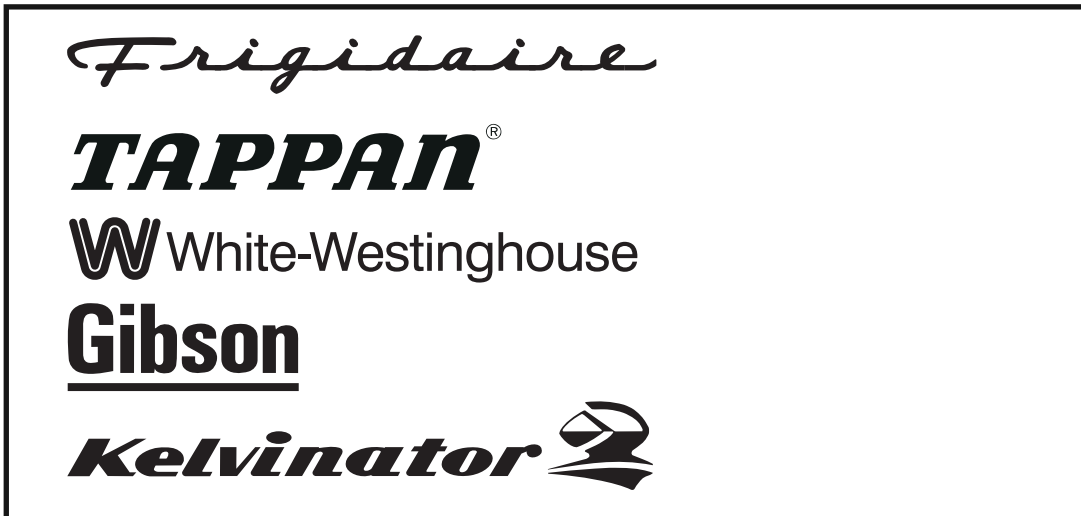

ELECTROLUX HOME PRODUCTS NORTH AMERICA

**SERVICE UPDATE MANUAL
FOR 30" GAS
FREESTANDING RANGES**



! ATTENTION !

This service manual is intended for use by persons having electrical and mechanical training and a level of knowledge of these subjects generally considered acceptable in the appliance repair trade. Electrolux Home Products cannot be responsible, nor assume any liability, for injury or damage of any kind arising from the use of this manual.

Table Of Contents

SAFE SERVICING PRACTICES.....	3	REMOVING DOOR LATCH HOOK ASSEMBLY . . .	23
SERVICE TIPS		REPLACING OVEN DOOR LIGHT SWITCH	24
DEVELOP GOOD WORK HABITS.....	4	SERVICING OVEN BURNERS AND	
SERVICE TOOLS AND EQUIPMENT	5	COMPONENTS	24-26
CHANGES AND FEATURES OVERVIEW	5	Convection Fan Blade Cover	24
ABBREVIATIONS AND TERMS.....	5	Removing Oven Bottom	24
MODEL NUMBERING SYSTEM	6	Servicing Bake Burner and Ignitor	25
SERIAL NUMBERING SYSTEM.....	6	Servicing Broil Burner and Ignitor	26
RANGE TECHNICAL DATA.....	7-9	DIAGNOSING OVEN COMPONENT	
Quick Reference Sheet.....	7	FAILURE.	27-29
Maximum Allowable Surface Temperatures.....	7	Incorrect Voltage	27
RTD Temperature / Resistance Chart.....	7	Gas Regulator Cut Off Lever	27
Removing and Replacing Warmer Drawer	7	Faulty Oven Ignitor	27
Gas Range Component Resistance Chart.....	8	Faulty Gas Safety Valve	27
Oven Temperature Calibration	8	How The Safety Valve Works.....	28
EOC Failure / Fault Codes.....	9	Safety Valve LP Gas Conversion	29
RANGE INSTALLATION INSTRUCTIONS	10-18	WARMER DRAWER	30-32
Delivery Installation Bulletin.....	10	Warmer Drawer Theory of Operation.....	30
Clearances and Dimensions	11	Troubleshooting Warmer Drawer Operation	31
Important Safety Information	12	Servicing Warmer Drawer Components.....	31-32
Tools You Will Need	13	OVEN DOOR.....	33-35
Anti-Tip Bracket Installation Instructions . . .	13-14	Remove and Replace Oven Door	33
Gas Supply Connection	14-15	Door Hinge Replacement.....	34
Electric Requirements	15	Replacing Door Hinge Receptacle.....	35
Extension Cord Precautions.	15	BODYSIDE MOUNTING	36
Burner Head Assembly	16	LEG LEVELERS.....	36
Electric Ignition Surface Burners	16	COMPONENT TESTING.....	37-38
Adjusting Burner Flame (Low Setting)	17	ELECTRONIC OVEN CONTROLS	39-40
Operation of Oven Burners & Adjustment . .	17-18	ES 200 CONTROL.....	39
Model & Serial Number Location	18	ES 300 CONTROL.....	39
Care, Cleaning & Maintenance	18	ES 330 CONTROL.....	39
Before You Call For Service	18	ES 340 CONTROL.....	40
GAS RANGE COOKTOP STYLES	19-20	ES 510 CONTROL.....	40
COOKTOP SERVICING	21-22	TROUBLESHOOTING ELECTRONIC OVEN	
Removing And Replacing Cooktop.	21	CONTROLS.....	41-42
Manifold Panel and Burner Box	22	EOC Failure / Fault Codes.....	42
Replacing Orifice Holders	23		
Surface Burner Valves	23		

SAFE SERVICING PRACTICES - ALL APPLIANCES -

To avoid personal injury and/or property damage, it is important that Safe Servicing Practices be observed. The following are some limited examples of safe practices:

1. **DO NOT** attempt a product repair if you have any doubts as to your ability to complete it in a safe and satisfactory manner.

2. Before servicing or moving an appliance:
 - Remove the power cord from the electrical outlet, trip the circuit breaker to the OFF position, or remove the fuse.
 - Turn off the gas supply.
 - Turn off the water supply.

3. Never interfere with the proper operation of any safety device.

4. **USE ONLY REPLACEMENT PARTS CATALOGED FOR THIS APPLIANCE. SUBSTITUTIONS MAY DEFEAT COMPLIANCE WITH SAFETY STANDARDS SET FOR HOME APPLIANCES.**

5. **GROUNDING:** The standard color coding for safety ground wires is GREEN, or GREEN with YELLOW STRIPES. Ground leads are not to be used as current carrying conductors. It is EXTREMELY important that the service technician reestablish all safety grounds prior to completion of service. Failure to do so will create a hazard.

6. Prior to returning the product to service, ensure that:
 - All electrical connections are correct and secure
 - All electrical leads are properly dressed and secured away from sharp edges, high-temperature components, and moving parts
 - All non-insulated electrical terminals, connectors, heaters, etc. are adequately spaced away from all metal parts and panels
 - All safety grounds (both internal and external) are correctly and securely connected
 - All panels are properly and securely reassembled

ATTENTION!!!

This service manual is intended for use by persons having electrical and mechanical training and a level of knowledge of these subjects generally considered acceptable in the appliance repair trade. Electrolux Home Products cannot be responsible, nor assume any liability, for injury or damage of any kind arising from the use of this manual.

SERVICE TIPS - DEVELOP GOOD WORK HABITS

Consistently following a standard procedure when servicing appliances will insure that you do not waste time searching for a complex solution to a simple problem. **One of the most common mistakes made by service technicians is failing to verify the incoming power supply to the appliance.**

Many times electronic oven controls and other components are replaced unnecessarily because the incoming power supply was not verified. The technician assumes that the power supply must be good because the top burners or surface elements work. Most electronic controls must have a 120 volt power supply before they will operate. This is usually accomplished by supplying L1 voltage and **neutral or ground** from the household power supply. On most electric ranges if the neutral or ground circuit fails the top surface elements will still operate but the electronic control as well as any other 120 volt components such as the oven lamp, self clean latch motor, and some indicator lamps will not function.

When testing the electrical supply to an electric range the test should be performed at the terminal block where the power cord or house wiring attaches to the range. Verify that there are 240 volts to the two outside terminals on the block and that there is 120 volts from each of the outside terminals to the neutral terminal in the center of the terminal block. You should also check the power supply while the range is operating or “under load”. The power supply may check good with the range sitting idle but fail when the elements are turned on. This can be caused by a weak connection in the customer’s house wiring, or a faulty circuit breaker or fuse.

When servicing a gas range the power supply should be checked at the wall outlet with a plug in circuit tester or volt meter. Make sure that the outlet is properly polarized and grounded. There are many good plug-in circuit/polarity testers available that will perform this test quickly and easily. When testing with a volt meter remember that the narrow slot in the wall outlet is the L1 or voltage side of the circuit and the wide slot is the neutral. The round or “D” shaped hole is the ground circuit. A properly polarized 120 volt wall outlet will have voltage between the L1 (narrow slot) and neutral (wide slot) as well as between L1 and ground (See Fig. 1 below). Do not assume that because the wall outlet has a ground slot that it is grounded. **Check it out!** Modern electronic controls must have a correctly polarized and grounded power supply for proper operation.

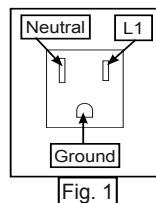

Another common mistake is failure to verify all component part wire harness connections. It is essential that all component connections be checked visually and with the appropriate circuit tester. Many times components are assumed to be faulty because they do not operate when the failure is caused by a loose or miswired connection. New ranges may have loose connections resulting from shipping and handling conditions or improper installation. A good example is if the EOC on a new range can not be programmed it could be due to a faulty temperature sensor probe connection. Most Electronic Oven Controls will not allow programming if there is no input from the probe. Check it out before you replace the EOC.

When the repair has been completed the product should be thoroughly tested to verify that the service performed corrected the problem and that all of the other features and functions of the product are in proper working order. The extra time taken to do this will create consumer confidence in your efficiency and professionalism as well as possibly saving an expensive callback.

SERVICE TOOLS AND EQUIPMENT

In addition to standard hand tools such as wrenches, screwdrivers, pliers, etc; the following instruments are considered to be essential equipment for technicians servicing Electrolux cooking products. Proper testing and diagnostic procedures are not possible without these tools.

- Volt/ohmmeter - Must be capable of voltage measurement from 0 to 500 volts AC and resistance measurements from 0 to 2 meg-ohms. This usually requires a meter that utilizes a 9 volt battery. Either digital or analog meters are acceptable however most technicians find analog meters easier to use.
- Clamp on amp meter - Should be capable of measuring from 0 to 60 amps.
- Temperature Meter - Should be high quality with thermocouple or electronic "K-type" test probe. Capable of temperature readings up to 1000 degrees Fahrenheit.

Additional instruments that a technician will need to have access to at various times include the following:

- Combustible gas leak detection meter.
- U tube manometer or equivalent testing device for measuring LP and Natural gas line pressure on gas ranges. Measurements must be in IWC (inches water column)
- Carbon Monoxide (CO) detection meter capable of measuring from 0-1000 PPM.
- Microwave Leak Detection Meter

CHANGES AND FEATURES OVERVIEW

For 2004/2005 some important new features and design changes have been introduced into our gas freestanding ranges. Below is a list of the most significant changes.

- LARGER OVEN CAPACITY - 5.0 cu. ft.
- FRONT MOUNTED LEVELING FEET FOR GREATER STABILITY
- IMPROVED DOOR HINGE DESIGN FOR EASIER DOOR REMOVAL
- EXPANDED **EOC** FAULT CODES FOR MORE ACCURATE DIAGNOSIS
- NEW BODY SIDE DESIGN AND SERVICE PROCEDURE.
- DEEP SUMP COOKTOP WITH AVAILABLE FIVE BURNER DESIGN *

*THESE FEATRUES NOT FOUND ON ALL MODELS

ABBREVIATIONS AND TERMS FOUND IN THIS MANUAL

EOC	= ELECTRONIC OVEN CONTROL
RTD	= RESISTANCE TEMPERATURE DEVICE (Temperature Sensor Probe)
GND	= GROUND
LED	= LIGHT EMITTING DIODE
BTU	= BRITISH THERMAL UNIT

Model Numbering System for Free-Standing, Slide-in & Drop-in Ranges

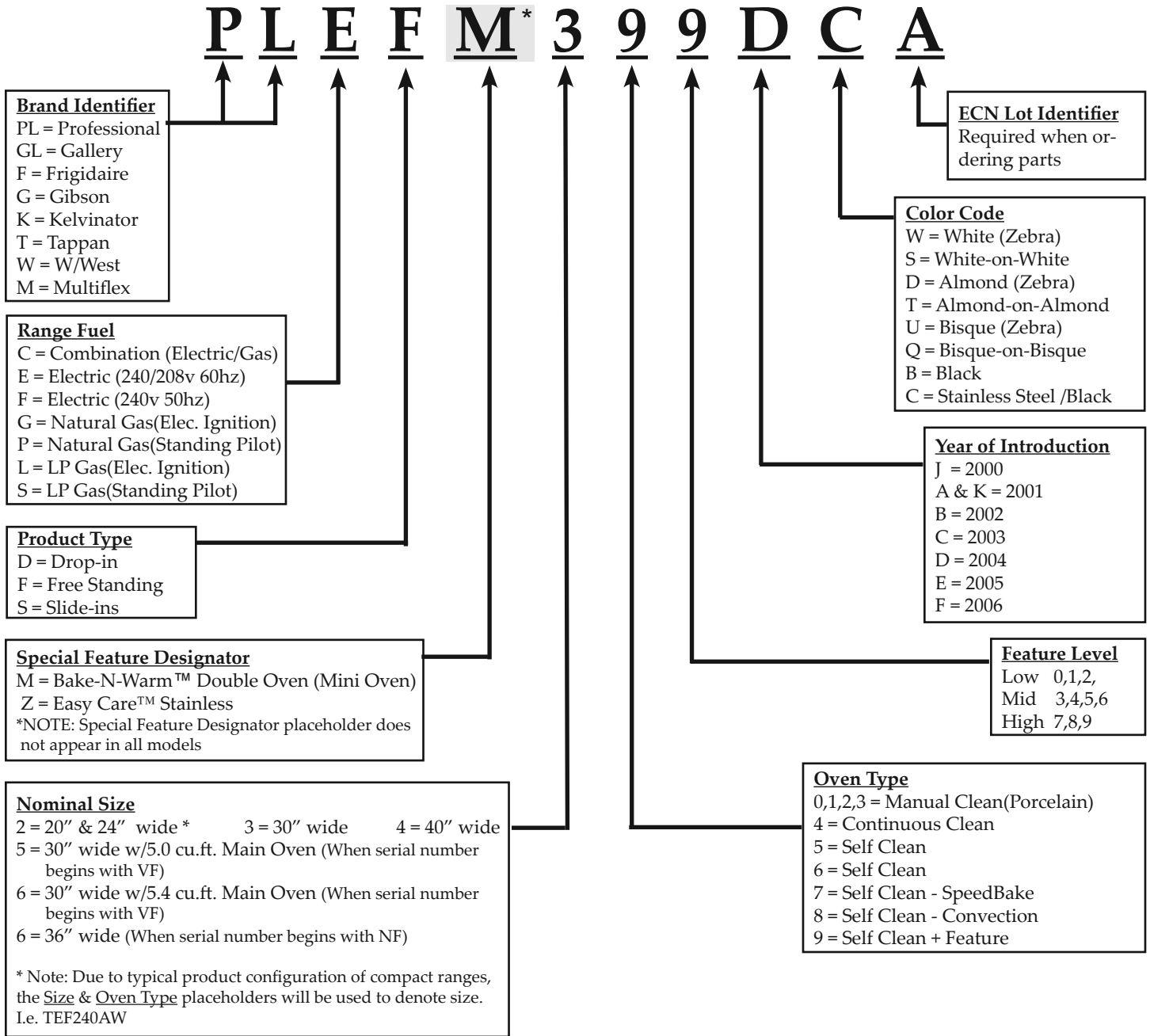

Country Specific Derivatives have a designated letter code placed as first digit of model number. Customer Specific Derivatives have a designated letter code following the Product Type digit.

Serial Numbering System

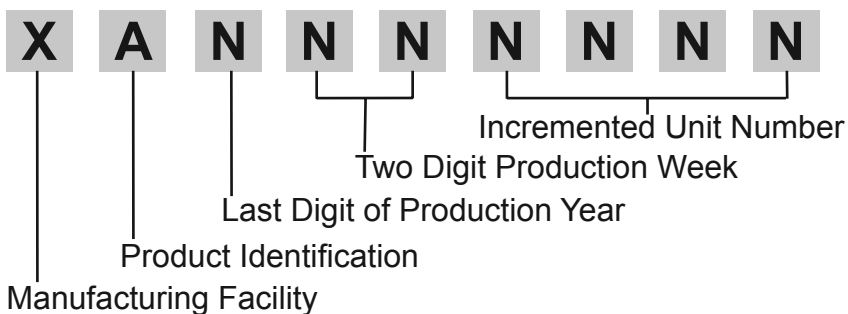

A = Alpha
 N = Numeric
 X = Either Alpha or Numeric

RANGE TECHNICAL DATA

Quick Reference Sheet

Maximum Allowable Surface Temperatures

All gas and electric ranges must comply with U.L. and A.N.S.I. surface temperature limits outlined in the following chart. Note that the testing temperature is different for electric ranges produced *after* 08/26/2003.

SURFACE TEMPERATURE LIMITS
1. Product must be undamaged, correctly assembled and have the correct oven temperature.
2. All skin temperatures are based on a room temperature of 77° F (25° C) and an oven set temperature of 400° F for gas and electric ranges built prior to 08/26/2003. Oven set temperature should be 475° F for electric products built after 8/26/2003.
3. Oven must be cycling at designated test temperature for one hour before test is conducted.
4. Pyrometers, (temperature testers), must be of high quality and properly adjusted.
5. An increase or decrease of 1° F in the room ambient temperature, will allow a 1° F increase or decrease in the maximum allowable surface temperature of the range.

LOCATION	MATERIAL TYPE / FINISH				
	PAINTED	PORCELAIN	GLASS	PLASTIC	METAL
Side Panel	152° F	160° F	—	—	—
Oven Door	152° F	160° F	172° F	182° F	—
Warmer Drawer Front Panel	152° F	160° F	—	—	—
Knobs & Handles	—	—	—	*167° F **182° F	131° F **152° F
Skirt	—	—	—	*182° F	*152° F
Cooktop Lower Console Oven Vent Area	NO TEMPERATURE LIMITS APPLY TO THIS AREA				

* Includes plastic with metal plating not more than 0.005" thick and metal with a plastic covering not less than 0.005" thick.
** Self-Clean Electric Range at Clean Temperature

RTD Temperature / Resistance Chart

The following chart can be used to test the resistance of the oven temperature sensor probe. For accuracy in testing use a high quality thermometer or temperature meter to determine actual oven temperature before reading the resistance of the probe.

RTD SCALE	
TEMPERATURE °F	RESISTANCE Ω
32 ± 1.9	1000 ± 4.0
75 ± 2.5	1091 ± 5.3
250 ± 4.4	1453 ± 8.9
350 ± 5.4	1654 ± 10.8
450 ± 6.9	1852 ± 13.5
550 ± 8.2	2047 ± 15.8
650 ± 13.6	2237 ± 18.5
900 ± 13.6	2697 ± 24.4

Removing and Replacing Warmer Drawer

To Remove Warmer Drawer:

1. Turn power off before removing the Warmer Drawer.
2. Open the drawer to the fully opened position.
3. Locate glide lever on each side of drawer, pull up on the left glide lever and push down on the right glide lever (see Figure 1).
4. Pull the drawer away from the range.

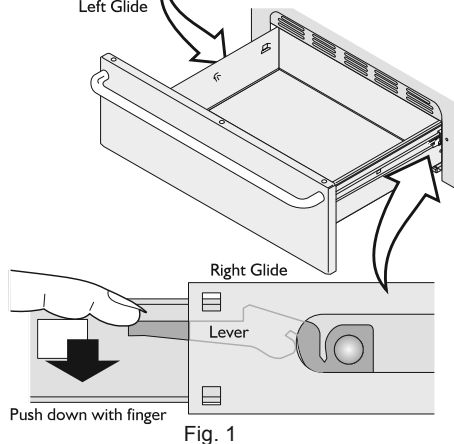
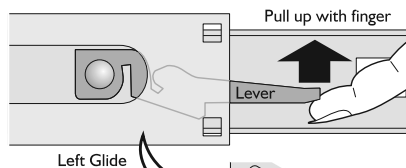

Warning

Electrical Shock Hazard can occur and result in serious injury or death. Disconnect appliance from electric power before cleaning and servicing the warmer drawer.

To Replace Warmer Drawer:

1. Pull the bearing glides to the front of the chassis glide (see Fig. 2).
2. Align the glide on each side of the drawer with the glide slots on the range.
3. Push the drawer into the range until levers "click" (approximately 2"). Pull the drawer open again to seat bearing glides into position. **If you do not hear the levers "click" or the bearing glides do not feel seated remove the drawer and repeat steps 1 thru 3.** This will minimize possible damage to the bearing glides.

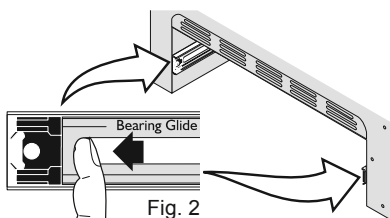

RANGE TECHNICAL DATA

GAS RANGE COMPONENT RESISTANCE CHART			
NOTE: RESISTANCE MEASUREMENTS ARE APPROXIMATE. VARIATIONS DUE TO TEMPERATURE CHANGES AND OTHER FACTORS ARE NORMAL.			
COMPONENT	VOLTAGE RATING	WATTAGE	RESISTANCE Ω (OHMS)
WARMER DRAWER ELEMENT	108 / 232	700	20.5 Ω
WARMER DRAWER ELEMENT	108 / 232	450	32 Ω
CONVECTION ELEMENT	108 / 232	350	40 Ω
CONVECTION FAN MOTOR WINDINGS	108 / 232		15 Ω
LOCK MOTOR WINDINGS	108 / 232		2000 Ω
GAS SAFETY VALVE	**		1.5 Ω
BAKE IGNITOR	108 / 232		100 Ω
BROIL IGNITOR	108 / 232		80 Ω
OVEN TEMPERATURE SENSOR PROBE (AT ROOM TEMPERATURE)	-		1100 Ω * *(REFER TO RTD CHART)

** Never apply line voltage to the oven safety valve terminals.

Oven Temperature Calibration

To test oven temperature set the electronic oven control for normal baking at 350°F. After the oven has completed the preheat cycle obtain an average oven temperature after a minimum of 5 cycles. Press **CANCEL** or **CLEAR** to end bake mode. If necessary calibrate the oven temperature. Information on adjusting the oven temperature can be found in the owners manual.

Note: Changing calibration affects all Baking modes. The adjustments made will not change the self-cleaning temperature.

RANGE TECHNICAL DATA

EOC Failure / Fault Codes

On freestanding gas and electric ranges manufactured beginning with the serial number date code **VF426** many of the EOC's will have expanded three digit fault codes. These codes may also appear in new replacement EOC's for ranges built prior to this date. Below is a list of possible fault codes that might appear in the EOC display window. The original two digit fault codes appear in the shaded boxes followed by the replacement three digit codes.

For each Fault code there is a listing of the likely failure condition or cause, as well as suggested corrective actions to be taken. Not all fault codes will appear in every model but the fault codes are universal and have the same meaning regardless of the model that is being serviced

Note: Fault codes are not a foolproof system. Never assume that a part has failed based on a displayed fault code. An example would be if the EOC is displaying F30 (open sensor), the failure could be caused by a loose connection or faulty wire harness between the EOC and sensor or the sensor could simply be unplugged.

FAULT CODE	LIKELY FAILURE CONDITION/CAUSE	SUGGESTED CORRECTIVE ACTION
F1	<ul style="list-style-type: none"> F10 Runaway Temperature. F11 Shorted Keypad. F12 Bad Micro Identification. F13 Bad EEPROM Identification/Checksum error. F14 Display tail missing/not connected 	<ol style="list-style-type: none"> 1. (F10 only) Check RTD Sensor Probe & replace if necessary. If oven is overheating, disconnect power. If oven continues to overheat when the power is reapplied, replace EOC. Severe overheating may require the entire oven to be replaced should damage be extensive. 2. (F11, 12 & 13) Disconnect power, wait 30 seconds and reapply power. If fault returns upon power-up, replace EOC. 3. (F14 only) Re-seat the P12 ribbon connector tail. If fault returns replace EOC (first action); Touch Panel (second action)
	<ul style="list-style-type: none"> F20 Communication failure between EOC and ESEC system. F26 Communication failure with mini oven control. 	<ol style="list-style-type: none"> 1. Test harness/connections P4 (EOC) & P11 (Surface element control board). 2. If harness checks O.K. failure can be caused by faulty UIB, surface element control board, or EOC. <p>Check harness and connectors from the EOC to mini oven control board. Check for 15vdc to mini oven control (red & gray wires). If harness and voltage are good replace mini oven control. If fault returns replace EOC.</p>
F3	<ul style="list-style-type: none"> F30 Open probe connection. F31 Shorted Probe connection 	<ol style="list-style-type: none"> 1. (F30 or F31) Check resistance at room temperature & compare to RTD Sensor resistance chart. If resistance does not match the RTD chart replace RTD Sensor Probe. Check Sensor wiring harness between EOC & Sensor Probe connector. 2. (F30 or F31) Check resistance at room temperature, if less than 500 ohms, replace RTD Sensor Probe. Check for shorted Sensor Probe harness between EOC & Probe connector.
	<ul style="list-style-type: none"> F40 Cooktop Lockout error. F41 	<ol style="list-style-type: none"> 1. (F40 or F41) Check the wiring. 2. (F40 or F41) Replace the Cooktop Lockout Control Board. 3. (F40 or F41) Replace EOC.
F9	<ul style="list-style-type: none"> F90 Maximum oven door unlock time exceeded. F91 Maximum oven door unlock attempts exceeded. F92 Maximum oven door open time exceeded. F93 Maximum oven door lock time exceeded. F94 Maximum oven door lock attempts exceeded. 	<ol style="list-style-type: none"> 1. (F90, 91, 92, 93 & 94) Check the wiring between EOC & Lock Motor Micro Switch. 2. (F90, 91, 92, 93 & 94) Replace the Motor Door Latch assembly if necessary. 3. (F90, 91, 92, 93 & 94) Check for binding of the Latch Cam, Lock Motor Rod & Lock Motor Cam. 4. (F90, 91, 92, 93 & 94) Check to see if Lock Motor Coil is open. If open, replace Lock Motor Assembly. 5. (F90, 91, 92, 93 & 94) Lock Motor continuously runs - if Micro Switch is open, replace Lock Motor Assembly. 6. (F92, 93 & 94) Check oven door Light Switch - if open, replace Switch. 7. If all situations above do not solve problem, replace EOC.

Gas Range Installation – Prevent Damage to Range Gas Tubing and Pressure Regulator

DELIVERY INSTALLATION BULLETIN

The procedure described below will prevent the deformation of the gas regulator mounting bracket and gas tubing leading to the gas regulator. Refer to the instructions provided with this range for complete installation instructions.

NOTE: Be sure to carefully follow the service procedure as described below. **Use NO MORE THAN 15 ft./lbs. of torque** when tightening the gas fittings and/or gas flexible appliance conduit to the gas regulator.

The gas regulator and associated gas lines should appear as in Fig. 1. You may then proceed with the gas installation by following the recommended procedures found in the **Installation Instructions** for the range.

It is unacceptable to continue with the gas service installation if the deformation to the gas lines is as shown in Fig. 2.

As an additional precaution perform the following instructions to avoid deformation of the gas lines and gas regulator mounting bracket:

1. **Stabilize** the left side of the gas regulator with an adjustable wrench as shown (See Fig. 3). PLEASE NOTE: Be careful not to damage the Gas Shut-Off Valve.
2. Tighten the gas supply fitting and/or gas flexible appliance conduit to the right side of the gas regulator using **15ft./lbs.** of torque (See Fig. 4).
3. Check to make sure the gas lines and the gas regulator mounting bracket are not deformed before supplying gas to the range.

NOTE: Also, check to make sure that the Gas Shut-Off Valve is still in the ON position (See Fig. 5).

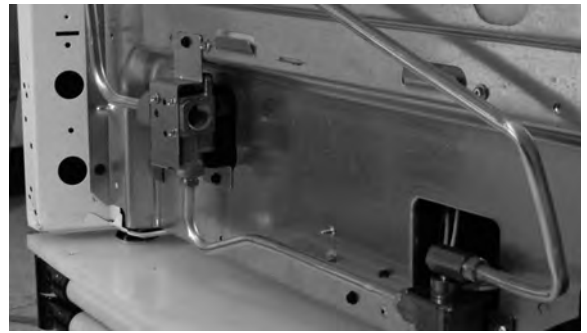

Fig. 1



Fig. 2



Fig. 3



Fig. 4

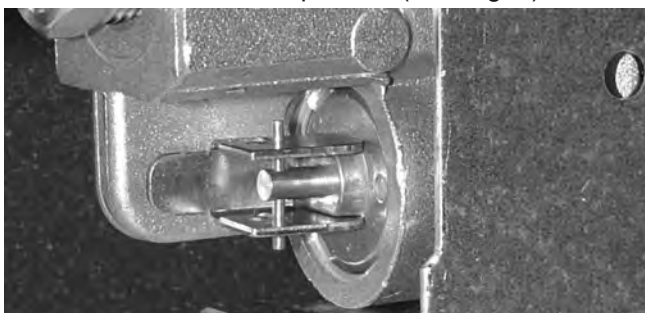

Fig. 5

30" GAS RANGE INSTALLATION INSTRUCTIONS

(For Models with Sealed Top burners)

**INSTALLATION AND SERVICE MUST BE PERFORMED BY A QUALIFIED INSTALLER.
IMPORTANT: SAVE FOR LOCAL ELECTRICAL INSPECTOR'S USE.
READ AND SAVE THESE INSTRUCTIONS FOR FUTURE REFERENCE.**

⚠ WARNING If the information in this manual is not followed exactly, a fire or explosion may result causing property damage, personal injury or death.

FOR YOUR SAFETY:

- Do not store or use gasoline or other flammable vapors and liquids in the vicinity of this or any other appliance.
- **WHAT TO DO IF YOU SMELL GAS:**
 - Do not try to light any appliance.
 - Do not touch any electrical switch; do not use any phone in your building.
 - Immediately call your gas supplier from a neighbor's phone. Follow the gas supplier's instructions.
 - If you cannot reach your gas supplier, call the fire department.
- Installation and service must be performed by a qualified installer, service agency or the gas supplier.



Refer to your serial plate for applicable agency certification



⚠ WARNING

- ALL RANGES CAN TIP
- INJURY TO PERSONS COULD RESULT
- INSTALL ANTI-TIP DEVICE PACKED WITH RANGE
- SEE INSTALLATION INSTRUCTIONS

Note: For appliances installed in the State of Massachusetts see page 2.

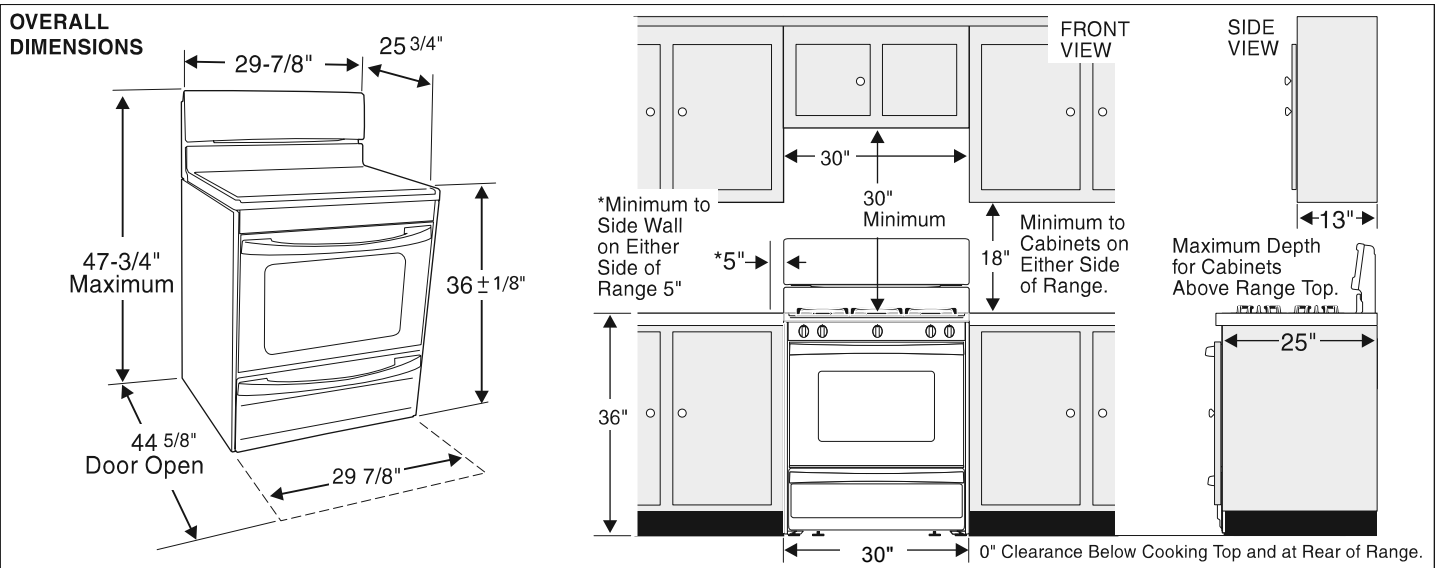

Clearances and Dimensions

1. **Location**—Check location where the range will be installed. Check for proper electrical and gas supply, and the stability of the floor.
2. **Dimensions** that are shown must be used. Given dimensions provide minimum clearance. Contact surface must be solid and level.

Provide Proper Fuel Type

Before Proceeding: Your range is preset to operate on natural gas.

⚠ CAUTION DO NOT attempt to convert this range to LP/Propane settings without the proper LP/Propane conversion kit provided with the range or obtained from your dealer. Follow all instructions provided with this conversion kit.

30" GAS RANGE INSTALLATION INSTRUCTIONS

(For Models with Sealed Top burners)

Important Notes to the Installer

1. Read all instructions contained in these installation instructions before installing range.
2. Remove all packing material from the oven compartments before connecting the gas and electrical supply to the range.
3. Observe all governing codes and ordinances.
4. Be sure to leave these instructions with the consumer.

Important Note to the Consumer

1. Keep these instructions with your Use & Care Guide for future reference.

IMPORTANT SAFETY INSTRUCTIONS

Installation of this range must conform with local codes or, in the absence of local codes, with the National Fuel Gas Code ANSI Z223.1—latest edition when installed in the United States.

When installed in a manufactured (mobile) home, installation must conform with the Manufactured Home Construction and Safety Standard, Title 24 CFR, Part 3280 [formerly the Federal Standard for Mobile Home Construction and Safety, Title 24, HUD (Part 280)] or, when such standard is not applicable, the Standard for Manufactured Home Installations, ANSI/NCSBCS A225.1, or with local codes.

This range has been design certified by CSA International. As with any appliance using gas and generating heat, there are certain safety precautions you should follow. You will find them in the Use & Care Guide, read it carefully.

- **Be sure your range is installed and grounded properly by a qualified installer or service technician.**
- **This range must be electrically grounded in accordance with local codes or, in their absence, with the National Electrical Code ANSI/NFPA No .70—latest edition when installed in the United States.** See Grounding Instructions on page 5.
- **Before installing the range in an area covered with linoleum or any other synthetic floor covering, make sure the floor covering can withstand heat at least 90°F above room temperature without shrinking, warping or discoloring.** Do not install the range over carpeting unless you place an insulating pad or sheet of 1/4-inch thick plywood between the range and carpeting.
- **Make sure the wall coverings around the range can withstand the heat generated by the range.**
- **Do not obstruct the flow of combustion air at the oven vent nor around the base or beneath the lower front panel of the range.** Avoid touching the vent openings or nearby surfaces as they may become hot while the oven is in operation. This range requires fresh air for proper burner combustion.

⚠ WARNING Never leave children alone or unattended in the area where an appliance is in use. As children grow, teach them the proper, safe use of all appliances. Never leave the oven door open when the range is unattended.

⚠ WARNING Stepping, leaning or sitting on the doors or drawers of this range can result in serious injuries and can also cause damage to the range.

- **Do not store items of interest to children in the cabinets above the range.** Children could be seriously burned climbing on the range to reach items.
- **To eliminate the need to reach over the surface burners, cabinet storage space above the burners should be avoided.**
- **Adjust surface burner flame size so it does not extend beyond the edge of the cooking utensil.** Excessive flame is hazardous.
- **Do not use the oven as a storage space.** This creates a potentially hazardous situation.
- **Never use your range for warming or heating the room.** Prolonged use of the range without adequate ventilation can be dangerous.
- **Do not store or use gasoline or other flammable vapors and liquids near this or any other appliance.** Explosions or fires could result.
- **Reset all controls to the "off" position after using a programmable timing operation.**

FOR MODELS WITH SELF-CLEAN FEATURE:

- **Remove broiler pan, food and other utensils before self-cleaning the oven.** Wipe up excess spillage. Follow the cleaning instructions in the Use & Care Guide.
- **Unlike the standard gas range, THIS COOKTOP IS NOT REMOVABLE.** Do not attempt to remove the cooktop.

Special instructions for appliances installed in the State of Massachusetts: This appliance can only be installed in the State of Massachusetts by a Massachusetts licensed plumber or gas fitter. When using a flexible gas connector, it must not exceed 3 feet (36 inches) in length. A "T" handle type manual gas valve must be installed in the gas supply line to this appliance.

⚠ WARNING DO NOT MAKE ANY ATTEMPT TO OPERATE THE ELECTRIC IGNITION OVEN DURING AN ELECTRICAL POWER FAILURE. RESET ALL OVEN CONTROLS TO "OFF" IN THE EVENT OF A POWER FAILURE.

The electric ignitor will automatically re-ignite the oven burner when power resumes if the oven thermostat control was left in the "ON" position.

When an electrical power failure occurs during use, the surface burners will continue to operate.

During a power outage, the surface burners can be lit with a match. Hold a lighted match to the burner, then slowly turn the knob to the LITE position. Use extreme caution when lighting burners this way.



30" GAS RANGE INSTALLATION INSTRUCTIONS

(For Models with Sealed Top burners)

Before Starting

Tools You Will Need

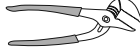
For leveling legs and Anti-Tip Bracket:

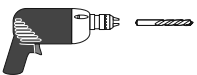
- Adjustable wrench or channel lock pliers 
- 5/16" Nutdriver or Flat Head Screw Driver 
- Electric Drill & 1/8" Diameter Drill Bit (5/32" Masonry Drill Bit if installing in concrete) 

For gas supply connection:

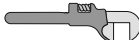
- Pipe wrench 

For burner flame adjustment:

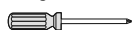
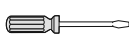
- Phillips head  and blade-type screwdrivers 

For gas conversion (LP/Propane or Natural):

- Open end wrench - 1/2" 

Additional Materials You Will Need

- Gas line shut-off valve 
- Pipe joint sealant that resists action of LP/Propane gas 

- A new flexible metal appliance conduit (1/2" NPT x 3/4" or 1/2" I.D.) must be design certified by CSA International. Because solid pipe restricts moving the range we recommend using a new flexible conduit (4 to 5 foot length) for each new installation and additional reinstallations. 

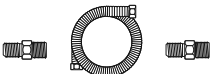
- Always use the (2) new flare union adapters (1/2" NPT x 3/4" or 1/2" I.D.) supplied with the new flexible appliance conduit for connection of the range. 

Normal Installation Steps

1. Anti-Tip Bracket Installation Instructions

Important Safety Warning

To reduce the risk of tipping of the range, the range must be secured to the floor by properly installed anti-tip bracket and screws packed with the range. Failure to install the anti-tip bracket will allow the range to tip over if excessive weight is placed on an open door or if a child climbs upon it. Serious injury might result from spilled hot liquids or from the range itself.

If range is ever moved to a different location, the anti-tip brackets must also be moved and installed with the range.

Instructions are provided for installation in wood or cement fastened to either the floor or wall. When installed to the wall, make sure that screws completely penetrate dry wall and are secured in wood or metal. When fastening to the floor or wall, be sure that screws do not penetrate electrical wiring or plumbing.

- A. Locate the Bracket Using the Template** - (Bracket may be located on either the left or right side of the range. Use the information below to locate the bracket if template is not available). Mark the floor or wall where left or right side of the range will be located. If rear of range is against the wall or no further than 1-1/4" from wall when installed, you may use the wall or floor mount method. If molding is installed and does not allow the bracket to fit flush against the wall, remove molding or mount bracket to the floor. For wall mount, locate the bracket by placing the back edge of the template against the rear wall and the side edge of template on the mark made referencing the side of the range. Place bracket on top of template and mark location of the screw holes in wall. If rear of range is further than 1-1/4" from the wall when installed, attach bracket to the floor. For floor mount, locate the bracket by placing back edge of the template where the rear of the range will be located. Mark the location of the screw holes, shown in template.

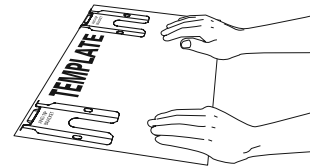

- B. Drill Pilot Holes and Fasten Bracket** - Drill a 1/8" pilot hole where screws are to be located. If bracket is to be mounted to the wall, drill pilot hole at an approximate 20° downward angle. If bracket is to be mounted to masonry or ceramic floors, drill a 5/32" pilot hole 1-3/4" deep. The screws provided may be used in wood or concrete material. Use a 5/16" nut-driver or flat head screwdriver to secure the bracket in place.

FASTEN BRACKET (WALL OR FLOOR MOUNTING)

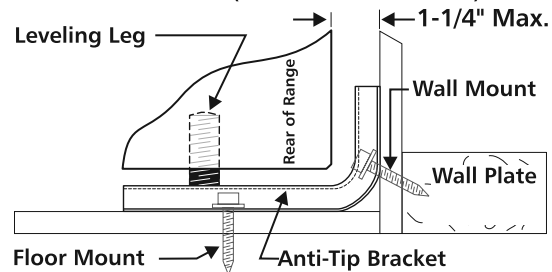

FASTEN BRACKET (FLOOR MOUNTING ONLY)

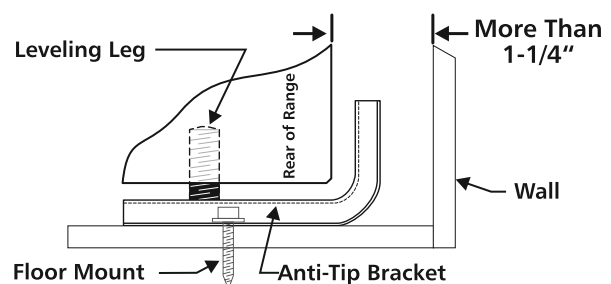

30" GAS RANGE INSTALLATION INSTRUCTIONS

(For Models with Sealed Top burners)

C. Level and Position Range - Level range by adjusting the (4) leveling legs with a wrench. Note: A minimum clearance of 1/8" is required between the bottom of the range and the leveling leg to allow room for the bracket. Use a spirit level to check your adjustments. Slide range back into position. Visually check that rear leveling leg is inserted into and fully secured by the Anti-Tip Bracket by removing lower panel or storage drawer. For models with a warmer drawer or broiler compartment, grasp the top rear edge of the range and carefully attempt to tilt it forward.

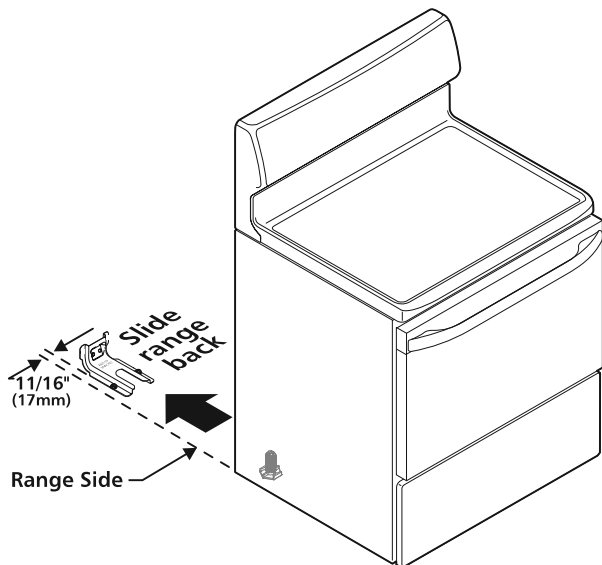

2. Provide an adequate gas supply.

This unit is pre-set to operate on 4" natural gas manifold pressure. A convertible pressure regulator is connected to the manifold and MUST be connected in series with the gas supply line. If the LP/Propane conversion kit has been used, follow instructions provided with the kit for converting the pressure regulator to LP/Propane use. The LP kit can be found on the back side of the range (some models).

Care must be taken during installation of range not to obstruct the flow of combustion and ventilation air.

For proper operation, the maximum inlet pressure to the regulator should be no more than 14 inches of water column pressure. The inlet pressure to the regulator must be at least 1 inch greater than regulator manifold pressure. Examples: If regulator is set for natural gas 4 inch manifold pressure, inlet pressure must be at least 5 inches; if regulator has been converted for LP/Propane gas 10 inch manifold pressure, inlet pressure must be at least 11 inches.

Leak testing of the appliance shall be conducted according to the instructions in step 4g.

The gas supply line should be 1/2" or 3/4" I.D.

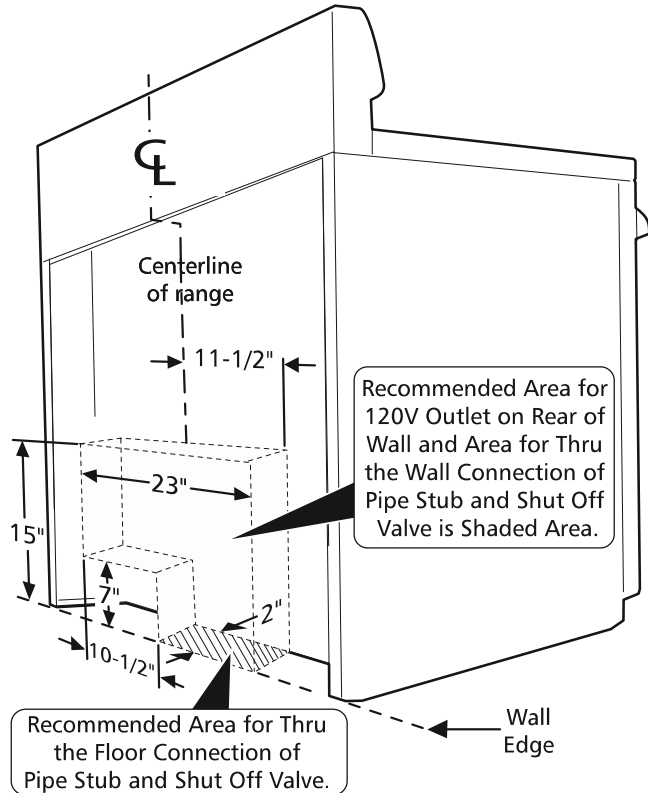

3. Seal the openings.

Seal any openings in the wall behind the range and in the floor under the range after gas supply line is installed.

4. Connect the range to the gas supply.

To prevent leaks, put a pipe joint sealant on all male (outside) pipe threads.

Your regulator is in the location shown below.

CAUTION Do not allow regulator to turn on pipe when tightening fittings.

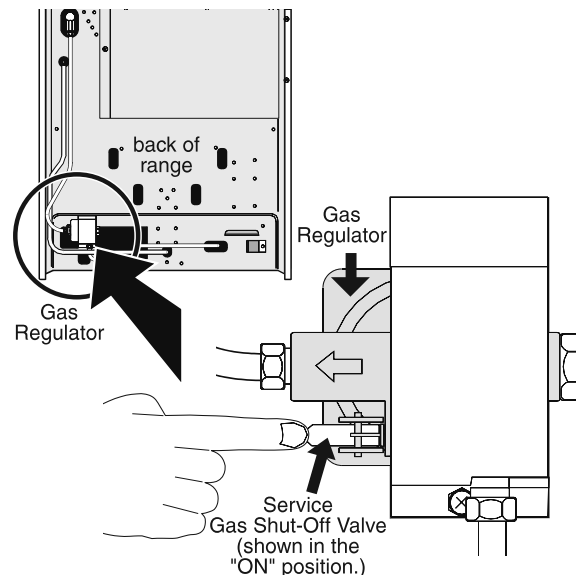

30" GAS RANGE INSTALLATION INSTRUCTIONS

(For Models with Sealed Top burners)

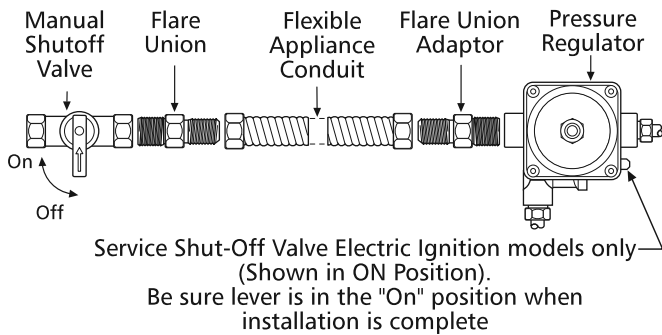

- Install an external manual gas shut-off valve to gas supply line in an easily-accessible location outside of the range. Be sure you know how and where to shut-off the gas supply to the range.
- Install 1/2" flare union adaptor to pressure regulator.
- Attach appliance conduit to flare union on regulator.
- Install flare union adaptor to external manual shut-off valve.
- Attach appliance conduit to flare union on shut-off valve.
- Make sure service shut-off valve on pressure regulator is in the "ON" position.**
- Check for leaks. Turn the gas supply on to the range and use a liquid leak detector at all joints and conduits to check for leaks in the system.

⚠ WARNING Do not use a flame to check for gas leaks.

Checking Manifold Gas Pressure

Disconnect the range and its individual shut-off valve from the gas supply piping system during any pressure testing of that system at test pressures greater than 14" of water column pressure (approximately 1/2" psig).

The appliance must be isolated from the gas supply piping system by closing its individual manual shut-off valve during any pressure testing of the gas supply piping system at test pressures equal to or less than 14" of water column pressure (approximately 1/2" psig).

If it should be necessary to check the manifold gas pressure, connect manometer (water gauge) or other pressure device to the top burner right rear orifice. Using a rubber hose with inside diameter of approximately 1/4," hold tubing down tight over orifice. Turn burner valve on.

For an accurate pressure check have at least two (2) other top burners burning. Be sure the gas supply (inlet) pressure is at least one inch above specified range manifold pressure. The gas supply pressure should never be over 14" water column. When properly adjusted for Natural Gas the manifold pressure is 4." (For LP/Propane Gas the manifold pressure is 10.")

5. Read electrical connection details below and connect electricity to range.

⚠ WARNING Before servicing, disconnect electrical supply at circuit breaker, fuse or power cord.

Electric Requirements: A dedicated, properly grounded and polarized branch circuit protected by a 15 amp. circuit breaker or time delay fuse. See serial plate for proper voltage.

Extension Cord Precautions:

Because of potential safety hazards under certain conditions, we strongly recommend against the use of any extension cord. However, if you still elect to use an extension cord, it is absolutely necessary that it be a UL listed 3-wire grounding type appliance extension cord and that the current carrying rating of the cord in amperes be equivalent to or greater than the branch circuit rating. Such extension cords are obtainable through your local service organization.

⚠ WARNING PLEASE READ CAREFULLY! For personal safety, this product must be properly grounded.

Grounding Instructions

The power cord of this appliance is equipped with a 3-prong (grounding) plug which mates with a standard 3-prong grounding wall receptacle to minimize the possibility of electric shock hazard from this appliance. The customer should have the wall receptacle and circuit checked by a qualified electrician to make sure the receptacle is properly grounded and polarized.

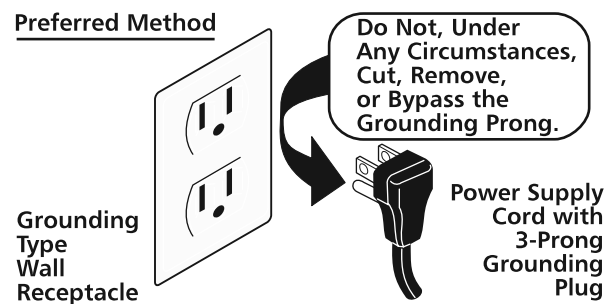

Where a standard two-prong wall receptacle is encountered, it is the personal responsibility and obligation of the customer to have it replaced with a properly grounded three-prong wall receptacle.

DO NOT, UNDER ANY CIRCUMSTANCES, CUT OR REMOVE THE THIRD (GROUND) PRONG FROM THE POWER CORD.

30" GAS RANGE INSTALLATION INSTRUCTIONS

(For Models with Sealed Top burners)

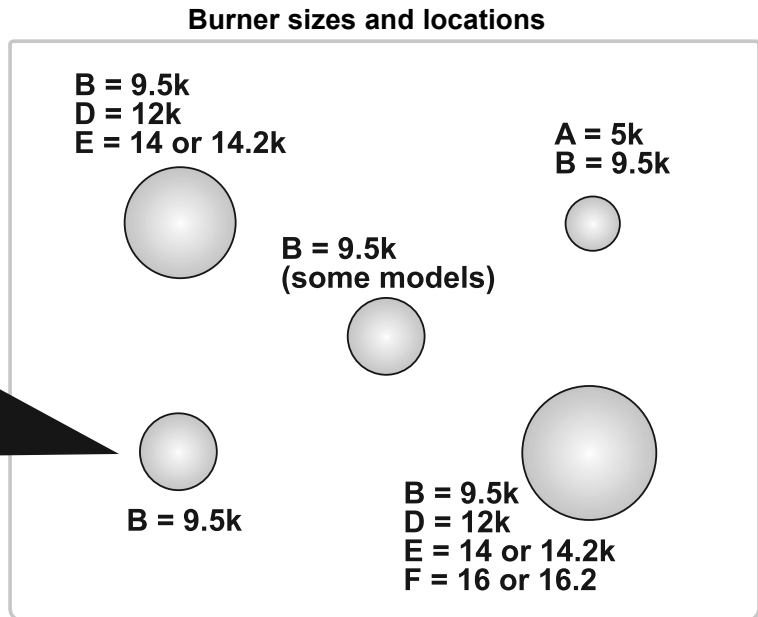
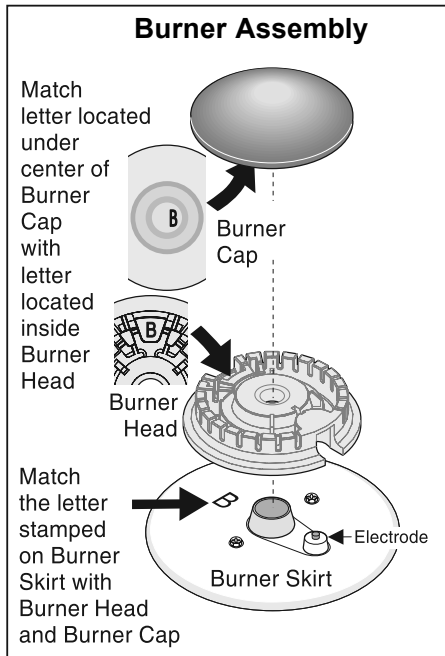

Fig. 1

Front of cooktop

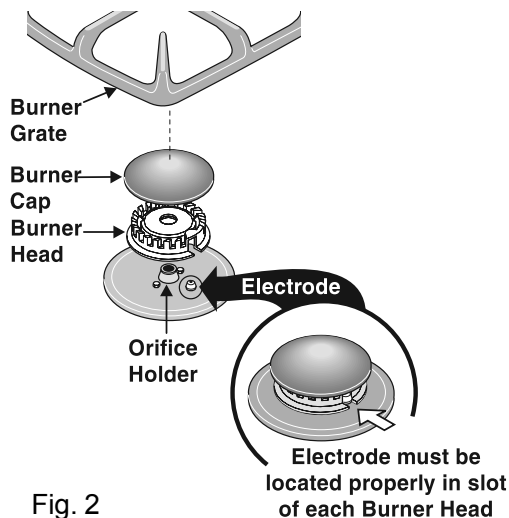

Fig. 2

6. Assembly of the Surface Burner Heads, Burner Caps and Burner Grates:

It is very important to make sure that all of the Surface Burner Heads, Surface Burner Caps and Surface Burner Grates are installed correctly and in the correct locations (See Fig. 1).

1. Match the letter located under center of Burner Cap with letters located inside the Burner Heads (See Fig. 1).
2. Match the letter stamped on the Burner Skirt with the Burner Head and Burner Cap. Each of the Burner Heads **MUST** have a Burner Cap installed to insure proper ignition and gas flame size. Note: The Burner Electrodes must be located properly in slot of each Burner Head (See Fig. 2).

REMEMBER — DO NOT ALLOW SPILLS, FOOD, CLEANING AGENTS OR ANY OTHER MATERIAL TO ENTER THE GAS ORIFICE HOLDER OPENING. Always keep the Burner Caps and Burner Heads in place whenever the surface burners are in use.

7. Electric Ignition Surface Burners

Operation of electric igniters should be checked after range and supply line connectors have been carefully checked for leaks and range has been connected to electric power.

- a. To check for proper lighting, **push in and turn** a surface burner knob **counterclockwise** to the **LITE** position. You will hear the igniter sparking (See Fig. 3).
- b. The surface burner should light when gas is available to the top burner. Purge air from supply lines by leaving knob in the **LITE** position until burner ignites. Each burner should light within four (4) seconds in normal operation after air has been purged from supply lines.
- c. Visually check that burner has lit. Once the burner lights, the control knob should be turned out of the **LITE** position.
- d. There are separate electrodes (igniters) for each burner. Try each knob separately until all burner valves have been checked.

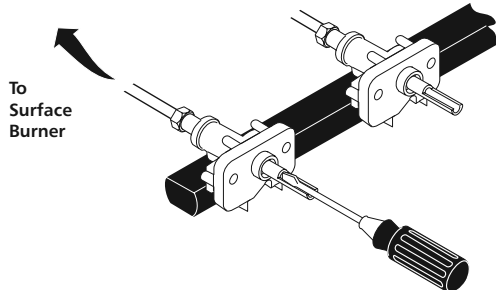

Fig. 3

30" GAS RANGE INSTALLATION INSTRUCTIONS

(For Models with Sealed Top burners)

8. Adjust the "LOW" Setting of Surface Burner Valve (Linear Flow Valves Only):



Test to verify if "LOW" setting should be adjusted

- Push in and turn control to LITE until burner ignites.
- Push in and quickly turn knob to LOWEST POSITION.
- If burner goes out, reset control to OFF.
- Remove the surface burner control knob.
- Insert a thin-bladed screwdriver into the hollow valve stem and engage the slotted screw inside. Flame size can be increased or decreased with the turn of the screw. Turn counterclockwise to increase flame size. Turn clockwise to decrease flame size.

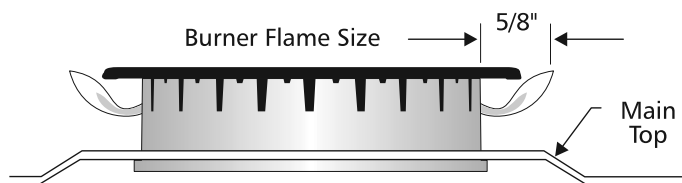

Adjust flame until you can quickly turn knob from LITE to LOWEST POSITION without extinguishing the flame. Flame should be as small as possible without going out.

Note: Air mixture adjustment is not required on surface burners.

Operation of Oven Burners and Oven Adjustments

9. Electric Ignition Burners

Operation of electric igniters should be checked after range and supply line connectors have been carefully checked for leaks and range has been connected to electric power.

The oven burner is equipped with an electric control system as well as an electric oven burner igniter. If your model is equipped with a waist-high broil burner, it will also have an electric burner igniter. These control systems require no adjustment. When the oven is set to operate, current will flow to the igniter. It will "glow" similar to a light bulb. When the igniter has reached a temperature sufficient to ignite gas, the electrically controlled oven valve will open and flame will appear at the oven burner. There is a time lapse from 30 to 60 seconds after the thermostat is turned ON before the flame appears at the oven burner. When the oven reaches the dial

setting, the glowing igniter will go off. The burner flame will go "out" in 20 to 30 seconds after the igniter goes "OFF." To maintain any given oven temperature, this cycle will continue as long as the dial (or display) is set to operate.

After removing all packing materials and literature from the oven:

- Set oven to BAKE at 300°F. See Use & Care Guide for operating instructions.
- Within 60 seconds the oven burner should ignite. Check for proper flame, and allow the burner to cycle once. Reset controls to off.
- If your model is equipped with a waist-high broiler, set oven to BROIL. See Use & Care Guide for operating instructions.
- Within 60 seconds the broil burner should ignite. Check for proper flame. Reset controls to off.

10. Air Shutter-Oven Burner

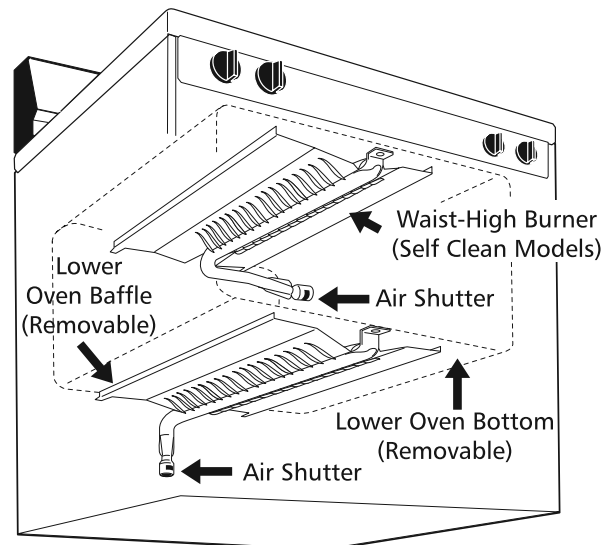

The approximate flame length of the oven burner is 1 inch (distinct inner, blue flame).

To determine if the oven burner flame is proper, remove the oven bottom and burner baffle and set the oven to bake at 300°F.

To remove the oven bottom, remove oven hold down screws at rear of oven bottom. Pull up at rear, disengage front of oven bottom from oven front frame, and pull the oven bottom out of the oven. Remove burner baffle so that the burner flame can be observed.

If the flame is yellow in color, increase air shutter opening size. (See "2" in illustration below.) If the flame is a distinct blue, reduce the air shutter opening size.

To adjust loosen lock screw (see "3" illustration below), reposition air shutter, and tighten lock screw. Replace oven bottom.

30" GAS RANGE INSTALLATION INSTRUCTIONS

(For Models with Sealed Top burners)

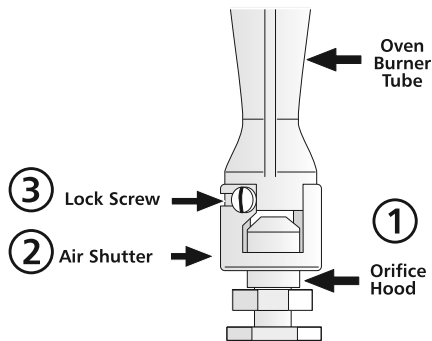

11. Air Shutter-Broil Burner

The approximate flame length of the broil burner is 1 inch (distinct inner, blue flame).

To determine if the broil burner flame is proper, set the oven to broil.

If the flame is yellow in color, increase air shutter opening size. (See "2" in illustration above.) If the flame is a distinct blue, reduce the air shutter opening size.

To adjust, loosen lock screw (see "3" in illustration above), reposition air shutter, and tighten lock screw.

12. Make Sure Range is Level.

Level the range by placing a level horizontally on an oven rack. Check diagonally from front to back, then level the range by either adjusting the leveling legs or by placing shims under the corners of the range as needed.

13. After installation is complete, make sure all controls are left in the OFF position.

Model and Serial Number Location

For sealed burner ovens, the identification plate is located on the right-hand surface of the oven front frame at the storage or warmer drawer; or the lower panel area.

When ordering parts for or making inquiries about your range, always be sure to include the model and serial numbers and a lot number or letter from the identification plate on your range.

Your identification plate also tells you the rating of the burners, the type of fuel and the pressure the range was adjusted for when it left the factory.

Care, Cleaning and Maintenance

Refer to the Use & Care Guide for cleaning instructions.

If removing the range is necessary for cleaning or maintenance, shut off gas supply. Disconnect the gas and electrical supply. If the gas or electrical supply is inaccessible, lift the unit slightly at the front and pull out away from the wall. Pull only as far as necessary to disconnect the gas and electrical supply. Finish removing the unit for servicing and cleaning. Reinstall in reverse order making sure to level the range and check gas connections for leaks. See page 3, step 1 for proper anchoring instructions.

Before You Call for Service

Read the "Before You Call" and operating instruction sections in your Use & Care Guide. It may save you time and expense. The list includes common occurrences that are not the result of defective workmanship or materials in this appliance.

Refer to the warranty in your Use & Care Guide for our toll-free service number and address. Please call or write if you have inquiries about your range product and/or need to order parts.

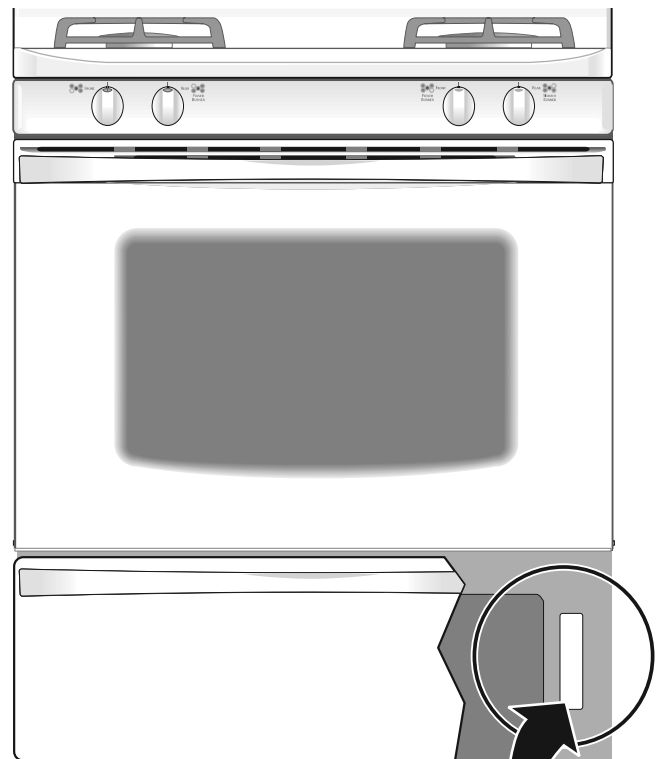

Open warmer drawer.
Serial plate location is here

GAS RANGE COOKTOP STYLES

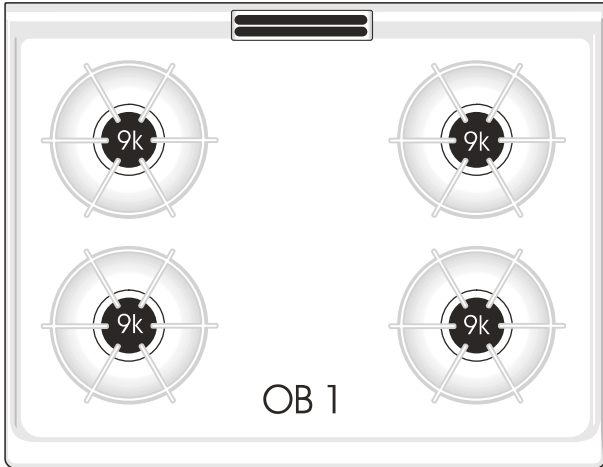

SLAB TOP / WIRE GRATES / VENTURI

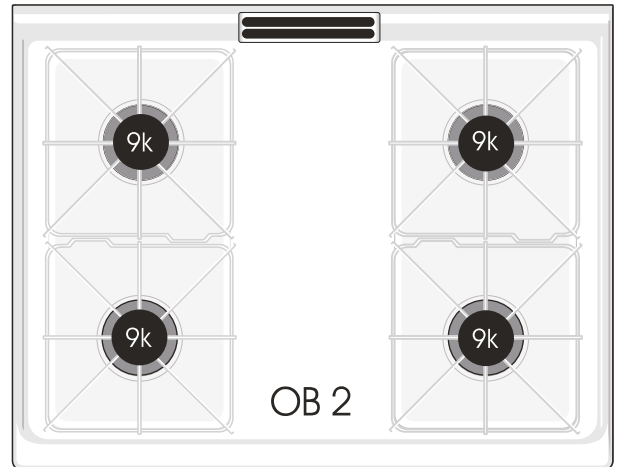

SLAB TOP / WIRE GRATES / VENTURI

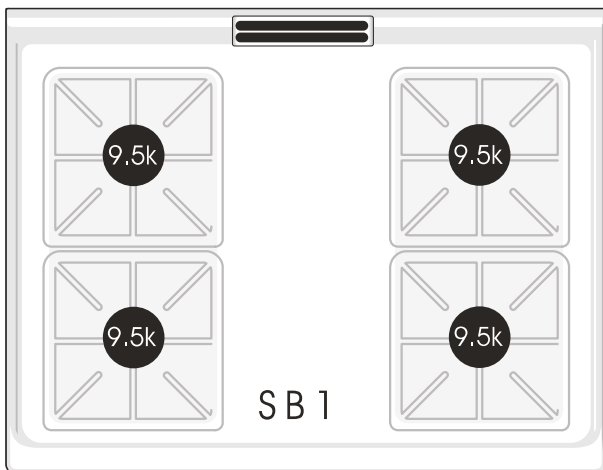

SLAB TOP / CAST GRATES / SEALED

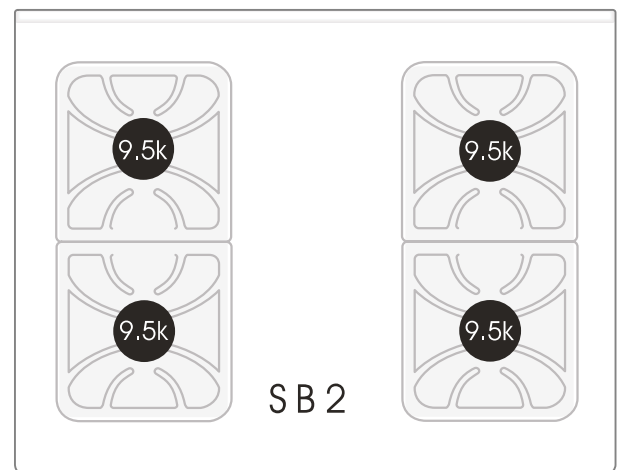

UPSWEPT TOP / CAST GRATES

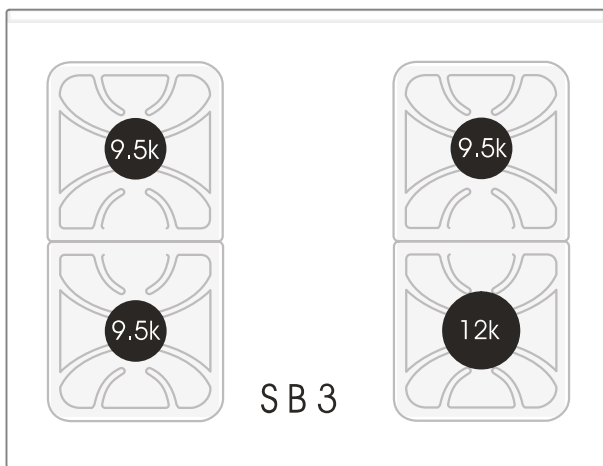

UPSWEPT TOP / CAST GRATES

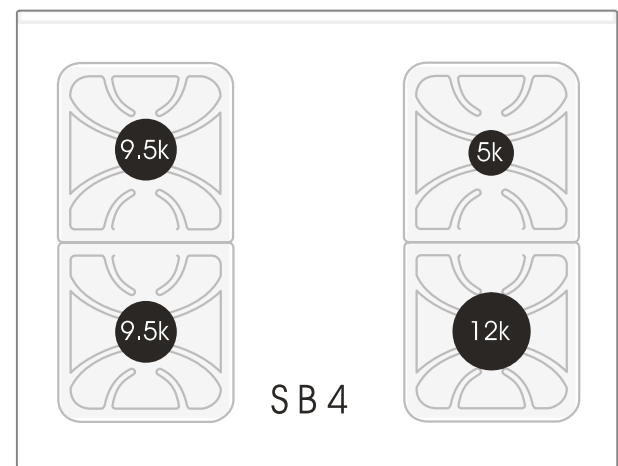

UPSWEPT TOP / CAST GRATES

GAS RANGE COOKTOP STYLES

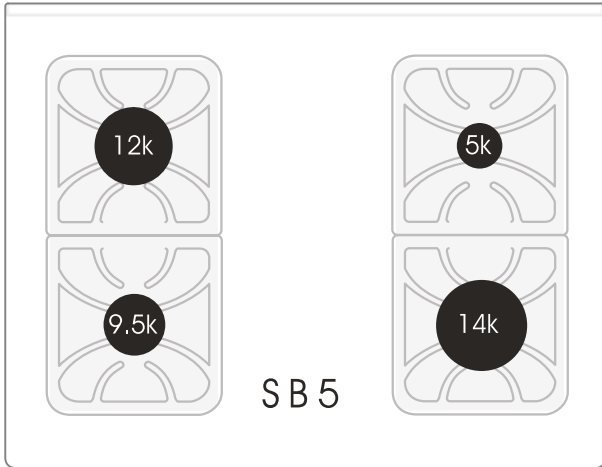

UPSWEPT TOP / CAST GRATES

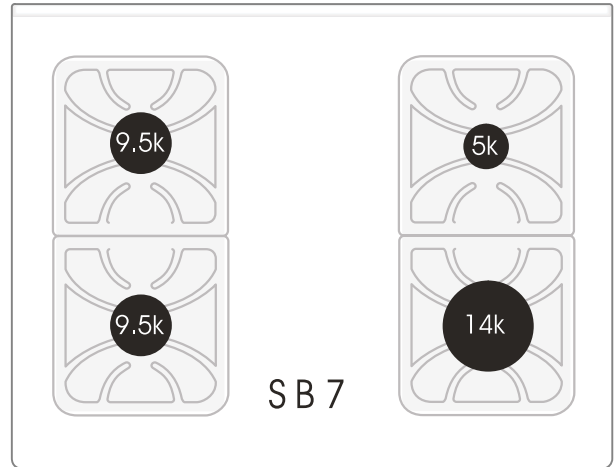

UPSWEPT TOP / CAST GRATES

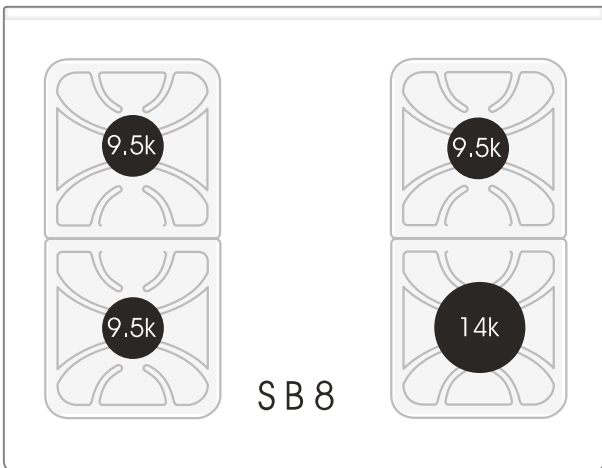

UPSWEPT TOP / CAST GRATES

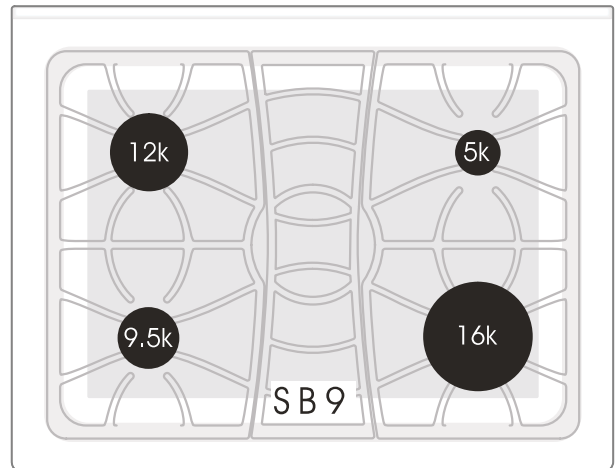

DEEP DRAWN / UPSWEPT TOP / CAST GRATES

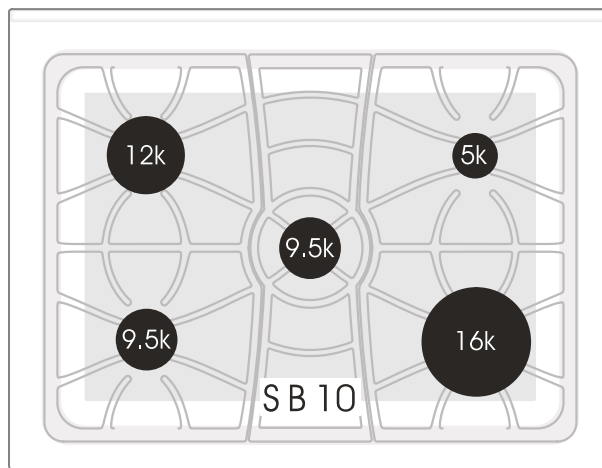

DEEP DRAWN / UPSWEPT TOP / CAST GRATES

COOKTOP SERVICING

Removing And Replacing Cooktop (Sealed Burner Models)

Warning DISCONNECT OR TURN OFF ALL ELECTRICAL POWER AND GAS SUPPLY BEFORE SERVICING APPLIANCE

The photographs and instructions in this section will guide you in the disassembly and replacement of the cooktop, surface burner orifice assembly, manifold panel, manifold and surface burner control valves on gas ranges with sealed surface burners.

To remove the main top first remove the grates, burner caps and burners. Using a 1/4" socket wrench or nut driver remove the mounting screws at each burner orifice assembly. (Photo 1)

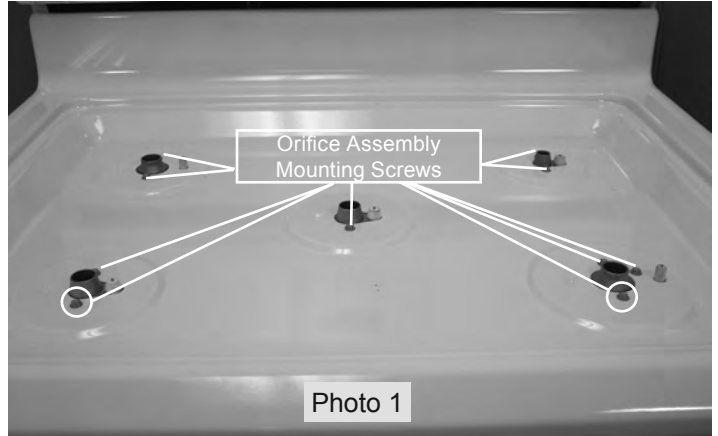

Insert a putty knife or similar tool between the main top and manifold panel near the outside of the front corner. Push the putty knife toward the rear to release the maintop mounting clip. Repeat for both sides. (Photo 2)



When the mounting clips are released the front edge of the cooktop can be lifted. Make sure that the orifice assembly does not bind in the cooktop when raising the top to remove it from the range. (Photo 3)

MAINTOP MOUNTING CLIP

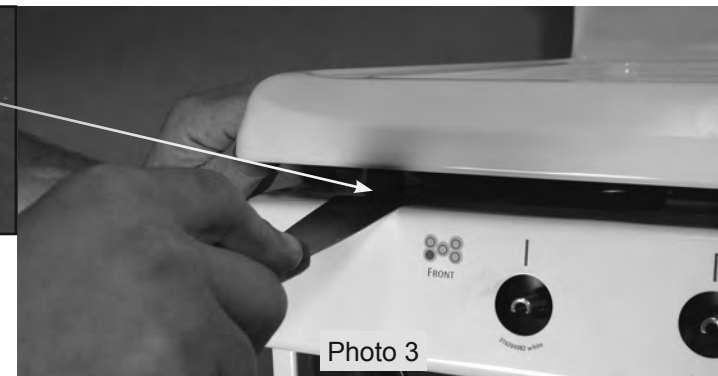
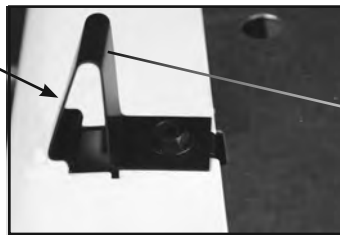

Lift the front of the cooktop and pull forward to disengage the back edge from the rear hinge bracket. The cooktop can now be replaced by reversing the previous steps. (Photo 4)

Rear Hinge Bracket

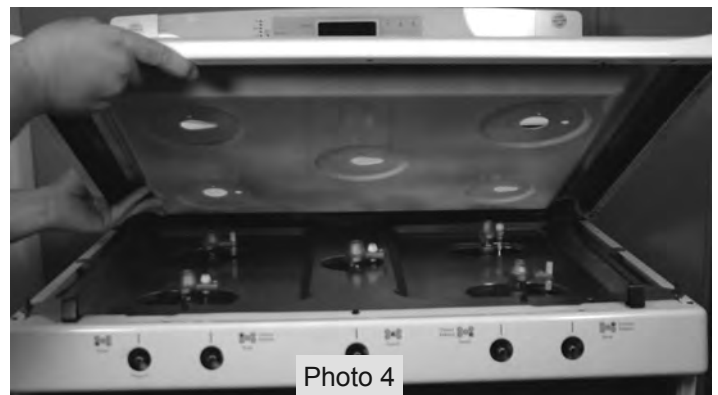

Removing & Replacing Manifold Panel and Burner Box

Once the cooktop has been removed the manifold panel and burner box can be removed to access the manifold, burner control valves, and orifice holder assemblies.

Removing Manifold Panel

Remove the four mounting screws on the underside of the manifold panel. Remove the burner valve control knobs by pulling them straight forward off the valve shafts.



Next remove the three 1/4" hex head screws securing the top of the manifold panel and remove the panel.

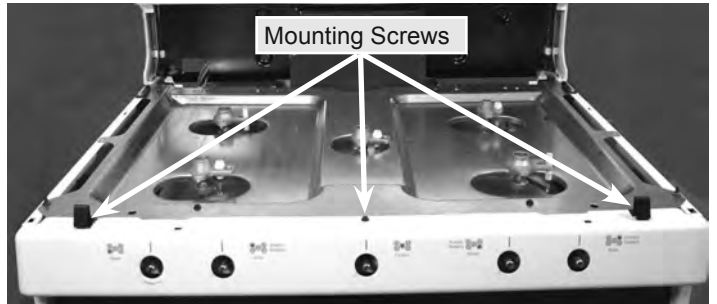

With the manifold panel removed the surface burner ignitor switches and harness are accessible. The wire harness and switches are replaced as a complete assembly.

To remove the switches and harness from the burner valves loosen the wire twist ties that secure the wire harness to the manifold pipe. Pull forward to unsnap the switch housing from the valve. When replacing the switches make sure that the switches snap securely and lock to the valve body. The slack in the wire harness should lay under the manifold tube and secure with the wire twist ties as shown in the photo.

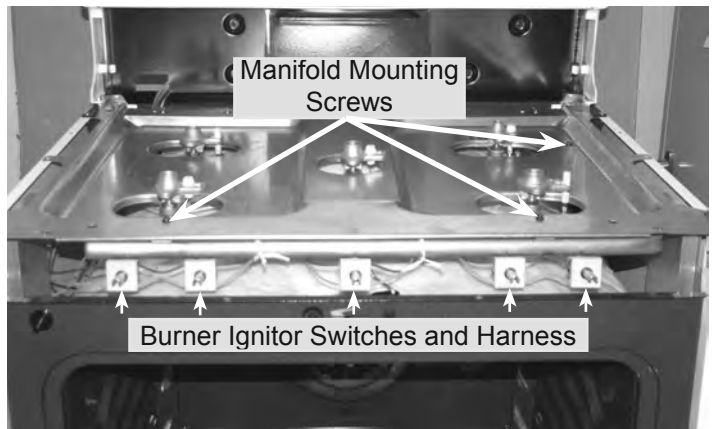

Removing Burner Box

Remove the three 1/4" hex head screws that secure the manifold assembly to the burner box. Carefully lower the manifold assembly on to the top of the oven insulation.

Using a 3/16" socket wrench or nut driver unscrew and remove the two front guide pins. Next remove the left and right rear hinge brackets.



Remove the four sheet metal screws that secure the back edge of the burner box to the rear main panel and lift the burner box off the range.

With the burner box removed the manifold pipe, surface burner valves, burner orifice assemblies and door latch hook assembly are accessible for service.

Removing and Replacing Orifice Holders

BEFORE ATTEMPTING TO REMOVE THE ORIFICE HOLDER ASSEMBLY OR BURNER VALVES MAKE SURE THAT THE GAS SUPPLY TO THE RANGE IS TURNED OFF.

The orifice holder and gas line are one assembly. To remove the orifice holder assembly disconnect the compression nut that secures the gas line to the burner valve. The orifice assembly should now be completely free from the range.

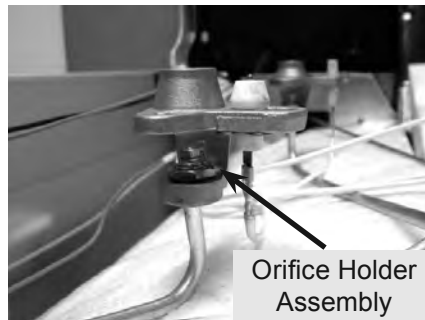

Removing and Replacing Surface Burner Valves

Disconnect the compression nut that secures the orifice assembly gas line to the valve.

Remove the valve mounting screw from the top side of the manifold tube. The valve can now be pulled out of the manifold tube from the bottom.

IMPORTANT NOTE: When reinstalling the burner valve always insure that the washer on the burner screw and valve body is undamaged and properly positioned

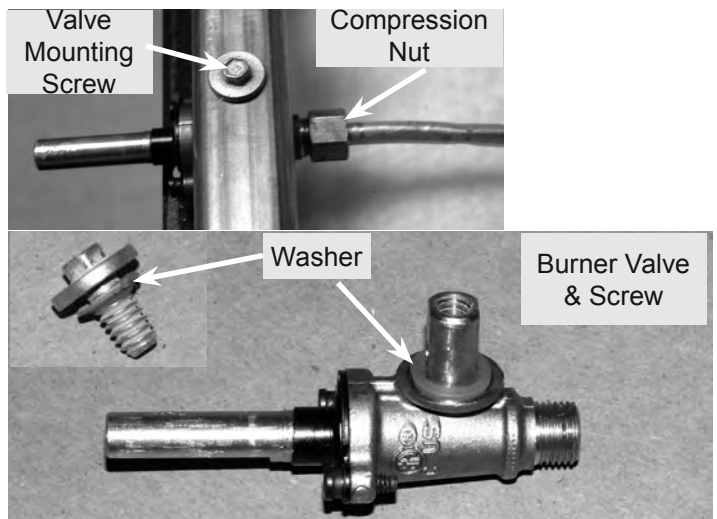

Removing Door Latch Hook Assembly

To remove the door latch hook assembly remove the two screws that secure it to the front oven chassis.

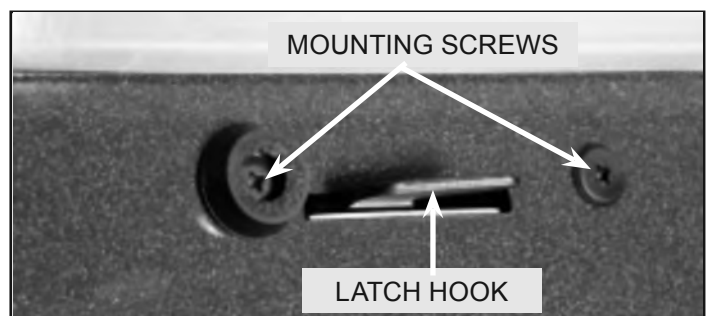

After the screws are removed the latch hook assembly can be removed from the chassis and the connecting rod can be disengaged.



Replacing Oven Door Light Switch

The oven door light switch is mounted to the front of the oven chassis near the top left corner of the door opening. To access the door switch the cooktop and burner box must be removed.

Carefully disconnect the wires to the switch and compress the spring locking clips that secure the switch to the frame. The switch can now be pulled forward from the mounting hole.

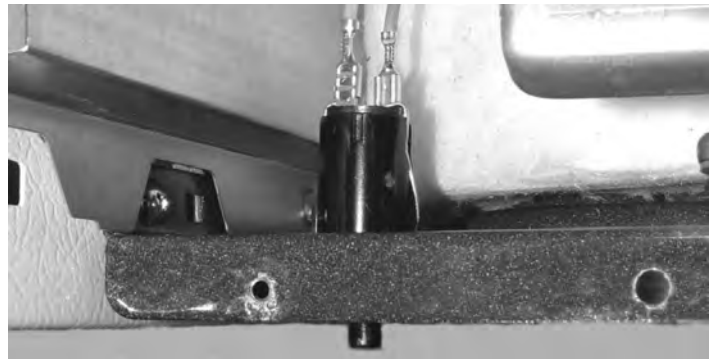

SERVICING OVEN BURNERS AND COMPONENTS

The bake and broil burners, convection fan blade and cover, oven bottom and interior oven lights are accessible for service from the front of the range.

Convection Fan Blade Cover

To access the convection fan blade remove the two screws that secure the convection fan blade cover and remove the cover.

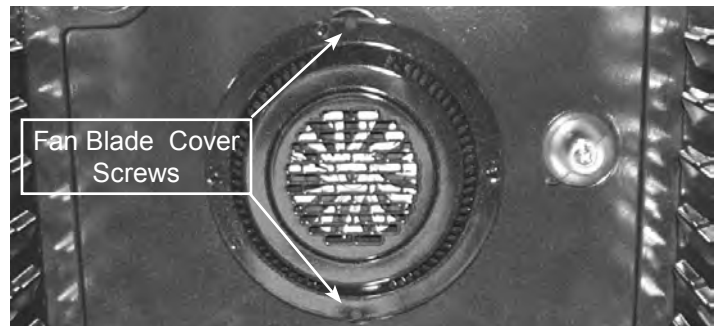

Removing Oven Bottom

With the fan blade cover removed take out the two screws at the rear of the oven bottom panel.

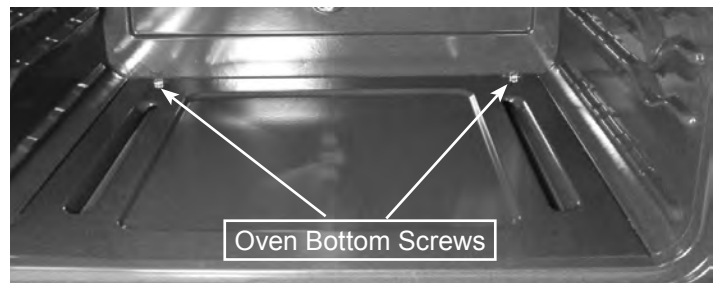

Lift the rear of the oven bottom up approximately 3 inches and slide the panel toward the rear of the range to disengage the front edge from the slot in the front frame.



Lift the front edge of the panel above the edge of the front frame and remove the oven bottom panel .



SERVICING OVEN BURNERS AND COMPONENTS

Servicing Bake Burner and Ignitor

Remove the two screws securing the front of the bake burner baffle to the range chassis. Lift the front edge of the baffle high enough to clear the chassis and pull forward to disengage the rear tabs on the baffle from the slots in the oven liner. Remove the baffle from the oven cavity.

With the baffle removed the bake burner and ignitor can be accessed for service.

Remove the warmer drawer per the instructions on page 7. With the warmer drawer removed the wire harness plug connector for the ignitor can be disconnected.

When replacing the bake burner ignitor it is necessary to remove the burner assembly.

After the ignitor harness plug is disconnected remove the two burner mounting screws and lift the burner assembly out of the range. The ignitor can now be separated from the bake burner assembly by removing the two ignitor mounting screws.

When reinstalling the burner assembly make sure to properly position the base of the burner tube over the orifice spud on the oven gas safety valve.

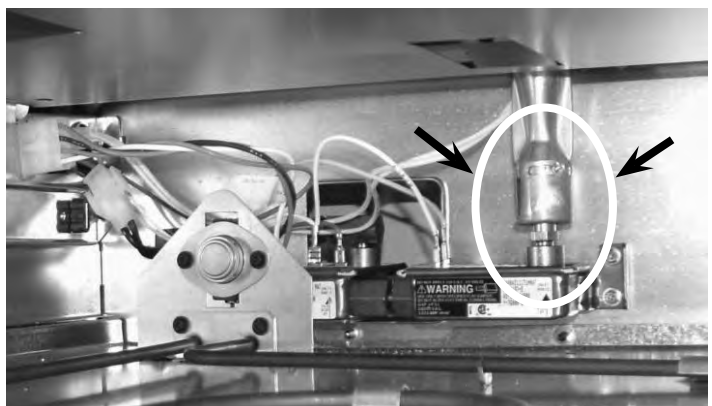
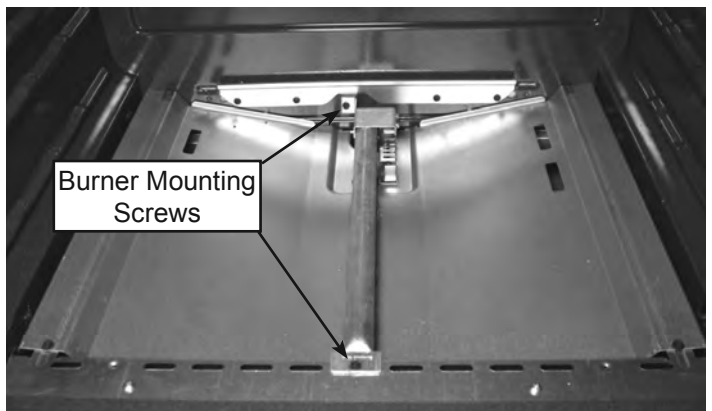
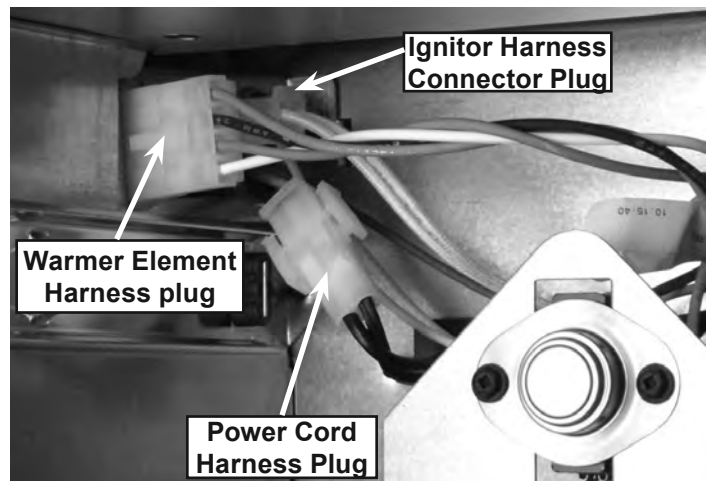

SERVICING OVEN BURNERS AND COMPONENTS

Servicing Broil Burner and Ignitor

The broil burner tube and baffle assembly is mounted to the top of the oven liner by five mounting screws.

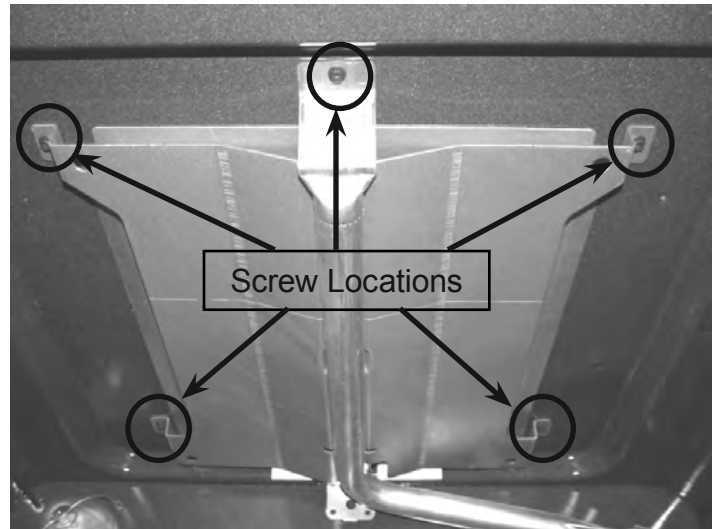

To remove the burner assembly remove the screws and slide the assembly to the left far enough to disengage the end of the burner tube from the orifice spud. The assembly can now be removed from the oven.

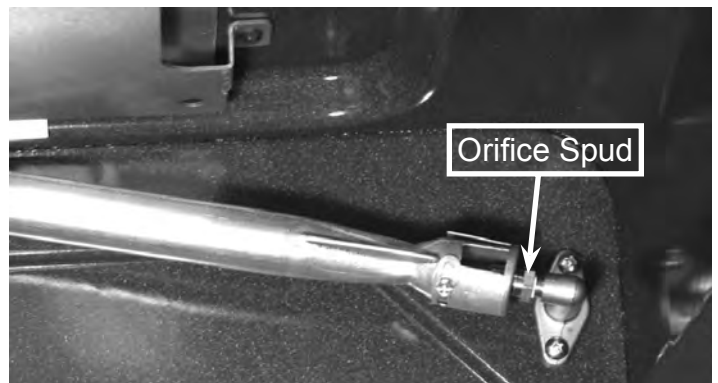

With the broil burner/baffle assembly removed the broil ignitor and ignitor cover are accessible. To remove the broil ignitor you must first disconnect the ignitor harness plug located behind the lower rear cover on the back of the range.

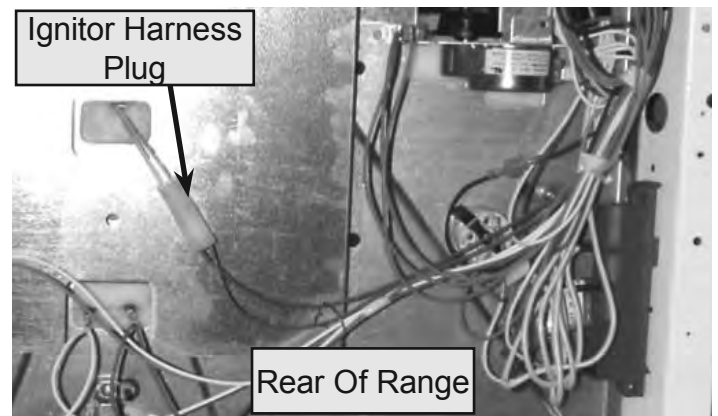

After disconnecting the ignitor harness plug remove the ignitor cover plate screw and remove the cover plate. Remove the two ignitor mounting screws and pull the ignitor harness through the cut out in the back of the oven liner.

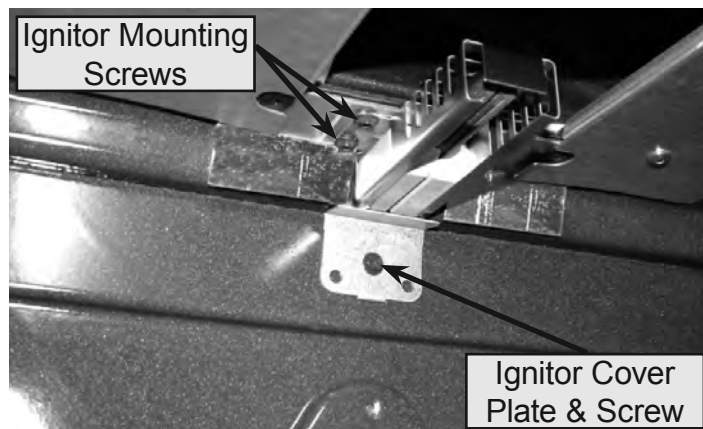

DIAGNOSING OVEN COMPONENT FAILURE

If the oven ignitor does not glow check for proper voltage to the ignitor. If the voltage is correct then the ignitor is defective. If the voltage is incorrect then the EOC relay may not be closing, the oven safety valve may be open, or the wiring connections may be faulty. If the oven ignitor glows but the oven burner fails to light then there are four main possible causes for failure.

Incorrect Voltage

Verify the incoming line voltage to the range. The minimum acceptable voltage is 108 VAC when tested under load. Proper polarity of the power supply must also be verified.

Gas Regulator Cut Off Lever

Check the lever on the regulator to be sure that it has not been turned off. This lever turns the gas off to the oven safety valve only. It does not affect the surface burners. Fig. 1 shows the regulator lever in the on position.

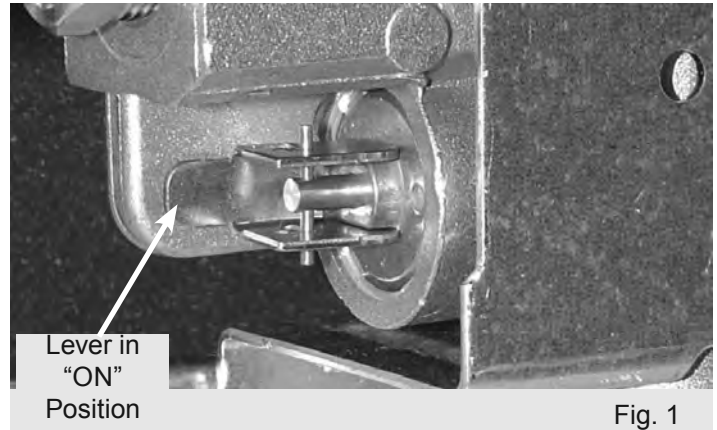

Faulty Oven Ignitor

In order to open the gas safety valve and allow gas to flow to the burner tube the ignitor must create a minimum 2.9 amp draw through the safety valve circuit.

Test the oven ignitor with an amp meter to determine if it is creating the proper amp draw. Do not assume that an ignitor is good simply because it is glowing brightly. Look at the examples in Fig. 2 & Fig. 3.

The ignitor in Fig. 2 is glowing brightly however the amp draw from this ignitor is only 2.79 amps and may not open the gas safety valve properly.

The ignitor in Fig. 3 is not significantly brighter than the one in Fig. 2 but the amp draw created (2.9 amps) should be sufficient to open the safety valve if the gas supply and pressure are correct.

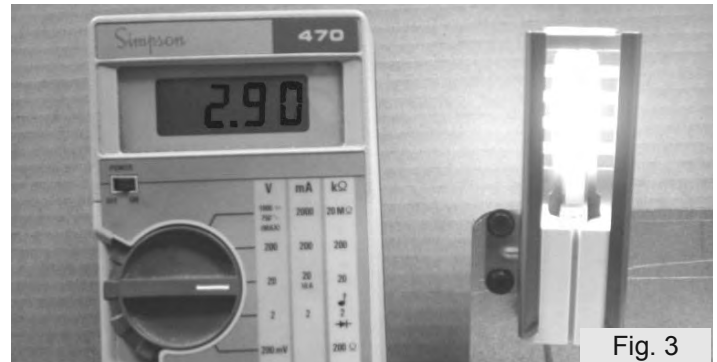
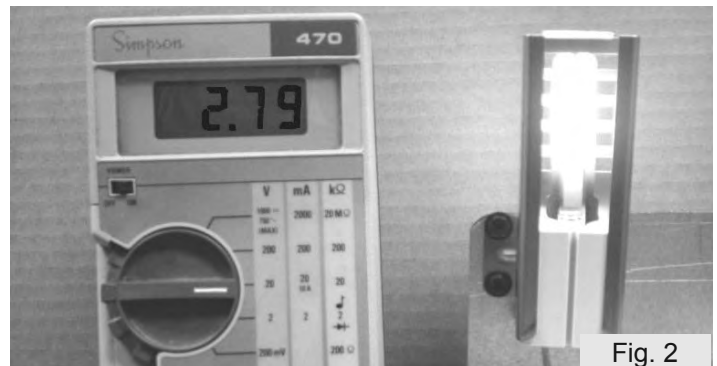

Faulty Gas Safety Valve

If the oven ignitor provides the proper amp draw through the safety valve circuit and the gas supply and pressure have been verified to be correct but the safety valve still will not open, then the fault is within the safety valve itself.

Fig. 4 shows a typical single burner gas safety valve and identifies the main parts.

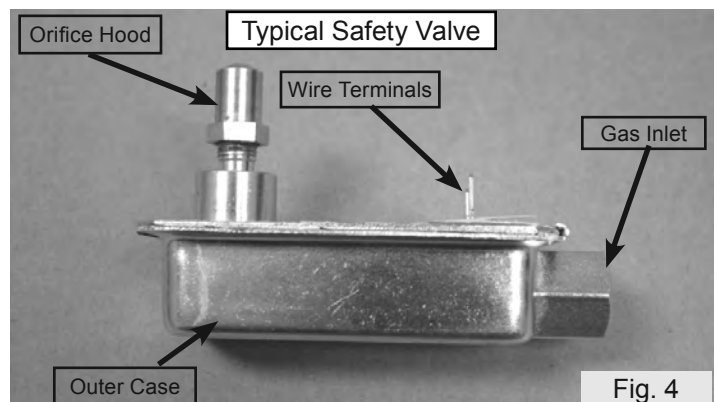

How The Safety Valve Works

Fig. 1 shows the safety valve with outer case removed and the valve in the closed position. Note that the rubber seal is pressed against the opening in the base that the orifice hood mounts onto. In this position the seal prevents gas from flowing out of the body of the valve and into the oven burner.

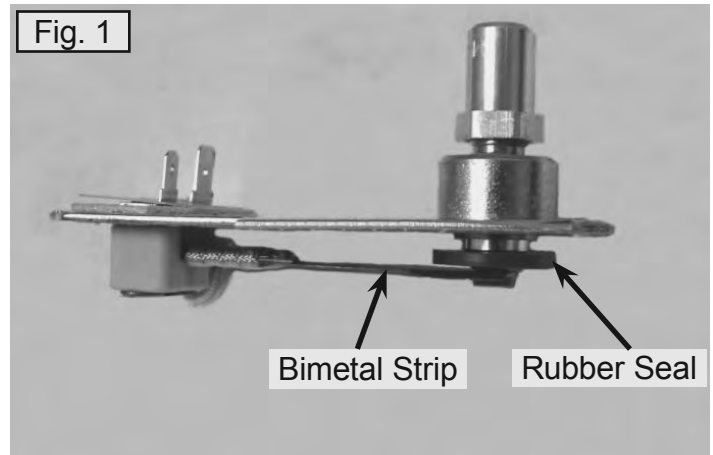

! NOTE !

NEVER APPLY LINE VOLTAGE TO THE OVEN SAFETY VALVE TERMINALS. THIS WILL RESULT IN BURNING OUT THE HEATER STRIP AND FAILURE OF THE VALVE. TEST THE CONTINUITY OF THE INTERNAL CIRCUIT WITH AN OHM METER.

When the oven control or thermostat is set to bake or broil, the relay or thermostat contacts close sending Line voltage to one wire of the ignitor. The neutral circuit is fed through the heater strip inside the safety valve to the other ignitor wire. See the strip circuit in Fig 2. for an example.

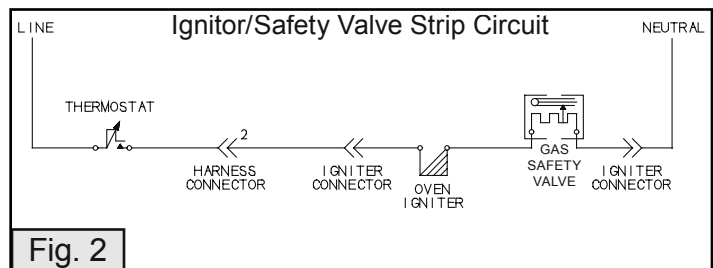
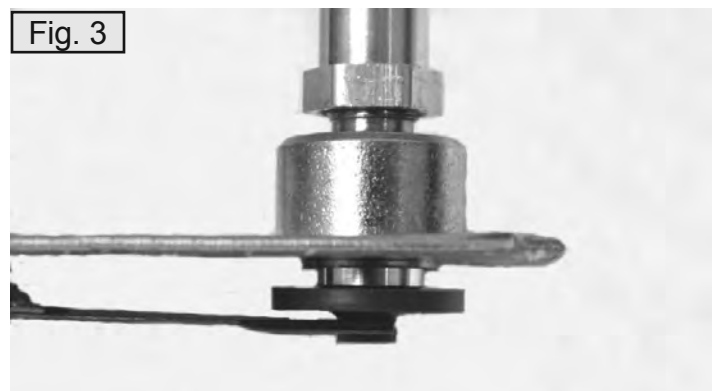
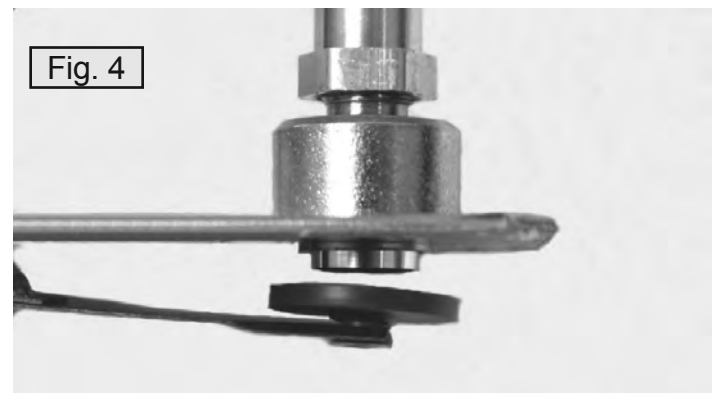

Fig. 3 shows the valve seal in the closed position. As the ignitor begins to heat the increased amp draw causes the heat strip to become hot and warp the bimetal strip. As the bimetal warps it pulls the rubber seal away from the hole in the base (Fig. 4). This allows gas to flow through the hole, through the orifice hood and into the oven burner tube. The valve will remain open as long as the ignitor maintains sufficient amp draw to keep the bimetal in the warped condition.



The safety valve can not be serviced or repaired. If found to be faulty it must be replaced. The heat strip circuit can be tested with an ohm meter by checking for approximately 1.4 ohms of resistance between the two wire terminals on the valve. Never apply direct line voltage to a safety valve. It must always be operated in series with the proper oven ignitor.



Safety Valve LP Gas Conversion

When the range is manufactured the orifices are set for use on Natural Gas. If the range is to be used with LP gas the orifice hoods for the bake and broil burner must be adjusted for proper gas flow.

Each orifice assembly has an LP metering pin located under the orifice hood. To adjust the hood for use on LP gas you simply turn the hood on the threaded base until the hood seals against the LP pin.

The following photographs and drawings illustrate how the gas flow is controlled when the Orifice Hood is set for Natural Gas and LP Gas.

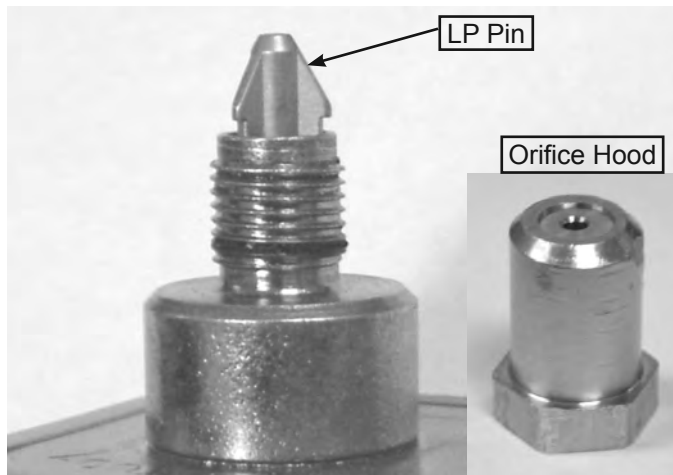

Orifice Base with Hood Removed

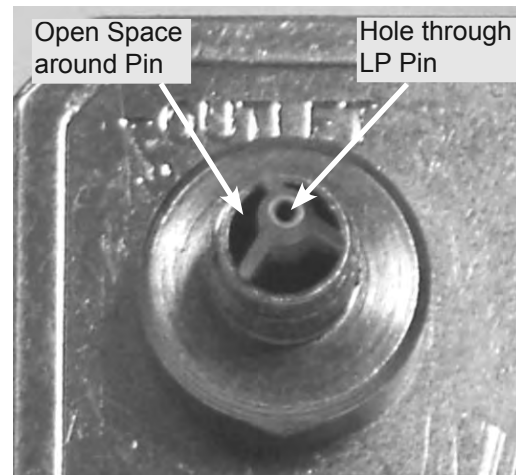

Top View of LP Pin and Base

When the orifice hood is set for natural gas operation, gas enters through the hole in the base of the orifice assembly and passes around the LP pin through the large spaces between the pin and base. Some gas also passes through the hole in the LP pin. The gas flows through the hole in the orifice hood which meters the gas flow rate for proper operation on Natural Gas. See the cutaway drawing D1.

When the orifice hood is screwed down against the LP pin it forms a seal preventing gas from bypassing the LP pin. Gas must flow through the smaller opening in the LP pin which meters the gas flow rate for proper LP operation. The LP pin functions as a stopper with a hole in it. See the cutaway drawing D2

For proper operation, the maximum inlet pressure to the regulator should be no more than 14 inches of water column pressure. The inlet pressure to the regulator must be at least 1 inch greater than regulator manifold pressure. Examples: If regulator is set for natural gas 4 inch manifold pressure, inlet pressure must be at least 5 inches; if regulator has been converted for LP/Propane gas 10 inch manifold pressure, inlet pressure must be at least 11 inches.

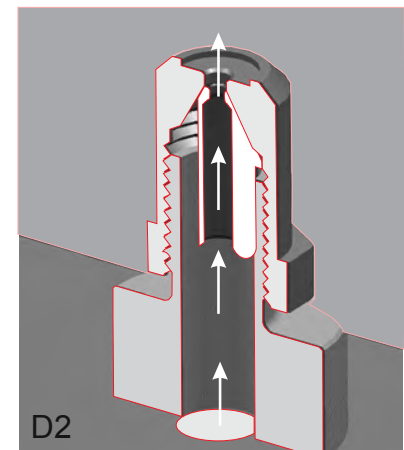
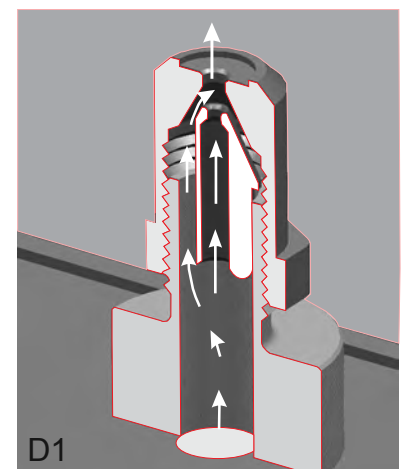

WARMER DRAWER

The purpose of the Warmer Drawer is to keep hot cooked foods at serving temperature. Always start with hot food. It is not recommended to heat cold food in the Warmer Drawer. All food placed in the Warmer Drawer should be covered with a lid or aluminum foil to maintain quality.

The operation of the warmer drawer element is controlled by a separate rotary switch on the control panel. The element cycles on and off at varying rates in relation to the selected setting causing the temperature to increase or decrease. The actual temperature can also be affected by environmental conditions such as room temperature, air currents, and customer use. **The warmer drawer temperature is not precisely controlled and variations from the operating temperatures listed below are normal.**

For best results, preheat the drawer before adding food. An empty drawer will preheat in approximately 15 minutes.

WARMER DRAWER TEMPERATURE TABLE			
SETTING	HI	MED	LO
*TEMP RANGE (°F)	180-200	160-180	140-160
* TEMPERATURES ARE APPROXIMATE			

Warmer Drawer Theory of Operation

The circuit diagram below shows a typical wiring and control setup for a warmer drawer on an electric or gas range. The warmer drawer is designed to operate on 120 VAC. The L1 wire on the warmer drawer switch is connected to L1 in the power supply harness and the L2 wire on the switch is connected to the neutral circuit in the harness. When the switch is turned on the contacts L1-H1 close connecting the L1 circuit to one side of the warmer drawer element. The contacts L2 - H2 also close completing the neutral circuit to the ½ wave diode which connects to the other side of the element. This circuit provides approximately 60 volts AC to the element resulting in lower wattage heat output from the element.

There is a parallel neutral circuit that provides neutral to the element through the Low Limit Thermostat. This circuit is always closed unless the temperature of the warmer drawer has reached the cut out point of the low limit thermostat. The purpose of this circuit is to allow the element to operate at full wattage and bring the drawer up to minimum operating temperature more rapidly. Once the low limit thermostat opens the circuit from H2 through the diode provides the neutral circuit to the element.

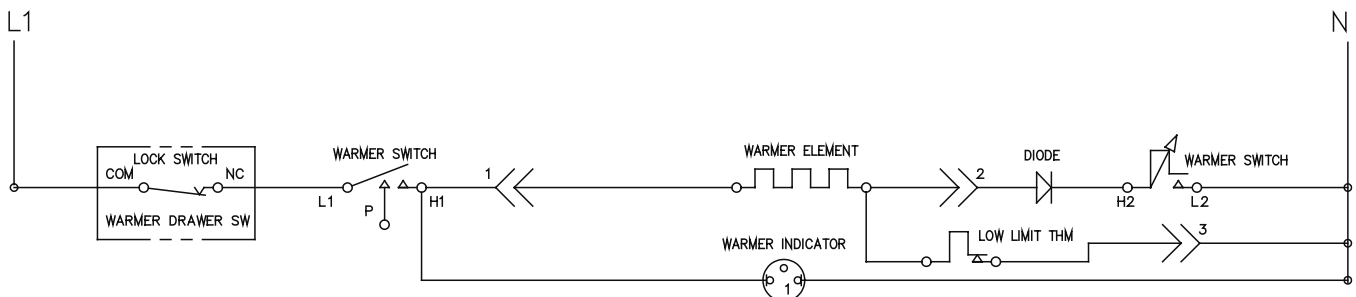

Troubleshooting Warmer Drawer Operation

The warmer drawer can fail in a variety of ways. If the element fails to heat at all you should test the switch contacts, element, low limit thermostat and all wiring connections and harness.

If the element heats only at low temperatures then the switch contacts L2-H2, diode, or wire harness or connections could be open.

If the warmer drawer overheats then the fault could be a shorted diode, low limit thermostat contacts stuck closed, element or wire harness shorted to ground. On a range that has just been installed it is also possible that there could be a miswired connection causing the overheat condition.

If it is determined that the diode is shorted then the warmer drawer wire harness must be replaced as an assembly.

SERVICING WARMER DRAWER COMPONENTS

!CAUTION!
ALWAYS DISCONNECT OR TURN OFF THE POWER SUPPLY TO RANGE
BEFORE REMOVING THE WARMER DRAWER

To service the warmer drawer body, drawer guides, or the element assembly first remove the warmer drawer per the instructions on page 7. With the warmer drawer removed the wire harness plug connector for the warmer element can be disconnected. Follow the instructions to reinstall the drawer after the repair or service is complete.

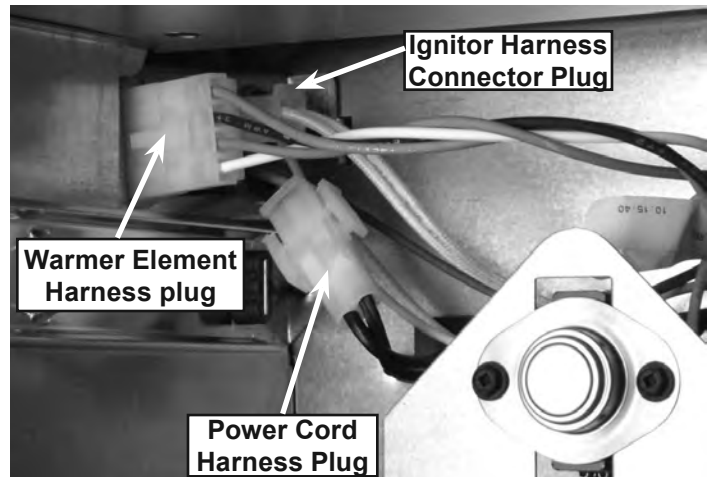

The warmer drawer element and thermostat are mounted to a metal base pan which must be removed in order to replace the element. To remove the base first go to the rear of the range and remove the screws that secure the warmer element base pan and the warmer drawer side shields to the main back panel.

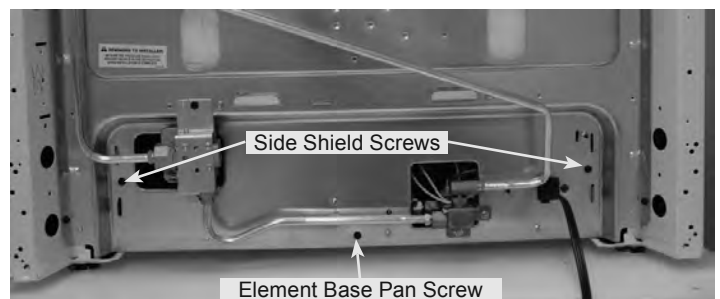

Remove the 1/4" hex screws that secure the drawer guide rail and element base pan on each side of the drawer opening.

Remove the drawer guide rail and drawer shield together by pulling straight forward.

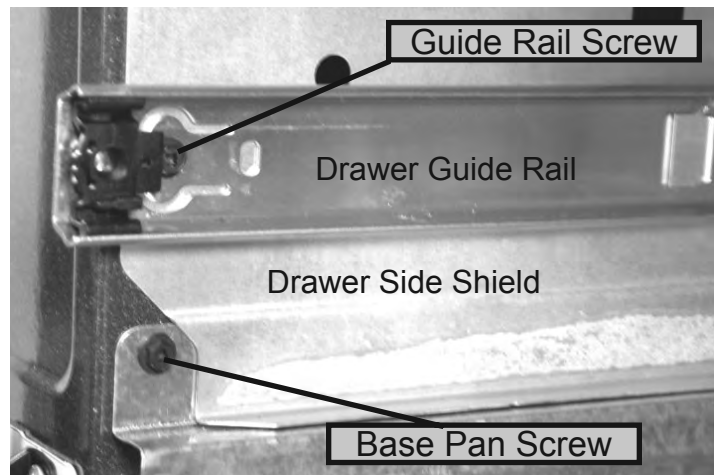

Once both of the drawer guide rails and side shields have been removed the base pan and element assembly can be pulled forward to remove from the range. See photo at right.

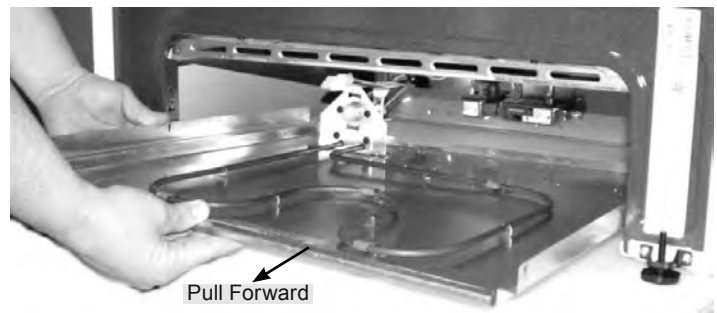

With the element and base pan assembly removed the element and thermostat are accessible for servicing. To dismount the element from the pan remove the screws and clips that secure it to the pan. Also remove the screw that secures the thermostat mounting bracket.

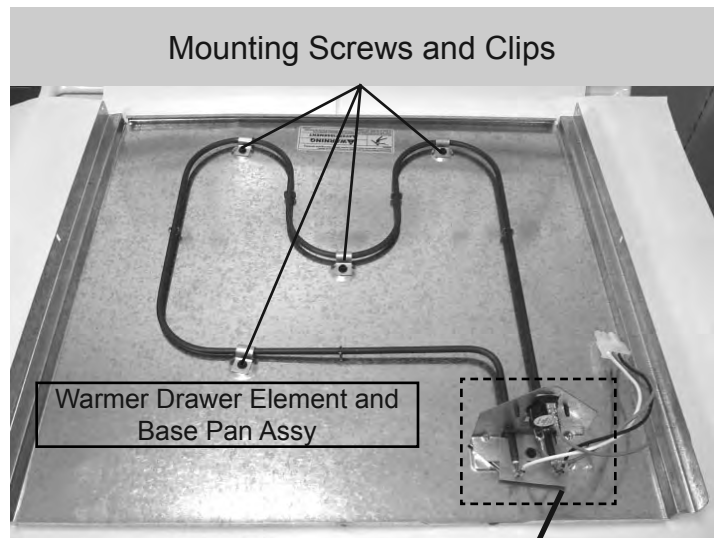

When reinstalling the thermostat mounting bracket always insure that the element terminal shield is installed and properly positioned.

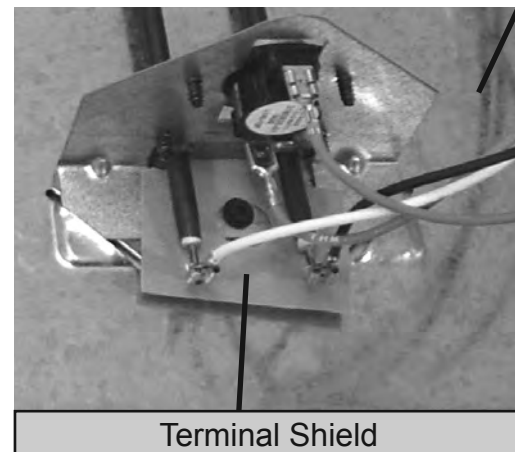

OVEN DOOR

The door construction has changed substantially. The door hinges had previously been mounted in the chassis. The new construction moves the hinges to the interior of the door.

To service or replace many of the components of the oven door it is often necessary to remove the door from the range. Below are instructions for removing and reinstalling the oven door. This information is also found in the owners guide.

To Remove Oven Door:

1. Fully open the oven door (horizontal with floor).
2. Pull the door hinge locks on both left and right door hinges down from the oven frame completely towards the oven door (See photo A). A tool such as a small flat-blade screwdriver may be required.
3. Close the door until it contacts the hinge locks.
4. Firmly grasp both sides of oven door along the door sides (Do not use the oven door handle).
5. Lift the oven door hinge arms over the roller pins located on each side of the oven frame (See Photo B).

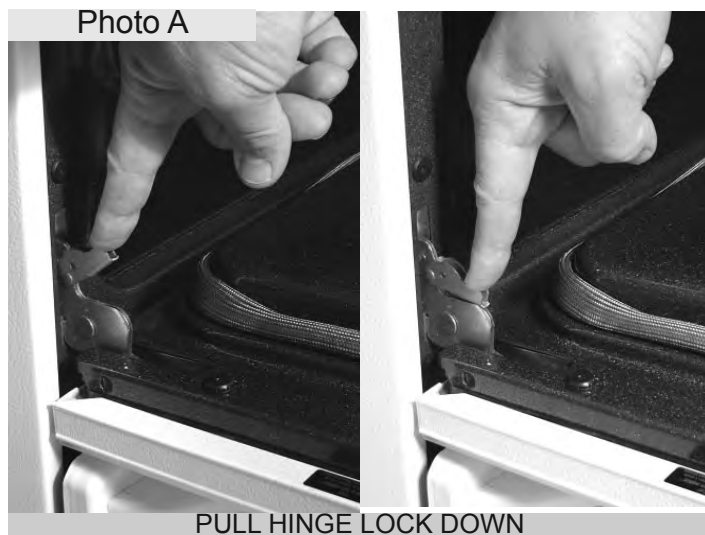

! CAUTION !

The door is heavy. For safe, temporary storage, lay the door flat with the inside of the door facing down.

To Reinstall Oven Door:

1. Firmly grasp both sides of oven door along the door sides (Do not use the oven door handle).
2. Holding the oven door at the same angle as the removal position, seat the hook of the hinge arm over the roller pins located on each side of the oven door frame.
3. Fully open the oven door (horizontal with floor).
4. Push the door hinge locks up towards and into the oven frame on both left and right oven door hinges to the locked position.
5. Close the oven door.

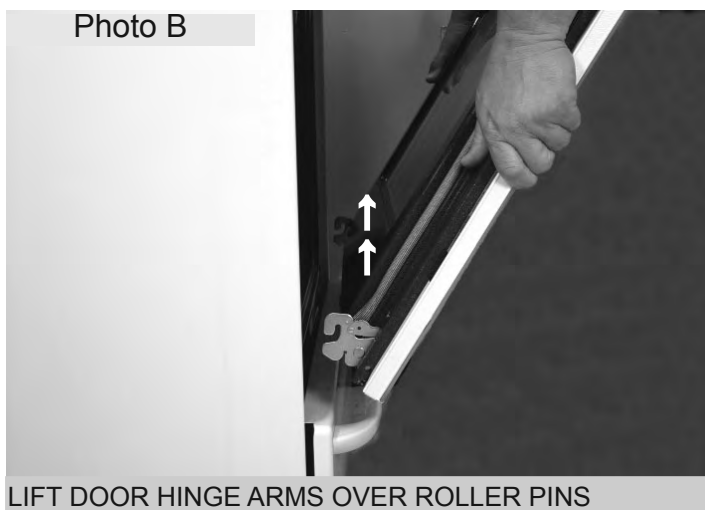

Door Hinge Replacement

Disassemble Door

1. Place the door with the handle side down on a protected work surface. The handle should hang off the edge of the bench or table.
2. Remove the bottom screws that secure the inner liner to the outer door panel. (Fig. 1)

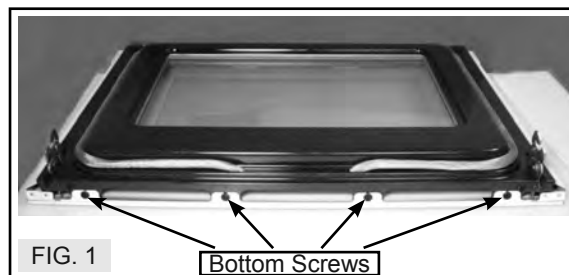

3. Remove the two handle mounting screws and remove the door handle. (Fig. 4)



4. Carefully separate the inner door panel and hinge assembly from the outer panel. Place the assembly with the hinge side hanging slightly off the work surface.

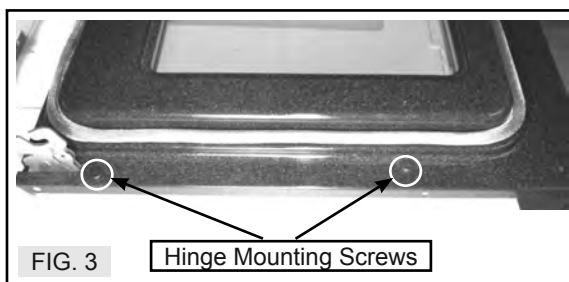

5. Remove the two hinge mounting screws and lower the hinge assembly away from the inner door panel. (Fig. 3 & Fig. 4).
6. Install new hinge and reverse the steps to reassemble the oven door.

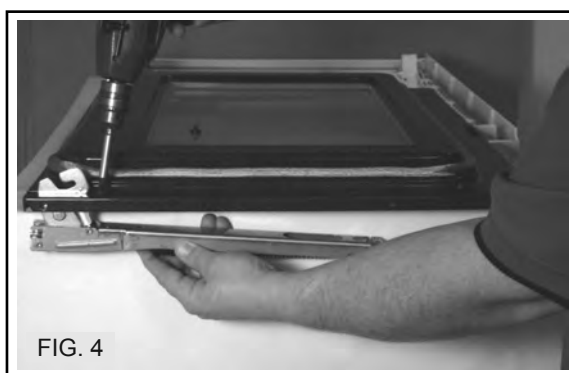

TIP: TO EASE INSTALLATION OF NEW HINGE, INSTALL AND REMOVE THE SELF TAPPING SCREWS INTO THE SCREW HOLES IN THE NEW HINGE . THIS WILL PRE-CUT THREADS INTO THE HINGE AND ALLOW FOR EASIER STARTING OF THE SCREWS ONCE THE HINGE IS IN POSITION.

When replacing the door hinges you must ensure that the hinge lock lever is in the fully engaged position in order to reinstall the oven door on the range. The hinge is replaced as a complete assembly only.

The same hinge assembly design is used for many different oven doors but with different door spring pull weights. The color of the door spring determines the pull weight. Make sure that the replacement hinge spring color is correct for the model that is being serviced.



Replacing Door Hinge Receptacle

The door hinges engage steel pins in the hinge receptacles which are mounted on the back side of the front chassis. The following instructions will explain the steps necessary for the various styles of ranges that you may encounter.

Begin by removing the oven door and warmer drawer or storage drawer as described in previous sections of this manual.

⚠ WARNING DISCONNECT OR TURN OFF ALL ELECTRICAL POWER AND GAS SUPPLY BEFORE SERVICING APPLIANCE

Remove warmer drawer side shields.
(Models With Warmer Drawer)

1. From the rear of the range remove the screws that secure the shields to the main back panel (Fig1).
2. From the front of range remove the screws that secure the drawer glide rail (Fig 2).

The drawer glide rail and drawer shield can be removed together by pulling straight forward.

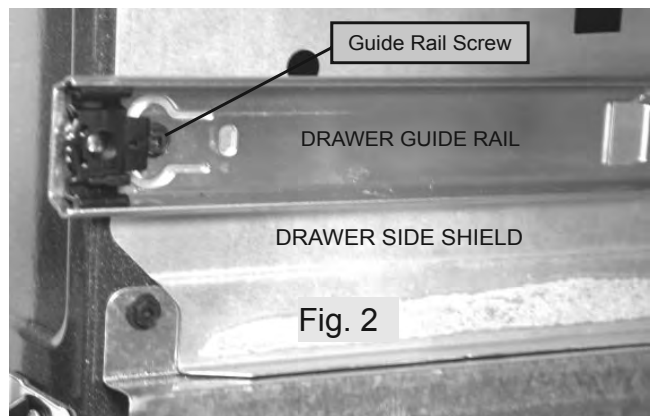
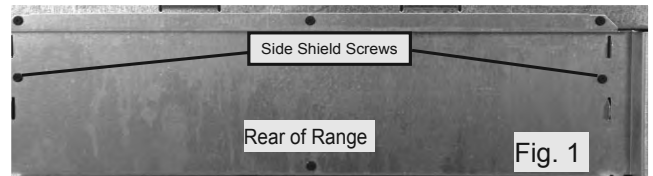

Remove hinge receptacle

1. Remove the two self tapping screws that secure the receptacle to the oven chassis frame (Fig 3). The receptacle may fall into the body-side leg channel but it can be easily retrieved.

USE CAUTION TO AVOID BEING CUT BY ANY EXPOSED SHARP EDGES.

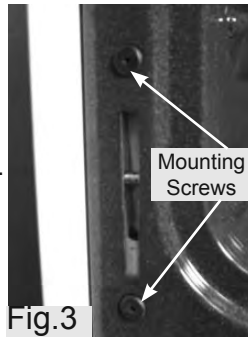

Install new receptacle

1. The new receptacle will have a black colored roller pin. Make sure to install the receptacle with the narrow end of the slot at the bottom (Fig. 4).

TIP: To ease installation of new receptacle, install and remove the self tapping screws into the screw holes in the new receptacle. This will pre-cut threads into the hinge and allow for easier starting of the screws once the hinge is in position.

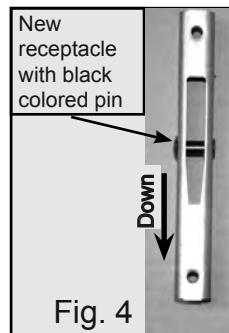

2. Carefully position the receptacle behind the front chassis and install the mounting screws (Fig. 5)
3. Reinstall warmer drawer side shields & glide rails, warmer drawer and oven door.

BODYSIDE MOUNTING

Changing the body side panel requires the removal of screws along the top and rear flanges and removing the two screws securing the front leg leveler to the chassis.

When replacing the body side panels depending on the model there may be two hidden fasteners that must be addressed. The first is a screw on the inside flange of the body side just behind the face of the chassis as shown in the photo to the right.

The second hidden fastener is located further down this same flange. The photo on the right shows a close up of the plastic retainer which is screwed to the side of the oven chassis. A square opening in the side panel hooks on the underside of the fastener.

Lower the body side panel to disengage the slot from the retainer.

NOTE: This second fastener will not appear on all models

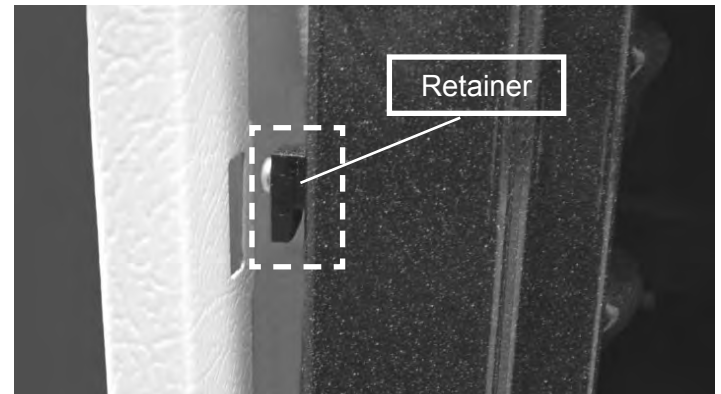
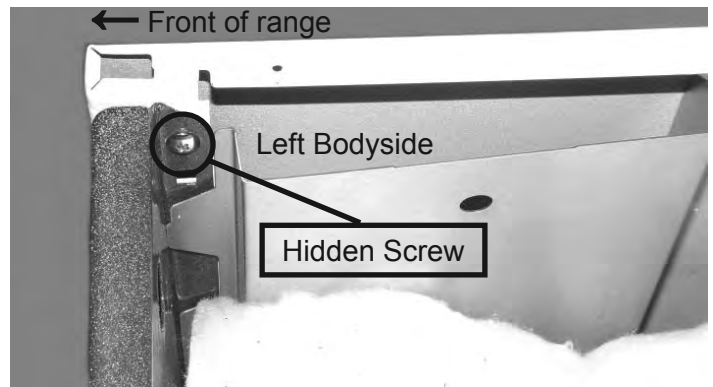

LEG LEVELERS

A newly designed, front mounted leg leveler has been added to provide for greater stability and easier access for adjustment. The new leveler is attached to the range two screws in the front that pass through the lower edge of the body side and into the oven chassis, and one screw from beneath that attaches to the body side panel.

NOTE: The front and rear leg levelers must be removed from the original bodyside panel and mounted on the new one before it is installed on the range.

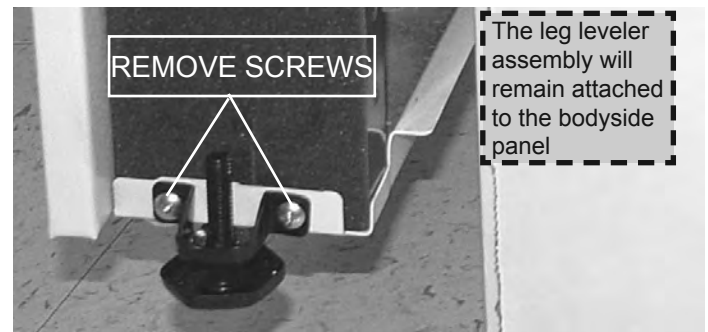

COMPONENT TESTING

Many of the range component circuits can be tested at the EOC wiring harness with an ohm meter. By following the wiring diagram and schematic diagram it is possible to perform continuity tests on the bake and broil ignitor circuits, lock motor windings, oven door switch and other component circuits. **When testing for continuity the power supply must be turned off or disconnected and the wire harness connector(s) for the circuit or component being tested must be unplugged from the EOC.** You must also ensure that the test probes of the meter are small enough to make contact with the wire terminal inside the harness plug.

By testing from the EOC harness plug the component part as well as the wire harness are tested at the same time. If the component circuit test fails at the EOC harness then a test of the component part itself is needed to verify that the component is faulty.

The wiring diagram below from model GLGF386D** shows all of the component circuits controlled by the EOC. By following the Component Test Point Matrix found on the next page most of the component circuits can be tested from the P5 harness connector.

By following the wiring diagram and schematic to determine which wires connect to the various components this technique can be applied to any model. The accompanying GAS RANGE COMPONENT RESISTANCE CHART provides the approximate resistance values of various components.

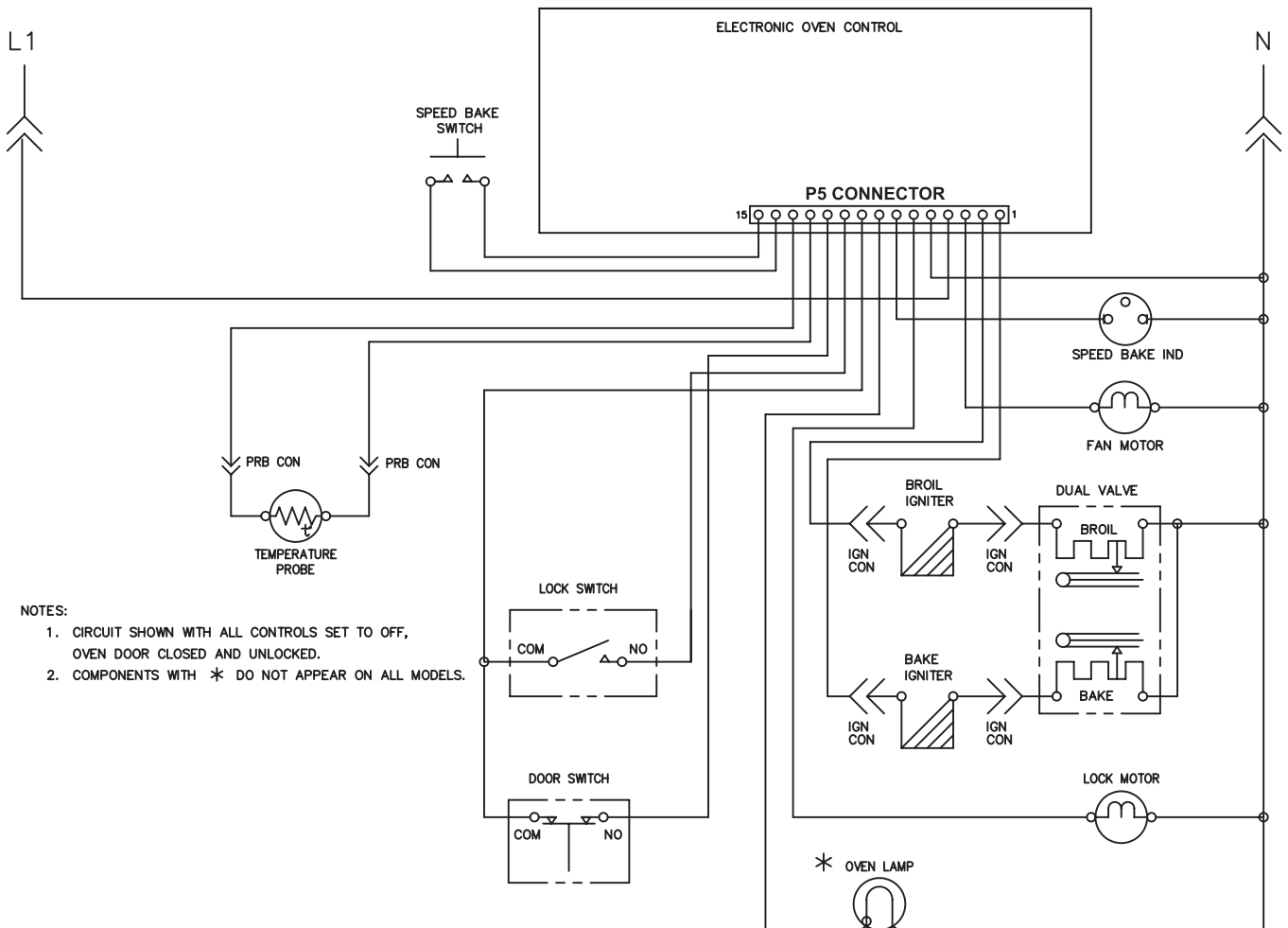

NOTES:

1. CIRCUIT SHOWN WITH ALL CONTROLS SET TO OFF, OVEN DOOR CLOSED AND UNLOCKED.
2. COMPONENTS WITH * DO NOT APPEAR ON ALL MODELS.

COMPONENT TEST POINT MATRIX
(GLGF386D**)

COMPONENT	P5 HARNESS TEST POINTS
BAKE IGNITOR/SAFETY VALVE CIRCUIT	#1 - #5 (Y - W)
BROIL IGNITOR/SAFETY VALVE CIRCUIT	#2 - #5 (BL - W)
SPEED BAKE FAN MOTOR	#3 - #5 (PR - W)
LATCH MOTOR WINDING	#6 - #5 (BR - W)
OVEN LAMP(S)*	#8 - #5 (T - W)
DOOR SWITCH	#9 - #11 (GY - P)
LOCK SWITCH (NORMALLY OPEN CIRCUIT)	#10 - #11 (O - P)
TEMPERATURE SENSOR PROBE	#12 - #13 (V - V)
SPEED BAKE SWITCH (MOMENTARY CONTACT)	#14 - #15 (BL - BL)
L1 POWER SUPPLY TO EOC	#4 (BK)

* Circuit will show continuity even if only one bulb is good. Check inoperative bulb(s) individually.

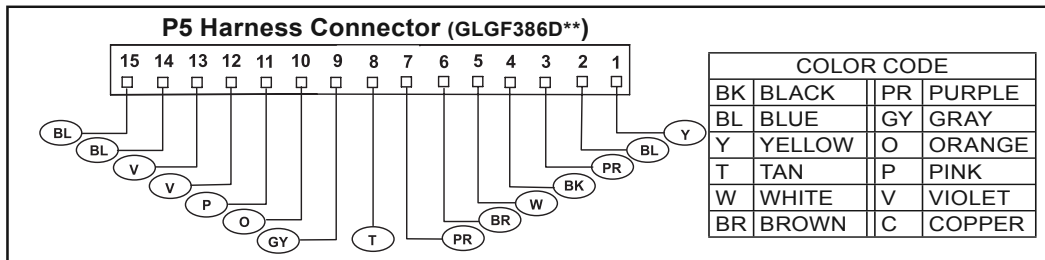

GAS RANGE COMPONENT RESISTANCE CHART

NOTE: RESISTANCE MEASUREMENTS ARE APPROXIMATE. VARIATIONS DUE TO TEMPERATURE CHANGES AND OTHER FACTORS ARE NORMAL.

COMPONENT	VOLTAGE RATING	WATTAGE	RESISTANCE Ω (OHMS)
WARMER DRAWER ELEMENT	108 / 232	700	20.5 Ω
WARMER DRAWER ELEMENT	108 / 232	450	32 Ω
CONVECTION ELEMENT	108 / 232	350	40 Ω
CONVECTION FAN MOTOR WINDINGS	108 / 232		15 Ω
LOCK MOTOR WINDINGS	108 / 232		2000 Ω
GAS SAFETY VALVE	**		1.5 Ω
BAKE IGNITOR	108 / 232		100 Ω
BROIL IGNITOR	108 / 232		80 Ω
OVEN TEMPERATURE SENSOR PROBE (AT ROOM TEMPERATURE)	-		1100 Ω * *(REFER TO RTD CHART)

** Never apply line voltage to the oven safety valve terminals.

ELECTRONIC OVEN CONTROLS

The newest generation of Electronic Oven Controls have significant improvements to make them easier for the consumer to operate and also provide enhanced diagnostic tools for the service technician. The most evident change is the expanded three digit Failure/Fault codes that will be displayed in the event of a malfunction. These new codes provide more detailed information than those displayed by previous EOC's. The Failure/Fault code chart found on page 9 lists the possible failure codes for current EOC's.

Below are examples of the current control configurations that can be found on freestanding gas self cleaning ranges. The controls for non self clean ranges have not changed.

ES 200 Control Features:

- Full slew up / down control
- Digital Time and Temperature Display
- Electronic Clock and Countdown Timer (12 Hour)
- Dual Radiant™ Baking (electric models)
- Variable broil (2 positions)
- Consumer selectable clean cycle (3 hour default - 2 hour optional)
- 12 hour energy saving shut-off with override for continuous operation
- Selectable F° or C° temperature readout
- Control Lockout (disables oven and locks door)
- User Adjustable Oven Temperature Offset



ES 300 Control Features:

- Automatic oven (Delay, Cook, and Off)
- Full slew up / down control
- Digital Time and Temperature Display
- Electronic Clock and Countdown Timer (12 Hour)
- Dual Radiant™ Baking (electric models)
- Variable broil (2 positions)
- Consumer selectable clean cycle (3 hour default - 2 hour optional)
- 12 hour energy saving shut-off with override for continuous operation
- Selectable F° or C° temperature readout
- Control Lockout (disables oven and locks door)
- User Adjustable Oven Temperature Offset



ES 330 Control Features:

- Automatic oven (Delay, Cook, and Off)
- Full slew up / down control
- Digital Time and Temperature Display
- Electronic Clock and Countdown Timer (12 Hour)
- Dual Radiant™ Baking (electric models)
- Variable broil (2 positions)
- Consumer selectable clean cycle (3 hour default - 2 hour optional)
- 12 hour energy saving shut-off with override for continuous operation
- Selectable F° or C° temperature readout
- Individual Keypad for Control Lockout (disables oven and locks door)
- Oven Light Switch in control.
- User Adjustable Oven Temperature Offset



ES 340 Control Features:

- Automatic oven (Delay, Cook, and Off)
- Full slew up / down control
- Digital Time and Temperature Display
- Electronic Clock and Countdown Timer (12 Hour)
- Dual Radiant™ Baking (electric models)
- Variable broil (2 positions)
- 2 Pre - programmed clean cycles (2 hour **Speed clean** - 3 hour **Clean**)
- 12 hour energy saving shut-off with override for continuous operation
- Selectable F° or C° temperature readout
- Control Lockout (disables oven and locks door)
- Oven Light Switch on control.
- User Adjustable Oven Temperature Offset





ES 510 Control Features:

- Convection Bake and Convection Roast settings
- Automatic Convection Conversion feature
- Sabbath Mode (Star-K Certified)
- Keep Warm Feature - Maintains 170°F oven temperature for up to 3 hours.
- Favorite Setting - User can program and store up to 3 different bake or timed bake cycles
- Automatic oven (Delay, Cook, and Off)
- Numeric Keypad Temperature Selection
- Digital Time and Temperature Display
- Electronic Clock and Countdown Timer (12 Hour)
- Dual Radiant™ Baking (electric models)
- Variable broil - Temperature adjustable between 400°F & 550°F
- 3 Pre - programmed clean cycles (2 hour **Speed clean** - 3 hour **Clean** - 4 hour **Maxx clean**)
- 12 hour energy saving shut-off with override for continuous operation
- Selectable F° or C° temperature readout
- Control Lockout (disables oven and locks door)
- Oven Light Switch on control.
- User Adjustable Oven Temperature Offset



Sales Demo Mode

A sales demo (SD) mode is available in the ES510 control that allows the control panel functions to be demonstrated without turning on any burners or elements. To enter or exit the SD mode disconnect power to the range. Reconnect the power and within 45 seconds touch the  keypad on the EOC and hold until “sd” appears in the EOC display (approximately 6 seconds). The ESEC display windows will also display “sd” momentarily and then go blank. The time of day display will blink until the clock is set. In the Sales Demo mode all control panel and display functions can be demonstrated but the elements will not heat.

To exit the Sales Demo mode you must repeat the procedure used to enter the Sales Demo mode. Disconnect the power to the range; reconnect the power and within 45 seconds touch and hold the  pad until the “sd” display disappears. You can not exit the Sales Demo mode by pressing the Stop/Clear keypad or by resetting the power to the range.

TROUBLESHOOTING ELECTRONIC OVEN CONTROLS

When an oven with an electronic control detects a failure condition, it usually signals the failure with an “F” code. These “F” codes are considered by many people to be an indicator as to positively which part in the circuit has failed (“F1” a defective control, “F3” a defective oven probe, and so on). To the embarrassment of many servicemen who have believed this, they have installed the indicated part only to find it did not correct the problem.

To troubleshoot an oven with an electronic oven control that is not operating:

1. Make sure electrical power is being supply to the control. Verify this by testing the voltage at the control wiring harness.
2. Disconnect power for 30 seconds. If fault returns when power is reconnected continue with the following steps.
3. Remove electrical power.
4. Go to the back of the control and disconnect the multi-pin plug.
5. Check the wiring diagram to determine which two pins in the plug (not on the EOC) are connected to the oven sensor.
6. With an Ohmmeter check the resistance between the two pins in the plug that are connected to the of sensor. At room temperature:

STEP 1

- If the meter reads below 900 Ohms or above 1200 Ohms, remove the sensor from the oven an check it for resistance. If the resistance of the sensor is the same as reading at the plug, the sensor is defective. Replace the sensor and test operation

STEP 2

- If the resistance of the sensor reads between 900 & 1200, the wiring between the control and the sensor is defective. Repair or replace wiring and test operation.

STEP 3

- If the meter reads between 900 Ohms & 1200 Ohms check the resistance between one of the pins going to the sensor and chassis. If the meter reads infinity go to step 4. If the meter shows continuity, remove the sensor and check from one of its pins to the case of the sensor. If the meter reads continuity, the sensor is defective. If the meter reads infinity, the wiring between the control and the sensor is shorted to chassis of the range.

STEP 4

- From the wiring diagram, determine which wires in the plug is from the door lock switch or switches. From the diagram determine which of the switches are open or closed when the door in the unlocked position. With an Ohmmeter check to see if the switch that is shown open is open and the switch that is shown closed is closed by checking the proper pins in the plug.

7. If the above checks test good and the relay on the board for the selected function is not closing replace the control.

IMPORTANT: If the oven problem is intermittent you must do the above test when the oven is malfunctioning.

EOC FAILURE / FAULT CODES

On freestanding gas and electric ranges manufactured beginning with the serial number date code **VF426** many of the EOC's will have expanded three digit fault codes. These codes may also appear in new replacement EOC's for ranges built prior to this date. Below is a list of possible fault codes that might appear in the EOC display window. The original two digit fault codes appear in the shaded boxes followed by the replacement three digit codes.

For each Fault code there is a listing of the likely failure condition or cause, as well as suggested corrective actions to be taken. Not all fault codes will appear in every model but the fault codes are universal and have the same meaning regardless of the model that is being serviced

Note: Fault codes are not a foolproof system. Never assume that a part has failed based on a displayed fault code. An example would be if the EOC is displaying F30 (open sensor), the failure could be caused by a loose connection or faulty wire harness between the EOC and sensor or the sensor could simply be unplugged.

FAULT CODE	LIKELY FAILURE CONDITION/CAUSE	SUGGESTED CORRECTIVE ACTION
F1	F10 Runaway Temperature. F11 Shorted Keypad. F12 Bad Micro Identification. F13 Bad EEPROM Identification/Checksum error. F14 Display tail missing/not connected	1. (F10 only) Check RTD Sensor Probe & replace if necessary. If oven is overheating, disconnect power. If oven continues to overheat when the power is reapplied, replace EOC. Severe overheating may require the entire oven to be replaced should damage be extensive. 2. (F11, 12 & 13) Disconnect power, wait 30 seconds and reapply power. If fault returns upon power-up, replace EOC. 3. (F14 only) Re-seat the P12 ribbon connector tail. If fault returns replace EOC (first action); Touch Panel (second action)
	F20 Communication failure between EOC and ESEC system. F26 Communication failure with mini oven control.	1. Test harness/connections P4 (EOC) & P11 (Surface element control board). 2. If harness checks O.K. failure can be caused by faulty UIB, surface element control board, or EOC. Check harness and connectors from the EOC to mini oven control board. Check for 15vdc to mini oven control (red & gray wires). If harness and voltage are good replace mini oven control. If fault returns replace EOC.
F3	F30 Open probe connection. F31 Shorted Probe connection	1. (F30 or F31) Check resistance at room temperature & compare to RTD Sensor resistance chart. If resistance does not match the RTD chart replace RTD Sensor Probe. Check Sensor wiring harness between EOC & Sensor Probe connector. 2. (F30 or F31) Check resistance at room temperature, if less than 500 ohms, replace RTD Sensor Probe. Check for shorted Sensor Probe harness between EOC & Probe connector.
	F40 Cooktop Lockout error. F41	1. (F40 or F41) Check the wiring. 2. (F40 or F41) Replace the Cooktop Lockout Control Board. 3. (F40 or F41) Replace EOC.
F9	F90 Maximum oven door unlock time exceeded. F91 Maximum oven door unlock attempts exceeded. F92 Maximum oven door open time exceeded. F93 Maximum oven door lock time exceeded. F94 Maximum oven door lock attempts exceeded.	1. (F90, 91, 92, 93 & 94) Check the wiring between EOC & Lock Motor Micro Switch. 2. (F90, 91, 92, 93 & 94) Replace the Motor Door Latch assembly if necessary. 3. (F90, 91, 92, 93 & 94) Check for binding of the Latch Cam, Lock Motor Rod & Lock Motor Cam. 4. (F90, 91, 92, 93 & 94) Check to see if Lock Motor Coil is open. If open, replace Lock Motor Assembly. 5. (F90, 91, 92, 93 & 94) Lock Motor continuously runs - if Micro Switch is open, replace Lock Motor Assembly. 6. (F92, 93 & 94) Check oven door Light Switch - if open, replace Switch. 7. If all situations above do not solve problem, replace EOC.

