

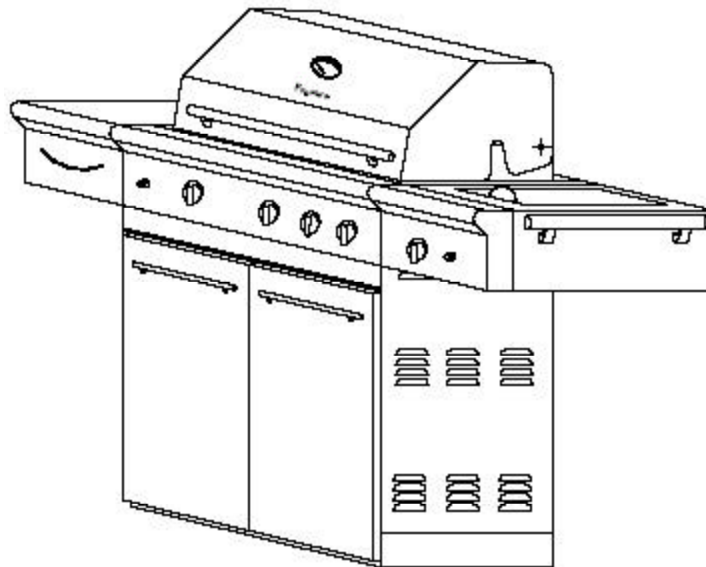

ELECTROLUX HOME PRODUCTS NORTH AMERICA

SERVICE MANUAL

Outdoor Gas Grill



Frigidaire

TAPPAN

W White-Westinghouse

Gibson

Kelvinator 

SAFE SERVICING PRACTICES - ALL APPLIANCES

To avoid personal injury and/or property damage, it is important that **Safe Servicing Practices** be observed. The following are some limited examples of safe practices:

1. **DO NOT** attempt a product repair if you have any doubts as to your ability to complete it in a safe and satisfactory manner.
2. Before servicing or moving an appliance:
 - Remove the power cord from the electrical outlet, trip the circuit breaker to the OFF position, or remove the fuse.
 - Turn off the gas supply.
3. Never interfere with the proper operation of any safety device.
4. **USE ONLY REPLACEMENT PARTS CATALOGED FOR THIS APPLIANCE. SUBSTITUTIONS MAY DEFEAT COMPLIANCE WITH SAFETY STANDARDS SET FOR HOME APPLIANCES.**
5. **GROUNDING:** The standard color coding for safety ground wires is **GREEN**, or **GREEN** with **YELLOW STRIPES**. Ground leads are not to be used as current carrying conductors. It is **EXTREMELY** important that the service technician reestablish all safety grounds prior to completion of service. Failure to do so will create a hazard.
6. Prior to returning the product to service, ensure that:
 - All electrical connections are correct and secure
 - All electrical leads are properly dressed and secured away from sharp edges, high-temperature components, and moving parts
 - All non-insulated electrical terminals, connectors, heaters, etc. are adequately spaced away from all metal parts and panels
 - All safety grounds (both internal and external) are correctly and securely connected
 - All panels are properly and securely reassembled

ATTENTION!!!

This service manual is intended for use by persons having electrical and mechanical training and a level of knowledge of these subjects generally considered acceptable in the appliance repair trade. Electrolux Home Products cannot be responsible, nor assume any liability, for injury or damage of any kind arising from the use of this manual.

SAFE SERVICING PRACTICES	2
GENERAL SAFETY INSTRUCTIONS	7
Important safety information	7
For your safety	7
QUICK REFERENCE SHEET	8
Owner guide and parts information	8
Serial nameplate location	8
Refer to the serial name plate for	8
Gas pressure	9
BTUs per pound of propane	9
Electrical power for igniter system	9
IGNITER WIRING SCHEMATICS	9
Side and Bottom Infrared burners	9
Grills with three igniters	10
Grills with four igniters	10
SECTION A - GENERAL INFORMATION	11
Gas requirements	11
Installation of natural gas regulator	12
L.P. Gas installation	13
L.P. Tank information	13
L.P. Tank use	13
LP Gas hook-up	14
Leak testing	14
SECTION B - GAS SUPPLY	15
SECTION C - IGNITION SYSTEM	16
Battery power models	16
Problems that can occur in the system	17
SECTION D - TROUBLESHOOTING FLOW CHARTS	19
Grill completely inoperative (Grill connected to natural or large L.P. tank)	20
Grill completely inoperative (Grill connected to 20 lb L.P. tank)	21
Igniters do not spark	22
Some of the burners will not operate	23
All burner flames yellow and way to large	23
All burner flames small (about 1/4 inch)	24
Burner flame is mostly yellow or orange,possibly in conjunction with smell of gas	25
Ceramic burner pops and flutters	26
Igniter sparks tip to chassis not tip to tip	26
Grill hotter in back than in front	26
SECTION E - TEARDOWN (MODELS WITH SERIAL NUMBER STARTING WITH THE LETTER "L")	27
Removing the temperature gauge	27
Removing the roll top grill hood handle end caps	27
Removing the roll top grill hood handle	27
Removing the roll top grill hood	28
Removing the battery	29
Removing the battery housing (GL models)	29
Removing the battery housing (FD models)	29
Removing the burner spark module	30
Removing the left shelf (GL models)	30
Removing the left shelf (FD models)	30
Removing the back infrared burner knob	31
Removing the back infrared burner knob bezel	31
Removing a main burner knob	31

Removing a main burner knob bezel _____	31
Removing the heat shield above back infrared burner _____	31
Removing the back infrared burner cover _____	32
Removing the back infrared burner igniter shield _____	32
Removing the back infrared burner igniter _____	32
Removing the back infrared burner _____	33
Removing the back infrared burner spud _____	33
Removing the back infrared burner orifice assembly _____	33
Removing the side burner grate _____	34
Removing the side burner cap (GL models) _____	34
Removing the side burner head (GL models) _____	34
Removing the side burner (FD models) _____	35
Removing the side burner orifice (GL models) _____	35
Removing the side burner orifice (FD models) _____	35
Removing the side burner orifice holder and tube (GL models) _____	35
Removing the side burner igniter (GL models) _____	36
Removing the side burner igniter (FD models) _____	36
Removing the side burner base (GL models) _____	36
Removing the side burner valve (GL models) _____	37
Removing the side burner valve (FD models) _____	37
Removing the side burner shelf (GL models) _____	37
Removing the side burner shelf (FD models) _____	38
Removing the regulator and hose assembly (Models built before October 2004) _____	38
Removing the regulator and hose assembly (Models built after September 2004) _____	38
Removing the warming shelf _____	39
Removing the main grates _____	39
Removing the top flavor grids _____	39
Removing the bottom flavor grids _____	39
Removing the backsplash (44" and 51" models) _____	40
Removing the backsplash (38" and smaller models) _____	40
Removing the (3) burner crossover shield _____	41
Removing the (2) burner crossover shield _____	41
Removing the main burner igniters _____	41
Removing the main burners (44" and 51" models) _____	41
Removing the main burners (38" and smaller models) _____	41
Replacing the igniter high voltage wire _____	42
Removing the bottom infrared burner igniter shield _____	42
Removing the bottom infrared burner igniter _____	43
Removing the bottom infrared burner _____	43
Removing the bottom infrared burner rear mounting bracket _____	43
Removing the bottom infrared burner front mounting bracket _____	44
Removing the bottom infrared burner valve orifice _____	44
Removing the bottom infrared burner valve orifice extension _____	44
Removing the bottom infrared burner valve orifice elbow _____	45
Removing the bottom flavor grids rear bracket (44" and 51" models) _____	45
Removing the front upper heat shield (44" and 51" models) _____	45
Removing the a main burner orifice (44" and 51" models) _____	46
Removing the a main burner orifice (38" and smaller models) _____	46
Removing the gas tube from the infrared burner valve _____	46
Removing the lower front heat shield (44" and 51" models) _____	46
Removing the manifold (Models built after September 2004) _____	47
Removing the manifold (Models built before October 2004) _____	48
Removing the main burner valves _____	48
Removing the bottom heat shield (44" and 51" models) _____	49
Removing the bottom rear heat shield (38" and smaller models) _____	49
Removing the bottom side heat shields (38" and smaller models) _____	50
Removing the back heat shield (44" and 51" models) _____	50

Removing the side heat shields (44" and 51" models)	51
Removing the front side heat shields (38" and smaller models)	51
Removing the gas line between base and manifold (38" and smaller models)	51
Removing the drip pans (44" and 51" models)	52
Removing the drip pans (38" and smaller models)	52
Removing the drip pan handle and faceplate (44" and 51" models)	52
Removing the warming drawer: (44" and 51" models)	52
Removing the warming drawer handle and front plate (44" and 51" models)	53
Removing the cart door	53
Removing the cart door handle (44" and 51" models)	53
Removing the cart door handle end caps and handle (38" and smaller models)	53
Removing the cart door magnetic latch	54
Removing the LP tank tray assembly (44" and 51" models)	54
Removing the LP tank tray assembly glides (44" and 51" models)	54
Removing the cart drawer assemblies (44" and 51" models)	54
Removing the cart drawer assembly handle: (44" and 51" models)	55
Removing the grill from the cart (38" and smaller models)	55
Removing the grill from the cart (44" and 51" models)	56
Removing the wheel channels (38" and smaller models)	57
Removing the wheel channels (44" and 51" models)	57
Removing the cart's rear panel: (38" and smaller models)	57
Removing the cart's side panels: (38" and smaller models)	58
Removing the drawer housing top (44" and 51" models)	58
Removing the drawer housing sides (44" and 51" models)	58
Removing the cart's rear panel (44" and 51" models)	59
Removing the cart's front center panel (44" and 51" models)	59
Removing the cart's side panels (44" and 51" models)	60
Removing the cart's front brace (44" and 51" models)	61

SECTION F - TEARDOWN MODELS WITH SERIAL NUMBER

STARTING WITH THE LETTER "D"	62
Removing the temperature gauge	62
Removing the roll top grill hood handle assembly	62
Removing the roll top grill hood handle post from the handle	62
Removing the roll top grill hood	63
Removing the side drawer	63
Removing the side drawer handle	64
Removing the side drawer shelf	64
Removing the knobs	64
Removing knob bezel	64
Removing the batteries for the main burners and side burner	65
Removing the infrared burner and igniter shield	65
Removing the infrared burner rear heat shield	65
Removing the infrared burner spud	65
Removing the infrared burner orifice assembly	66
Removing the back infrared burner	66
Removing the side burner cover	67
Removing the side burner grate	67
Removing the side burner head	67
Removing the side burner ring	67
Removing the side burner body	68
Removing the side burner orifice	68
Removing the side burner orifice base	68
Removing the side burner control panel	68
Removing the side burner igniter	69
Removing the side burner igniter module battery holder combination	69
Removing the side burner valve	69
Removing the side burner manifold	70

Removing the side burner push bar	70
Removing the side burner assembly	70
Removing the main grates	70
Removing the top flavor grids	70
Removing the bottom flavor grids	71
Removing the main control panel	71
Removing the main combination battery holder and spark module combination	71
Removing the main burners	71
Removing the main valves and manifold pipe assembly	72
Removing the main burner orifices	72
Removing the main burner valves	72
Removing the burner box	73
Removing the infrared burner igniter	74
Removing the main burner igniters	74
Removing the small manifold that spilt the incoming gas	74
Removing the grease tray	75
Removing the grill from the cart	75
Removing the towel rack	75
Removing the door handle	75
Removing the cylinder holder	76
Removing the cylinder holder locking bolt	76
Removing the cylinder holder side tracks	76
Removing the cylinder holder side rails	76
Removing the doors	76
Removing the door hinges	77
Removing the door magnet	77
Removing the cart's front frame	77
Removing the side panels	78
Removing the rear panel	78
Removing the casters	79
Removing the weights	79

General Safety Instructions:



IMPORTANT SAFETY INFORMATION

- Read this manual carefully before using your grill to reduce the risk of fire, burn hazard or other injury.
- Extreme care should be used because of the high temperatures produced by this appliance. **CHILDREN SHOULD NOT BE LEFT UNATTENDED IN AN AREA WHERE THE GRILL IS BEING OPERATED.**
- This appliance must be kept clear from combustible materials, gasoline or other flammable vapors and liquids. Do not allow flammable materials to come in contact with grate, burner or hot surfaces.
- Use only outdoors and provide good ventilation to avoid carbon monoxide build-up which could result in injury or death.
- Do not repair or replace any part of this appliance unless it is specifically recommended in this manual. A qualified service technician should conduct all other service.
- Follow the installation and servicing instructions provided with this product. Have your grill installed by a qualified service technician.
- Locate the main gas supply valve so that you know how to shut the gas off to your grill.
- If you smell gas, make sure all gas connections are tight before operation. If you continue to smell gas call a qualified technician.
- When lighting a burner, always pay close attention to what you are doing and be certain you are pushing the igniter that lights the burner you intend on using.
- Always keep your face and body as far away as from the grill as possible when lighting to reduce the risk of burn.
- Extinguish all flames and do not smoke while engaging gas and igniting the grill.

FOR YOUR SAFETY

If you smell gas:

1. Shut off gas to the appliance.
2. Extinguish any open flames.
3. Open grill hood.
4. If odor continues, immediately call your gas supplier or your fire department.

FOR YOUR SAFETY

DO NOT store or use gasoline or other flammable vapors and liquids in the vicinity of this or any other appliance.

An LP cylinder not connected for use shall not be stored in the vicinity of this or any other appliance.

CALIFORNIA PROPOSITION 65 - WARNING:

The Burning of gas cooking fuels generates some by products which are on the list of substances which are known by the State of California to cause cancer or reproductive harm. California law requires businesses to warn customers of potential exposure to such substances. To minimize exposure to these substances, always operate this unit according to the use and care manual, provide good ventilation when cooking with gas.

THIS APPLIANCE IS FOR OUTDOOR USE ONLY.

This appliance is not intended to be installed in or on recreational vehicles or boats.

THIS APPLIANCE HAS BEEN TESTED IN ACCORDANCE WITH ANSIZ21.58b-2002/CGA 1.6b-M02 STANDARD FOR OUTDOOR COOKING GAS APPLIANCES. THIS GRILL IS FOR OUTDOOR USE ONLY.

Check your local building codes for the proper method of installation. In the absence of local codes, this unit should be installed in accordance with the National Fuel Gas Code No. Z223.1-2002 and the National Electrical Code ANSI/NFPA No. 70-1990

WARNING

DO NOT try lighting this appliance without reading the “**LIGHTING INSTRUCTIONS**” section of this manual.

QUICK REFERENCE SHEET

1. Owner guide and parts information may be view or downloaded at:

www.frigidaire.com

2. Serial nameplate location:

Models with serial number that start with the letter "L"



Inner liner of cabinet door.

Models with serial number that start with the letter "D"



Back of grill

3. Refer to the serial name plate for:

Gas type.

Grill input rate.

Burner ratings

Gas Type: NG LP

UNIT	E44	E51	E57
Grill Input Rate	65,000 BTU/HR	65,000 BTU/HR	65,000 BTU/HR
Rotis Input Rate	15,000 BTU/HR	18,000 BTU/HR	18,000 BTU/HR
Side Burner Input Rate	17,000 BTU/HR	17,000 BTU/HR	34,000 BTU/HR
Bottom (infrared) Rate		20,000 BTU/HR	20,000 BTU/HR

4. Gas pressure:

Pressure regulator specifications natural gas. Input - 5 to 14 inches of water column.
Output - 4 inches of water column.

Pressure regulator specifications LP gas. Input - 5 to 14 inches of water column.
Output - 11 inches of water column.

5. BTUs per pound of propane:

One pound of propane will product about 22,000 BTUs.

6. Electrical power for igniter system:

One 1.5 volt AA battery for each module
Model with serial number that start with the letter "D" the side burner module uses one AAA battery.

IGNITER WIRING SCHEMATICS:

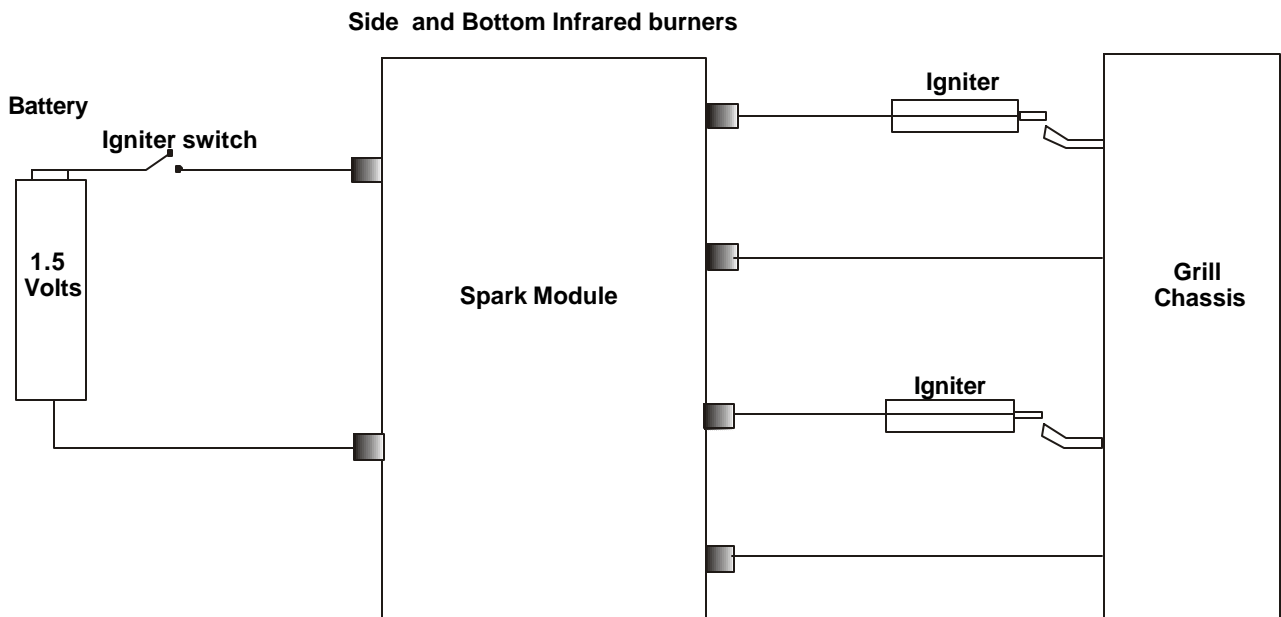

Grills with three igniters

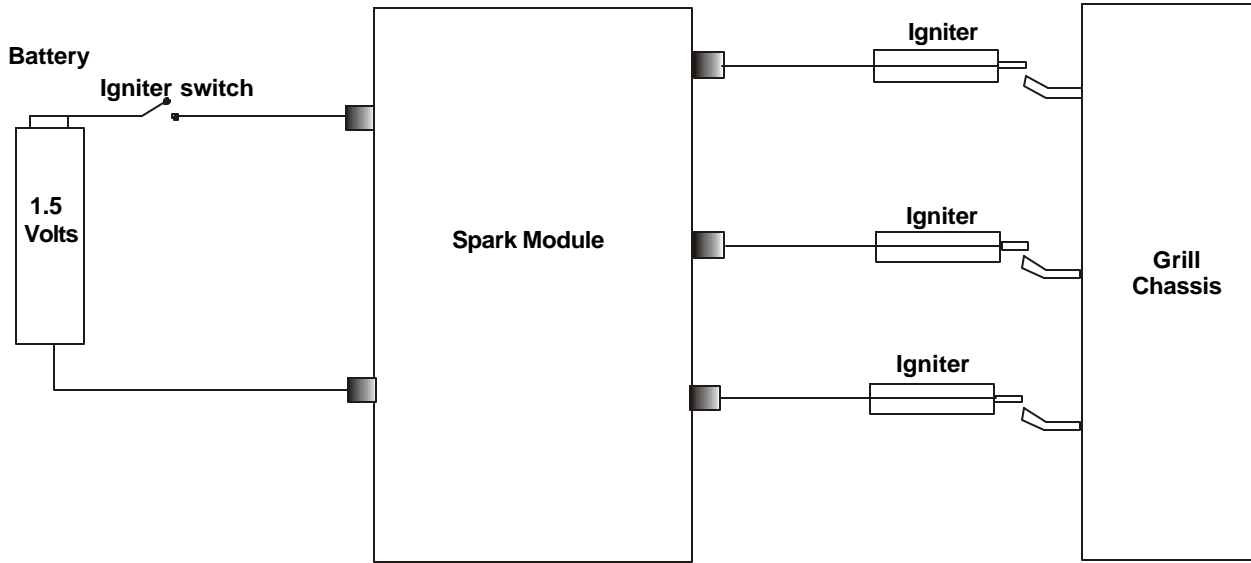

Grills with four igniters

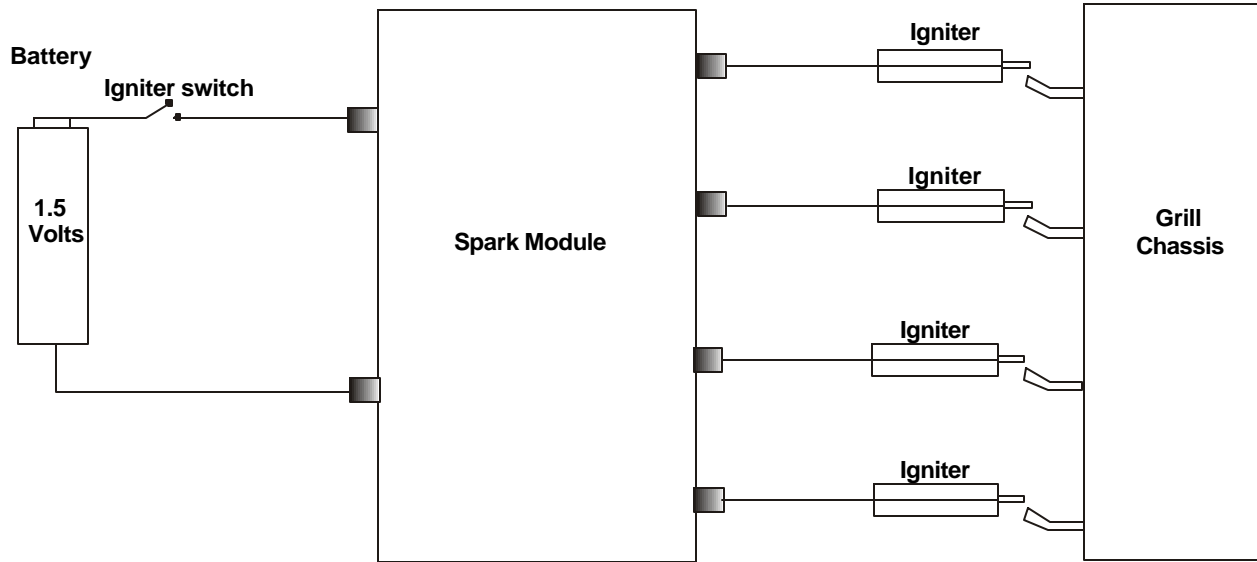

SECTION A - GENERAL INFORMATION

GAS REQUIREMENTS

⚠ WARNING Never attach an unregulated gas line to the appliance. Connection to an unregulated gas line can cause excessive heat or fire.

Verify the type of gas supply to be used, either Natural Gas (N.G.) or Liquid Propane (L.P.), and make sure the serial plate agrees with that of the supply. Conversion kits are available separately for an additional cost which will enable you to convert your grill from L.P. to N.G. or to convert your grill from N.G. to L.P. Please see your local dealer for more information.

NOTE: Always have a qualified service technician perform difficult conversions or modifications.

For natural gas installations, an installer must supply a gas shutoff valve that is easily accessible to the grill. All installer supplied parts must conform to local codes, or in the absence of local codes, with the National Electrical Code, ANSI/NFPA 70-1990, and the National Fuel Gas Code, ANSI Z223.1-1998.

All pipe sealants must be an approved type and resistant to the actions of L.P. gases. Never use pipe sealant on flare fittings. All gas connections should be made by a competent qualified service technician and in accordance with local codes and ordinances. In the absence of local codes, the installation must comply with the National Fuel Gas Code, ANSIZ223.1-1998.

This grill and its individual shut off valve must be disconnected from the gas supply piping system during any pressure testing of that system at test pressures in excess of 1/2 PSIG (3.5 kPa.).

This grill must be isolated from the gas supply piping system by closing its individual manual shut-off valve during any pressure testing of the gas supply piping system at test pressures equal to or less than 1/2 PSIG (3.5 kPa.).

The installation of this grill must conform with local codes, or in the absence of local codes, with National Fuel Code, ANSIZ223.1a-1998.

Installation in Canada must be in accordance with the Standard Can1-b149.1 and or .2 (installation code for gas burning appliances and equipment) and local codes.

NATURAL GAS INSTALLATION

The gas inlet supply pressure should be between 5" and 14" water column,(w.c.) A step down regulator is required if the line pressure is in excess of 14" w.c. Inlet pressure must not exceed 14" water column (1/2 PSIG).

Check your local gas utility company or with local codes for instructions on installing gas supply lines. Be sure to check on type and size of run, and how deep to bury the line. If the gas supply line is too small, the grill will not operate correctly.

Any joint sealant used must be an approved type and be resistant to chemical breakdown resulting from the reaction with N.G.

Attach the natural gas regulator (supplied with your grill) to the brass fitting coming out the bottom, right side of the grill (be sure the arrow on the regulator is pointing up towards the grill). Attach your gas line to the 3/8" flare fitting coming out of the natural gas regulator under the grill.

NOTE: The gas line connection and the gas fitting must be the same diameter.

Installer supplied shut-off valve (not included) - Place the shut-off valve in an accessible location to enable the gas supply to be cutoff to the unit.

NOTE: A flexible natural gas line is not included with Frigidaire grills. Natural gas flex line must be purchased separately based on the distance of your grill location from the natural gas line. Please be sure to check the size of your home's natural gas line fitting to make sure you get the right size connection for your particular application.

If you have questions, please consult your local natural gas distributor or qualified service technician.

INSTALLATION OF NATURAL GAS REGULATOR

- .. The Natural Gas regulator has been attached to the manifold. Attach the Gas Hose to the regulator as show in figure below.
- .. Put the Gas Hose through the hole on back of the cart panel.
- .. Link a quick-connect fitting to house by hand. Quick-connect fitting not included.

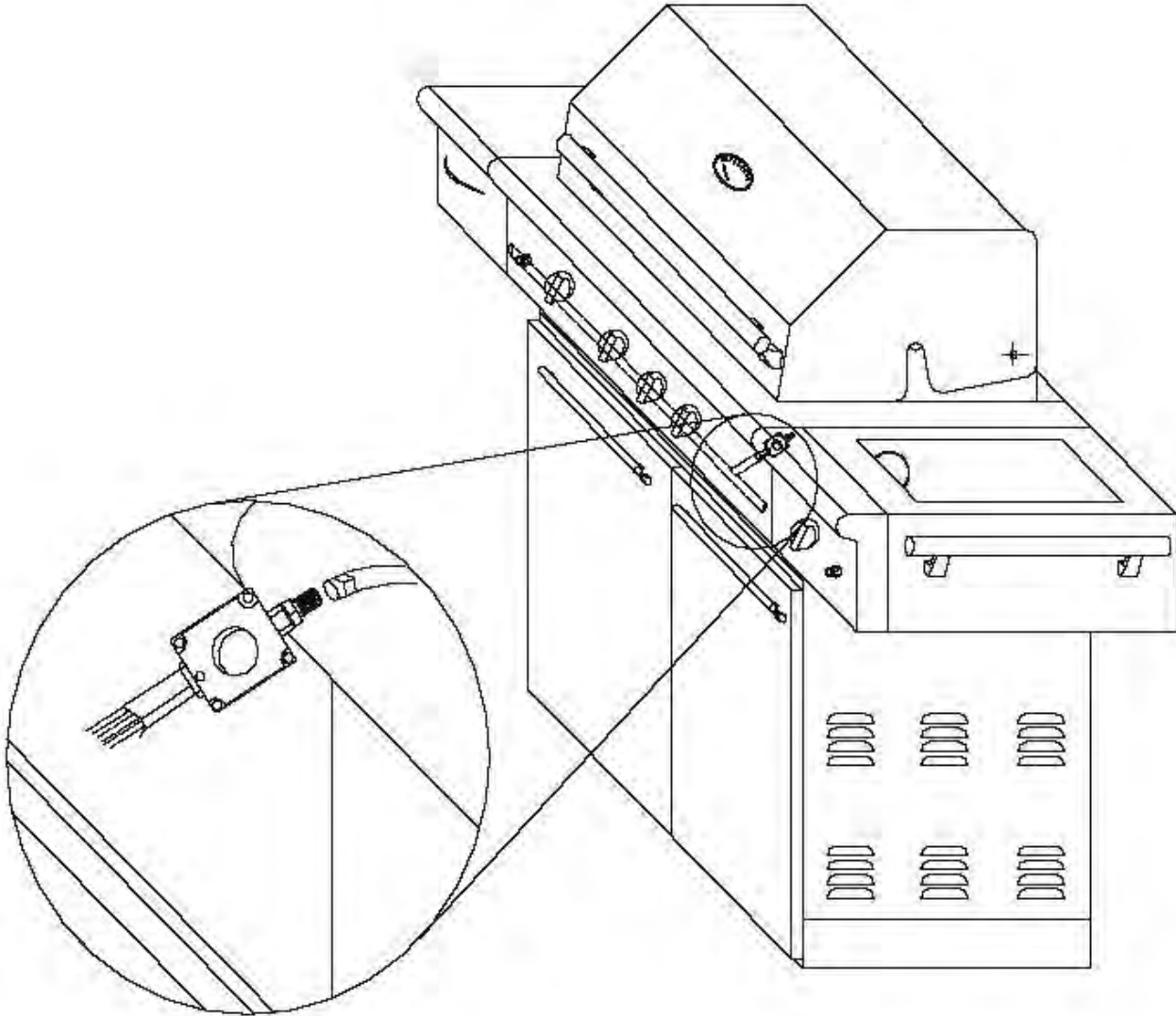

L.P. GAS INSTALLATION

Frigidaire Gas Grills that are set to operate with L.P. gas come with a high capacity hose and regulator assembly.



(Note: Only use the pressure regulator and hose assembly supplied with the grill or a replacement pressure regulator and hose assemblies specified by Frigidaire).

This assembly is designed to connect directly to a standard 20 lb. L.P. cylinder. L.P. Cylinders are not included with the grill. L.P. cylinders can be purchased separately at an independent dealer.



L.P. TANK INFORMATION

Never use a dented or rusted L.P. tank or cylinder with a damaged valve.

L.P. cylinders are equipped with an O.P.D(Overfilling Prevention Device). The device shuts off the flow of gas to a cylinder after 80% capacity is reached. This limits the potential for release of gas when the cylinder is heated, averting a fire or possible injury.

The L.P. cylinder must have a shut-off valve terminating in an L.P. gas supply cylinder outlet specified, as applicable, for connection No. 510 in the standard for compressed gas cylinder valve outlet and inlet connection ANSI/CGAV1. Cylinders must not be stored in a building, garage, or any other enclosed area. (The L.P. cylinder must have an overfill protection device, OPD, on it.)

The L.P. gas supply cylinder must be constructed and marked in accordance with the specifications for L.P. gas cylinders of the U.S. Department of Transportation (DOT) or the National Standard of Canada, CAN/CASB339, "Cylinders, Spheres and Tubes for the Transportation of Dangerous Goods."

L.P. TANK USE

- **When turning the L.P. tank on, make sure to open the valve SLOWLY two (2) complete turns to insure proper gas flow. Most gas tanks now come equipped with a leak detector mechanism internal to the tank, when gas is allowed to escape rapidly it shuts off the gas supply. Opening the valve rapidly may stimulate a gas leak, causing the safety device to inactivate, restricting gas flow causing low flames. Opening the valve slowly will insure this safety feature is not falsely triggered.**
- When not in use, gas supply cylinder valve is to be in the "OFF" position.
- The tank supply system must be stored upright to allow for vapor withdrawal.
- The regulator and hose assembly must be inspected before each use of the grill. If there is excessive abrasion or wear or if the hose is cut, it must be replaced prior to the grill being used again.
- Cylinders must be stored outdoors out of the reach of children and must not be stored in a building, garage or any other enclosed area.
- Only a qualified gas supplier should refill the L.P. tank.

- Do not store a spare L.P. gas cylinder under or near the grill.
- The cylinder used must include a collar to protect the cylinder valve.

LP GAS HOOK-UP:

Ensure that the black plastic grommets on the LP cylinder valve are in place and that the hose does not come into contact with the grease tray or the grill head.

CONNECTION:

Your grill is equipped with gas supply orifices for use only with liquid propane gas. It is also equipped with a high capacity hose/regulator assembly for connection to a standard 20lb. LP cylinder (18-1/4" high, 12-1/4" diameter).

To connect the L.P. gas supply cylinder:

1. Make sure tank valve is in its full off position (turn clockwise to stop).
2. Check tank valve to ensure it has proper external male threads (type 1 connection per ANSIZ21.81).
3. Make sure all burner valves are in the off position.
4. Inspect valve connections, port and regulator assembly. Look for any damage or debris. Remove any debris. Inspect hose for damage. Never attempt to use damaged or obstructed equipment. See your local LP gas dealer for repair.
5. When connecting regulator assembly to the valve, hand tighten the nut clockwise to a complete stop. Do not use a wrench to tighten. Use of a wrench may damage the quick coupling nut and result in a hazardous condition.
6. Open the tank valve fully (counterclockwise). Use a soapy water solution to check all connections for leaks before attempting to light the grill. See below. If a leak is found, turn the tank valve off and do not use the grill until a local LP gas dealer can make repairs.

To disconnect LP gas cylinder:

1. Turn the burner valves off.
2. Turn the tank valve off fully (turn clockwise to stop).
3. Detach the regulator assembly from the tank valve by turning the quick coupling nut counterclockwise.

LEAK TESTING

BEFORE TESTING

Do not smoke while leak testing. Extinguish all open flames. Never leak test with an open flame.

Mix a solution of equal parts mild detergent or liquid soap and water.

TESTING:

1. Turn off the burner control knobs.
2. Turn the top knob of the fuel supply cylinder counter-clockwise (right to left) two (2) rotations to open.
3. Apply the soap solution to connections of the fuel supply assembly. If no soap bubbles appear, there is no gas leak. If bubbles form at the connections, a leak is detected. If a leak is detected, immediately turn off the gas supply, tighten any leaking fittings, turn gas on, and repeat steps 1-3.
4. Turn off the knob on the fuel supply cylinder.
5. Turn on the burner control knobs for a moment to release the pressure in the hose, then turn the control knobs back off.
6. Wash off soapy solution with cold water and towel dry.

Check all gas supply fittings before each use and each time the gas supply cylinder is connected to the regulator.

Have a qualified service technician leak test the grill any time a part of the gas system is replaced.

Also it is recommended to perform a leak test at least once a year whether or not the L.P. gas supply cylinder has been disconnected.

NOTE: When leak testing this appliance, make sure to test and tighten all loose connections, including the side burner.

A slight leak in the system can result in a low flame, or hazardous condition. Most L.P. gas tanks now come equipped with a leak detector mechanism internal to the tank, when gas is allowed to escape rapidly it shuts off the gas supply. A leak may significantly reduce the gas flow making the grill difficult to light or causing low flames.

SECTION B - GAS SUPPLY

⚠ WARNING **ALWAYS TURN THE GAS SUPPLY OFF BEFORE DISCONNECTING ANY GAS LINES.**

The two types of gas used as fuel for grills are Natural and Liquid Propane (L.P.). Natural gas is rated at 1000 BTU per cubic foot and is about 1/2 heavy as air. L.P. gas is rated at 3000 BTU per cubic foot and is about twice as heavy as air. Because of the differences in BTU ratings, orifices used for natural gas are larger than orifices for L.P. Because of the differences in weight, L.P. is used under higher pressure than natural so that the proper air to gas mixture is obtained. If L.P. gas is used on a grill with a natural gas pressure regulator and orificing the burner flames will be larger (4 or 5 inches) and yellow. If natural gas is used on a grill with a L.P. gas pressure regulator and orificing, the burner flames will be small, about 1/4 inch, and yellow.

Frigidaire grills are manufactured as either natural or LP gas grills. They may be converted in the field, using a conversion kit. The gas supply is connected to the grill's pressure regulator. The pressure regulators on the natural gas models are designed to operate with incoming gas pressure between 5 and 14 inches of water column pressure and regulated output of 4 inches water column pressure under flow. The pressure regulator on LP models are designed to operate with incoming gas pressure between 11 and 14 inches of water column pressure and a regulated output of 10 inches of water column pressure under flow.

Note: If the incoming gas pressure is above 14 inches of water column a step down pressure regulator must be add to gas line before the grill pressure regulator. If the gas pressure applied to the grill regulator is above 14 inches the pressure regulator will start to lock closed and the output pressure will be reduced, causing the burner flame to turn yellow.

Gas pressure regulators reduce the incoming gas pressure and maintain a constant output pressure by increasing or decreasing the volume of gas that flows in the gas system of the grill. Regulator can not increase the incoming pressure. If the incoming pressure is below 5 inches on natural or 11 inches on LP the output pressure will be 1/2 inch below the incoming pressure. When gas pressure is below the designed operating pressure the burner flames will be smaller and yellow.

Natural gas is delivered to the home by an underground pipe. The natural gas supply line for the grill need to be a minimum of 1/2 inch I.D. If the supply line is too small the burner flames will get smaller, the more burners that are turned on.

LP gas is supplied in two ways; In a large tank that is designed to supply a complete house and in small 20 lb cylinders. When the grill is connected to a gas system supplied by a large tank, the tank will have a pressure regulator at the tank that controls the pressure in the system. If a pressure problem occurs at the grill check other gas using products in the house to see if they have a pressure problem. If they have a pressure problem also, the problem is in house gas system and the customer should call their gas supplier. If the pressure is good in the house check the connection to the grill's pressure regulator for any restriction, if no restriction replace the regulator.

20 lb cylinders have two safety devices built into the OPD valve. (shutoff valve) The first is a float that prevents tank from being filled more than 80%. The second is a spring and ball bearing system that restrict the gas flow from the tank if the pressure in the grill's gas system does not equalize to the tank pressure when the OPD valve is first turn on. This is to prevent maximum gas flow with a leak in the system. The restriction will also take place if a valve on the grill is turned on when the OPD valve is opened or the OPD valve is turn on very fast.

SECTION C - IGNITION SYSTEM

Battery power models

The number of igniters will vary with the size and features of the model, but spark ignition system operates basically the same on all models.

The ignition system is made up of six components:

1. AA or AAA battery to supply power.



2. Battery holder with igniter button switch.



3. Spark module.

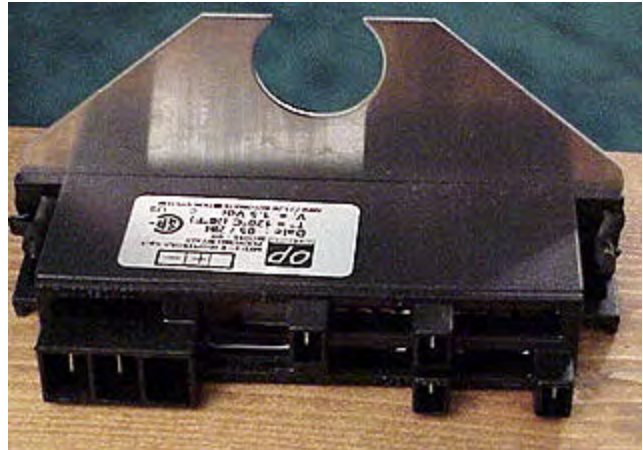

4. High voltage wire.



5. Igniter.

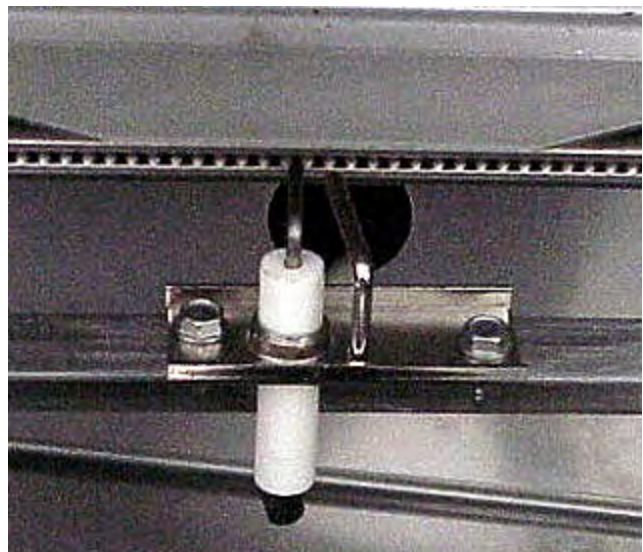

6. Chassis.

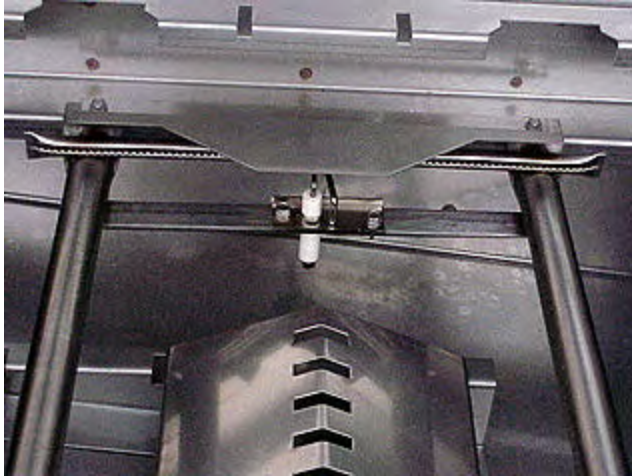

When the igniter button is pushed on the battery holder 1 1/2 volts is applied across the input terminals of the spark module. The module then steps the voltage up to about 15,000 volts. It is easier to understand module and igniter circuit if we look at a simple charging circuit. The circuit is made up of a transformer secondary used to step up the voltage, a diode used to rectify the current, a capacitor used to store an electrical charge, a resistor used to slow down the charging of the capacitor, igniter tips provide the air gap that create the spark, and the grill chassis provided the path for current to flow between the igniters.

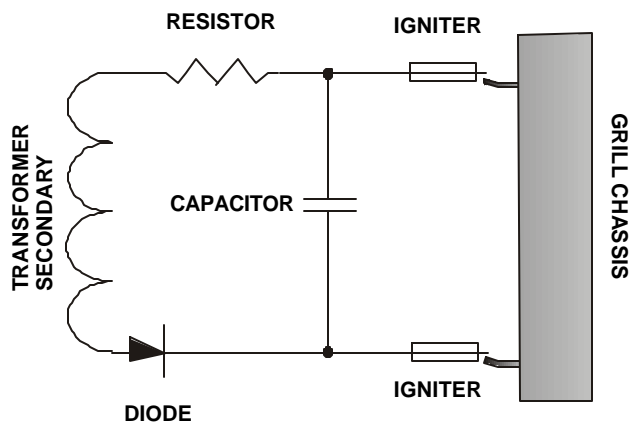

When power is applied to the circuit, electrical current flows in the circuit formed by the diode, transformer, resistor and capacitor, charging the capacitor negative to positive. Current does not flow in the igniter/chassis circuit because of the high resistance of the air dielectric between the igniter points, but the capacitor and igniter/chassis circuits are in parallel.

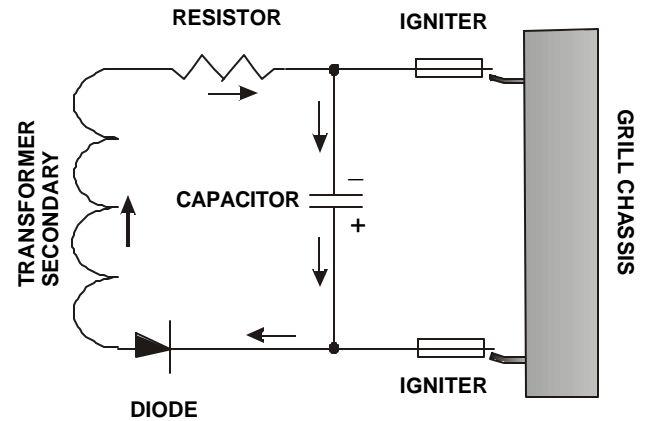

The diode blocks the discharge path of the capacitor so the capacitor continues to charge until the charge on the capacitor is high enough to break down the dielectric of the air between the igniter points. When the dielectric breaks down, the spark jumps between the igniter points. When the spark jumps, it creates a short between the igniter points, current flows in the capacitor, igniter/chassis circuit, discharging the capacitor.

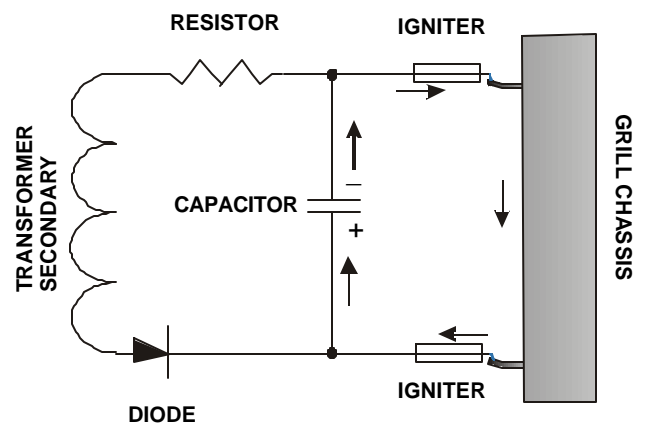

With the capacitor discharged, the electrical difference drops below the dielectric breakdown point, and the capacitor starts to charge again. This cycle will continue as long as the button is held in.

Note: All igniters on the grill should spark whenever the start button is pushed.

Problems that can occur in the system are:

1. Battery failure: If the battery fails, no power is applied, and the system becomes completely inoperative.

Correction: Test the battery under load, and if necessary, replace the battery.

2. Battery holder or switch failure. If the holder or switch fails, no power is applied, and the system becomes completely inoperative.

Correction: Disassembly and clean. If necessary replace the battery holder.

3. Module failure (No snapping sound): When the module fails the system becomes completely inoperative.

Correction: Since other failures can cause the module not to snap, remove the output wires from the module and push the start button. Listen to hear if the module snaps. If the module snap the output wires are shorted. If the module does not snap measure the voltage at the battery holder with the button push in. If the reading is below 1 volt check the battery and the holder. If the reading is above 1 volt inspect the input wiring to the module. If wiring is good replace the module.

4. Output wiring failed open (3 igniter grill): If an output wire fails open the igniter that the wire is connected to will not spark.

5. Output wiring failed open (4 igniter grill): If an output wire fails open 2 out of the 4 igniter will not spark.

6. Output wire or igniter shorts to chassis: A short to chassis bypasses the igniter between the short and chassis. The other igniters will spark.

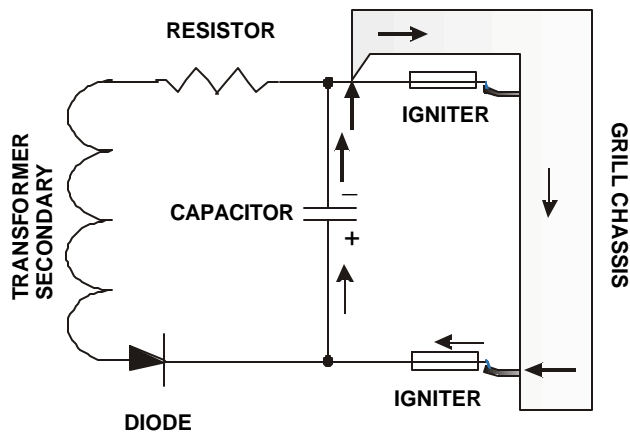

7. Igniter tip shorted out to chassis by grease: Inspect and clean igniter as need.

SECTION D - TROUBLESHOOTING FLOW CHARTS

Grill completely inoperative. (Grill connected to natural or large L.P. tank)	20
Grill completely inoperative. (Grill connected to 20 lb L.P. tank)	21
Igniters do not spark.	22
Some of the burners will not operate.	23
All burner flames yellow and way to large.	23
All burner flames small (about 1/4 inch).	24
Ceramic burner pops and flutters.	25
Igniter sparks tip to chassis not tip to tip.	26
Grill hotter in back than in front.	26
Grill hotter in back than in front. (Model with serial number that start with the letter "L")	26

Grill completely inoperative. (Grill connected to natural or large L.P. tank)

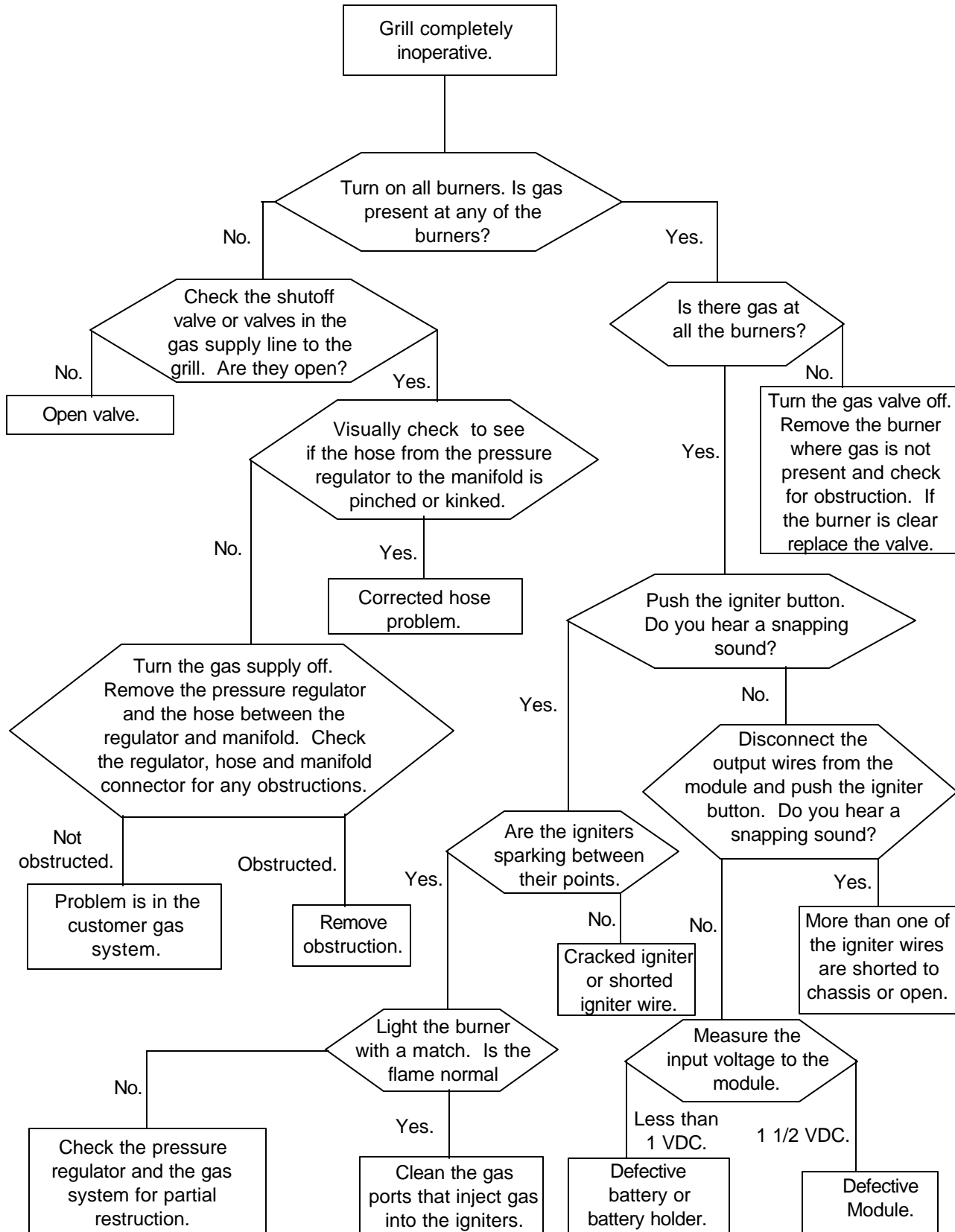

Grill completely inoperative. (Grill connected to 20 lb L.P. tank)

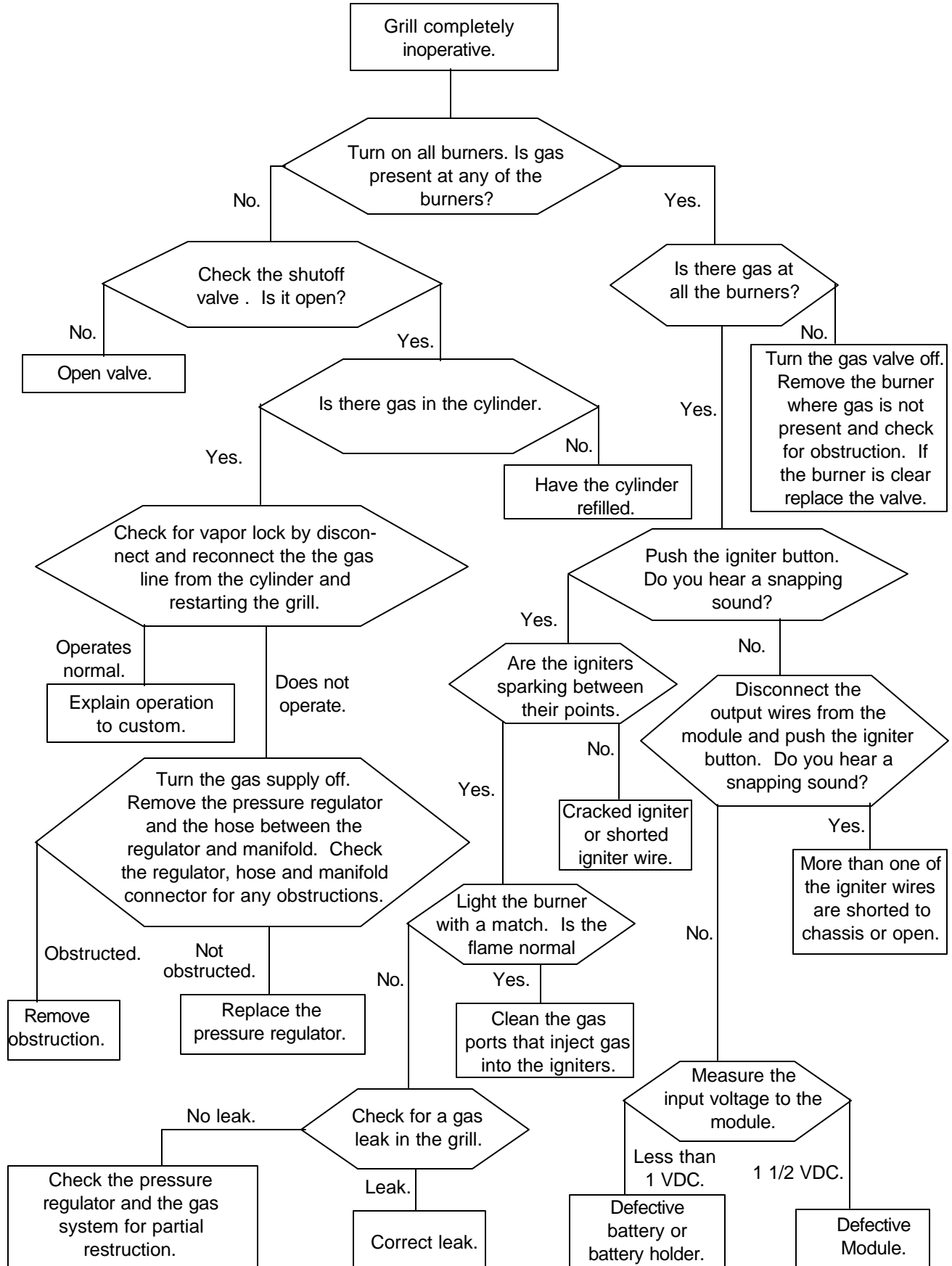

Igniters do not spark.

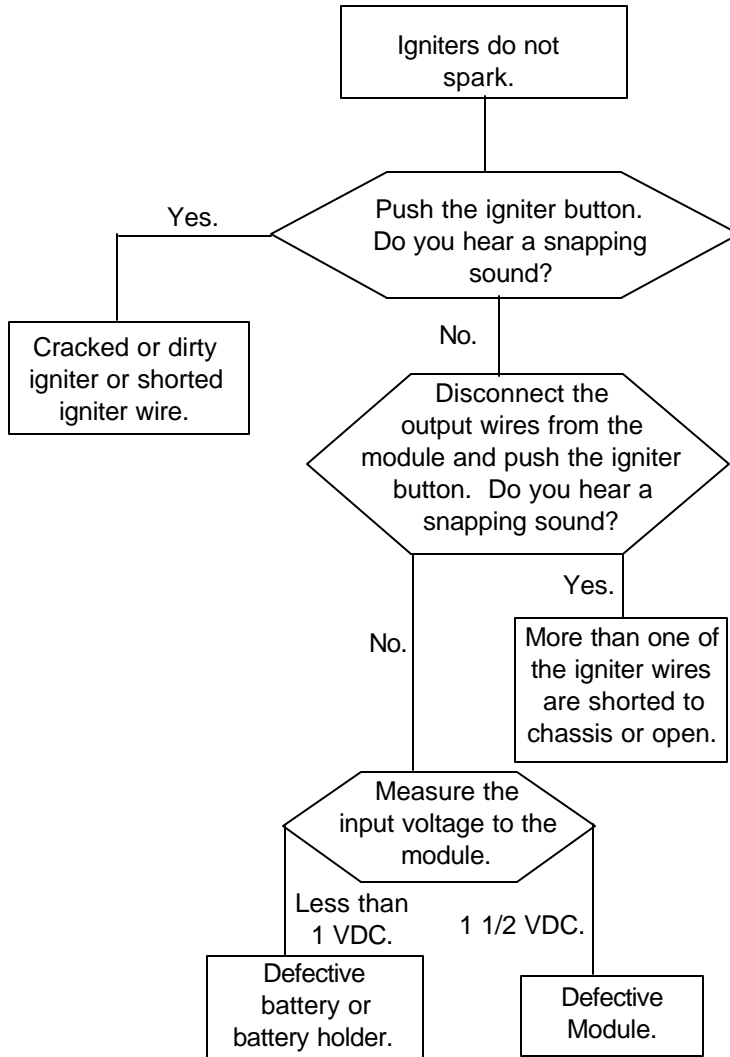

Some of the burners will not operate.

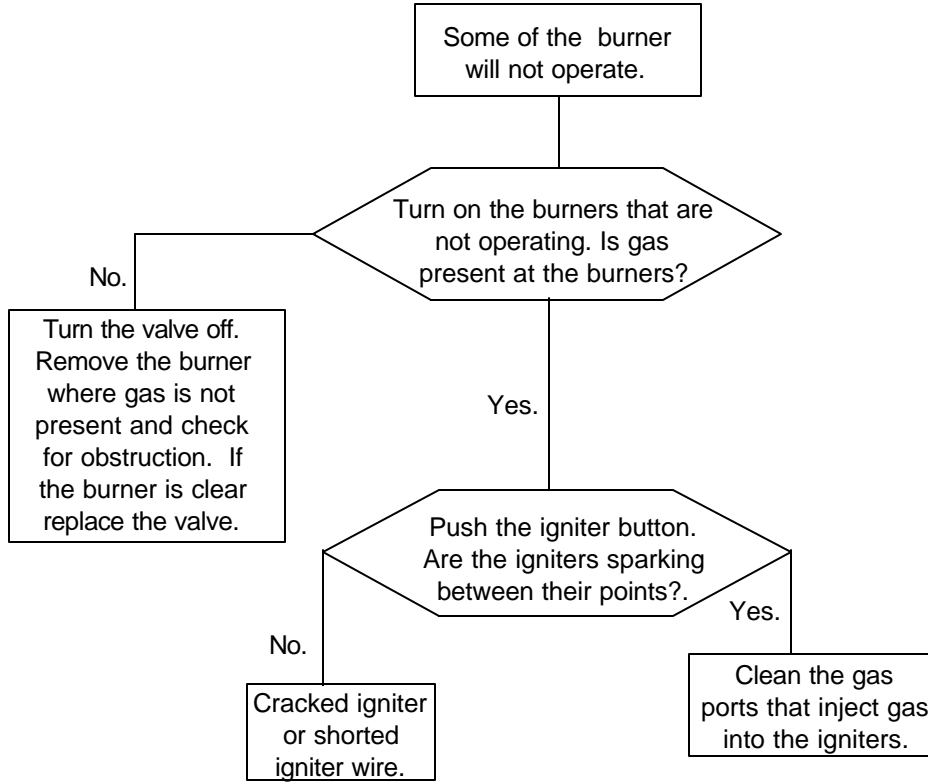

All burner flames yellow and way to large.

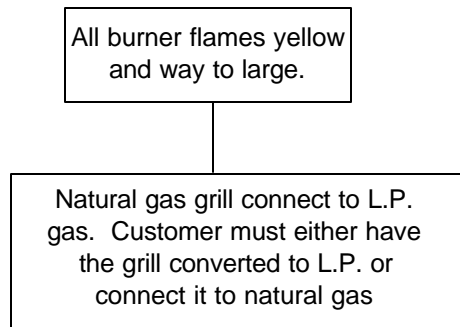

All burner flames small (about 1/4 inch).

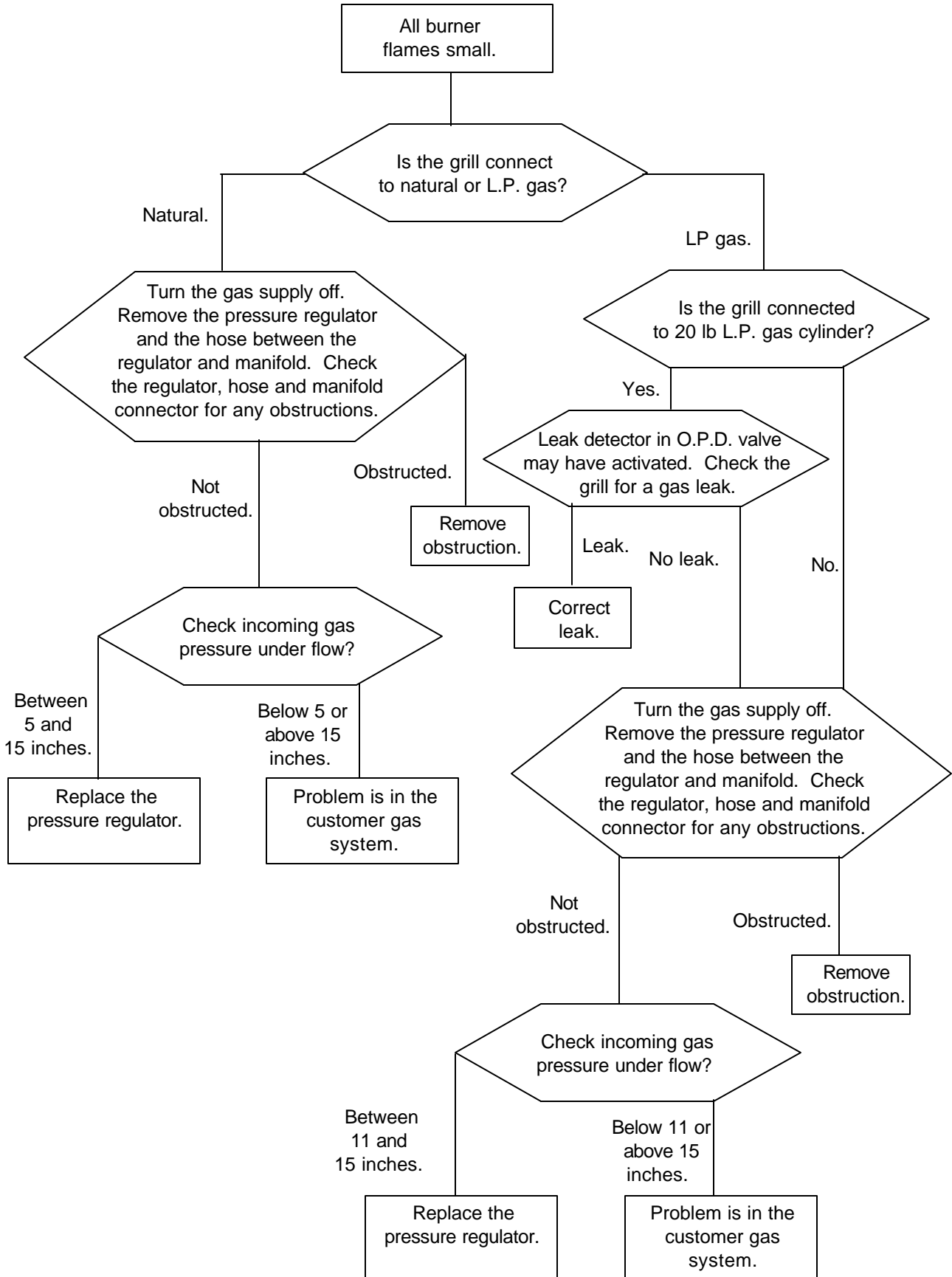

Burner flame is mostly yellow or orange, possibly in conjunction with smell of gas.

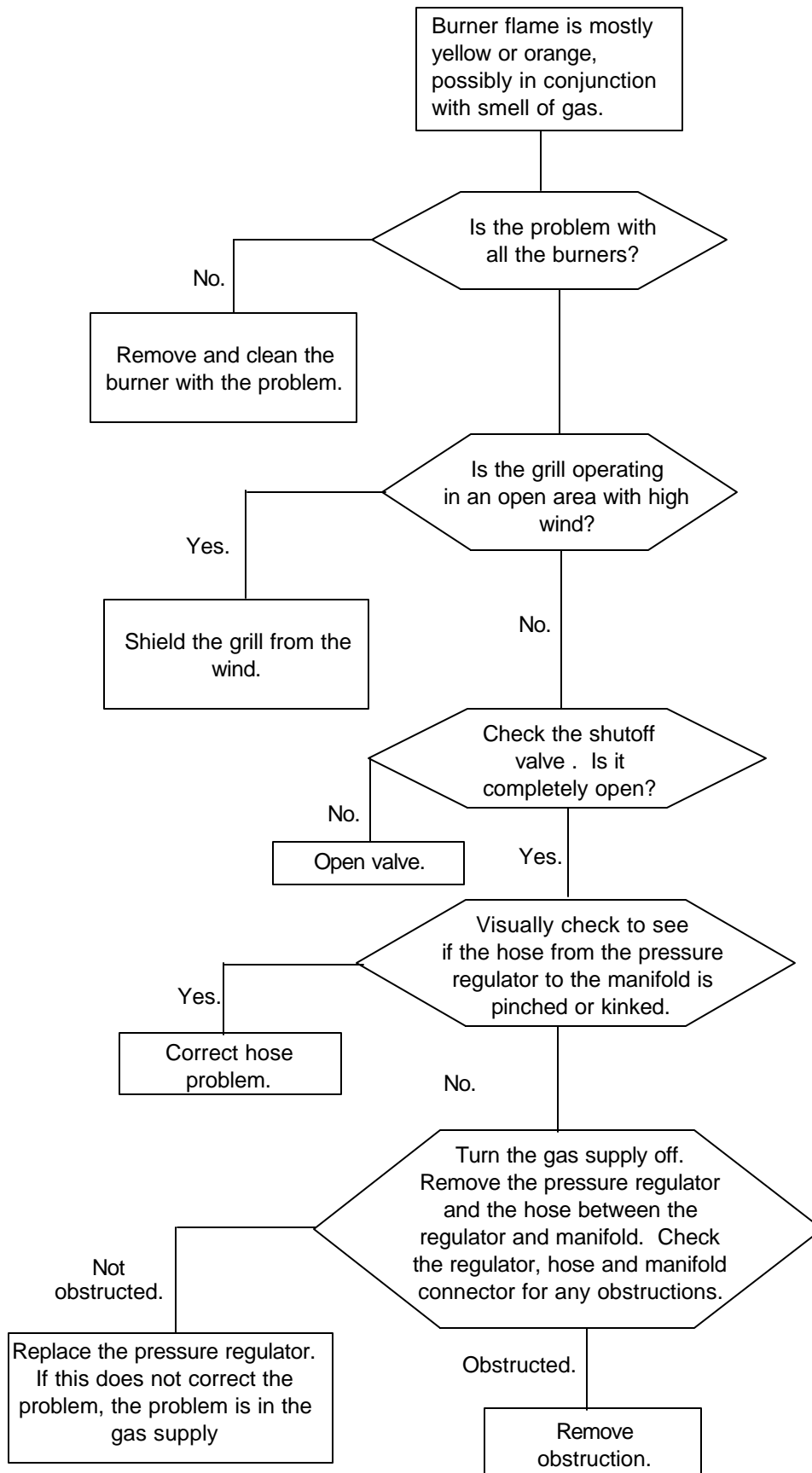

Ceramic burner pops and flutters.

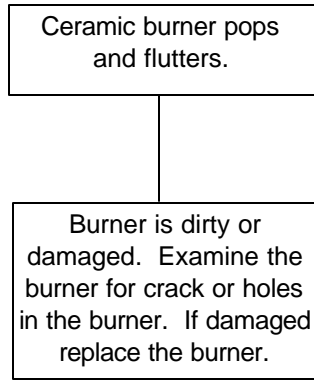

Igniter sparks tip to chassis not tip to tip.

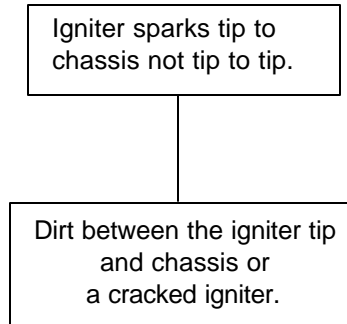

Grill hotter in back than in front. (Model with serial number that start with the letter "L")

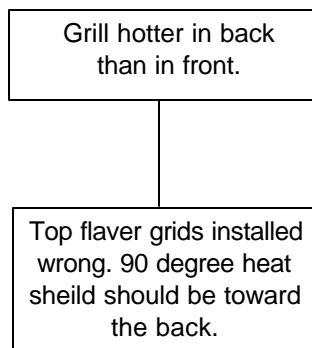

SECTION E - TEARDOWN (MODELS WITH SERIAL NUMBER STARTING WITH THE LETTER "L")

This section will describe how to remove components from grill. Unless stated, the procedure will be the same on all grills. Unless stated, reverse the procedure to reinstall the component.

Note: This section will cover the teardown of grill manufactured before and after October 2004. If the location or removal of the part is different both will be shown

⚠ WARNING Always remove electrical power from the grill when working in an area where electrical power is present.

⚠ WARNING Always turn the gas off to the grill before opening any gas piping.

Note: All components may not be on all models.

Note: All screws used in the grills are stainless steel. To prevent rust use only stain steel screws when for replacing.

Removing the temperature gauge:

1. Raise the roll top grill hood, remove the nut holding gauge to hood and lift the gauge out the front.

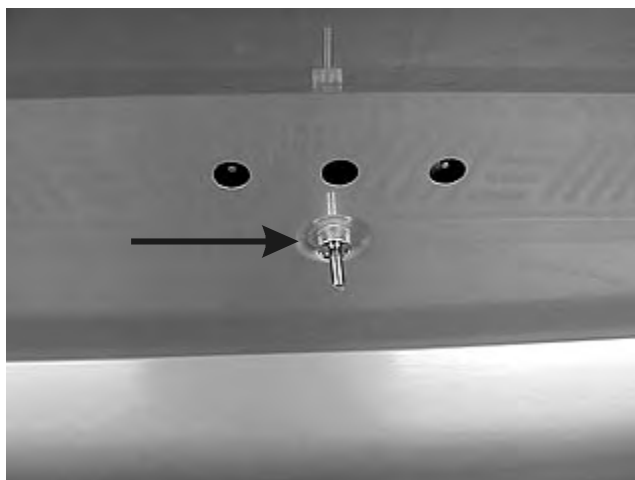

Removing the roll top grill hood handle end caps:

1. Raise the roll top grill hood, using a 3/16" allen wrench remove the (2) allen screws holding the end cap to the roll top.

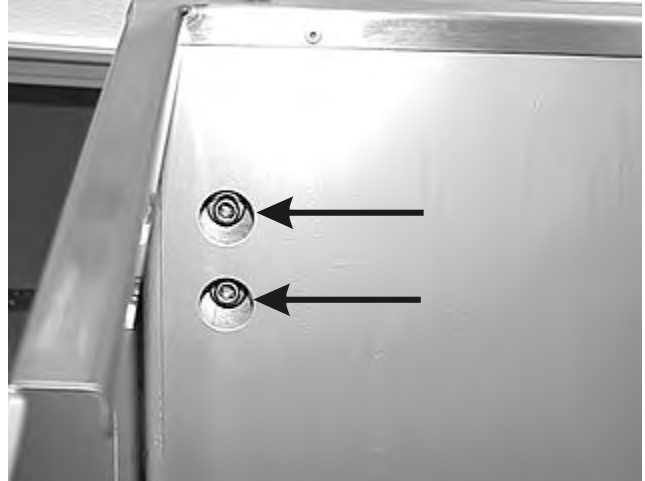

2. Slide the end cap off the handle.



Removing the roll top grill hood handle:

1. Remove one of the handle end caps and slide the handle out of the other end cap.

Removing the roll top grill hood:

The grill hood is held to the backsplash on each end by a bolt with a 3/16" allen head and a 1/2" nut. The hood is spaced away from the backsplash by spacer washer between the hood and the backsplash.



The hole in the backsplash is threaded, the bolt is screwed through the backsplash and lock with the 1/2" nut.



1. Raise the roll top grill hood, remove the 1/2" nut from each end. Using a 3/16" allen wrench remove the bolt from each end.

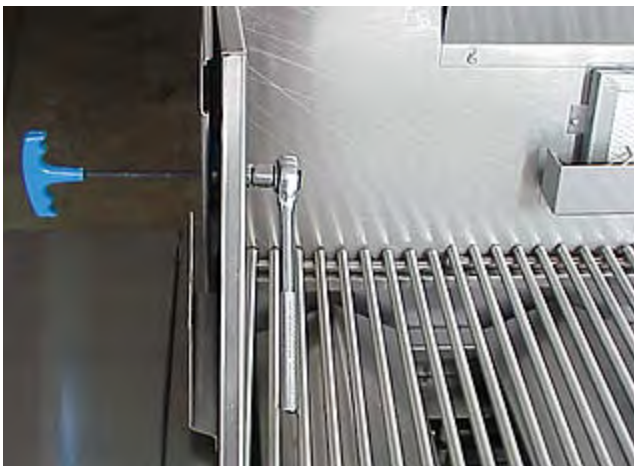

Note: The igniter battery and battery housing for the main burners are located in different areas on different size grills. On the grills with Model number starting with GL the housing is mounted to either the left or right shelf.



On grills with models number starting FD the housing is mounted in the front of the grill. Removing the battery is the same on all models.



Removing the battery:

1. Turn the front cap of the battery housing counter clockwise, remove the cap and spring and pull the battery out.



3. Remove the locking nut from the front of the housing and pull the housing out the back.



Removing the battery housing: (GL models)

1. Remove the cap, spring and battery.
2. Disconnect the (2) wires from the battery housing.



Note: The battery housing holds the burner spark module bracket to the inside of the shelf.

Removing the battery housing: (FD models)

1. Remove the cap, spring and battery.
2. Remove the (2) screws holding the module access panel to the grill.



3. Remove the locking nut from the front of the grill.



4. Pull the igniter module and battery housing out through the access panel opening



2. Loosen the (4) bolts, (2) in the front and (2) in the rear, and lift the shelf off.



Removing the burner spark module:

1. Unplug the wires from the module.
2. Remove the battery housing.
3. Slide the spark module bracket off of the battery housing.



Removing the left shelf: (FD models)

1. Remove the (2) screws locking the shelf to the grill.



2. Lift the shelf up to disengage the tabs and pull the shelf out.

Note: On some models there are (2) batteries and modules, one on each side panel

Removing the left shelf: (GL models)

1. Remove the battery holder and the burner spark module.



Removing the back infrared burner knob:

1. The knob has a D shaped opening and pulls straight off the valve shaft.



Removing the back infrared burner knob bezel:

1. Remove the back infrared burner knob.
2. Carefully drill out the rivet holding the bezel to the chassis.



3. To reinstall use a pop rivet or a stainless steel screw.

Removing a main burner knob:

1. The knob has a D shaped opening and pulls straight off the valve shaft.



Removing a main burner knob bezel:

1. Remove the main knob.
2. Remove the screw holding the bezel to the chassis and lift the bezel off.



Removing the heat shield above back infrared burner: (This part is not on all models)

Note: The (5) screws holding the heat shield also hold the top of the back infrared cover.

1. Raise the roll top hood, remove the (5) screws holding the shield to the backsplash and lift the shield off.



Removing the back infrared burner cover:

1. Raise the roll top hood and remove the heat shield or screws, depending on the model, above the back infrared burner.

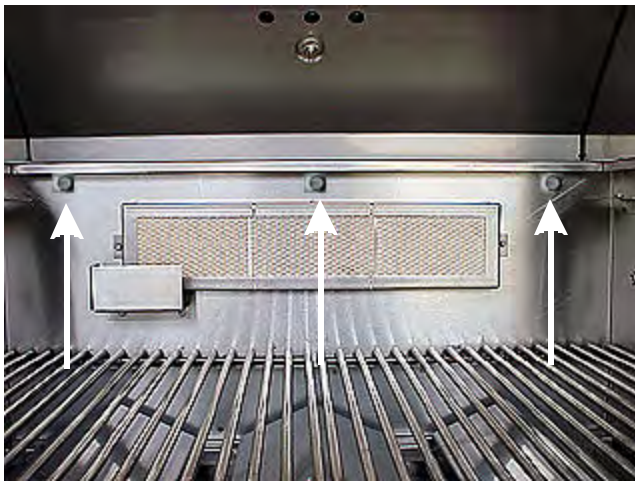

2. Close the roll top hood and lift the cover out of the slots in the chassis.



Removing the back infrared burner igniter shield:

1. Raise the roll top hood and remove the (2) screws holding the shield to the backsplash.

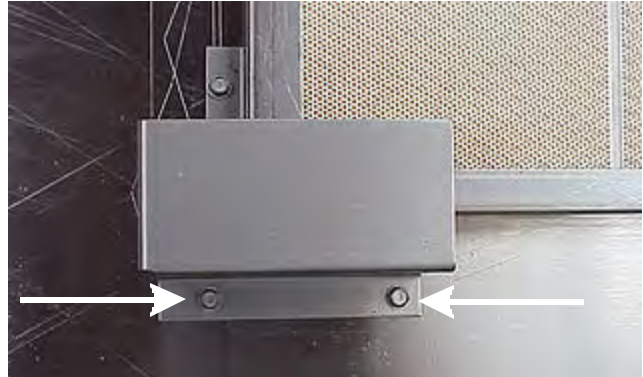

Removing the back infrared burner igniter:

1. Raise the roll top hood and remove the igniter shield.
2. Remove the (1) screw holding the igniter to the backsplash.

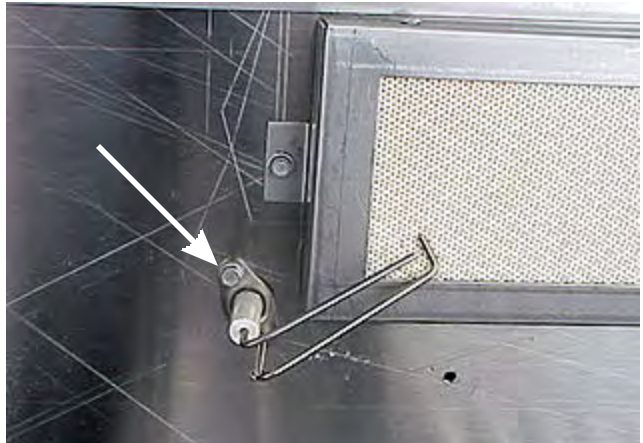

3. Pull the igniter into the grill and disconnect the wire.



Removing the back infrared burner:

1. Remove the back infrared burner cover.
2. Using a 15/16" wrench remove the pal nut locking the orifice assembly to the bracket.



3. Raise the roll top hood and remove the (2) screw (1) at each end holding the back infra burner to the backsplash.

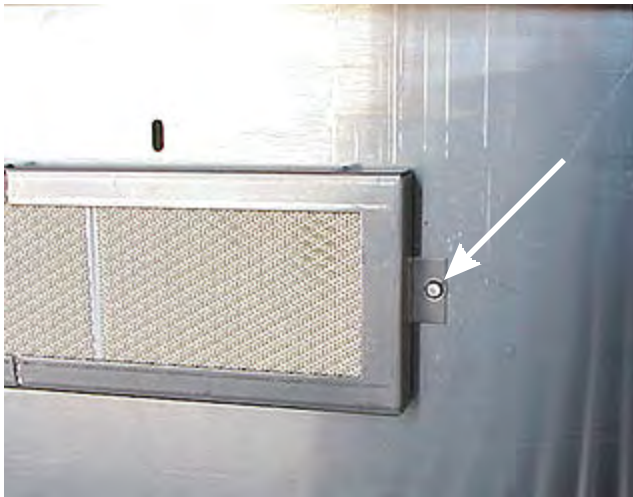

4. Pull out on the right end of the burner and slide the burner to the right and out.

Removing the back infrared burner spud:

1. Remove the back infrared burner cover.

2. Using a 1/2" wrench turn the spud counter clockwise.



Removing the back infrared burner orifice assembly:

1. Remove the back infrared burner cover.
2. Using a 3/4" wrench disconnect gas line from the orifice assembly.



- Using a 15/16" wrench remove the pal nut locking the orifice assembly to the bracket.

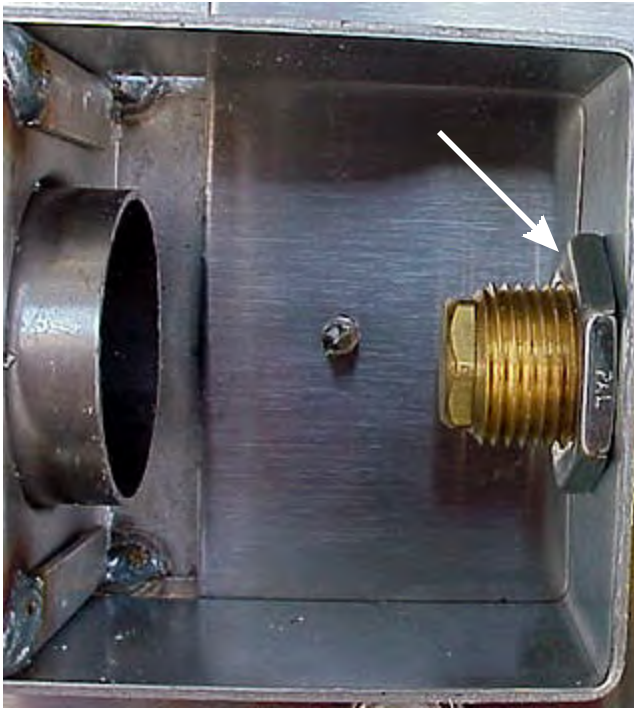

Removing the side burner grate:

- The side burner grate lift off.



Removing the side burner cap: (GL models)

- Remove the grate.
- The side burner cap lift off.



Removing the side burner head: (GL models)

- Remove the grate and burner cap.
- The side burner head lift off.



Removing the side burner: (FD models)

1. Remove the grate.
2. Remove the wing nut, underneath the shelf, that lock the burner to the shelf.



2. Using a 7 mm socket turn the orifice counter clockwise.



3. Lift up and back on the burner head to disengage the valve and lift the burner out.



Removing the side burner orifice: (FD models)

1. Remove the grate and burner head.
2. Using a 3/8" socket remove the orifice from the valve.



Removing the side burner orifice: (GL models)

1. Remove the grate, burner cap and burner head.

Removing the side burner orifice holder and tube: (GL models)

1. Turn the gas supply off.

- Using a 1/2" wrench disconnect the gas line, that goes to the burner, from the valve.



- Using a 5/8" wrench remove the nut holding the orifice holder to the burner base and drop the orifice and tube down.



Removing the side burner igniter: (GL models)

- Disconnect the wire from the igniter.
- Using a phillips screwdriver remove the (1) screw holding the igniter mount to the burner base.



Removing the side burner igniter: (FD models)

- Remove the burner and disconnect the wire from the igniter.
- Remove the screw holding the igniter to the shield and lift the igniter out.



Removing the side burner base: (GL models)

- Turn the gas supply off and remove the burner cap and head.
- Remove the igniter and orifice holder and tube.
- Using a 1/4" socket remove the (2) screws holding the burner base to the shelf.

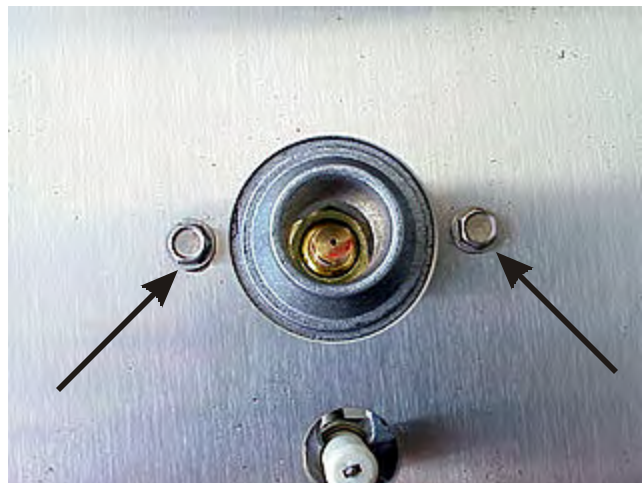

Removing the side burner valve: (GL models)

1. Turn the gas supply off and remove the side burner valve knob.
2. Using a 3/4" wrench disconnect the incoming gas line from the valve.



3. Using a 1/2" wrench disconnect the output gas line from the valve.



4. Remove the screw holding the valve to the side shelf and slide the valve back.



Removing the side burner valve: (FD models)

1. Turn the gas supply off and remove the side burner.
2. Remove the burner head.
3. Using a 3/4" wrench disconnect the incoming gas line from the valve.



4. Remove the screw holding the valve to the side shelf and slide the valve back.



Removing the side burner shelf: (GL models)

1. Turn the gas supply off and remove the side burner grate, cap burner head, igniter and burner base.
2. Remove the battery holder, spark module and side burner valve.

- Loosen the (4) bolts, (2) in the front and (2) in the rear, holding the side shelf to the chassis and lift the shelf off.

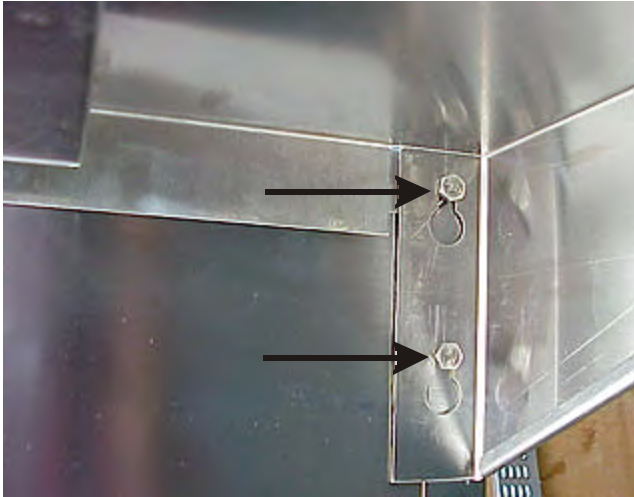

Removing the side burner shelf: (FD models)

- Turn the gas supply off and remove the side burner grate, burner and igniter.
- Remove the screw holding the bezel and valve to the shelf and pull the valve back.
- Remove the (2) screws locking the side panel in place.



- Lift the shelf up and out to disengage the tabs from the slots.



Removing the regulator and hose assembly: (Models built before October 2004)

- Turn the gas supply off and disconnect the regulator from the gas supply.
- Using a 3/4" wrench disconnect the hose from the bottom of the grill.

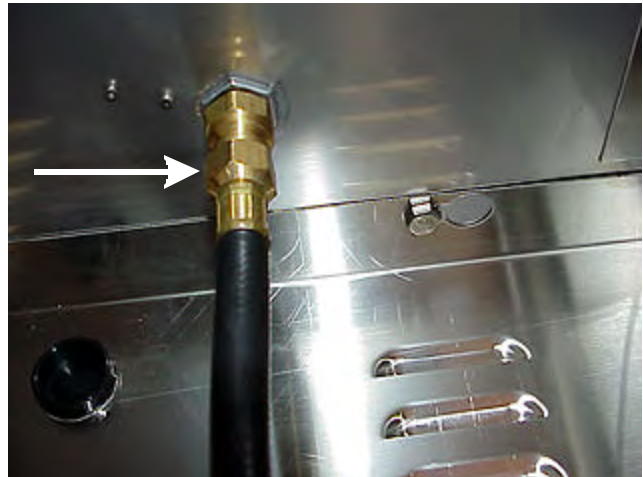

Removing the regulator and hose assembly: (Models built after September 2004)

- Turn the gas supply off and disconnect the regulator from the gas supply.

- Using a 3/4" wrench disconnect the hose from the side burner valve and pull the hose back into the cabinet.



- Using a 3/4" wrench disconnect the other hose from the manifold.

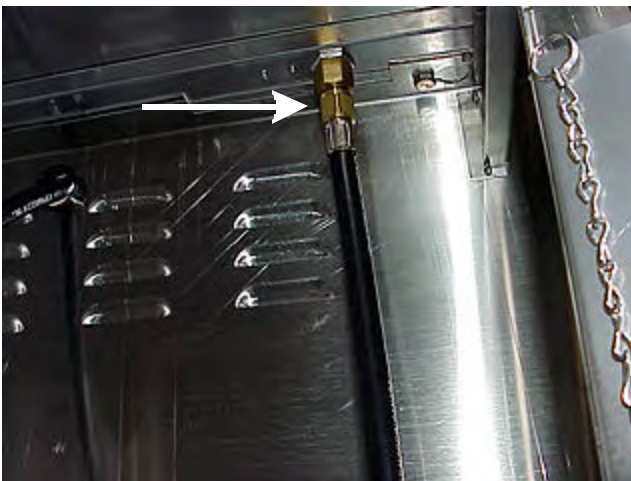

Removing the warming shelf:

- Lift the shelf up, bring it forward and down. Angle the shelf with the right side back and slide the shelf out the left front corner.



Removing the main grates:

- The main grates lift out.



Removing the top flavor grids:

- To remove the grates, lift the rear of the grid up and slide it back. Then lift the front of the grid up and out.

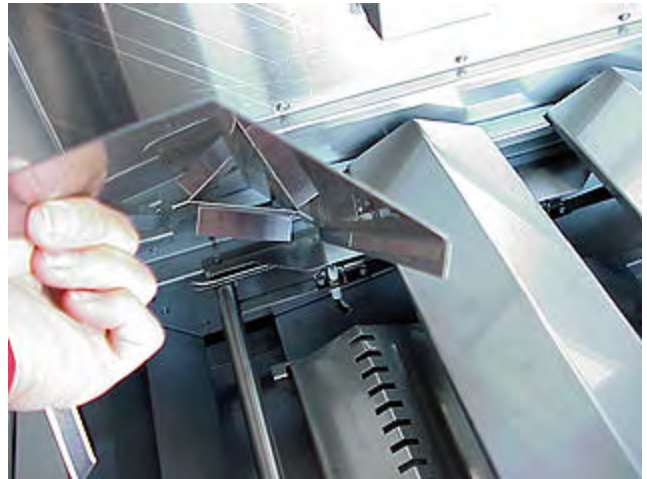

Note: When installing the top flavor grid always install the grid with the heat shield to the rear.

Removing the bottom flavor grids:

- Remove the grates and top flavor grids.

2. The bottom flavor grids lift out.

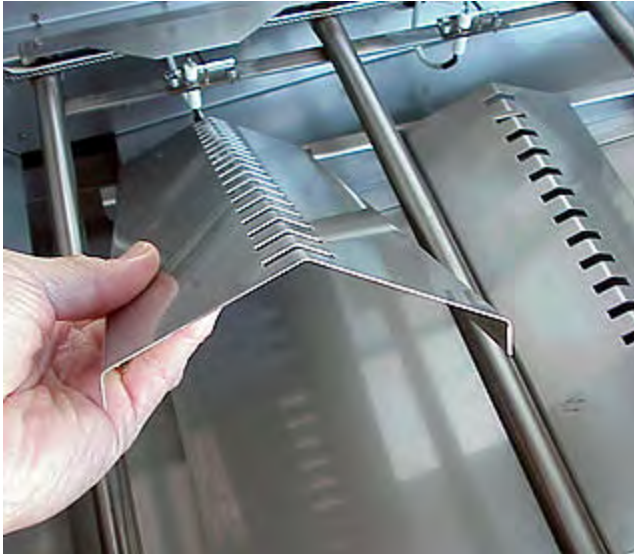

Removing the backsplash: (44" and 51" models)

1. Turn the gas supply off and remove the roll top hood.
2. Remove the back burner and back burner igniter.
3. The backsplash is held to the chassis by (14) screws, (3) on each end

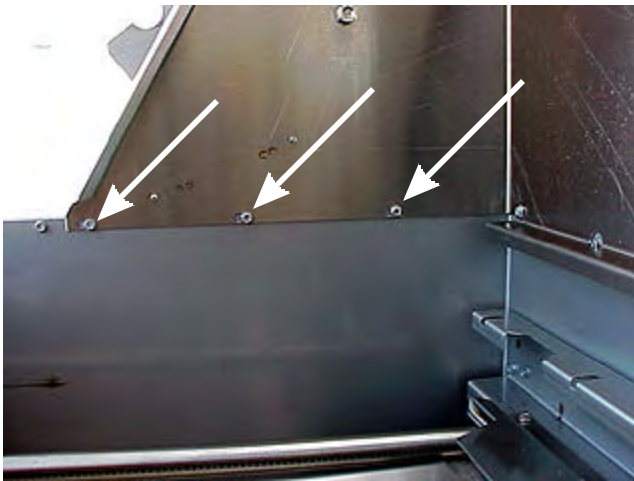

and (8) across the back.

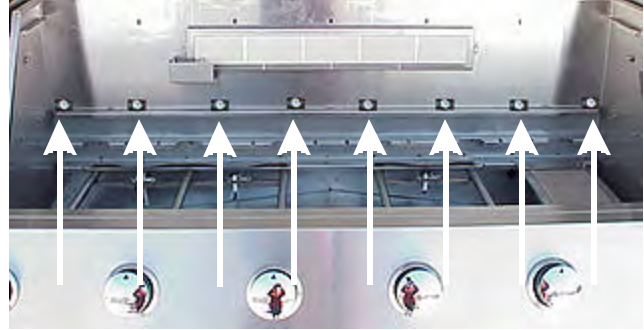

4. Remove the (14) screws and lift the back splash off.

Removing the backsplash: (38" and smaller models)

1. Turn the gas supply off and remove the roll top hood.
2. Remove the main burner assembly, bottom back heat shield, back burner and back burner igniter.
3. Remove the (8) screws, four on each end, holding the sides of the back splash to the chassis and bottom side heat shields.

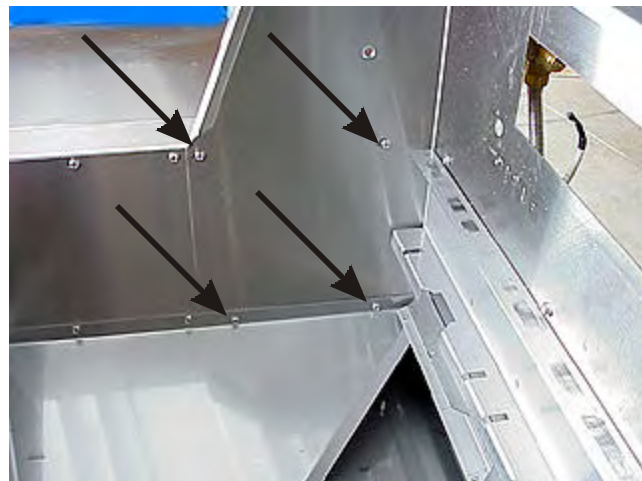

4. Remove the (4) or (5) screws, depending on the model, holding the rear of the backsplash to the chassis.

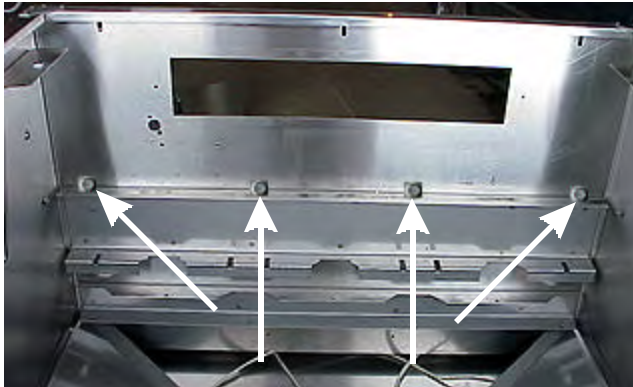

Removing the (3) burner crossover shield:

1. Remove the grates and flavor grids.
2. Using a 1/4" socket remove the (3) screws holding the shield to the burner mounting brace.

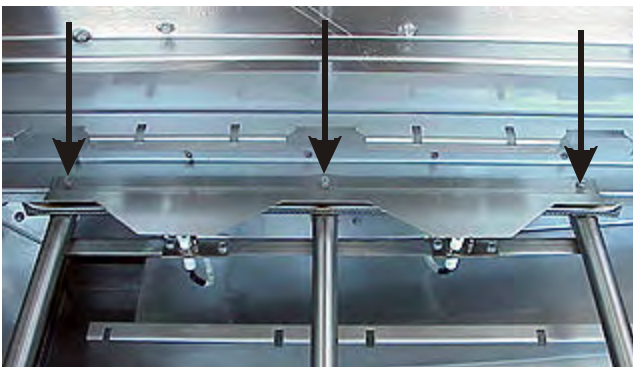

Removing the (2) burner crossover shield:

1. Remove the grates and flavor grids.
2. Using a 1/4" socket remove the (2) screws holding the shield to the burner mounting brace.



Removing the main burner igniters:

1. Remove the grates, the flavor grids and cross over shield.
2. Disconnect the wire from the igniter and remove the (2) screws holding the igniter to the burner bar.

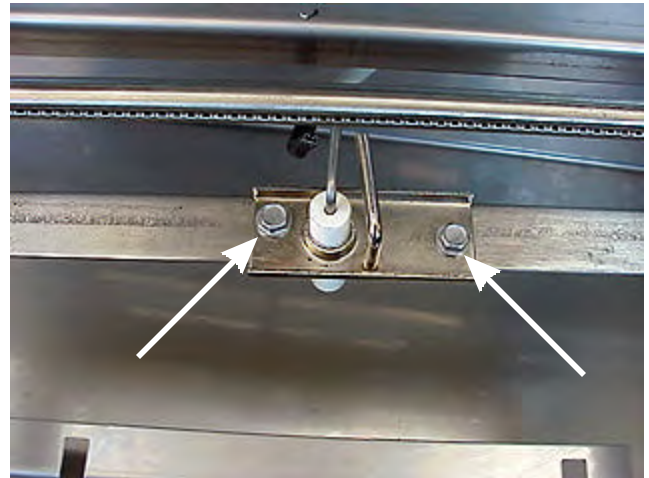

Removing the main burners: (44" and 51" models)

1. Remove the grates, the flavor grids and cross over shield.
2. Remove the igniter and lift the burner to the rear and up.



Removing the main burners: (38" and smaller models)

1. Remove the grates, the flavor grids and cross over shield.

2. Remove the igniter.
3. Remove the (7) or (8) screws, depending on the model, holding the front heat shield to the side heat shields and the chassis. Two on each end holding the front heat shield to the side heat shield and the chassis and

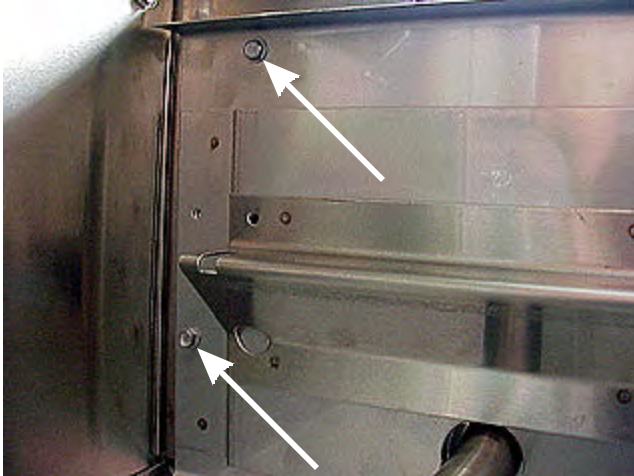

the three across the top holding the front heat shield to the chassis.

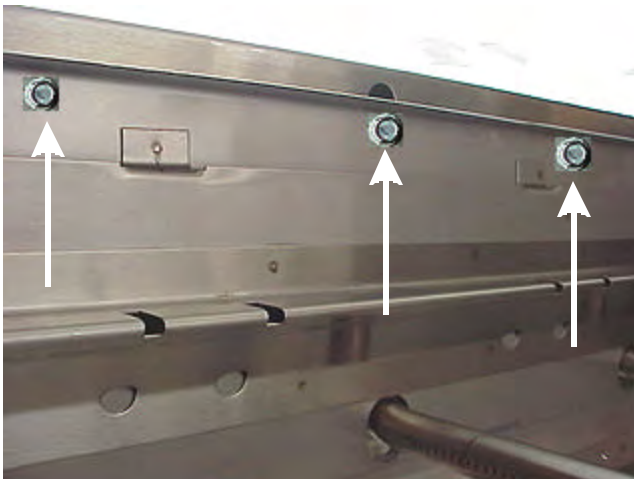

5. Let the front heat shield drop down and pull the burner assembly out.



Replacing the igniter high voltage wire:

1. Remove the grates, the flavor grids and cross over shield.
2. Disconnect the wire from the module and the igniter.
3. Tape the replacement wire to the end of the wire that was connected to the igniter. Pull the replacement wire through the channel by pulling on the module end of the wire to be replaced.



Removing the bottom infrared burner igniter shield:

1. Remove the grate and flavor grid above the bottom infrared burner.

2. Remove the (2) screws holding the shield to the front burner mounting bracket and lift the igniter shield out.

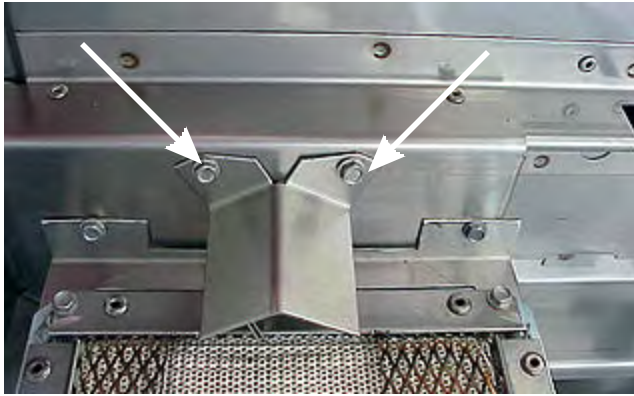

Removing the bottom infrared burner igniter:

1. Remove the grate and flavor grid above the bottom infrared burner.
2. Remove the igniter shield.
3. Remove the screw holding the igniter to the front burner mounting bracket. Pull the igniter out and unplug the wire from the igniter.

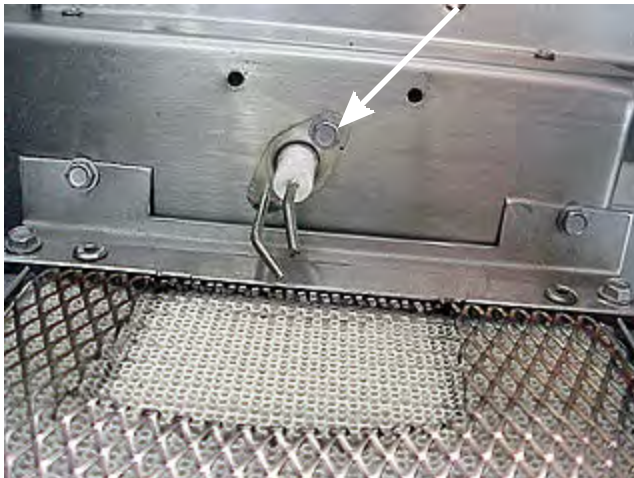

Removing the bottom infrared burner:

1. Remove the grate and flavor grid above the bottom infrared burner.

2. Remove the (2) screws holding the burner to the front burner mounting bracket.

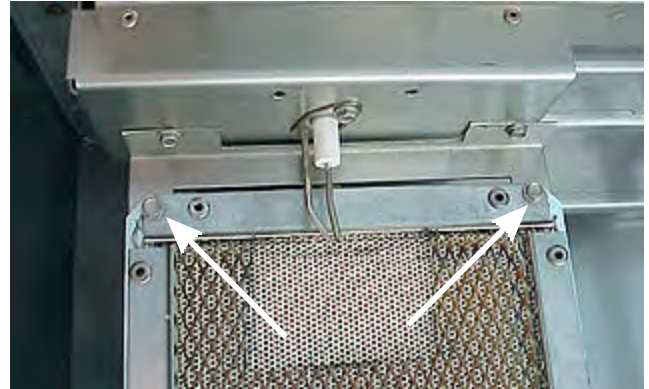

3. Remove the (2) screws holding the burner to the rear burner mounting bracket.

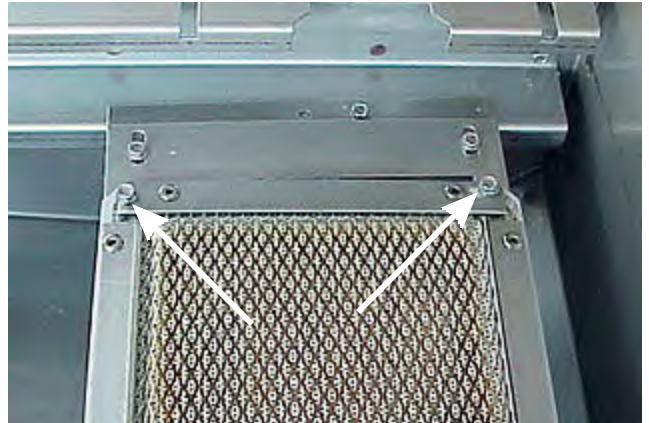

4. Raise the rear of the burner up and pull the burner toward the back of the grill to release the burner from the spud.

Removing the bottom infrared burner rear mounting bracket:

1. Remove the grate and flavor grid above the bottom infrared burner.
2. Remove the (2) screws holding the burner to the rear burner mounting bracket.



3. Remove the (2) screws holding the rear burner mounting bracket to the burner mounting bar and lift the bracket out.

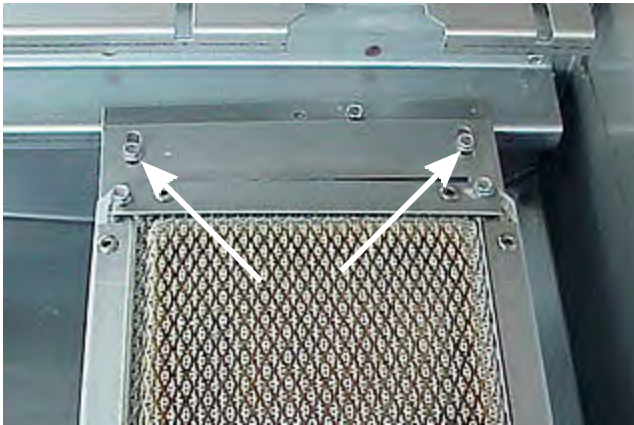

Removing the bottom infrared burner front mounting bracket:

1. Remove the grate and flavor grid above the bottom infrared burner.
2. Remove the (2) screws holding the burner to the front burner mounting bracket.

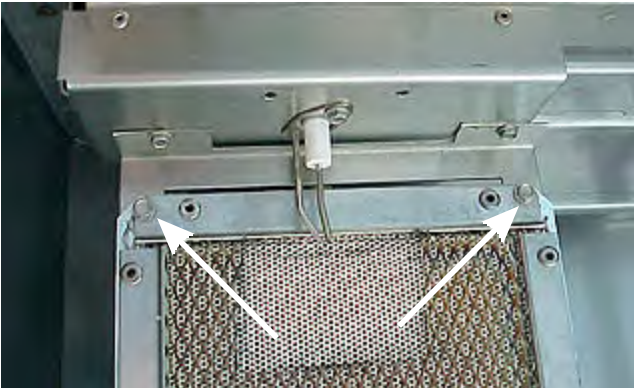

3. Remove the (2) screws holding the front burner mounting bracket to the front heat shield and lift the bracket out.

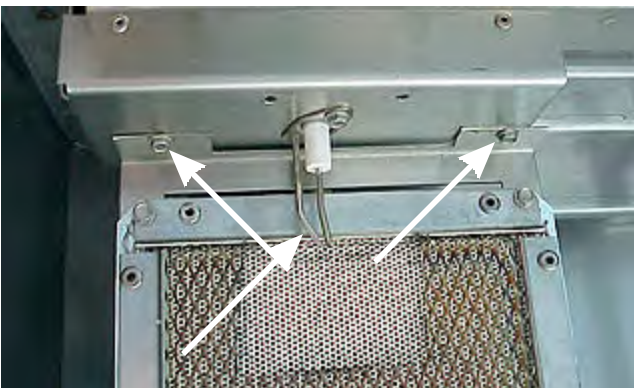

Removing the bottom infrared burner valve orifice:

1. Remove the grate and flavor grid above the bottom infrared burner.
2. Remove the burner.
3. Using a 7 mm socket turn the orifice clockwise.



Removing the bottom infrared burner valve orifice extension:

1. Remove the grate and flavor grid above the bottom infrared burner.
2. Remove the burner.
3. Use a 3/4" wrench to hold the elbow and a pair of tongue and groove pliers to turn the extension counter clockwise.



Removing the bottom infrared burner valve orifice elbow:

1. Remove the grate and flavor grid above the bottom infrared burner.
2. Remove the burner.
3. Use (2) 3/4" wrenches, one to hold the elbow and one to turn the nut on the gas line.

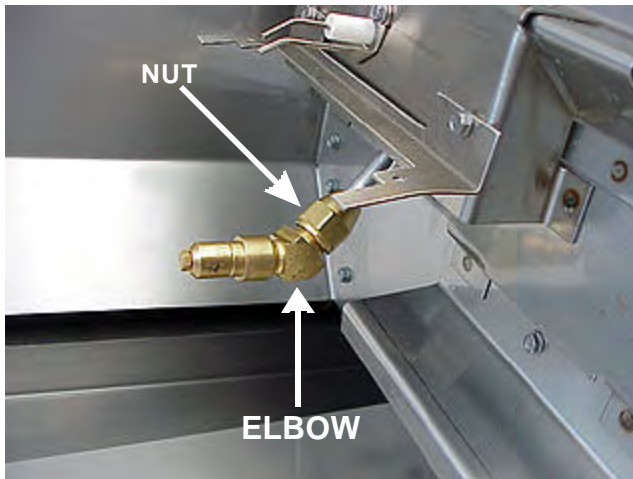

2. Remove the (6) screws holding the front upper heat shield to the lower shield. Two in the middle and two on each side.

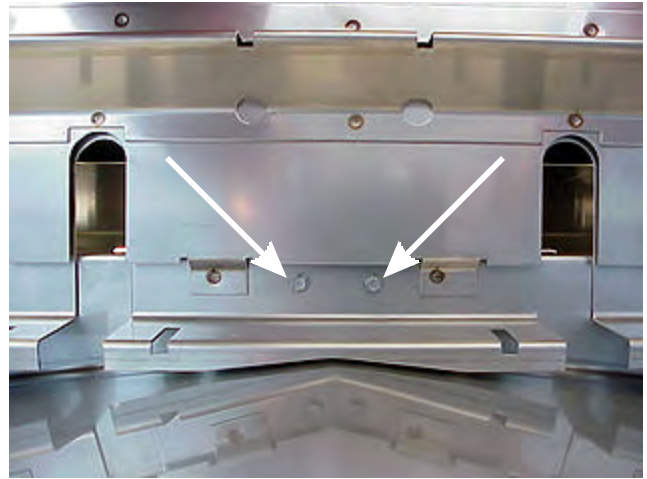

Removing the bottom flavor grids rear bracket: (44" and 51" models)

1. Remove the grates, flavor grid and main burners.
2. Remove the (4) screws holding the bracket to the bottom heat shield and lift the bracket off.

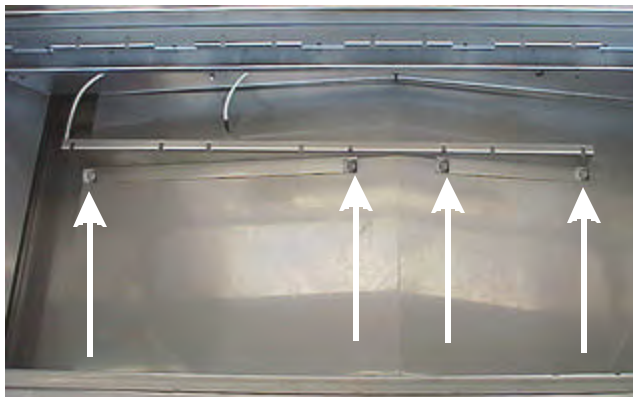

3. Remove the (8) screws holding the top of the upper heat shield to chassis.

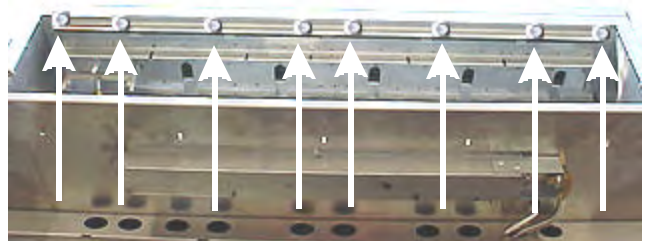

Removing the front upper heat shield: (44" and 51" models)

1. Remove the grates, flavor grid and the burners.

4. Remove the (3) screws at each end, holding the upper front heat shield to the chassis and lift the shield out.

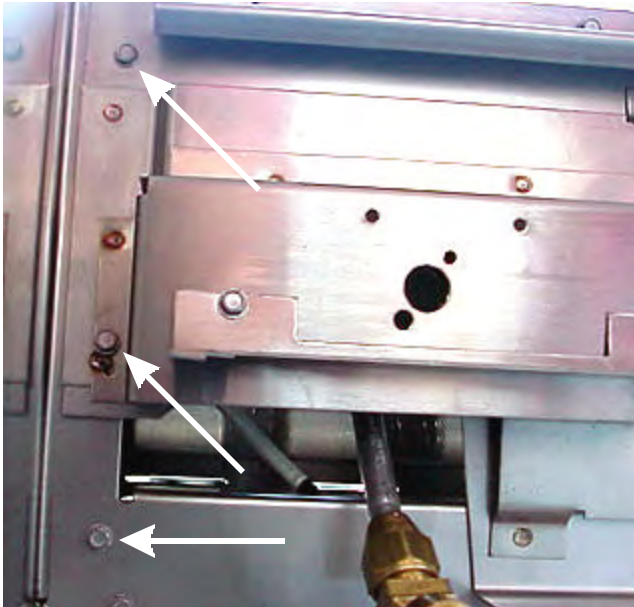

Removing the a main burner orifice: (44” and 51” models)

1. Turn the gas supply off, remove the burners and front upper heat shield.
2. Using a 3/8” socket remove the orifice from the valve.



Removing the a main burner orifice: (38” and smaller models)

1. Turn the gas supply off, remove the burners and front heat shield.

2. Using a 3/8” socket remove the orifice from the valve.



Removing the gas tube from the infrared burner valve:

1. Turn the gas supply off and remove the top front heat shield and the brass elbow.
2. Using a 3/4” wrench disconnect the gas tube from the valve.



Removing the lower front heat shield: (44” and 51” models)

1. Turn the gas supply off, remove the burners and top front heat shield.

2. Remove the (4) screws, two on each end, holding the front lower heat shield to the side heat shields.

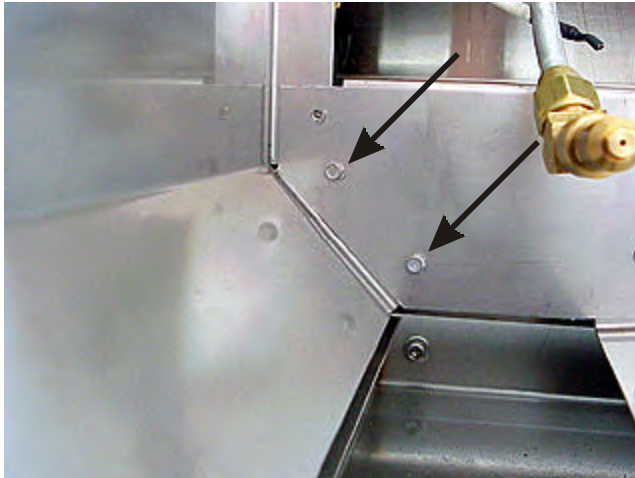

3. Remove the (6) screws, two in the middle and two on each side, holding the front lower heat shield to the bottom heat shield.

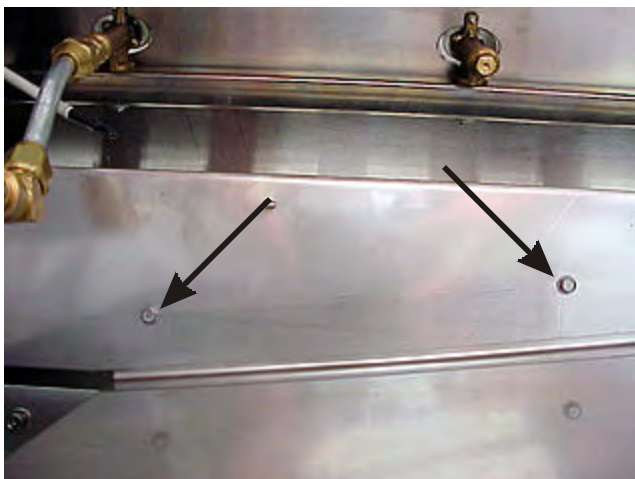
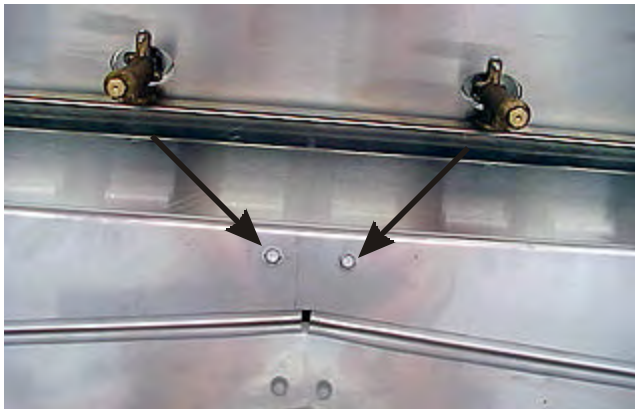

Removing the manifold: (Models built after September 2004)

1. Turn the gas supply off, remove the knobs, burners and front heat shield or shields.
2. Using a 3/4" wrench disconnect the incoming gas line from the manifold.



3. Using a 3/4" wrench the disconnect back burner gas line from the manifold.



- Remove the screws above the valve shafts that hold the bezels and the valves to the chassis.



- Using a 3/4" wrench the disconnect back burner gas line from the manifold.



- Pull the manifold back, push the manifold to the left, raise the left end of the manifold and lower the right end and swing the manifold out.

- Remove the screws above the valve shafts that hold the bezels and the valves to the chassis.

Removing the manifold: (Models built before October 2004)

- Turn the gas supply off, remove the knobs, burners and front shield or shields.
- Using a 3/4" wrench disconnect the incoming gas line and gas line to the side burner from the manifold.



- Pull the manifold back, push the manifold to the left, raise the left end of the manifold and lower the right end and swing the manifold out.

Removing the main burner valves:

- Turn the gas supply off and remove the manifold.

- Using a 1/4" socket remove the bolt from the bottom of the manifold holding the valve to the manifold and lift the valve off.



Note: There are washers on the bolt and valve, used to seal the valve and bolt to the manifold. When replacing either the bolt or the valve make sure the washers are in place.

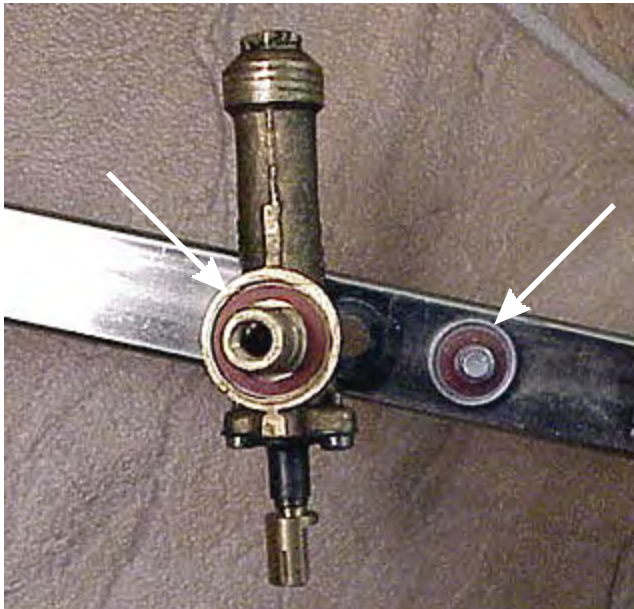

Removing the bottom heat shield: (44" and 51" models)

- Turn the gas supply off and remove grates, flavor grids, burners and top and bottom front heat shields.

- Remove the (6) screws holding the bottom heat shield to the rear heat shield. Two screws in the middle and two screws on each side.

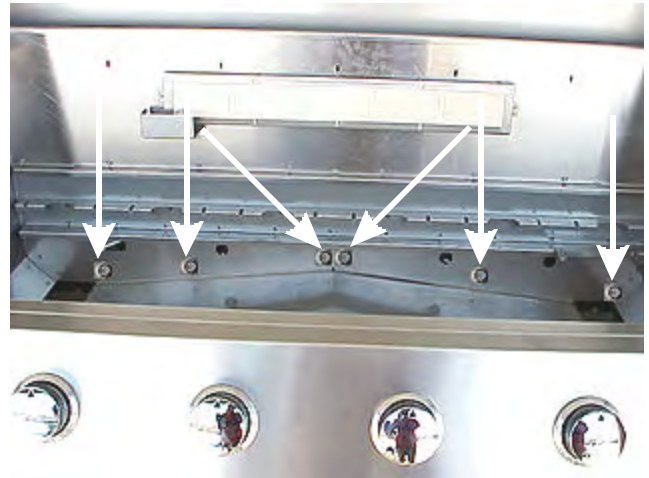

- Slide the shield to the left, raise the front of the shield to disengage it from the rear heat shield and pull forward.

Removing the bottom rear heat shield: (38" and smaller models)

- Turn the gas supply off and remove grates, flavor grids, front heat shield and burners.
- Remove the (4) screws holding the bottom rear heat shield to the backsplash.



Removing the bottom side heat shields: (38" and smaller models)

1. Turn the gas supply off and remove grates, flavor grids, front heat shield and burners.
2. Remove the (4) screws holding the bottom side heat shield to the back splash and front side heat shield.

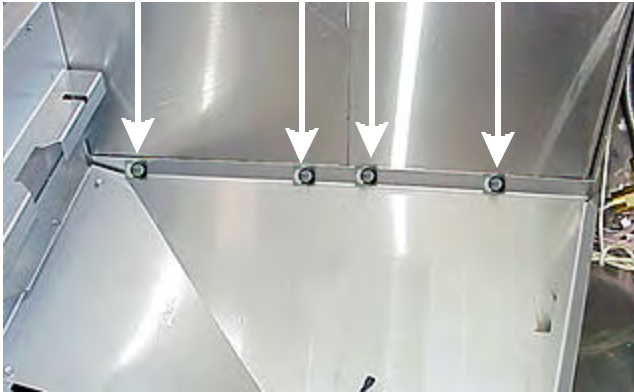

4. Remove all the screws holding the back splash to the chassis, except one in each front corner.

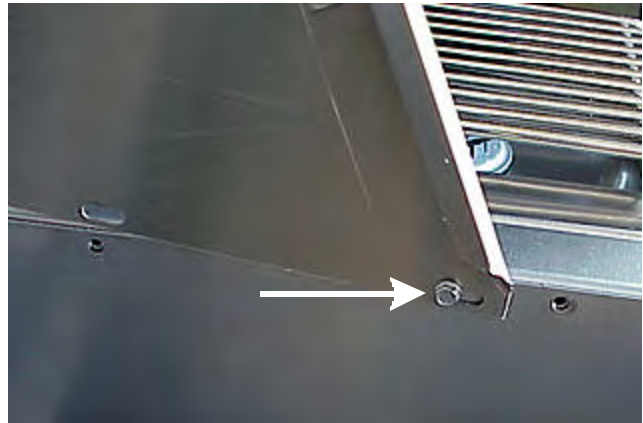

5. Loosen the (2) front screws about one turn, then raise the rear of the back splash and insert a board between the back splash and the chassis. This will allow access to the remaining screws holding the back heat shield to the chassis.



Removing the back heat shield: (44" and 51" models)

1. Turn the gas supply off and remove grates, flavor grids and burners.
2. Remove the roll top grill hood.
3. Remove the (6) screws holding the back heat shield to the bottom heat shield.

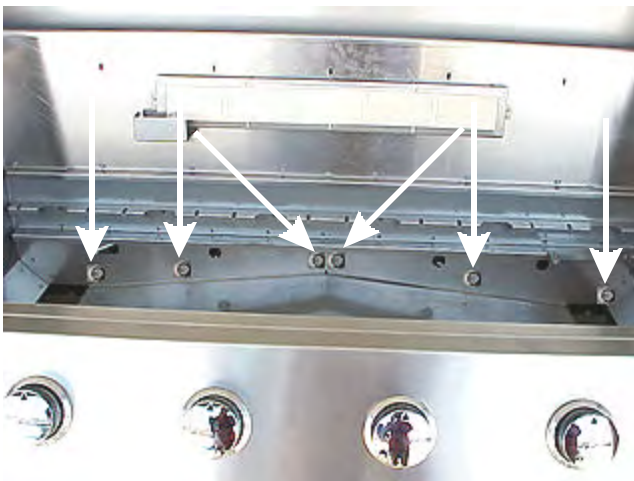

6. Remove the (8) screws, (4) at each end, holding the rear heat shield to the side heat shields.

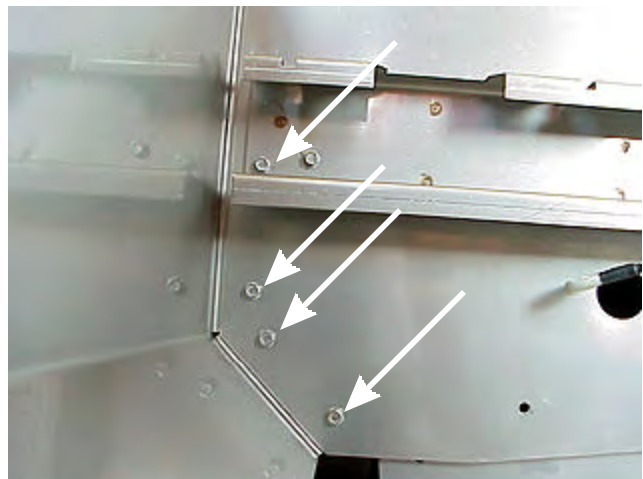

- Remove the (5) screws across the top holding the rear heat shield to the chassis and side heat shields.

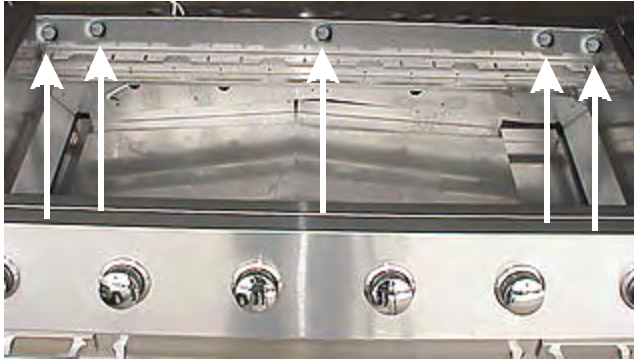

- Tip the bottom of the rear heat shield out and lift the heat shield up.

Removing the side heat shields: (44" and 51" models)

- Turn the gas supply off and remove the grates, flavor grids and burners.
- Remove the roll top grill hood, the back splash, the rear heat shield, top front heat shield and the bottom front heat shield.
- Remove the (3) remaining screws holding the top of side heat shield to the chassis and lift the side heat shield off.

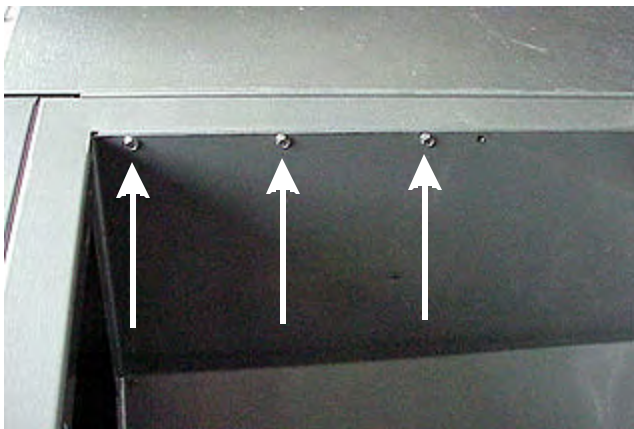

Removing the front side heat shields: (38" and smaller models)

- Turn the gas supply off and remove the grates, flavor grids front heat shield, burners and bottom side heat shield on that side.
- Remove the (3) remaining screws holding the shield to the chassis and lift the shield out.



Removing the gas line between base and manifold: (38" and smaller models)

- Turn the gas supply off and remove the grates, flavor grids front heat shield, burners and bottom side heat shield on that side.
- Using a 3/4" wrench disconnect the gas line from the base and manifold.

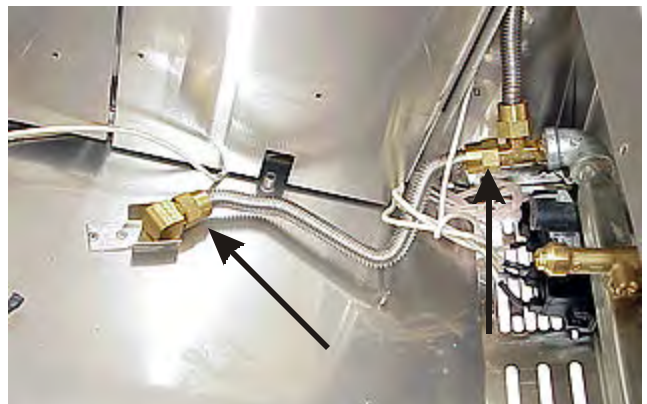

Removing the drip pans: (44" and 51" models)

1. Remove the drip pan by pulling it out.



Removing the drip pans: (38" and smaller models)

1. Open the door and remove the drip pan by pulling it out.



Removing the drip pan handle and faceplate: (44" and 51" models)

1. Using a 3/16" allen wrench remove the (2) screws holding the handle and face to the front of the drip pan.



Removing the warming drawer: (44" and 51" models)

1. Remove the warming drawer by pulling it out.

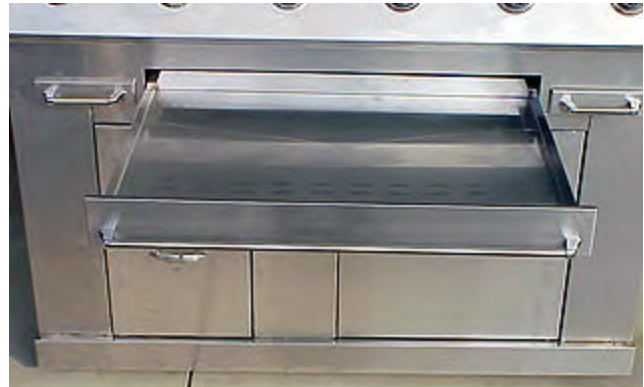

Removing the warming drawer handle and front plate: (44" and 51" models)

1. Using a 3/16" allen wrench remove the (2) screws holding the handle and front plate to the front of the warming drawer.



2. Then lift the door off the bottom hinge pin.



Removing the cart door handle: (44" and 51" models)

1. Open the door and remove the (2) phillips head screws holding the handle to the door.



Removing the cart door:

1. Release the top of the door, by reaching inside the cart and pushing down on the spring loaded top hinge pin.

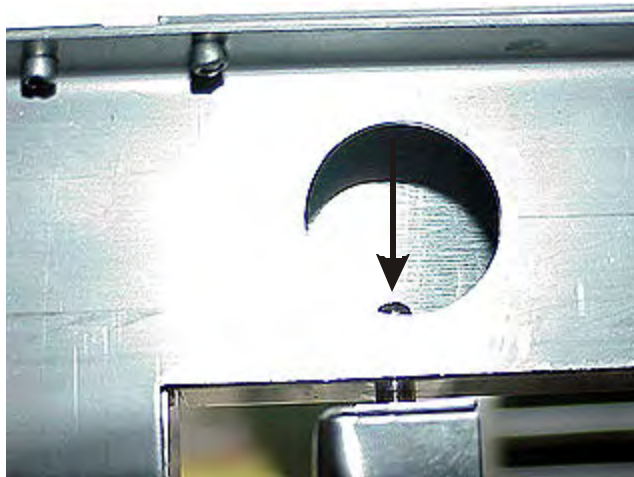

Removing the cart door handle end caps and handle: (38" and smaller models)

1. Open the door and using a 5/32 allen wrench remove the (2) screws holding the end caps to the door. The end caps slide off the handle.



Removing the cart door magnetic latch:

1. Open the door and remove the (2) screws holding the latch to the cart frame.



Removing the LP tank tray assembly: (44" and 51" models)

1. Open the door, remove the LP tank and pull the tray out to the stops.
2. Release the tray from the tracks by lifting up on the latch arm on the right and pushing down on the



Removing the LP tank tray assembly glides: (44" and 51" models)

1. Open the door and remove the LP tank tray assembly.

2. Remove the (3) screws holding the glide to the cart base.

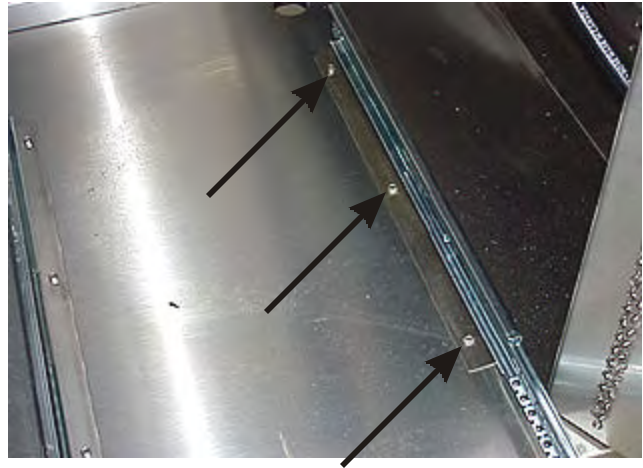

Removing the cart drawer assemblies: (44" and 51" models)

1. Pull the drawer assembly out to the stops.
2. Release the drawer assembly from the tracks by lifting up on the latch arm on the right and pushing down on the latch arm on the left.



Removing the cart drawer assembly handle: (44" and 51" models)

1. Open the drawer and remove the (2) phillips head screws holding the handle to the front of the drawer.

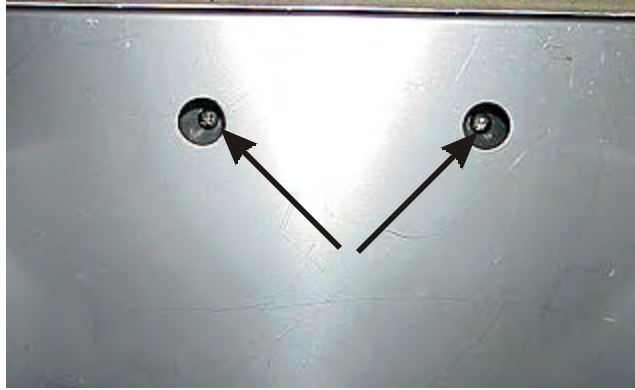

Removing the grill from the cart: (38" and smaller models)

1. Remove the door, on models manufactured after September 2004, disconnect the gas line from the side burner and pull it back into the cart.

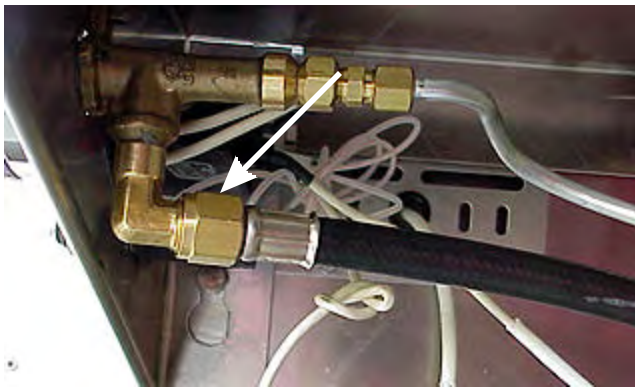

2. Disconnect the gas line to the manifold and remove the pressure regulator and hoses.



3. The grill is held to the cart by (4) 1/2" bolts, one in each corner, that drop into a key shape slot and (4) screws, two in the front and two in the rear. When the grill is set on the cart the bolt head drop through the larger opening. The grill is then slide back and the bolt tighten and the screws installed.

Note: When removing the grill it is not necessary to remove the bolts only loosen them.

4. Remove the (4) screws.



Loosen the (4) bolts, slide the grill forward and lift it off.

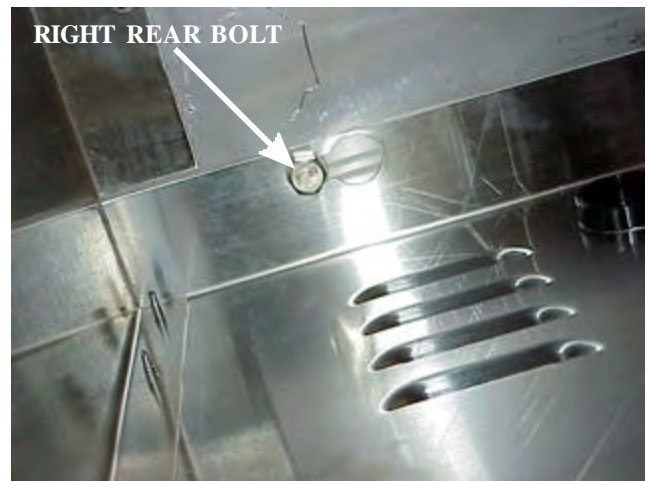

Note: Set the grill on two-by-fours to prevent damage to the manifold gas connection.

Removing the grill from the cart: (44" and 51" models)

1. On models manufactured after September 2004, disconnect the gas line from the side burner and pull it back into the cart.

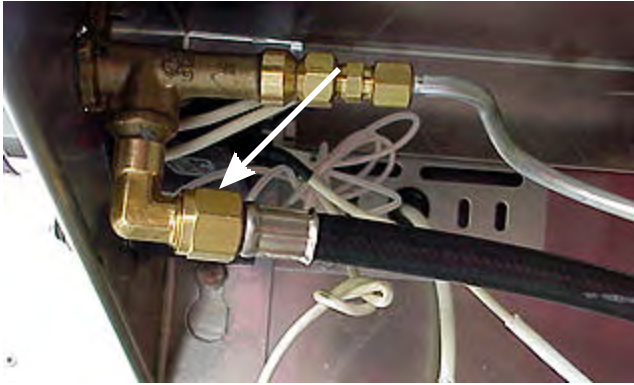

2. Disconnect the gas line to the manifold and remove the pressure regulator and hoses.

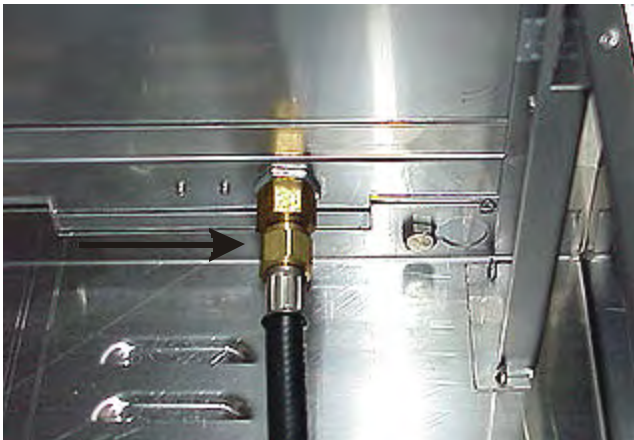

3. The grill is held to the cart by (4) 1/2" bolts, one in each corner, that drop into a key shape slot. When the grill is set on the cart the bolt head drop through the larger opening. The grill is then slide back and the bolt tighten.

Note: When removing the grill it is not necessary to remove the bolts only loosen them.

4. To loosen the (2) bolts on the right side, open the cart door and uses a 1/2" socket loosen the one in the front and the one in the rear.

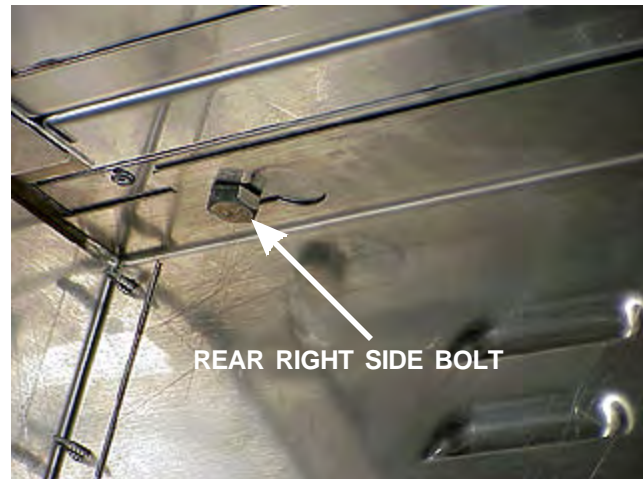

5. To loosen the (2) bolts on the left side, remove the (2) left side main grates and the left side top and bottom flavor grids.

6. Remove the left side drip tray and going in from the top use a 1/2" socket to loosen the (2) left side bolts.



7. Slide the grill forward to disengage the bolts and lift the grill off the cart.

Note: Set the grill on two-by-fours to prevent damage to the manifold gas connection.

Removing the wheel channels: (38" and smaller models)

Note: Each pair of wheels are welded to a channel that is held to the base by (4) bolts.



1. Raise the cart and place two-by-four under it so that the wheels are off the ground.
2. From inside the cart remove the (4) bolt holding wheel channel to the base.

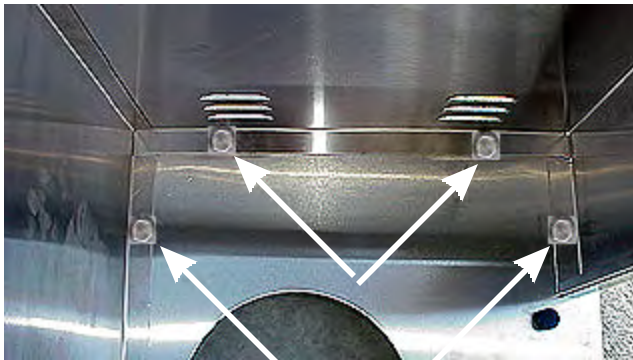

Removing the wheel channels: (44" and 51" models)

Note: Each pair of wheels are welded to a channel that is held to the base by (4) bolts.



Note: If removing the left wheel channel the grill must be removed from the cart.

1. Raise the cart and place two-by-four under it so that the wheels are off the ground.
2. From inside the cart remove the (3) nuts and 1 bolt holding wheel channel to the base.

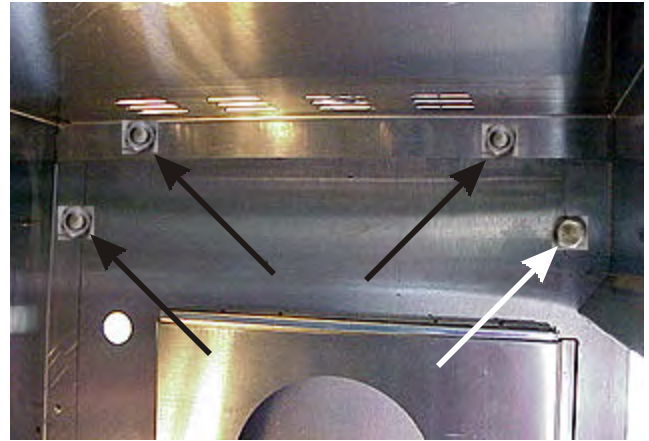

Removing the cart's rear panel: (38" and smaller models)

1. Remove the grill.
2. Remove the (4) screws, two on each end, holding the rear panel to the side panel.

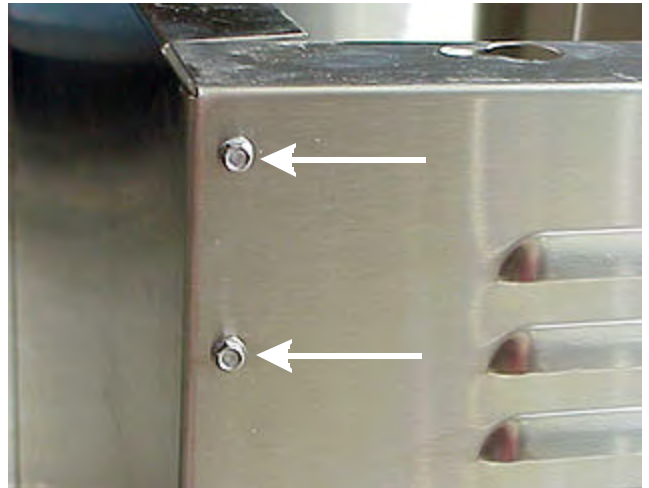

3. Remove the (2) bolts holding the rear panel to the base and lift the rear panel off.

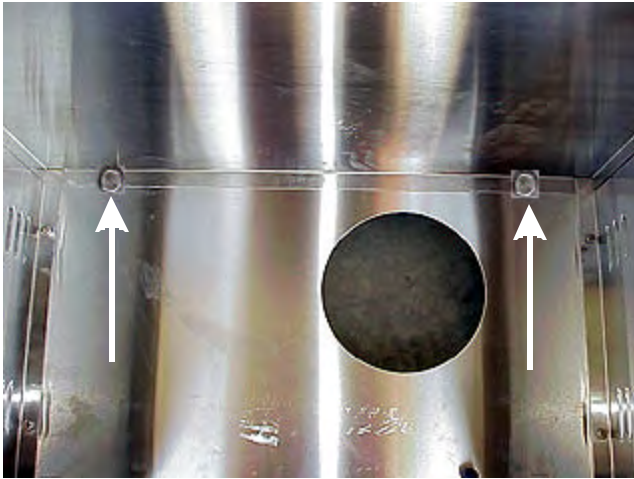

Removing the cart's side panels: (38" and smaller models)

1. Remove the grill from the cart.
2. Remove the (2) screws holding the rear panel to the side panel.

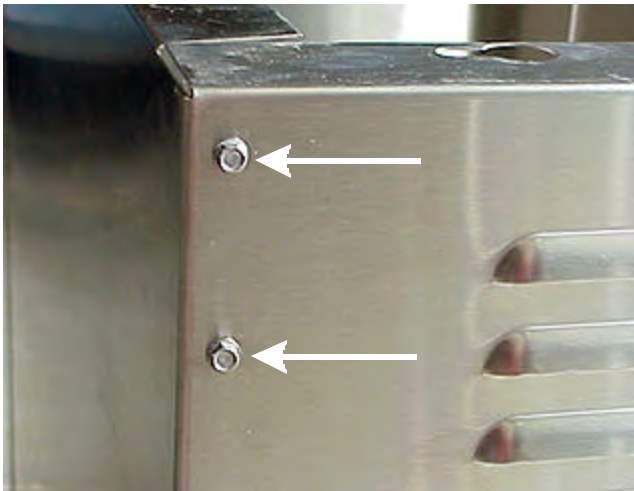

3. Remove the (3) bolts holding the side panels to the base.

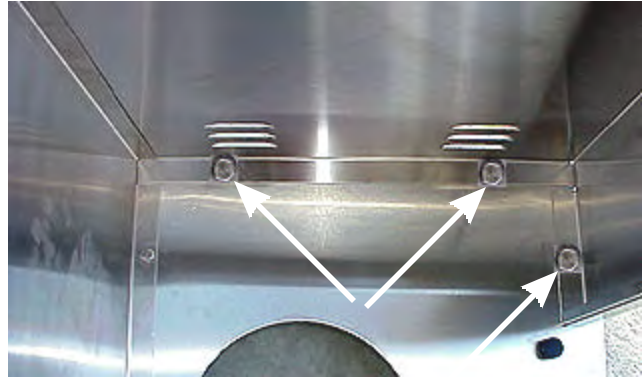

Removing the drawer housing top: (44" and 51" models)

1. Remove the grill from the cart.
2. Remove the (6) screws holding the top to the sides of the housing.

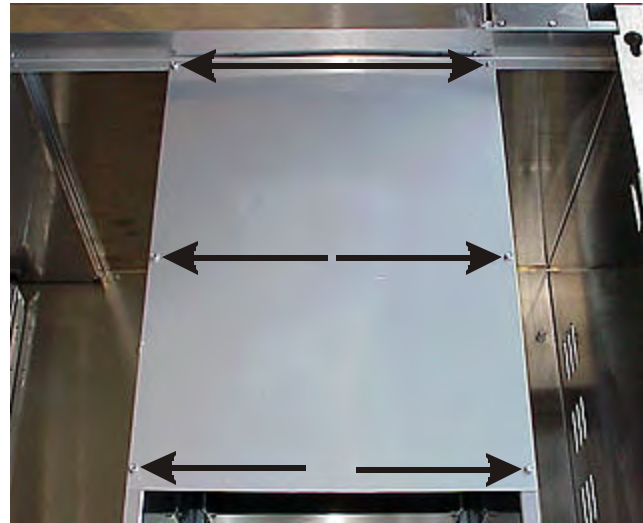

Removing the drawer housing sides: (44" and 51" models)

1. Remove the grill and drawers from the cart.
2. Remove the (3) screws holding the top to the side of the housing.

3. Remove the (3) screws holding the side to the base.

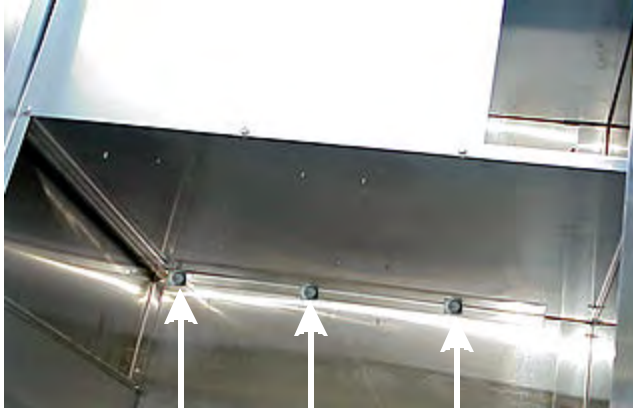

4. Remove the (2) screws holding the side housing to the rear panel and slide side housing out.

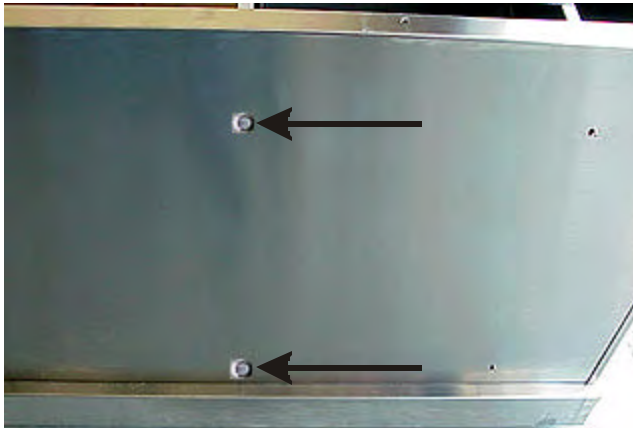

Removing the cart's rear panel: (44" and 51" models)

1. Remove the grill and drawers from the cart.
2. Remove the top and sides of the drawer housing.

3. Remove the (4) screws, two on each end, holding the rear panel to the side panel.

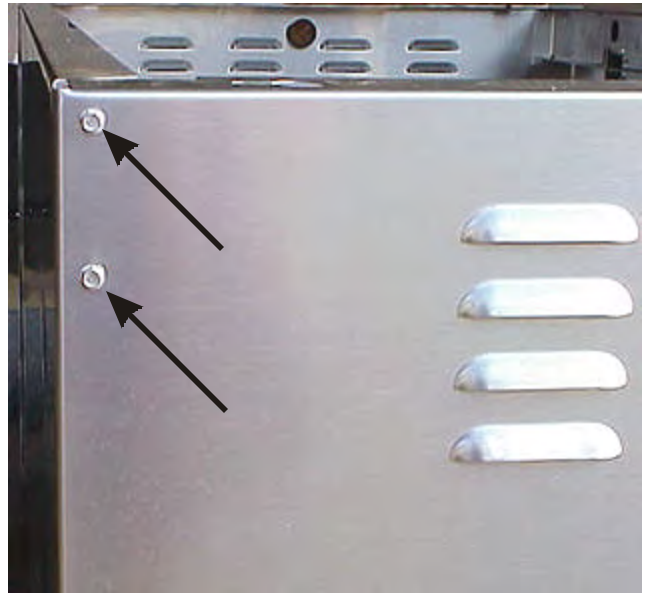

4. Remove the (2) nuts and (2) screws holding the rear panel to the base and lift the rear panel off.

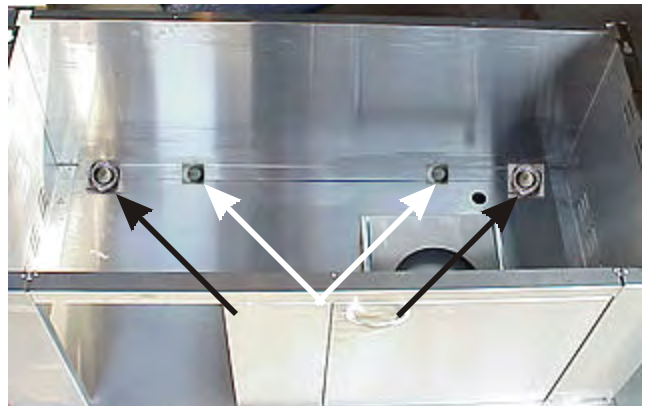

Removing the cart's front center panel: (44" and 51" models)

1. Open the door and remove the (2) screws holding top of the front center panel to the front brace.

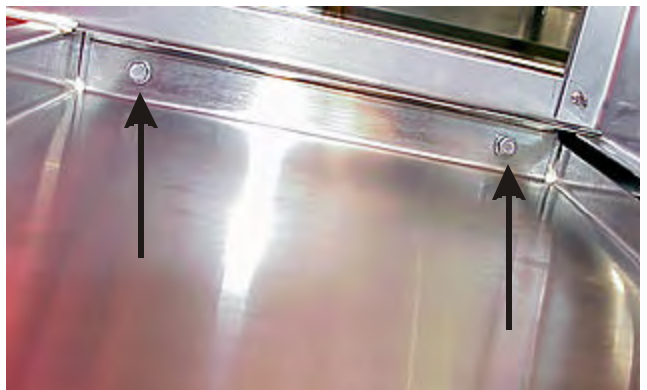

2. Remove the (2) bottom screws holding center front panel to the base and pull the panel out the front.

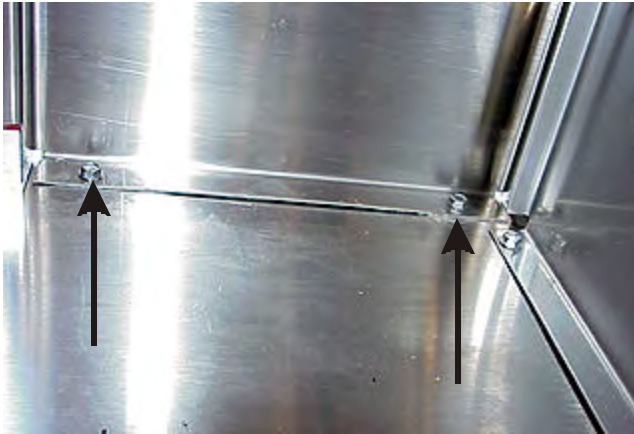

3. Remove the (2) screws holding the side panel to the front brace.

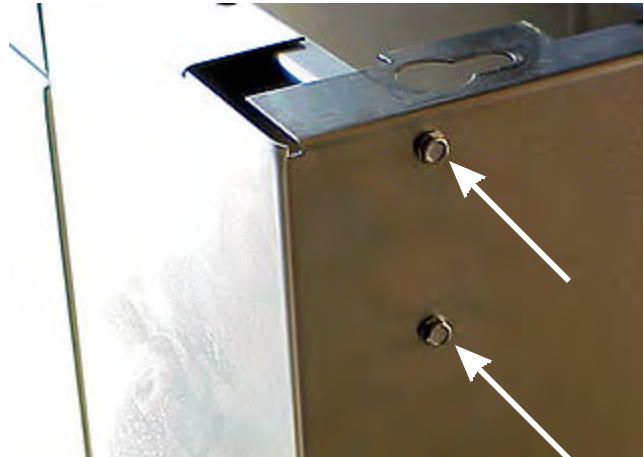

Removing the cart's side panels: (44" and 51" models)

1. Remove the grill, drawers and door from the cart.
2. Remove the (2) screws holding the rear panel to the side panel.

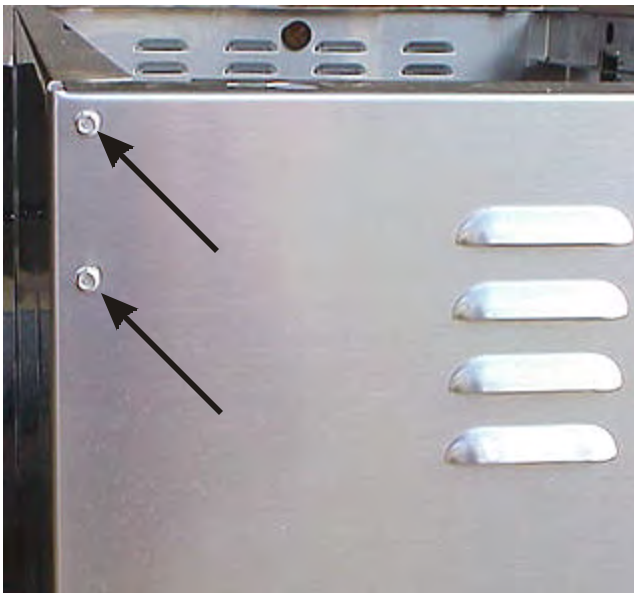

4. Drill out the (2) pop rivets holding the side panel to the front brace.

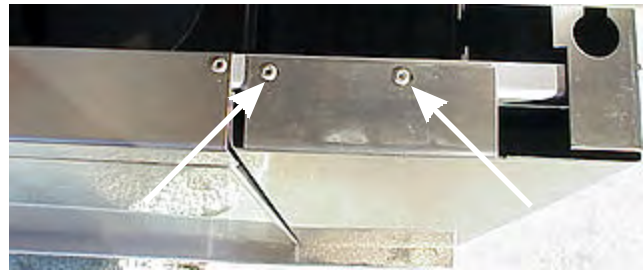

5. Remove the (2) bolts, one on each end, holding the front panel to the base.



6. Remove the bolt holding front wing of the panel to the base and remove the side panel.

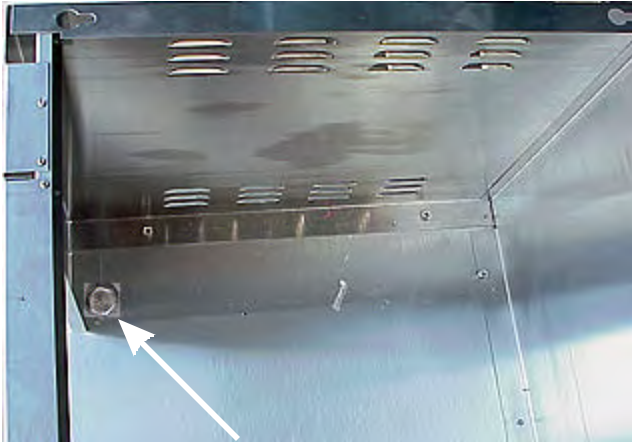

Removing the cart's front brace: (44" and 51" models)

1. Remove the grill, drawers, door and front center panel from the cart.
2. Remove the (4) screws, (2) on each end, holding the brace to the side panels.

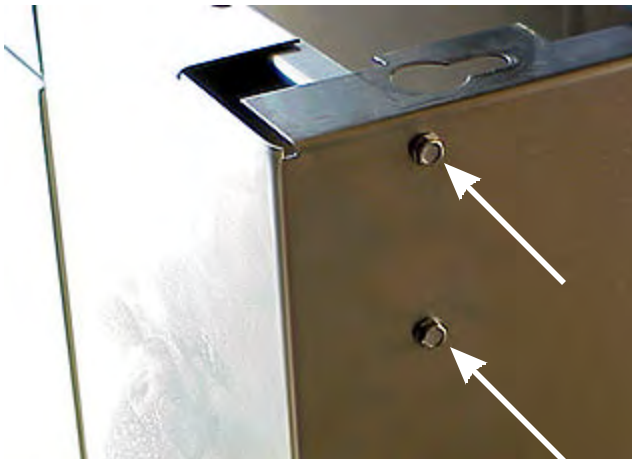

3. Drill out the (4) pop rivets, (2) on each end, holding the bar to the side panels and lift the bar out.

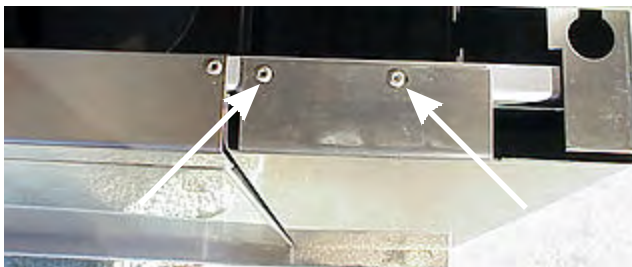

SECTION F - TEARDOWN MODELS WITH SERIAL NUMBER STARTING WITH THE LETTER "D"

This section will describe how to remove components from grill. Unless stated, the procedure will be the same on all grills. Unless stated, reverse the procedure to reinstall the component.

⚠ WARNING Always remove electrical power from the grill when working in an area where electrical power is present.

⚠ WARNING Always turn the gas off to the grill before opening any gas piping.

Note: All components may not be on all models.

Note: Screws used on this model can be removed by either a common or phillips screwdriver

Note: All screws used in the grills are stainless steel. To prevent rust use only stain steel screws when for replacing.

Removing the temperature gauge:

1. Raise the grill hood, using a 5/32" socket remove the (2) nuts holding gauge to hood and lift the gauge out.



Removing the roll top grill hood handle assembly:

1. Raise the roll top grill hood and remove the (2) screws holding the handle posts to the hood and lift the handle assembly off.



Removing the roll top grill hood handle post from the handle:

1. Remove the handle assembly and remove the screw holding the post to the handle.

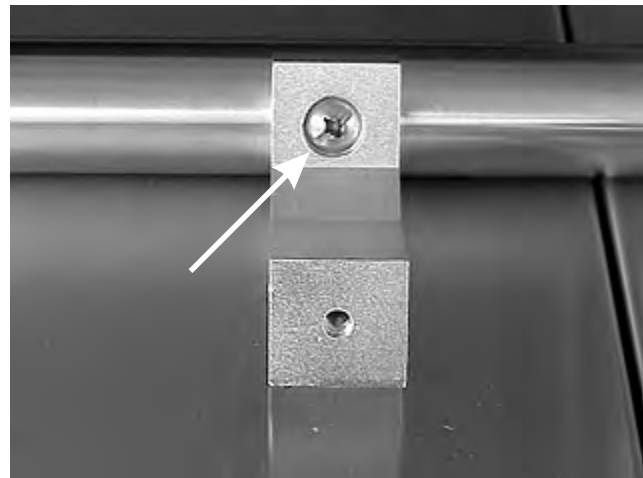

Removing the roll top grill hood:

1. The roll top grill hood is held to the back splash on each end by a bolt with a common screwdriver slot and a 10 mm nut. The hood is spaced away from the back splash by spacer welded the hood.

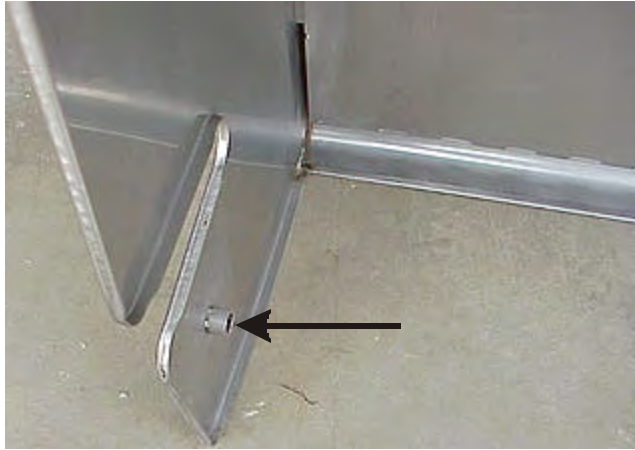

2. The hole in the back splash is threaded, the bolt is screwed through the back splash and lock in place with the 10 mm nut.



3. To remove the roll top grill hood, raise the grill hood and remove the 10 mm nut from each end.



2. Using a common screwdriver remove the bolt from each end.



Removing the side drawer:

1. Pull the drawer assembly out to the stops.
2. Release the drawer assembly from the tracks by lifting up on the latch arm on the left and pushing down on the latch arm on the right.



Removing the side drawer handle:

1. Open the drawer and remove the (2) screws holding the handle to the face of the drawer.

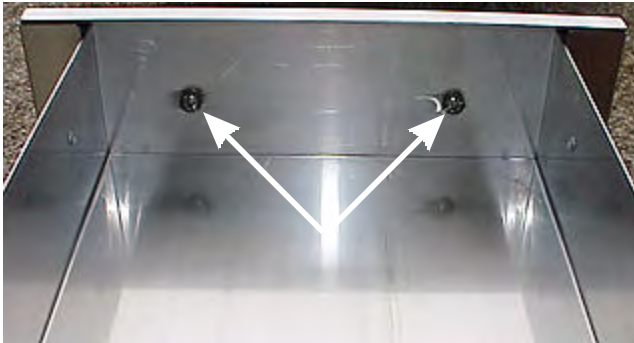

Removing the side drawer shelf:

1. Remove the drawer.
2. Remove the (4) screws, (2) in the front and (2) in the rear, and lift the shelf off.

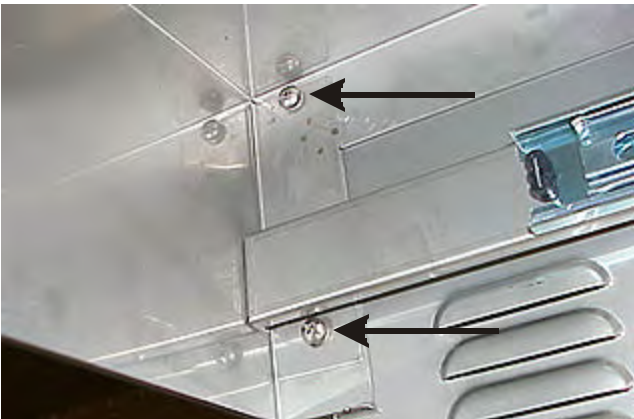

Removing the knobs:

Note: A 2 mm allen wrench is supplied with the grill.

1. The knob has a D shaped shaft and is lock to the valve stem by a 2 mm allen set screw. The screw is accessed through a hole in the bottom of the knob.

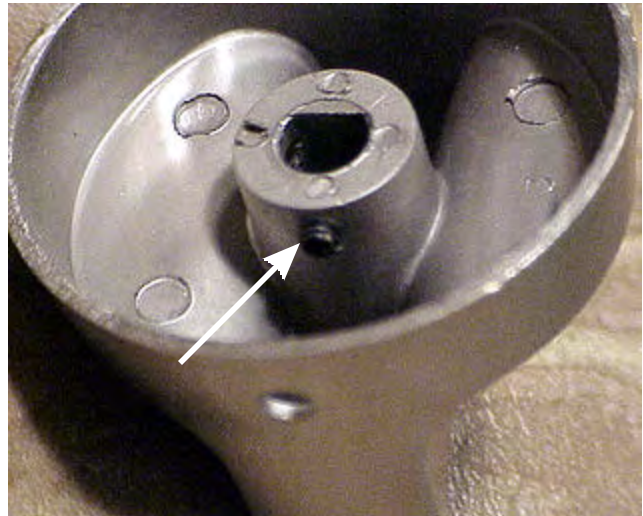

2. To remove the knob, insert a 2 mm allen wrench through the hole in the bottom of the knob, loosen the set screw and pull the knob off.



Removing knob bezel:

1. Remove the knob.

2. Remove the (2) screw holding the bezel to the valve and chassis and lift the bezel off.



Removing the batteries for the main burners and side burner:

Note: The main burner igniter battery is size AA while the side burner igniter battery is size AAA

1. Turn the front cap of the battery housing counter clockwise, remove the cap and spring, and pull the battery out.



Removing the infrared burner and igniter shield:

1. Raise the roll top hood, remove the (3) screws holding the shield to the backsplash and lift the shield off.

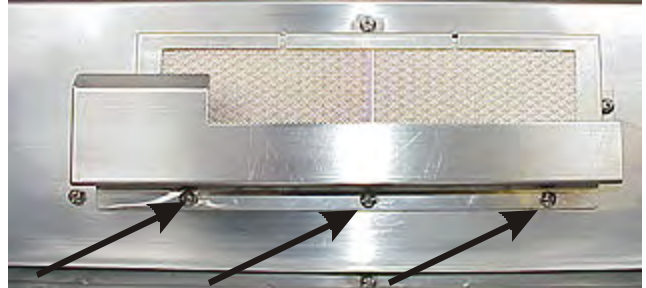

Removing the infrared burner rear heat shield:

1. Raise the roll top hood and remove the (3) screws holding the heat shield to the backsplash.



2. From the rear of the grill, lift the heat shield tabs out of the slots in the chassis.



Removing the infrared burner spud:

1. Remove the infrared burner's rear heat shield.

- Using a 10 mm wrench turn the spud counter clockwise.



Removing the infrared burner orifice assembly:

- Remove the infrared burner rear heat shield.
- Using a 10 mm wrench disconnect gas line from the orifice assembly.

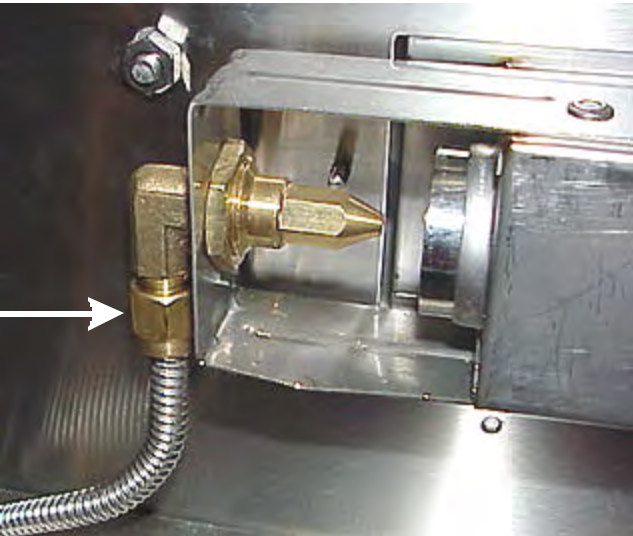

- Using a 15/16" wrench remove the large nut locking the orifice assembly to the infrared burner bracket and slide the orifice assembly out.

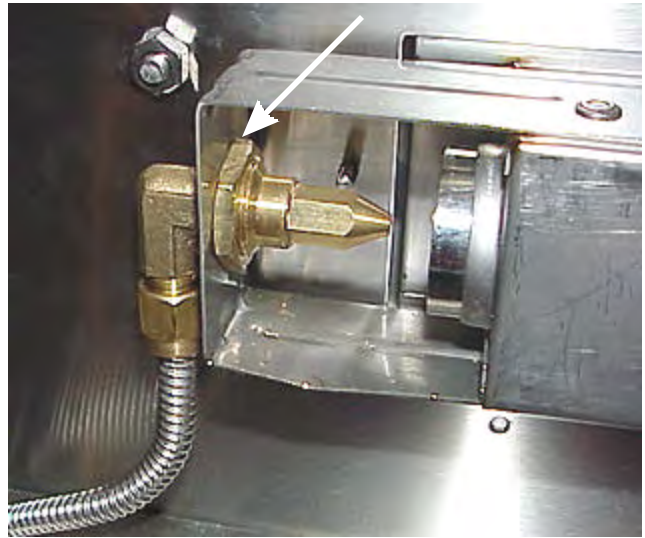

Removing the back infrared burner:

- Remove the back infrared burner rear heat shield.
- Using a 15/16" wrench remove the large nut locking the orifice assembly to the bracket.
- Raise the roll top hood and remove infrared burner igniter shield.
- Remove the (1) screw holding the igniter to the back splash and pull the igniter into the grill burner box.



5. Remove the (2) screw, (1) at each end, holding the infrared burner to the backsplash.



6. Pull out on the left end of the burner, slide the burner to the left and out.

Removing the side burner cover:

1. Raise the cover, using a 5 mm allen wrench remove the (2) screws, (1) in each rear corner, and lift the cover off .



Removing the side burner grate:

1. Raise the cover and lift the grate off.



Removing the side burner head:

1. Raise the cover, remove the grate and lift the side burner head off.



Removing the side burner ring:

1. Raise the cover, remove the grate and lift the side burner ring off.



Removing the side burner body:

1. Raise the cover, remove the grate, burner head, burner ring and lift the side burner body off.



2. Using a 14 mm wrench, disconnect the gas line from the side burner orifice base.

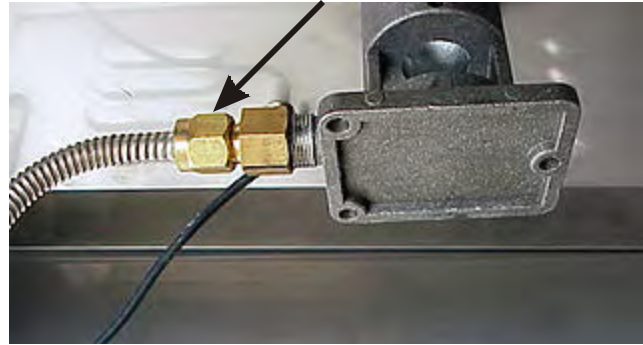

3. Using a 1 1/2" wrench or socket, remove the nut holding the orifice base to the side burner bowl assembly.



Removing the side burner orifice:

1. Raise the cover, remove the grate, burner head, burner ring and side burner body.
2. Using a 7 mm socket turn the orifice counter clockwise to remove.



Removing the side burner control panel:

1. Remove the side burner knob and bezel.
2. Remove the side burner igniter battery cap and battery.
3. Remove the locking nut holding the battery holder spark module combination to the side burner control panel.



Removing the side burner orifice base:

1. Raise the cover, remove the grate, burner head, burner ring and side burner body.

4. Remove the (4) screws, (2 on each end, that hold the side burner control panel to the side burner bowl assembly.

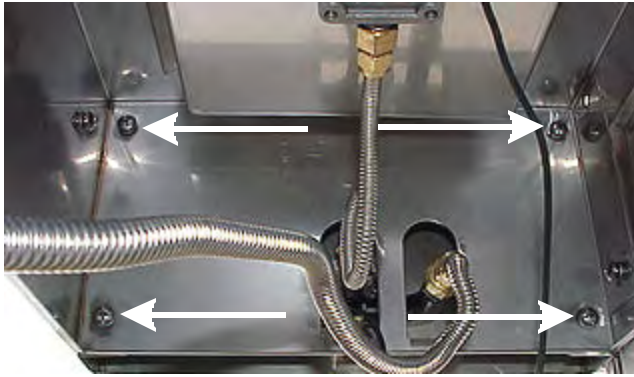

Removing the side burner igniter:

1. Raise the cover, remove the grate, burner head, burner ring and side burner body.
2. Remove the side burner control panel and unplug the igniter wire from the module.

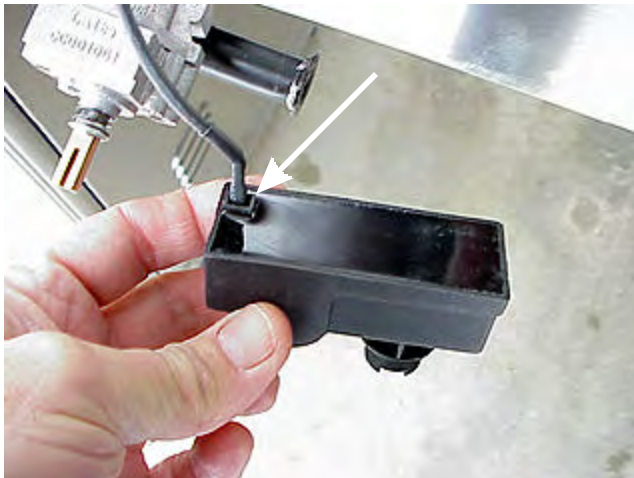

3. Remove the (1) screw holding the igniter to the side burner bowl assembly and lift the igniter and wire out.



Removing the side burner igniter module battery holder combination:

1. Remove the side burner control panel and unplug the igniter wire from the module.

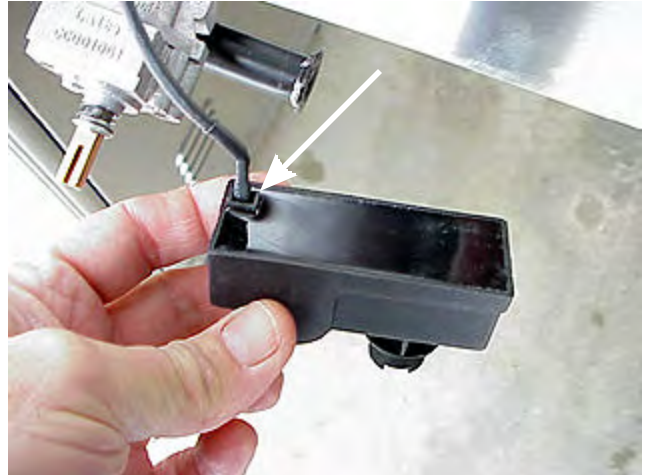

Removing the side burner valve:

1. Turn the gas off and remove the side burner control panel.
2. Using a 14 mm wrench disconnect the gas line from the output side of the valve.



- Using a 10 mm socket remove the clamp holding the valve to the side burner manifold and lift the valve off.



Removing the side burner manifold:

- Turn the gas off, remove the side burner control panel and side burner valve.
- Using a 14 mm wrench disconnect the gas line from the manifold.



Removing the side burner push bar:

- Remove the (2) screws holding the handle to the side burner bowl assembly

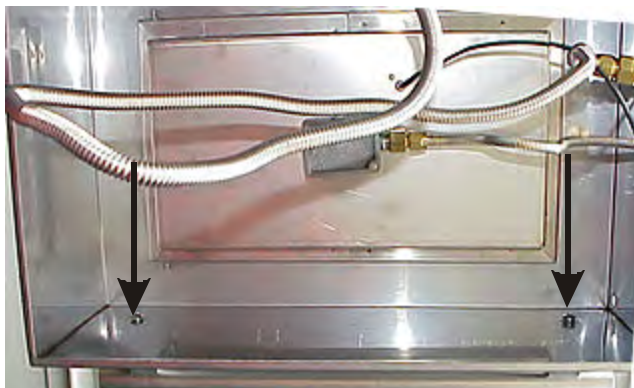

Removing the side burner assembly:

- Turn the gas off and disconnect the input gas line to the side burner manifold.
- Remove the (4) screws, (2) in the front and (2) in the rear, holding the side burner assembly to the side of the grill and lift the assembly off.

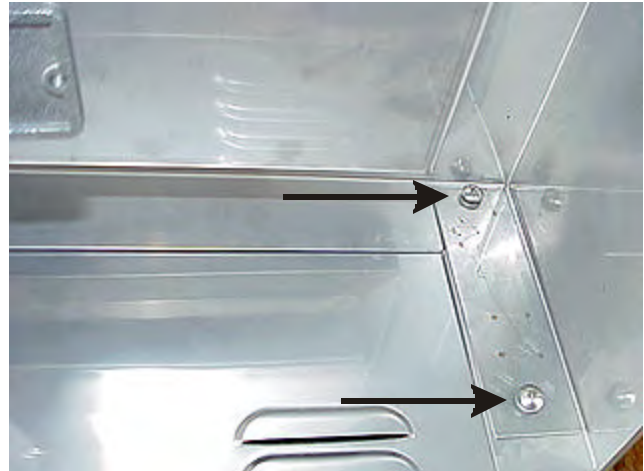

Removing the main grates:

- Raise the roll top hood and lift the grates out.



Removing the top flavor grids:

- Raise the roll top hood and remove the grates.

- Lift the top flavor grids out.



Removing the bottom flavor grids:

- Raise the roll top hood, remove the grates and top flavor grids.
- Lift the bottom flavor grids out between the burners.



Removing the main control panel:

- Disconnect the gas, remove the drawer assembly, the main burner knobs and rotisserie burner knob.
- Remove the main burner battery cap and battery.
- Remove the locking holding the main burner battery holder and spark module combination to the main control panel.
- Remove the side burner control panel.

- Remove the (4) screws, (2) on each end, and lift the main control panel off.

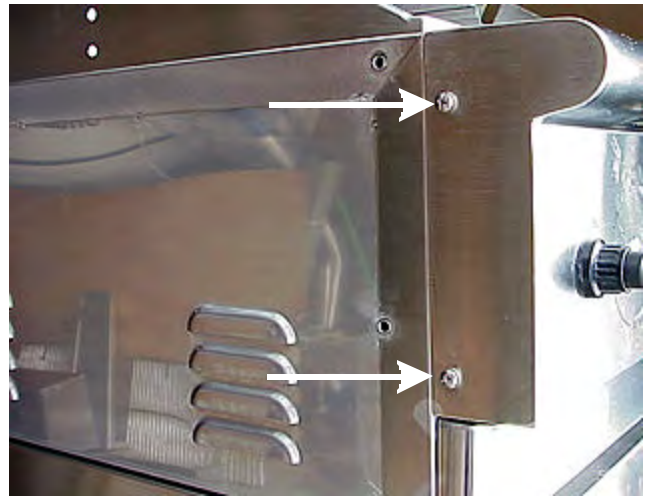

Removing the main combination battery holder and spark module combination:

- Disconnect the gas and remove the main control panel.
- Disconnect the wires from the module.



Removing the main burners:

- Disconnect the gas, remove the main control panel and allow the manifold pipe to move forward disengaging the valves from the burners.

- Loosen the (2) screws holding the burner to the rear wall of the grill burner box and lift the rear of the burner up and out.

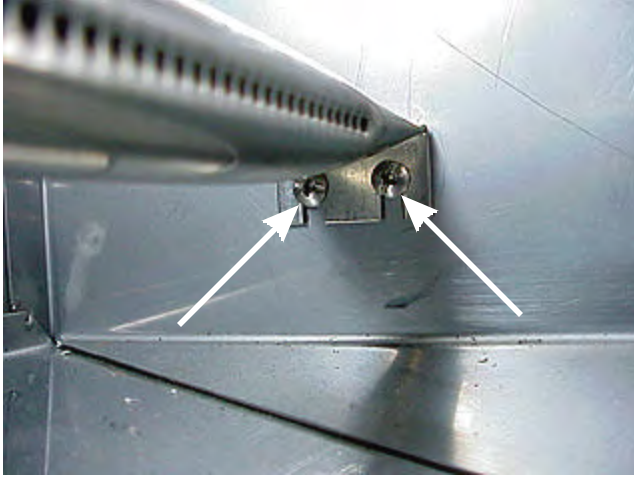

Removing the main valves and manifold pipe assembly:

- Disconnect the gas and remove the main control panel.
- Using a 14 mm wrench disconnect the gas line from the infrared burner valve.

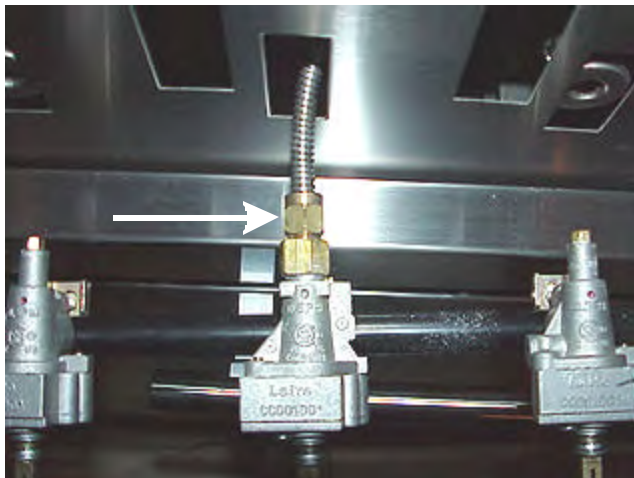

- Using a 16 mm wrench disconnect the gas line from the end of the manifold pipe and lift the manifold and valve assembly out.

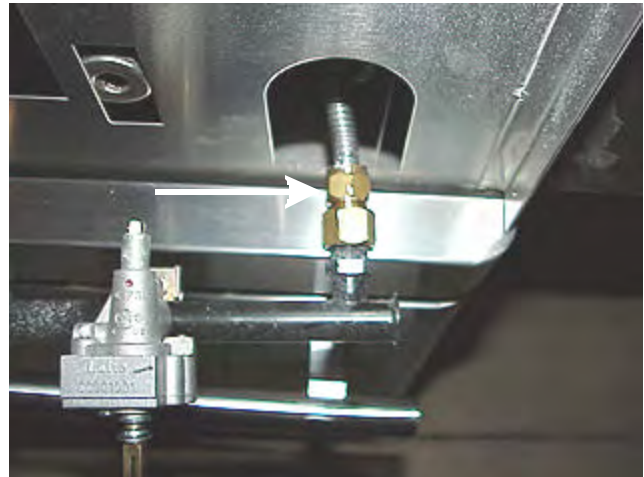

Removing the main burner orifices:

- Disconnect the gas, remove the main control panel.
- Using a 6 mm socket turn the orifice counter clockwise to remove.

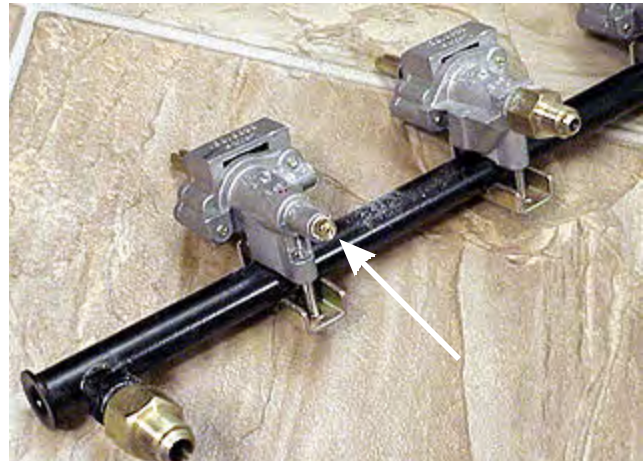

Removing the main burner valves:

- Disconnect the gas, remove the main control panel.

- Using a 8 mm socket remove the screw holding the bracket that lock the valve to the manifold and lift the valve off.

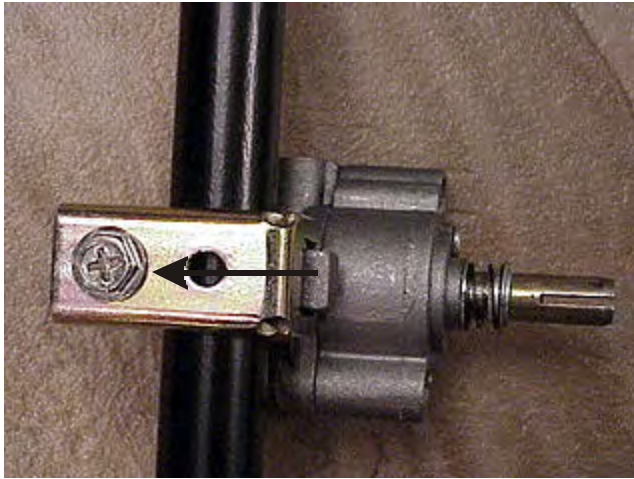

- When reinstalling be sure the gasket is in place.



- The burner box is held to the grill chassis by (9) screws. (3) on each end

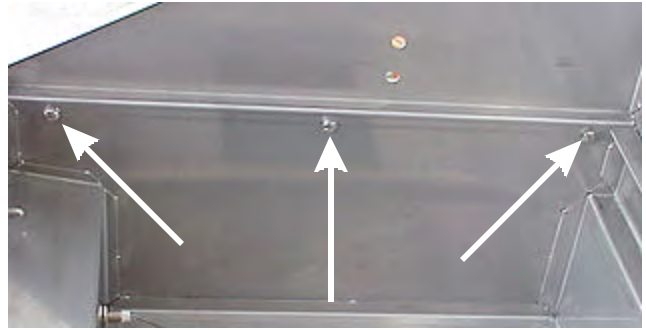

and (3) across the back.

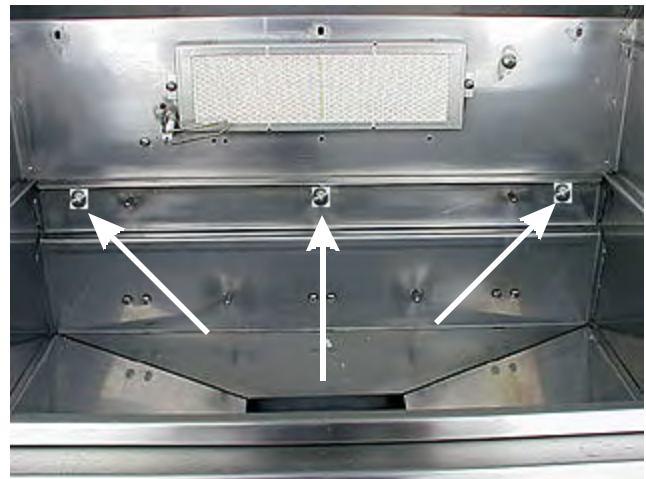

- Lift the burner box out of the chassis.



Removing the burner box:

- Disconnect the gas, remove the roll top hood and main control panel.
- Disconnected the gas line from the infrared burner, the wires from the main spark module and pull the wire to the infrared burner igniter out the back.
- Remove the (3) main burners.

Removing the infrared burner igniter:

1. Turn the gas off and remove the burner box.
2. Remove the (1) screw holding the igniter to the burner box and pull the igniter and igniter wire out.



Removing the main burner igniters:

1. Turn the gas off, remove the burner box and note the direction the tip of the igniter is pointing.
2. Using (2) 14 mm wrenches, one to hold the locking nut



the other to remove the nut holding the igniter to the burner box.

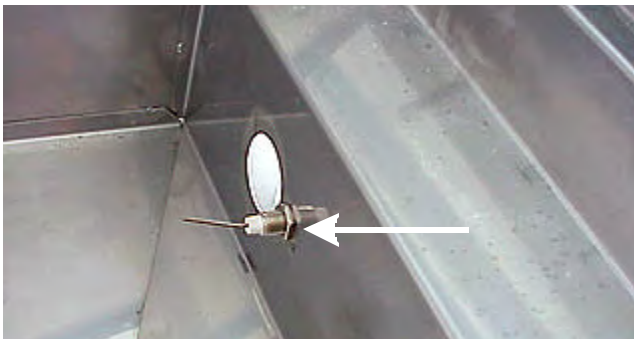

3. Remove the nut inside the burner box and pull the igniter out.

Note: When installing a main burner igniter make sure the tip point to the burner before locking it in place.

Removing the small manifold that spilt the incoming gas:

1. Turn the gas off and remove the burner box.
2. From inside the cart disconnect the pressure regulator hose and remove the nut locking the manifold to the chassis of the grill.



3. From inside the chassis disconnected the gas line to the main manifold and the gas line to the side burner.

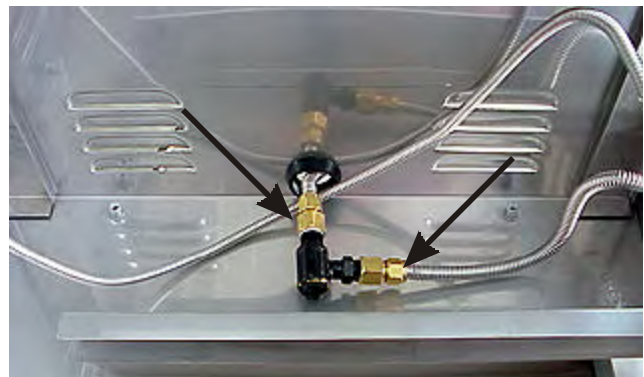

4. Lift the small manifold out.

Removing the grease tray:

1. The grease tray is removed by pulling it out.



Removing the grill from the cart:

1. Turn the gas off and disconnect the pressure regulator hose from the bottom of the grill.
2. The grill is held to the cart by (4) large head screws that go through key slots in the flange of the side panel of the cart



and (2) screw through the flange of the rear panel of the cart.



3. Remove the (2) screws from the rear panel, Loosen the (4) screws, (2) on each side, slide the grill to the rear and lift it off the cart.

Removing the towel rack:

1. Open the left door and remove the (4) screws holding the towel rack bracket to the inner liner of the door.

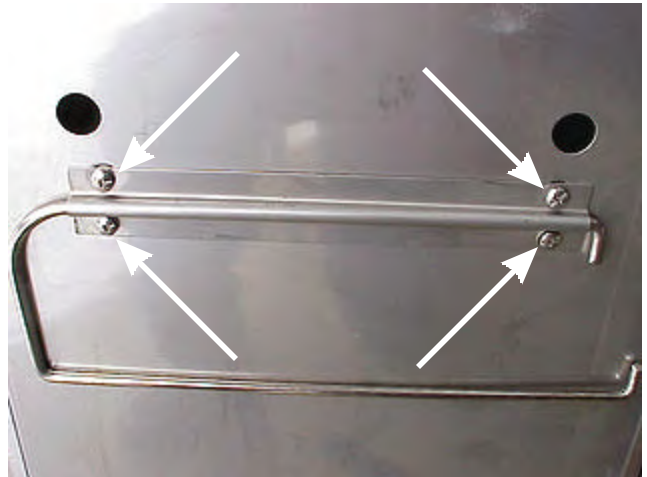

Removing the door handle:

1. Open the door and remove the (2) screws holding the handle to the outer liner of the door.



Removing the cylinder holder:

1. Open the doors, remove the gas cylinder and pull the cylinder holder out until it hit the stops.
2. Release the cylinder holder from the tracks by lifting up on the latch arm on the left and pushing down on the latch arm on the right.



2. Using a phillips screwdriver and a 7 mm socket remove the (2) bolts and nuts holding the tracks to the side rails.



Removing the cylinder holder side rails:

1. Open the doors and remove the cylinder holder.
2. Remove the (2) screws holding the rail to the base.

Removing the cylinder holder locking bolt:

1. Open the doors and turn the wing nut on the locking bolt counter clockwise.

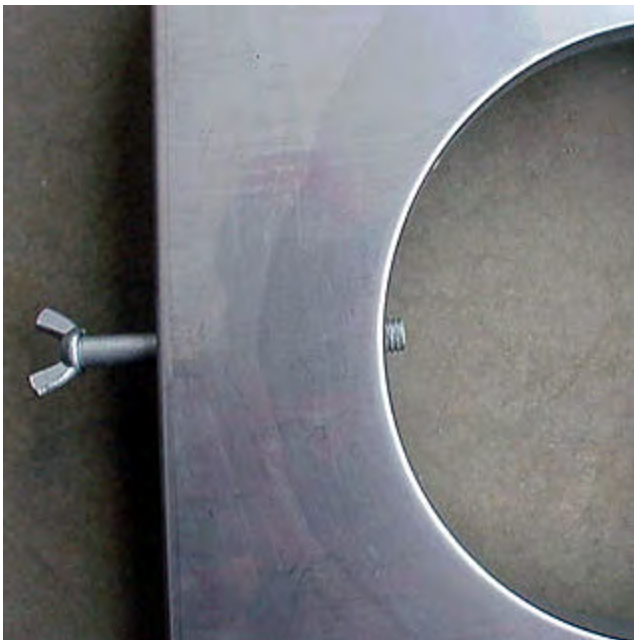

Removing the cylinder holder side tracks:

1. Open the doors remove the cylinder holder and push the tracks back in.

Removing the doors:

1. For the lefthand door remove the drawer assembly and the grease tray. For the right hand door remove the side burner control panel and the grease tray.

2. The door is held to the hinges by a rod that run the between the top and bottom hinge inside the door.



2. Remove the (2) screws holding the hinge to the cart frame and pull the hinge out.



3. The rod is held in place by a clip below the bottom hinge.

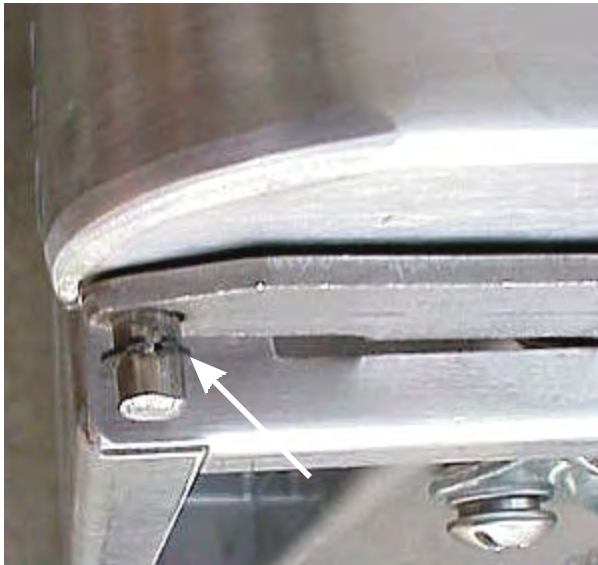

Removing the door magnet:

1. Remove the grease tray.
2. Using a short phillips screwdriver remove the (2) screws holding the magnet to the cart frame.

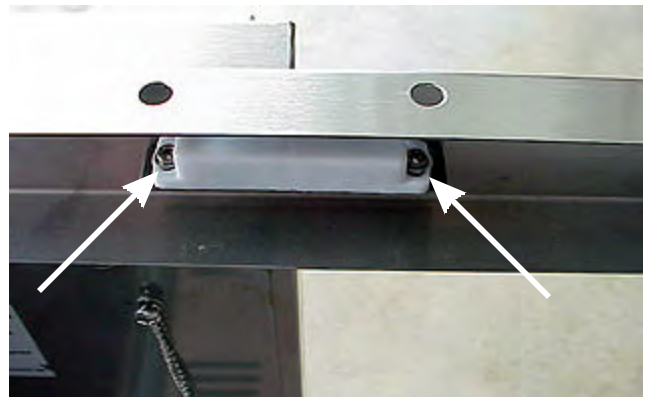

4. Remove the clip, pull the rod out of the top and lift the door off.

Removing the door hinges:

1. Remove the door.

Removing the cart's front frame:

1. Remove the grill from the cart.
2. Remove both doors.

3. Remove the (4) screws, (2) on each end, that hold the frame to the side panels and lift the frame out.

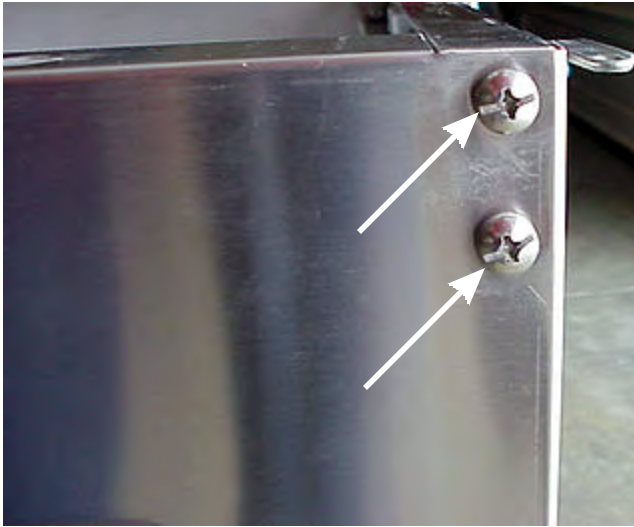

3. Remove the (2) screws holding the inside bottom flange of the side panel to the base and lift the panel off.

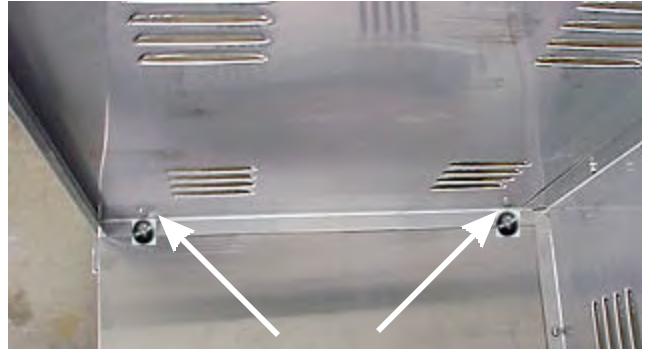

Removing the side panels:

1. Remove the grill from the cart.
2. Remove the (4) screws holding the side panel the front frame and the rear panel.



Removing the rear panel:

1. Remove the grill from the cart.
2. Remove the (4) screws, (2) on each end, holding the rear panel to the side panels.



2. Remove the (2) screws holding the inside bottom flange of the rear panel to the base and lift the panel off.

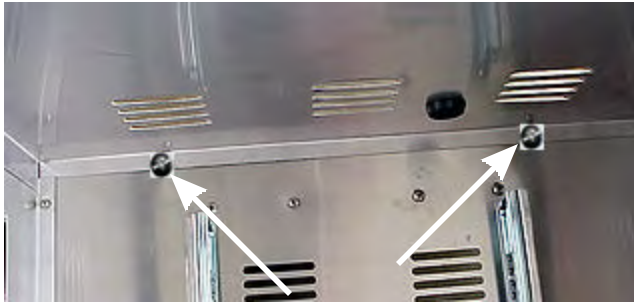

Removing the casters:

1. Remove the grill from the cart.
2. Lay the cart on it back and remove the (4) screws holding the caster to the base.



Removing the weights:

1. The weights are located on the bottom of the base toward the rear to prevent the grill from tipping.

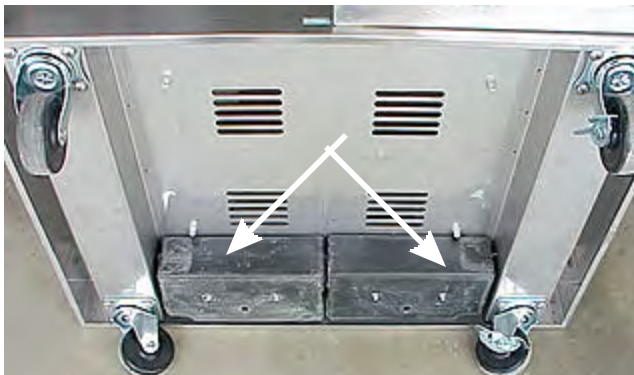

2. Each weight is held to the base by (2) bolt with the nuts counter sunk into the weight.
3. Remove the grill from the cart and lay the cart on it back.
4. To remove the weight use a phillips screwdriver from inside the cart and remove the (2) bolts holding the weight.

