

TITAN

aeroTECH™



Model OD301



Model OS301

MODELS

OD301US
OD301MUS
OD301MNZ

OS301US
OS301MUS
OS301MNZ

Contents

1. SERVICING REQUIREMENTS.....	6
1.1 HEALTH & SAFETY.....	6
1.1.1 Electrical Safety.....	6
1.1.2 Electrostatic Discharge.....	6
1.1.3 Good Working Practices.....	6
1.1.4 Insulation Test.....	6
1.1.5 Sheet Metal Edges.....	6
1.2 SPECIALIZED TOOLS.....	7
1.2.1 Static Strap.....	7
1.2.2 Fisher & Paykel Smart Tool.....	7
2. TECHNICAL OVERVIEW.....	8
2.1 OVEN SPECIFICATIONS.....	8
2.2 OVEN CAVITY DIMENSIONS.....	8
2.3 LOCATION OF SERIAL PLATE.....	8
2.4 MODEL NUMBER.....	8
2.5 SERIAL NUMBER.....	9
2.6 OVEN CAVITY FAN (CONVECTION FAN).....	9
2.7 COOLING FAN.....	10
2.8 EXHAUST FAN.....	10
2.9 OUTER BROIL / GRILL ELEMENT.....	11
2.10 INNER BROIL / GRILL ELEMENT.....	11
2.11 BASE ELEMENT.....	11
2.12 FAN ELEMENT.....	12
2.13 SMOKE ELIMINATOR ELEMENT.....	12
2.14 THROAT ELEMENT.....	12
2.15 TEMPERATURE SENSOR.....	12
2.16 HALOGEN BULBS.....	13
2.17 MEAT PROBE & SOCKET.....	13
2.18 DOOR LOCK MOTOR.....	13
2.19 TEMPERATURE SWITCH MODULE.....	13
2.20 TEMPERATURE L.C.D MODULE.....	13
2.21 FUNCTION SWITCH MODULE.....	13
2.22 FUNCTION L.C.D MODULE.....	14
2.23 CLOCK MODULE.....	14
2.24 POWER MODULE.....	14
2.25 POWER TRANSFORMER.....	15
2.26 COOLING FAN RESISTOR.....	15
2.27 THERMAL LIMITERS.....	15
2.28 ISOLATING RELAY.....	16
2.29 XY-CAPACITOR.....	17
2.30 MICRO SWITCHES.....	17
2.31 SELF-CLEAN PYROLYTIC CYCLE.....	17
2.32 OVEN MODE ELEMENT AND FAN PROFILES.....	19
3. USE & CARE OF THE OVEN.....	20
3.1 SETTING THE CLOCK.....	20
3.2 OVEN MODE DIAL AND DISPLAY.....	20
3.3 TEMPERATURE DIAL AND DISPLAY.....	20
3.4 OVEN MODES.....	20
3.5 ACTIVE VENT AND COOLING FANS.....	21
3.6 MINUTE TIMER.....	21
3.7 SET AUTOMATIC / DELAYED TIME COOKING.....	22
3.8 SET AUTOMATIC STOP COOKING.....	23
3.9 USER SELECT MODES.....	23
3.10 SABBATH MODE.....	23
3.11 TEMPERATURE SCALE.....	24
3.12 SHORT ALERT.....	24
3.13 TIME MODE.....	24

3.14	SHOW CLOCK	24
3.15	LANGUAGE.....	25
3.16	OVEN RESET.....	25
4.	DIAGNOSTICS.....	26
4.1	ENTERING THE TECHNICIAN MODE.....	26
4.2	EXITING THE TECHNICIAN MODE	26
4.3	TECHNICIAN MODE NAVIGATION	26
4.4	ACCESSING TECHNICAL DATA LOG	28
4.5	TECHNICAL DATA LOG	28
5.	FAULT DIAGNOSTICS.....	29
5.1	SYMPTOM: OVEN ELECTRICAL COMPONENTS ARE UNRESPONSIVE	29
5.2	SYMPTOM: CONTROL BUTTONS OR CLOCK DISPLAY NOT OPERATING CORRECTLY OR UNRESPONSIVE	30
5.3	SYMPTOM: TEMPERATURE OR OVEN MODE SWITCH MODULE IS JAMMED OR LOOSE.....	30
5.4	SYMPTOM: INCORRECT TEMPERATURE OR OVEN MODE DISPLAY AT CORRECT SWITCH POSITION	30
5.5	SYMPTOM: FAULTY TEMPERATURE OR OVEN MODE L.C.D. MODULES	31
5.6	SYMPTOM: “DOORLOCK” AND “PROBE” SHOWING FOR LOWER CAVITY	31
5.7	SYMPTOM: OVEN UNDER COOKING	32
5.8	SYMPTOM: BAKING BURNS ON THE TOP.....	33
5.9	SYMPTOM: BAKING BURNS ON THE BOTTOM.....	33
5.10	SYMPTOM: OVEN SEEMS TO BE FUNCTIONING NORMALLY BUT DOES NOT HEAT.....	34
5.11	SYMPTOM: OVEN HEATS SLOWLY OR FAILS TO REACH PRESET TEMPERATURE.....	34
5.12	SYMPTOM: OVEN LIGHTS DO NOT TURN ON / OFF.....	35
5.13	SYMPTOM: FAULT CODE F1 DISPLAYED IN TECH SELECT ONLY.....	35
5.14	SYMPTOM: FAULT CODE F2 DISPLAYED	35
5.15	SYMPTOM: FAULT CODE F3 DISPLAYED	36
5.16	SYMPTOM: FAULT CODE F4 DISPLAYED	36
5.17	SYMPTOM: FAULT CODE F5 DISPLAYED	36
5.18	SYMPTOM: FAULT CODE F7 DISPLAYED	36
5.19	TRACING COOLING FAN FAULTS	37
5.20	TRACING OVEN CAVITY FAN FAULTS.....	37
5.21	TRACING OVEN LIGHT FAULTS	38
5.22	TRACING ELEMENT FAULTS	39
5.23	TRACING OVEN TEMPERATURE SENSOR FAULTS.....	40
5.24	TRACING THERMAL LIMITER FAULTS.....	40
5.25	TRACING OVEN DOOR SWITCH AND DOOR LOCK SWITCH FAULTS	41
5.26	DETERMINING WHICH POWER MODULE IS FAULTY IN A DOUBLE OVEN (F4 OR F5 FAULT CODES).....	42
6.	WIRING DIAGRAMS.....	43
6.1	DOUBLE OVEN USA WIRING SCHEMATIC	43
6.2	SINGLE OVEN USA WIRING SCHEMATIC	44
6.3	DOUBLE OVEN NZ / AUS WIRING SCHEMATIC	45
6.4	SINGLE OVEN NZ / AUS WIRING SCHEMATIC	46
7.	SERVICE PROCEDURES	47
7.1	REMOVAL FROM JOINERY CAVITY.....	47
7.2	COMPONENTS IN CONTROL PANEL AREA.....	47
7.3	COMPONENTS IN BACK PANEL AREA.....	48
7.4	COMPONENTS IN SERVICE PANEL AREA.....	48
7.5	RE-ASSEMBLY PROCEDURE.....	48
7.6	FUNCTION AND TEMPERATURE SWITCH MODULES.....	49
7.7	FUNCTION AND TEMPERATURE L.C.D. MODULES AND LENSES.....	49
7.8	CLOCK MODULE.....	50
7.9	POWER MODULE	51
7.10	POWER TRANSFORMER	52
7.11	THERMAL LIMITER	52
7.12	OVEN TEMPERATURE SENSOR	53
7.13	OVEN LAMP GLASS AND BULB.....	53
7.14	OVEN LAMP ASSEMBLY	53
7.15	OVEN ELEMENTS	55
7.16	COOLING FAN.....	57
7.17	EXHAUST FAN	57
7.18	OVEN CAVITY FAN	58
7.19	FAN SHROUD	59

7.20 OVEN DOOR	59
7.21 OVEN DOOR – DISASSEMBLY	59
7.22 MEAT PROBE SOCKET	62
7.23 OVEN DOOR LOCK ASSEMBLY	62
7.24 COMPONENT LOCATION GUIDE	64

1. Servicing Requirements

1.1 Health & Safety

Note: When servicing the Aerotech™ oven, health and safety issues must be considered at all times. Specific safety issues are listed below with their appropriate icon. These are illustrated throughout the service information to remind service people of the health and safety issues.

1.1.1 Electrical Safety



WARNING! TO AVOID ELECTRIC SHOCK!

Do not attempt to service this oven without suitable training and qualifications.

Ensure the mains power has been disconnected before servicing any part of the oven. If the power is required to be on for electrical fault finding, then **extreme** care should be taken not to make contact with electrical components other than with testing probes. Ensure the oven is turned off when removing any electrical component or connection.

1.1.2 Electrostatic Discharge

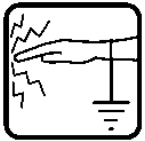

An anti-static strap is to be used as electrical static discharge (ESD) protection when servicing electronic components.

1.1.3 Good Working Practices



Ensure the work areas are kept tidy and free of hazards while servicing the oven. On completion of the servicing, ensure the oven and work areas are left clean and tidy.

1.1.4 Insulation Test



Megger test to check insulation.

1.1.5 Sheet Metal Edges



When working around cut sheet metal edges use appropriate gloves or protection to eliminate the chance of receiving a laceration.

1.2 Specialized Tools

1.2.1 Static Strap

The static strap is to be used as E.S.D. protection when replacing or handling electronic components.

1.2.2 Fisher & Paykel Smart Tool

Handheld computer supplied in protective case with F&P diagnostics software and service information loaded:

P/N 813140 (includes light pen P/N 425930).

2. Technical Overview

2.1 Oven Specifications

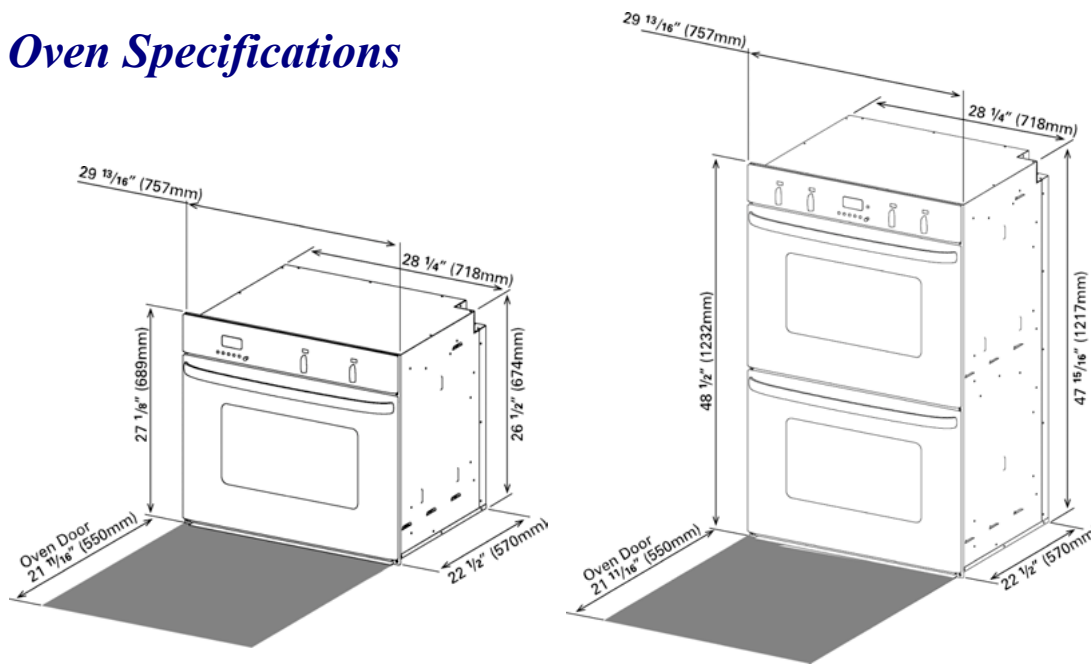

Weight: 190 lbs. (86 Kg)

Weight: 340 lbs. (154 Kg)

Power Rating:

	Single Supply Voltage	Rating	Double Supply Voltage	Rating
USA / Can	3wire 120/240v	5.1Kw	3wire 120/240v	9.2Kw
USA / Can	120/208v	3.9Kw	120/208v	7Kw
NZ / AUS	220/240v	4.7Kw	220/240v	8.5Kw

2.2 Oven Cavity Dimensions

Width	24"	(610mm)
Height	16"	(405mm)
Depth	16"	(405mm)
Cavity Volume	3.5 cu ft	(0.1 m ³)

2.3 Location of Serial Plate

The product serial plate is located on the left-hand side behind the grill, between the control panel and the oven door (top oven door on dual oven models).

2.4 Model Number

The model number contains the following information:

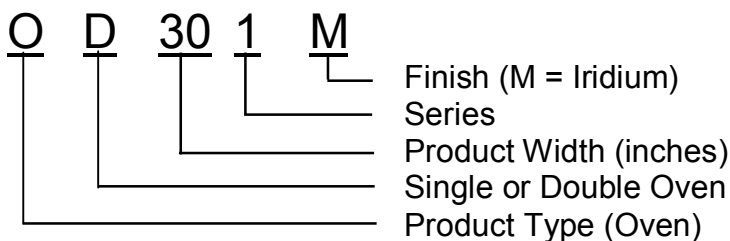

2.5 Serial Number

The serial number consists of three letters and six digits and contains the following information:

Example:

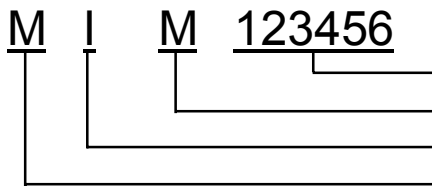

Sequential Serial Number
 Manufacturing Plant Code
 FISHERPAYKUL Code indicates month of manufacture
 CUMBERLAND Code indicates year of manufacture

Cumberland Code

Letter C	U	M	B	E	R	L	A	N	D
Year 1	2	3	4	5	6	7	8	9	0

Fisherpaykul Code

Letter F	I	S	H	E	R	P	A	Y	K	U	L
Month 1	2	3	4	5	6	7	8	9	10	11	12

Manufacturing Plant Code

A	Laundry – Australia
F	Refrigeration – New Zealand
M	Range & Dishwasher
N	Laundry – New Zealand
Q	Refrigeration - Australia

In the example above, the appliance was manufactured in the second month of the third year (2003) at the Range & Dishwasher plant.

2.6 Oven Cavity Fan (Convection Fan)

Note: The oven cavity fan should always run when the fan element is on.
 The fan will start 8 seconds after an Aero Oven Mode has been selected.

Operational Modes: True Aero
 Aero Bake
 Aero Pastry
 Aero Broil / Grill
 Self-Clean
 Roast (first 20min only)

Voltage: 240 VAC
Wattage: 35 watts
Frequency: 60 HZ

2.7 Cooling Fan

Notes:

The cooling fan will come on as soon as the oven mode is altered from the OFF position, but will turn off again after 8 seconds if no temperature is selected.

The cooling fan will stay on after an oven mode has been selected, and will turn off only if the oven cavity has cooled below 300°F (150°C).

If the temperature is above 550°F (290°C) the cooling fan will run at high speed.

During a self-clean cycle the cavity not being cleaned will have its cooling fan on low speed while the cavity being cleaned will be on high speed.

Voltage: 230/240 VAC
Frequency: 50/60 HZ
Wattage: 60 watt

Cooling Fan Speeds*

Oven Mode	Cooling Fan Speed
Bake	Low Low
Aero Bake	Low Low
Warm	Low Low
True Aero	Low Low
Maxi Broil / Grill	Hi Low
Broil / Grill	Hi Low
Aero Broil / Grill	Hi Low
Pastry Bake	Low Low
Aero Pastry	Low Low
Roast (Aero Broil / Grill 1 st 20 min)	Hi Low
Roast (Bake for remainder)	Low Low
Self-Clean Cycle *	Hi Low

***The top speed refers to single ovens or the cavity being used in a double oven.**

2.8 Exhaust Fan

Note: The exhaust fan will be on for all oven mode selections except for the warming mode.

Voltage: 230/240 VAC
Frequency: 50/60 HZ
Wattage: 18 watt

2.9 Outer Broil / Grill Element

Note: The outer broil / grill element will turn on 8 seconds after an oven mode that uses it, is selected.

Operational Modes: Bake
Aero Bake
Warm
Maxi Broil / Grill
Aero Broil
Roast
Self-Clean

Voltage: 230/240 VAC

Wattage: 1500 watt

2.10 Inner Broil / Grill Element

Note: The inner broil / grill element will turn on 8 seconds after an oven mode that uses it, is selected.

Operational Modes: Broil / Grill
Maxi Broil / Grill
Aero Broil
Roast
Self-Clean

Voltage: 230/240 VAC

Wattage: 2900 watt

2.11 Base Element

Note: The base element will turn on 8 seconds after an oven mode that uses it, is selected.

Operational Modes: True Aero (pre-heat assistance only)
Bake
Aero Bake
Warm
Pastry Bake
Aero Pastry
Roast
Self-Clean

Voltage: 230/240 VAC

Wattage: 1500 watt

2.12 Fan Element

Note: The fan element and oven fan will both turn on 8 seconds after an oven mode that uses them is selected.

Operational Modes: True Aero
Bake (pre-heat assistance only)
Aero Bake
Aero Pastry (pre-heat assistance only)
Pastry Bake (pre-heat assistance only)

Voltage: 230/240 VAC
Wattage: 2500 watt

2.13 Smoke Eliminator Element

(This is a non-serviceable part)

Note: This element is designed to neutralise gases produced during the broil / grill and self-clean oven modes.

Operational Modes: Broil / Grill
Maxi Broil / Grill
Self clean

Voltage: 230/240 VAC
Wattage: 150 watt

2.14 Throat Element

(This is a non-serviceable part)

Note: This element is designed to ensure all parts near the front of the oven cavity reach the required Pyro cycle temperatures during self-clean.

Operational Modes: Self-Clean

Voltage: 230/240 VAC
Wattage: 540 watt

2.15 Temperature Sensor

Voltage: 5 VDC
Max current: 2 mA
Max ambient temp: 1000°F (540°C)

2.16 Halogen Bulbs

Note: The lights will come on when the door is opened or when an oven mode is selected. The lights will turn off if the door is closed or if the oven cook time has finished. There are three soft start halogen bulbs in each oven cavity.

Voltage: 12 VAC
Wattage: 20 watt

2.17 Meat Probe & Socket

Voltage: 5 VDC



2.18 Door Lock Motor

Note: The door lock will only come on during the self-clean mode and is designed to stop the oven door being opened when very high temperatures and potentially dangerous fumes are produced in the oven cavity.

Voltage: 12 VDC
Duty cycle: On 2 sec Off 5 sec
Stall current: under 0.5 Amp

2.19 Temperature Switch Module

Note: This component controls the temperature settings of the oven and has a data link to the clock module.

Current Draw: 72 mA



2.20 Temperature L.C.D Module

Note: This component is controlled by the clock module, and displays the temperature set by the switch module.

Current Draw: 72 mA



2.21 Function Switch Module

Note: This component sets the oven mode to be used and has a data link to the clock module.

Current Draw: 72 mA



2.22 Function L.C.D Module

Note: This component is controlled by the clock module and displays the oven mode selected by the switch module.



Current Draw: 72 mA

2.23 Clock Module

Note: This module contains a flash micro-controller which controls all oven electrical components. Data can be read from the micro-controller using the Fisher & Paykel Smart Tool light pen or comms. connection.

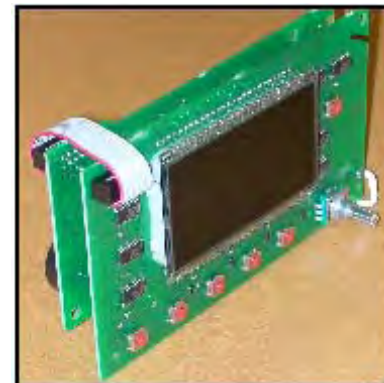

Current Draw: 200 mA

2.24 Power Module

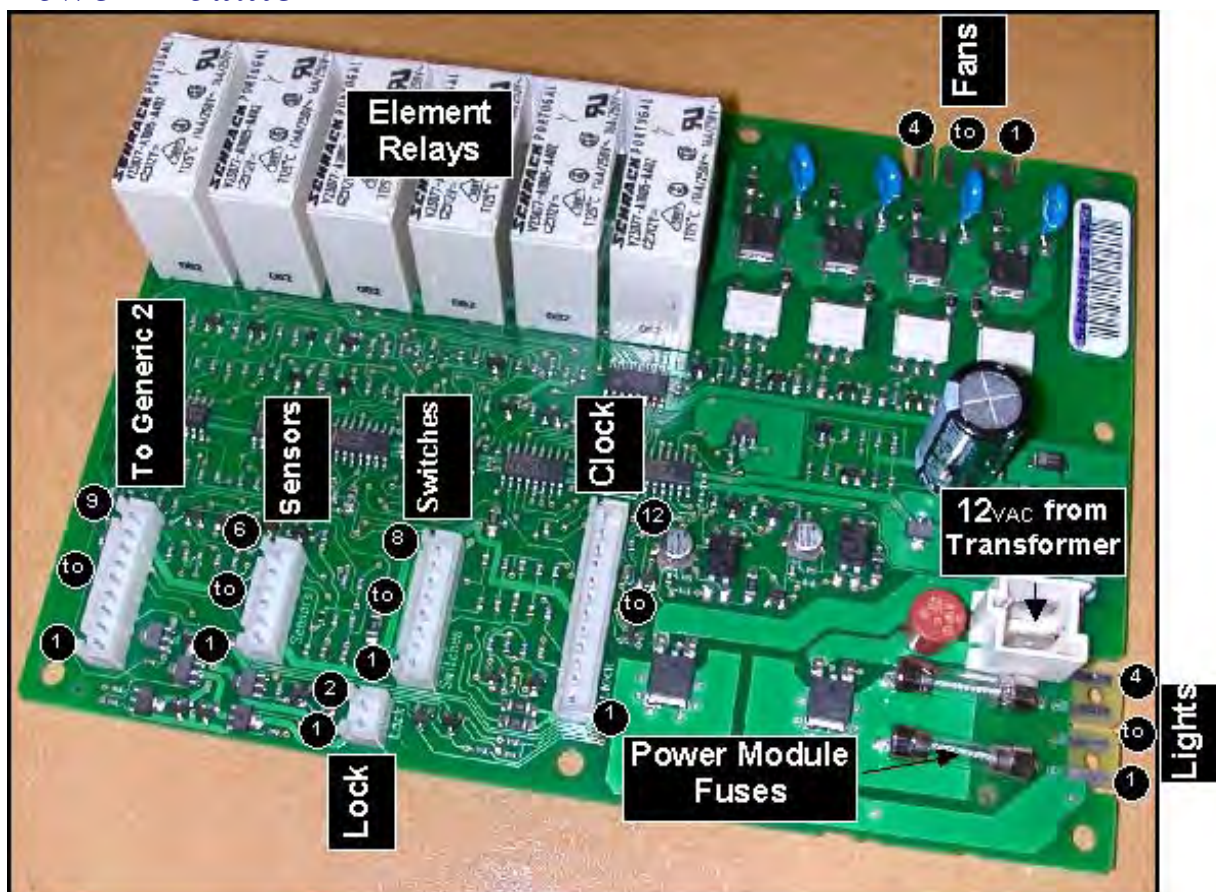

Note: This is a Fisher & Paykel specific P.C.B. that drives oven lights, fans, elements and lock motors. It also monitors the sensors and micro-switches and provides power to the control panel.

Voltage: 12 VAC

2.25 Power Transformer

USA	12v/120v	60hz
NZ/AUS	12v/240v	50hz

2.26 Cooling Fan Resistor

Power Rating:	50 watt
Resistance:	220 Ohms
Max Ambient Temp:	85°C (185°F)

2.27 Thermal Limiters

Note: If a thermal limiter has tripped there will be no continuity across the contacts.

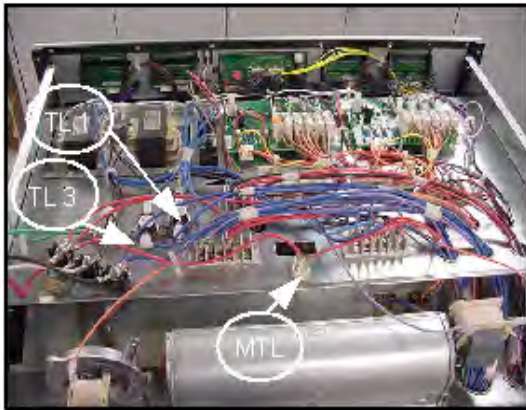

Note: TL = Thermal Limiter
MTL = Microtemp thermal limiter

Double ovens have thermal limiters 1,2,3,4&5 and a microtemp thermal limiter.

Single ovens have thermal limiters 1&2 and a microtemp thermal limiter.

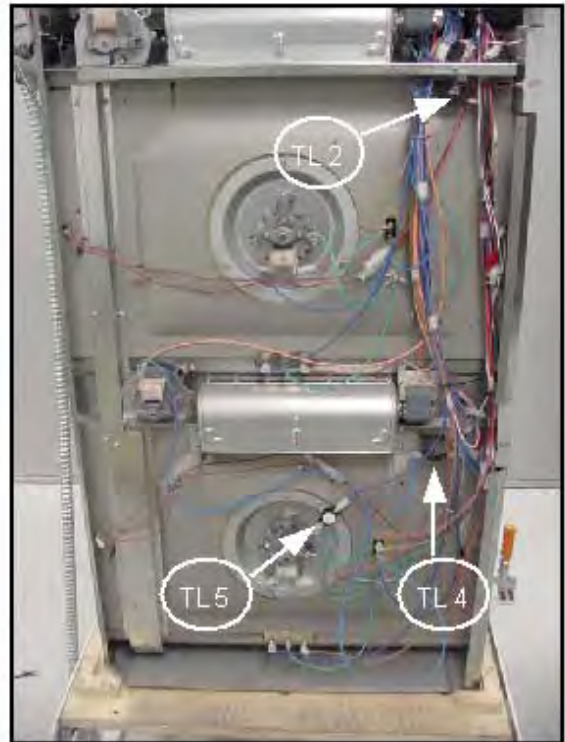

MTL (Microtemp Limiter)

This is a non-resettable thermal limiter positioned to detect electronics area over temperature caused by a cooling fan failure. When it trips it will cut power to the power transformers disabling the oven.

Capacity Rating: 25 Amps at 240 VAC.

Trip Temperatures: 200°F (93°C)

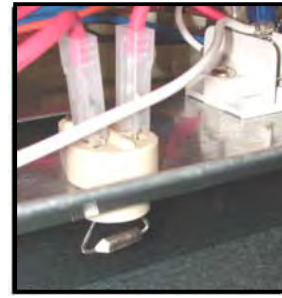

TL 1 & TL 3

These are non-resettable thermal limiters positioned to detect the lower cooling fan failure on a double oven. It will cut power to the oven elements when tripped.

Capacity Rating: 25 Amps at 240 VAC.

Trip Temperatures: 175°F (80°C)



TL 2

This is a non-resettable thermal limiter positioned to detect the upper cooling fan failing when using the lower cavity in a double oven. It will cut power to the oven elements when tripped.

Capacity Rating: 25 Amps at 240 VAC.

Trip Temperatures: 340°F (170°C)

TL 4

This is a non-resettable thermal limiter positioned to detect lower cavity element run-away in a double oven. It will cut power to the oven elements when tripped.

Capacity Rating: 25 Amps at 240 VAC.

Trip Temperatures: 300°F (150°C)

TL 5

This is a non-resettable thermal limiter positioned to detect element run-away and will cut power to the oven elements when tripped.

Capacity Rating: 25 Amps at 240 VAC.

Trip Temperatures: 230°F (120°C)

2.28 Isolating Relay

(Not in NZ / AUS models)

Note: This controls L2 of the elements, oven cavity fan and exhaust fan.

It does not switch the load and is only on when an oven mode is selected.

Coil Voltage 12 VDC

Coil Input 1 watt



2.29 XY-Capacitor

Note: This Capacitor provides surge protection for the oven.

Voltage:	250 VAC
Class:	X2Y2
Temp Range:	-105 to 210°F (- 40 to 100°C)

2.30 Micro Switches

Note: There are three micro switches in the door lock assembly.

Voltage	12 VDC
----------------	--------

2.31 Self-Clean Pyrolytic Cycle

Duration:	3hrs
Pyro Temp	925°F (500°C)
Heat-up time	50 minutes approx.
Holding time	100 minutes approx.
Cool-down time	30 minutes

The oven self-clean mode operates by heating the oven to a temperature of approximately 925°F (500°C). This burns off and breaks down soil and grease deposits. The ash residue that remains can simply be removed from the cool oven with a damp cloth or sponge. The self-clean cycle normally takes about 3 hours.

Turning the oven mode dial until 'Self Clean' appears in the display, then selecting the maximum temperature using the temperature dial starts the self-clean cycle. '000' will appear in the temperature display and this will change to  when the cycle begins.

In the clock display 'Door Lock' and 'Clean' will show. The door lock will automatically activate once the clean mode and temperature have been selected and in the clock display the countdown of minutes remaining in the self-clean cycle will be shown.

During the self-clean cycle, the Broil / Grill inner element, the throat element and the smoke eliminator elements are on. Additionally, during the first 15 seconds of each minute the base element is on, and during the third 15 seconds of each minute the Broil / Grill outer element is on.

The exhaust fan for the oven being cleaned will be on during the self-clean mode, while the cooling fan for that oven will be on high speed. The cooling fan for the other oven (in a dual oven model) will be on low speed.

During the self-clean operation in a dual oven model, the oven not being cleaned cannot be operated in any mode.

The oven heats to its cleaning temperature of 930°F (500°C) and maintains this temperature until approximately 2½ hours into the cycle. The elements then turn off and the cool down period commences. When the temperature reduces to 356°F (180°C) the door will unlock and the 'Door Lock' display will disappear from the clock display. When the self-clean cycle has finished, 'Clean' and '00:00' will flash in the clock display until it is

returned to manual operation. Pressing the PUSH TO CLEAR button and turning the oven mode and temperature dials to the OFF position does this.

At the completion of the self-clean cycle, there may be grey ash deposited on the inside of the oven. The amount of ash is dependent on the amount of soil present in the oven before it was cleaned. When the oven is completely cooled, the bulk of the ash is easily removed with a small brush or dry cloth, then the oven wiped over with a damp cloth.

The self-clean mode can be cancelled at any time by turning the oven dials off. 'Clean End' will appear in the oven mode display but if the oven temperature has already reached 482°F (250°C) the door lock will remain activated until the oven cools to 356°F (180°C).

2.32 Oven Mode Element and Fan Profiles

Note: If the oven door is opened during oven use the oven fan and elements will turn off until it is closed again.

Oven Mode Name	Oven Fan	Cool Fan Speed	Broil/Grill Outer Element	Broil/Grill Inner Element	Base Element	Fan Element	Throat Element	Smoke Elim.
Bake	(on for pre-heat only)	Low Low	ON		ON	(on for pre-heat only)		
Aero Bake	ON	Low Low	ON		ON	ON		
Warm	ON	Low Low	ON		ON			
True Aero	ON	Low Low			(on for pre-heat only)	ON		
Maxi Broil/Grill	OFF	Hi Low	ON	ON				ON
Broil/Grill	OFF	Hi Low		ON				ON
Aero Broil/Grill	ON	Hi Low	ON	ON				
Pastry Bake	(on for pre-heat only)	Low Low			ON	(on for pre-heat only)		
Aero Pastry	ON	Low Low			ON	(on for pre-heat only)		
Roast (Aero Broil/Grill 1 st 20Min)	ON	Hi Low	ON	ON				
Roast (Bake for remainder)	OFF	Low Low	ON		ON			
Heating Profile for Self-Clean Pyrolytic Cycle								
Self Clean (0-15sec)	OFF	Hi Low		ON	ON		ON	ON
(15-30sec)	OFF	Hi Low		ON			ON	ON
(30-45sec)	OFF	Hi Low	ON	ON			ON	ON
(45-60sec)	OFF	Hi Low		ON			ON	ON

3. Use & Care of the oven

3.1 Setting the Clock

The clock has a default 12 hour display and a minute timer function. 'AM 12:00' will be shown and the colon will flash when the oven has been turned on at the wall. While the colon is flashing, rotate the PUSH TO CLEAR knob until the correct time of day is displayed. Press CLOCK or wait 8 seconds until the colon stops flashing to adopt the time that has been set.

3.2 Oven Mode Dial and Display

This is turned to select the desired oven mode. When the mode is set the lights and cooling fan will come on.

3.3 Temperature Dial and Display

This is turned to select the desired temperature.

3.4 Oven Modes

The oven has 9 cooking modes plus *Warm* and *Self Clean*. These use different combinations of elements and oven fan as follows:



- True Aero. A concealed heating element surrounding the fan in the rear of the oven heats air, which is then blown into the oven cavity.

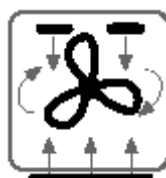

- Aero Bake. The oven fan circulates hot air from the top outer and the lower concealed elements.

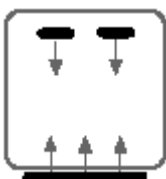

- Bake. Heat comes from the top outer and the lower concealed elements.



- Aero Pastry. Heat comes from the lower concealed element and is circulated throughout the oven cavity by the oven fan.

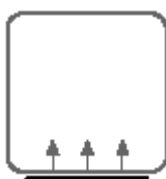

- Pastry Bake. Uses the heat from the lower concealed element only.

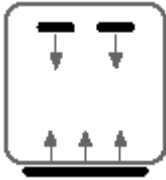

- Warm. This is a constant low heat of 75 degrees C (165 degrees F) from the top outer and the lower concealed elements.

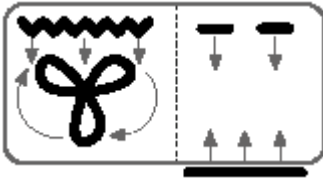

- Roast. This is a two step program where, during the first stage, the complete broil / grill element and the oven fan come on to sear the meat. The oven then automatically drops to a lower, selected temperature for the remainder of the cooking time. During this latter part of the cooking, the oven fan is off and the top outer and the lower concealed elements provide the heating.

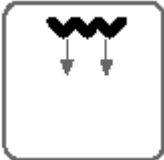

- Broil / Grill. Heat comes from the inner broil / grill element.

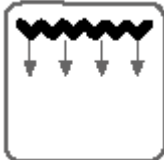

- Maxi Broil / Grill. Heat comes from both the inner and outer broil / grill elements.



- Aero Broil / Grill. Heat comes from both the inner and outer broil / grill elements and is circulated throughout the oven cavity by the oven fan.



- Self Clean. Refer to Section 2.31 for an explanation of how this function operates.

3.5 *Active Vent and Cooling Fans*

The active vent fan operates in all oven modes, when the oven door is closed, to extract oven cavity air. The cooling fans come on automatically whenever the ovens are in use and vent air out below the oven door. During *Broil / Grill, Maxi Broil / Grill and Self Clean*, the cooling fan runs at a higher speed to keep the oven exterior cool. (Refer to Section 2.7 for details of cooling fan speeds in various oven modes.)

3.6 *Minute Timer*

To set the timer, press **TIMER**. 'Timer' and the colon will flash in the clock display. Rotate the **PUSH TO CLEAR** button to select the time needed. Press **TIMER** or wait 8 seconds for the setting to be adopted and the timer will begin to count down. To cancel the timer, press **TIMER** and **PUSH TO CLEAR**.

When the set time finishes, 'Timer' and '00:00' will flash and the timer will beep. Press **TIMER** or **PUSH TO CLEAR** to stop the beeping and clear the timer.

The timer does not turn the oven off.

3.7 Set Automatic / Delayed Time Cooking

- Check that the clock shows the correct time.
- Select upper or lower oven cavity by pressing UPPER / LOWER (for double ovens only).
- Press the COOK TIME button. 'Cook Time' and 'Auto' will flash and '00:00' will show in the oven display. Turn the PRESS TO CLEAR knob to select the desired length of cooking time (e.g. 2 hours). The maximum cook time that can be selected is 23 hours 59 minutes.
- To set the time the oven is to turn off, press the STOP TIME button. 'Stop Time' and 'Auto' will flash in the oven display. Set the stop time by turning the PRESS TO CLEAR button.
- Choose the cooking mode and temperature required. These settings will automatically be adopted after 8 seconds or you can press the STOP TIME button.

Each of the steps in setting Automatic / Delayed Time Cooking must be started within 8 seconds of the previous step being completed, otherwise the clock display will revert to the time of day and the process will have to be started over again.

If there is time to wait before cooking starts, 'Delay' and 'Auto' will show in the clock display along with the current time. The oven mode and temperature displays will dim.

The oven mode and temperature dials will still function as in manual operation. They can be altered prior to or during cooking, and the oven can be manually turned off before the set Cook Time has elapsed.

During cooking, 'Auto' and the remaining cook time will be shown in the clock display. When the Cook Time is finished, the oven will beep and cooking will cease. The temperature and oven mode displays will dim and 'Cook Time' and 'Auto' will flash in the clock display. If the oven mode and temperature dials are turned to OFF, the oven will revert to normal operation after 8 seconds.

The Automatic / Delayed Time function can be cancelled at any time by turning the temperature and oven mode dials to OFF. After 8 seconds the clock display will revert to time of day.

3.8 *Set Automatic Stop Cooking*

Press the STOP TIME button and turn the PUSH TO CLEAR knob to display the time the oven is to switch off. Then choose the cooking mode and temperature. These settings will be adopted and will activate after 8 seconds. 'Auto' and the remaining cook time will show in the clock display. When the selected cooking time is finished, the oven will beep and cooking will cease. The temperature and oven mode displays will dim and 'Cook Time' and 'Auto' will flash in the clock display. If the oven mode and temperature dials are turned to OFF, the oven will revert to normal operation after 8 seconds.

3.9 *User Select Modes*

This allows the user to configure some of the settings displayed on the control panel. To enter User Select mode, ensure that the oven mode and temperature dials are off and that no automatic / delayed start programs are operating. Press the TIMER and then CLOCK buttons and hold down together until the oven beeps (about 2 seconds). The oven mode display (left hand one on dual ovens) will display 'User Select'.

The user select modes that can altered are as follows:

3.10 *Sabbath Mode*

Sabbath mode is designed for religious faiths that observe a 'no work' requirement on the Sabbath. When the oven is in Sabbath mode:

- The oven will not turn off automatically.
- Clock, temperature and oven mode displays will be disabled.
- No tones will sound.
- No error messages or temperature changes will be displayed.
- The oven cavity lights are on.

To set the Sabbath mode:

- Enter the User Select mode.
- Turn the oven mode dial until 'Sab Mode' appears in the display.
- Turn the PUSH TO CLEAR knob to select the length of time the oven is to be kept in Sabbath mode. The maximum is 99 hours in 1 hour steps. Turn the temperature dial to select a temperature. *Bake* is the only oven mode that can be used in Sabbath mode.
- To start Sabbath mode, press PUSH TO CLEAR. The oven mode will show 'Sab Mode' with no back light. The temperature display will show '---'. Temperatures can be adjusted but the display will not change.
- In double oven models, different temperatures can be selected for upper and lower cavities by using their temperature dials. The oven mode dial for the lower oven must be turned to *True Aero* to activate the oven, although it will operate in *Bake*.
- The oven can be turned off at any time during the Sabbath mode by turning the oven mode and temperature dials to the OFF position.
- The oven will not revert to normal operation until the set time has elapsed. Sabbath mode can be exited at any time by pressing the PUSH TO CLEAR button for 5 seconds.

3.11 Temperature Scale

The temperatures can be displayed as either Fahrenheit or Celsius.

To change temperature display:

- Enter the User Select mode.
- Turn the oven mode dial until 'Temp Scale' appears in the display.
- Press the PUSH TO CLEAR button to select either 'C' or 'F' in the clock display.
- Press the CLOCK button to activate.

3.12 Short Alert

By default setting, Short Alert is off and the audible beep will sound continuously at the end of cooking functions until cancelled by pressing the PUSH TO CLEAR button. When Short Alert is on, an audible beep will sound 5 times at the end of automatic cooking functions and when the timer finishes. After 5 beeps, the alert will stop, then repeat every 5 minutes until cancelled by pressing the PUSH TO CLEAR button. The clock display will flash continuously until cancelled.

To set the Short Alert:

- Enter the User Select mode.
- Turn the oven mode dial until 'Short Alert' appears in the display.
- Press the PUSH TO CLEAR button to select either 'ON' or 'OFF' in the clock display.
- Press the CLOCK button to activate.

3.13 Time Mode

The clock display can be altered to show the time in either a 12 hour or 24 hour format.

To change the clock display:

- Enter the User Select mode.
- Turn the oven mode dial until 'Time Mode' appears in the display.
- Press the PUSH TO CLEAR button to select either '12H' or '24H' in the clock display.
- Press the CLOCK button to activate.

3.14 Show Clock

This function can be used to hide the time in the clock display. All other functions, such as Timer, will continue to be shown as normal in the clock display when the time is hidden.

To hide the clock display:

- Enter the User Select mode.
- Turn the oven mode dial until 'Show Clock' appears in the display.
- Press the PUSH TO CLEAR button to select either 'ON' or 'OFF' in the clock display. Selecting 'OFF' will hide the clock display.
- Press the CLOCK button to activate.

3.15 Language

This can be set to display the various settings in either American English (US), English (EN), French (FR) or Spanish (SP).

To change the language setting:

- Enter the User Select mode.
- Turn the oven mode dial until 'Lang US' appears in the display.
- Press the PUSH TO CLEAR button to select 'US', 'EN', 'FR' or 'SP' in the clock display.
- Press the CLOCK button to activate.

3.16 Oven Reset

This will reset the Temperature Scale, Short Alert, Time Mode and Show Clock to the default settings. Sabbath Mode and Language settings will remain unaffected.

To reset:

- Enter the User Select mode.
- Turn the oven mode dial until 'Reset' appears in the display.
- Press the PUSH TO CLEAR button to select 'OFF' in the clock display.
- Press the CLOCK button to activate.

4. *Diagnostics*

4.1 *Entering the Technician Mode*

- (a) Ensure all oven modes and temperature displays are set to 'OFF'.
- (b) Ensure no cooking auto functions are set.
- (c) Enter **User Set Mode** by pressing 'TIMER' and then the 'CLOCK' button, hold for 2 seconds.
- (d) Turn the oven mode knob counter clockwise one position.
- (e) Enter **Sales Mode** by pressing 'TIMER' and then the "PROBE" button, hold for 5 seconds.

Note: If left in Sales Mode, only the oven displays will operate.

- (f) Return oven mode knob back to original position.
- (g) Enter **Technician Mode** by pressing 'TIMER' and then the 'STOP TIME' button. Hold for 2 seconds.
- (h) The Oven Mode Display will now show "TECH SELECT".

Note: The clock display will show the version of software installed in the product.

- (i) You are now in Technician Mode, oven diagnostics can be carried out.

4.2 *Exiting the Technician Mode*

- (a) To exit Technician Mode at any time press any button other than 'CLEAR' or 'TIMER'

4.3 *Technician Mode Navigation*

- (a) Ensure Oven Mode Display shows "TECH SELECT".
(Refer to Section 4.1)

- (b) Use the Oven Mode knob to navigate through the 19 Tech Select positions.

Note: If any position from 1 to 11 is selected then the components ON / OFF status is displayed in the oven temperature display. Push the clock twist button to turn the component ON or OFF.

When an element is turned ON the cavity temperature will be displayed instead of "ON".

Knob Position (clockwise)	Oven Mode Display	Description
1	TOP INNER	Broil/Grill Element Inner.
2	TOP OUTER	Broil/Grill Element Outer.
3	FAN ELEMNT	Fan Element and Oven Fan.
4	OVEN FAN	Oven Cavity Fan.
5	THROAT ELEMNT	Throat Element.
6	LOWER ELEMNT	Base Element.
7	COOLNG FAN	Cooling Fan.
8	CAT ELIM	Catalytic Smoke Eliminator.
9	CAVITY LIGHT	Cavity Lights.
10	LOCK MOTOR	Lock Motor.
11	VENT FAN	Exhaust Fan.
12	NUM CLEAN	Number Of Pyro Cycles performed. (Number of times oven has reached 912°F (490°C))
13	CLOCK TEMP	Clock Module Temperature.
14	PWR MD TEMP	Power Module Board Temperature.
15	MAX BOARD	Maximum Temperature recorded on any Board. (Push "CLEAR" to reset value)
16	CAVITY TEMP	The Cavity Temperature measured by the sensor.
17	FAULT CODE	The two most recent Fault Codes are displayed. (Refer to Note 1)
18	NUM DAYS	Shows the number of days the product has been on.
19	DOWN LOAD	Shows that data can now be downloaded. (Press "CLEAR" to begin Smart Tool Download)

Note 1:

When "FAULT CODE" is selected the oven temperature display will show the two most recent fault codes in the following temperature knob positions. If "OFF" is displayed then there are no faults logged.

Temperature Knob Position	Description
0	Most Recent Fault
1	2 nd Most Recent Fault

If the same fault occurs consecutively it will only be recorded as one fault. If the Most Recent Fault code is cleared from the log it will then be recorded as the 2nd Most Recent Fault. The Most Recent Fault position will be left blank.

Note: To clear a fault code from the log push "CLEAR" when it is displayed in the temperature display.

4.4 Accessing Technical Data Log

- (a) Enter Technician Mode (refer to Section 4.1)
- (b) Choose Tech Select option “DOWN LOAD”
- (c) Hold the Fisher & Paykel “Smart Tool” up to clock module display (top left corner) to initiate download.
- (d) Data can now be viewed on your PC.

4.5 Technical Data Log

The Technical Data Log has a PC interface containing several sections of information. These sections can be viewed as follows.

(a) Info Section

This section contains general identification information for the oven.

(b) Current / Previous Fault Information Sections

There are four sections displaying information on the two most recent fault codes for each oven cavity. The information contained details the oven settings, electronic board temperatures and the status of all oven outputs at the time the fault occurred.

(c) Status Section

This section details all the current user settings and the electronic software and hardware details.

Also included are the following details:

- Number of times each oven cavity was self-cleaned.
- Clock module board maximum temperature.
- The day maximum temperature occurred.
- Number of days the oven has been in operation since the power-up.
- Number of times the door has been opened.

(d) Function Log Section

This section details the last ten oven modes used and the oven settings the user selected.

(e) Self-Clean Log Section

This will record the last five self-clean cycles.

The following data will be recorded when the oven cavity temperature exceeds 550°F (288°C) and a self-clean cycle is set.

- Day number the Self-Clean Mode was used.
- Heat up time between 550°F (288°C) and maximum temperature.
- Maximum oven cavity temperature reached during Self-Clean.

5. *Fault Diagnostics*



5.1 *SYMPTOM: Oven electrical components are unresponsive*

POSSIBLE CAUSES:

- Blown fuse
- Faulty supply wiring or connections
- Faulty power transformer
- Tripped microtemp limiter
- Faulty power module

PROCEDURE

Check the circuit breaker or fuse at the switchboard (replace fuse if blown).

Test for correct supply voltage to transformers on main terminal block.
(120 volts in USA or 240 volts in NZ / AUS)
(Check wiring continuity back to switchboard if voltage not present).

Check power transformer by testing for 12_{VAC} on 2 way connector into power module.
(Refer to Technical Overview Section 2.24. Replace if no 12_{VAC})

Check for tripped microtemp limiter (Replace if tripped. Check the other thermal limiters and trace the likely cause also) (Refer to Section 5.24)

Check for blown power module fuse by testing for 12_{VDC} between pins 1 and 6 of the 12 way clock connector on the power module.
If no 12_{VAC} then fuse has blown. (Refer to Technical Overview Section 2.24. Replace power module if fuse has blown (refer to Servicing Instructions Section 7.9).

To trace cause of power module fuse blowing, refer below.

Tracing cause of power module fuse blowing:

Check resistance to earth of lamp wiring. (Replace lamp assembly if short circuit. Refer to Servicing Instructions Section 7.14).

Check power transformer by testing for 12_{VAC} on 2 way connector into power module.
(Replace transformer if more than 12_{VAC}).

5.2 SYMPTOM: Control Buttons or Clock Display not operating correctly or unresponsive

POSSIBLE CAUSES:

- Loose connection to power module
- Faulty clock module assembly
- Lens has come loose from adhesive
- Faulty power module

PROCEDURE:

If one of the clock display segments is flashing or is showing a warning then refer to the user guide for warning identification.

If one or more buttons are unresponsive then check all buttons to ensure they are not held down or jammed by the front panel. (Reassemble correctly if jammed).

If a clock segment or icon appears to be staying on or not lighting replace the clock module. (Refer to Servicing Instructions Section 7.8).

Replace the clock module if fault persists. (Refer to Servicing Instructions Section 7.8).

5.3 SYMPTOM: Temperature or Oven Mode Switch Module is jammed or loose

POSSIBLE CAUSES:

- Assembly is incorrect
- Switch has failed

PROCEDURE:

Check for correct assembly of the switch module. Reassemble correctly if faulty. (Refer to Servicing Instructions Section 7.6)

Replace the switch module if fault persists. (Refer to Servicing Instructions Section 7.6).

5.4 SYMPTOM: Incorrect Temperature or Oven Mode display at correct switch position

POSSIBLE CAUSES:

- Switch module is assembled incorrectly
- Switch module is faulty

PROCEDURE:

Check for correct assembly of switch module. Reassemble correctly if faulty. (Refer to Servicing Instructions Section 7.6).

Check all connections to the switch module and to the clock module.

If there are no connection faults then replace the switch module. (Refer to Servicing Instructions Section 7.6).

5.5 SYMPTOM: Faulty Temperature or Oven Mode L.C.D. Modules

POSSIBLE CAUSES:

- Loose connection to clock module
- Faulty temperature or oven mode L.C.D. module

PROCEDURE:

If the fault is that one segment of the display is always on or always off then replace the L.C.D. Module.

(Refer to Servicing Instructions Section 7.7).

If the L.C.D. module is displaying incorrect information, check that the connections from the L.C.D. module to the clock and switch modules are secure.

If there are no connection faults then replace the L.C.D. module. (Refer to Servicing Instructions Section 7.7)

Replace the switch module if no other faulty components can be found. (Refer to Servicing Instructions Section 7.6)

5.6 SYMPTOM: “DOORLOCK” and “PROBE” showing for lower cavity

POSSIBLE CAUSES:

Lower cavity power module has no power (double oven only).

PROCEDURE:

Check the connection between upper and lower cavity power modules.

Test for correct supply voltage to lower cavity power transformer.
(120volts in USA or 240 volts in NZ / AUS)

Check connection from the power transformer to lower cavity power module.

Check for blown power module fuse. Replace power module if fuse is blown and trace cause of fuse blowing. (Refer to Servicing Instructions Section 7.9)

Tracing cause of power module Fuse blowing:

Check resistance to earth of lamp wiring. Replace lamp assembly if low. (Refer to Servicing Instructions Section 7.14)

Ensure the supply voltage is correct. (120 volts in USA or 240 volts in NZ / AUS) Inform local power authority if incorrect.

5.7 SYMPTOM: Oven Under Cooking

POSSIBLE CAUSES:

- Incorrect oven use
- Incorrect temperature scale used
- Faulty temperature sensor
- Faulty oven element
- Blown thermal limiter
- Faulty power module

PROCEDURE:

Ensure the oven door is closed when using any oven mode.

Ensure the correct temperature scale has been set (°F or °C).

Check for 240volts across elements.

Check that the oven is being operated correctly. (Check the oven Use & Care Guide for troubleshooting tips).

Check that the correct oven mode has been selected.
(F&P Smart tool can be used to view previous oven modes used. Refer Diagnostics Section 4.4).

Check for temperature sensor faults.
(Refer to Section 5.23)

Check for tripped thermal limiters.
(Refer Section 5.24)

Check for oven element faults.
(Refer to Section 5.22)

Replace the power module if no other faulty components can be found.
(Refer to Servicing Instructions Section 7.9)

5.8 SYMPTOM: *Baking burns on the top*

POSSIBLE CAUSES:

- Incorrect oven use
- Incorrect temperature scale used
- Faulty temperature sensor
- Faulty oven element
- Faulty power module

PROCEDURE:

Check the oven Use & Care Guide for troubleshooting tips

Ensure the correct temperature scale has been set (°F or °C).

Check that the correct Oven Mode has been selected. (F&P Smart tool can be used to view previous oven modes used. Refer Diagnostics Section 4.5)

Check for temperature sensor faults.
(Refer to Section 5.23)

Check for oven element faults. Especially check the upper elements.
(Refer to Section 5.22)

Replace the power module if no other faulty components can be found.
(Refer to Servicing Instructions Section 7.9)

5.9 SYMPTOM: *Baking burns on the bottom*

POSSIBLE CAUSES:

- Incorrect oven use
- Incorrect temperature scale used
- Faulty temperature sensor
- Faulty oven element
- Faulty power module

PROCEDURE:

Check the oven Use & Care Guide for troubleshooting tips

Ensure the correct temperature scale has been set (°C or °F)

Check that the correct Oven Mode has been selected. (F&P Smart tool can be used to view previous oven modes used. Refer Diagnostics Section 4.5).

Check for temperature sensor faults.
(Refer to Section 5.23)

Check for oven element faults, especially the base element.
(Refer to Section 5.22).

Replace the power module if no other faulty components can be found.
(Refer to Servicing Instructions Section 7.9)

5.10 SYMPTOM: Oven seems to be functioning normally but does not heat

POSSIBLE CAUSES:

- Oven still in Sales Mode (Refer Section 4.0 Diagnostics).
- Faulty oven door switch or door not closed
- Tripped thermal limiter
- Faulty temperature sensor
- Faulty oven element
- Faulty power module

PROCEDURE:

Check to see if the door switch is operating correctly and the door is closed.
(Refer to Section 5.25)

Check for tripped thermal limiters.
(Refer Section 5.24)

Check for temperature sensor faults.
(Refer to Section 5.23)

Check for oven element faults.
(Refer to Section 5.22)

Replace the power module if no other component faults can be found.
(Refer to Servicing Instructions Section 7.9)

5.11 SYMPTOM: Oven heats slowly or fails to reach preset temperature

POSSIBLE CAUSES:

- Incorrect oven use
- Faulty door switch
- Low supply voltage
- Faulty temperature sensor
- Faulty oven element
- Faulty power module

PROCEDURE:

Ensure the oven door is closed properly during all oven cooking modes.

Check for door switch faults.
(Refer to Section 5.25).

Check for 240volts across elements.

Check for temperature sensor faults.
(Refer to Section 5.23).

Check for oven element faults. (Refer to Section 5.22).

Replace the power module if no other component faults can be found.
(Refer to Servicing Instructions Section 7.9)

5.12 SYMPTOM: Oven Lights do not turn On / Off

POSSIBLE CAUSES:

- Blown oven light bulbs
- Faulty oven door switch
- Faulty wiring
- Faulty power module

PROCEDURE:

Replace bulb if only one light not working.

Check for oven door switch faults if lights do not turn off.
(Refer to Section 5.25).

Check for oven light faults.
(Refer to Section 5.21).

Replace the power module if no other component faults can be found.
(Refer to Servicing Instructions Section 7.9)

5.13 SYMPTOM: Fault Code F1 displayed in Tech Select only (Refer to 4.0 Diagnostics)

CAUSE:

Maximum allowable temperature (185°F, 85°C) around electronics was exceeded.

PROCEDURE:

Check for cooling fan fault or vent blockages. (Refer to Section 5.19)

5.14 SYMPTOM: Fault Code F2 displayed

CAUSE:

Maximum allowable cavity temperature was exceeded during Self-Clean Pyro cycle.

PROCEDURE:

Check for temperature sensor faults.
(Refer to Section 5.23)

Check for oven element faults.
(Refer to Section 5.22).

Replace the power module if no other component faults can be found.
(Refer to Servicing Instructions Section 7.9).

5.15 SYMPTOM: Fault Code F3 displayed

CAUSE:

The oven temperature is sensed at over 600°F (315°C) during normal cooking operation.

PROCEDURE:

Check for temperature sensor fault.
(Refer to Section 5.23)

Check for oven element faults
(Refer to Section 5.22)

Replace the power module if no other component faults can be found.
(Refer to Servicing Instructions Section 7.9)

5.16 SYMPTOM: Fault Code F4 displayed

CAUSE:

A fault occurred in the power module.

PROCEDURE:

Check all the connections to the power module and clock module.

If fault code re-occurs, then replace the power module.
(Refer to Servicing Instructions Section 7.9)

5.17 SYMPTOM: Fault Code F5 displayed

CAUSE:

A communications error occurred between the clock module and the power module.

PROCEDURE:

Ensure that the connection between the power module and clock module is secure.

If fault code re-occurs then replace the power module.
(Refer to Servicing Instructions Section 7.9).

5.18 SYMPTOM: Fault Code F7 displayed

CAUSE:

Oven door lock fault occurred.

PROCEDURE:

Check that the oven door lock has not jammed.
(Refer to Servicing Instructions Section 7.23).

Note: The door does not lock or unlock in normal operation with the door open or with the oven cavity temperature over 600°F (315°C). However it will operate with the door open in diagnostics.

Check for oven door switch and door lock switch faults.
(Refer to Section 5.25).

Check for temperature sensor faults.
(Refer to section 5.23).

Replace the power module if no other component faults can be found.
(Refer to Servicing Instructions Section 7.9)

5.19 Tracing Cooling Fan Faults

Refer to Technical Overview Section 2.7

PROCEDURE:

If cooling fan will not start.

Check cooling fan operation in Technician Mode. (Refer to Diagnostics Section 4.3).

Note: The cooling fan will be operating in low speed when in normal operation. When the cooling fan is turned on in diagnostics it will run at high speed.

Test for 240volts across contacts or substitute fan with a dummy load. Replace fan if 240 volts is present or if dummy load operates.
(Refer to Servicing Instructions Section 7.16).

Check fan wiring continuity back to power module.

If wiring continuity is good then it is likely that the cooling fan is not faulty. (Refer back to Symptom Procedure Checklist for further component tests).

If Cooling Fan will not stop.

Check for temperature sensor faults.
(Refer to Section 5.23).

Note: The cooling fan will operate on low speed until the cavity temperature is below 300°F (150°C). If the cavity temperature is above 520°F (270°C) the cooling fan will stay on high speed.

Replace power module if no other component faults can be found.
(Faulty Cooling Fan TRIAC).
(Refer to Servicing Instructions Section 7.9)

5.20 Tracing oven cavity fan faults

Refer to Technical Overview Section 2.6

PROCEDURE:

If oven cavity fan will not operate

Enter Technician Mode diagnostics to test oven cavity fan operation
(Refer to Diagnostics Section 4.3)

Check for door switch faults if the oven cavity fan operates in diagnostics but not in normal operation.
(Refer to Section 5.25)

Test for 240volts across contacts or substitute fan with a dummy load. Replace fan if 240volts are present or if dummy load operates.
(Refer to Servicing Instructions Section 7.18).

Check the continuity of the fan wiring back to power module including thermal limiters and the isolating relay.

Note: Isolating relay only used in USA and Canada.

If the wiring continuity is good, then it is likely that the oven cavity fan is not faulty. (Refer back to Symptom Procedure Checklist for further component tests).

Oven cavity fan will not stop.

Replace power module.

(Faulty Oven Cavity Fan TRIAC)

(Refer to Servicing Instructions Section 7.9)

5.21 Tracing oven light faults

Refer to Technical Overview Section 2.16

PROCEDURE:

If only one light will not turn on

Replace halogen bulb.

(Refer to Servicing Instructions Section 7.13)

If all lights will not turn on or replacing the bulbs did not fix the problem.

Check the continuity of the light wiring back to power module.

(Refer to Technical Overview Section 2.24 for light connector location).

Replace lamp assembly if no continuity.

(Refer to Servicing Instructions Section 7.14).

Check power module light connector for 12_{VAC}, across pins 1&2 and 1&3. (Refer to Technical Overview Section 2.24).

Replace lamp assembly if 12_{VAC} present.

(Refer to Servicing Instructions Section 7.14).

If no 12_{VAC} across light connector then check for 12_{VAC} supply from transformers and correct power supply from the switchboard.

Replace power module if transformers and supply power is correct.

(Refer to Servicing Instructions Section 7.9)

If wiring continuity is good and 12_{VAC} is present then it is likely that the oven lights are not faulty. (Refer back to Symptom Procedure Checklist for further component tests).

If lights do not turn off

Check to see if the door switch is faulty by selecting an Aero Oven Mode. If the oven cavity fan starts after 8 seconds with the door open, then the switch is faulty.

If the faulty door switch cannot be easily remedied then replace door lock assembly.

(Refer to Servicing Instructions Section 7.23)

5.22 *Tracing element faults*

Refer to Technical Overview Section 2.9, 2.10, 2.11, 2.12 & 2.32

PROCEDURE:

Element does not turn off (element run-away)

Note: In normal operation the element will cycle (turn On & Off) when the cavity temperature has reached the set point. This can be detected by listening for the switching noise of the element relay switch on the power module or using a current meter.

Check that the temperature sensor is reading the correct temperature.
(Refer to Section 5.23)

If the correct temperature is being read, turn the power off. Check that all the elements are wired correctly and that the relays are not short circuit across the terminals.

Element does not heat up

Check for tripped thermal limiter.
(Refer to section 5.24)

Test element operation in Technician Mode.
(Refer to Diagnostics Section 4.3)

Note: Before testing refer to Technical Overview Sections 2.9, 2.10, 2.11, 2.12 & 2.32 to find out which elements are used for each oven mode.

If element does not heat up in Technician Mode then test for 240volts across contacts or substitute element with a dummy load. Replace element if 240volts is present or if dummy load operates.
(Refer to Servicing Instructions Section 7.15)

Check isolating relay by testing for 240volts across relay HV contacts and 12VDC across relay LV contacts from the transformer. Replace isolating relay if 12VDC supplied but no 240volts across relay. (Power must be on when checking).

Note: Isolating relay only used in USA and Canada.

Check continuity of element wiring back to the power module, including the thermal limiters and the isolating relay. (Power must be on when checking).

If wiring continuity is good then it is likely that the element is not faulty. (Refer back to Symptom Procedure Checklist for further component tests).

5.23 Tracing oven temperature sensor faults

Refer to Technical Overview Section 2.15

PROCEDURE:

Enter Technician Mode diagnostics to view cavity temperature reading.
(Refer to Diagnostics Section 4.3)

Record cavity temperature reading then substitute the oven temperature sensor with a new sensor.

(Refer to Servicing Instructions Section 7.12)

Record cavity temperature reading from new sensor.

If there is a significant difference between the two temperature readings ($>10^{\circ}\text{F}$ or $>5^{\circ}\text{C}$) then leave the new sensor in.

If the two temperature readings are similar ($\pm 10^{\circ}\text{F}$) ($\pm 5^{\circ}\text{C}$) check temperature sensor wiring connectors and connection to power module.

If connections are good then it is likely that temperature sensor is not faulty.

Refit the original temperature sensor.

(Refer to Servicing Instructions Section 7.12).

If the fault persists, then test power module by substituting 1000 ohm 5% resistor across pins 1&2 on the "Sensors" connector.

(Refer to Technical Overview Section 2.24 for pin numbering)
The temperature display should read $32^{\circ}\text{F} \pm 10^{\circ}\text{F}$ ($0^{\circ}\text{C} \pm 5^{\circ}\text{C}$).

Replace power module if the displayed reading is incorrect.

(Refer to Servicing Instructions Section 7.9)

5.24 Tracing thermal limiter faults

Refer to Technical Overview Section 2.27

Note: In the event of a thermal limiter tripping, it is important that the cause be found and rectified.

PROCEDURE:

Do a continuity test between L2 and the terminal block side of the isolating relay.

Note: Isolating relay only used in USA and Canada.

Note: To do a quick check for a tripped microtemp limiter test for 12_{VAC} on 2 way connector into power module from transformer.

(Refer to Technical Overview Section 2.24)

If there is no continuity then this indicates a tripped thermal limiter.

To locate the tripped thermal limiter check for continuity across the limiter contacts.

Replace any faulty thermal limiter with one having the same trip temperature.
(Refer to Servicing Instructions Section 7.11)

Trace the component that is most likely to have caused the thermal limiter to trip.

Tracing likely cause of tripping:

Note: Thermal limiters are positioned in specific places to detect certain components failing. These positions and the components they monitor are listed in the Technical Overview Section 2.27.

Determine likely faulty component.
Trace likely component fault.

Note: These are the most likely causes of a thermal limiter tripping

Faulty cooling fan (stopped running). Refer to Section 5.19

Faulty element (element run-away). Refer to Section 5.22

Faulty temperature sensor (incorrect reading) Refer to Section 5.21

5.25 Tracing oven door switch and door lock switch faults

Refer to Technical Overview Section 2.30

PROCEDURE:

Oven Door Switch

Push the door switch in and out to ensure it is not stuck.

Check to see if the door switch is faulty by holding the switch in for 8 seconds. If the oven lights switch OFF then the door switch is not faulty.

If the oven lights do not switch ON and OFF then check for wiring continuity between the door lock assembly and the power module.

If the wiring continuity is good then replace the door lock assembly.
(Refer to Servicing Instructions Section 7.22)

Door Lock Switch

Test to ensure lock switch is switching properly.

Note: Use a multimeter to check that the lock switch readings back to the power module are correct. When the door is unlocked lock switch 1 inputs should be short circuit and lock switch 2 inputs should be open circuit. (Vice-versa for when the door is locked).

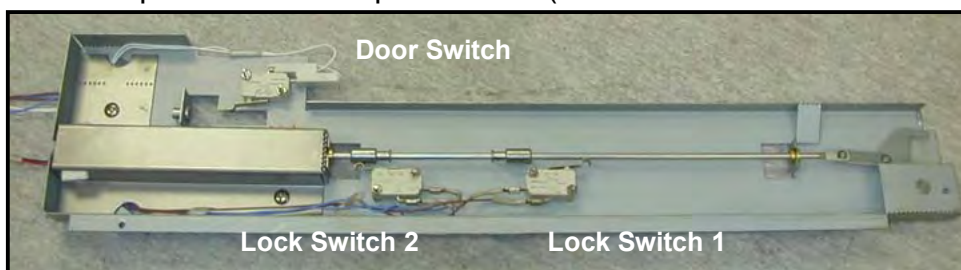

Check wiring continuity and earth insulation back to the power module.

Replace door lock assembly if wiring continuity or insulation resistance faults cannot be remedied. (Refer to Servicing Instructions Section 7.22).

If the wiring continuity and insulation resistances are good, then it is likely that these switches are not faulty. (Refer back to Symptom Procedure Checklist for further component tests).

5.26 Determining which power module is faulty in a double oven (F4 or F5 Fault Codes)

Refer to Technical Overview Section 2.24

Set-up double oven as if it were a single oven so that the faulty power module can be eliminated.

PROCEDURE:

For Upper Cavity power module:

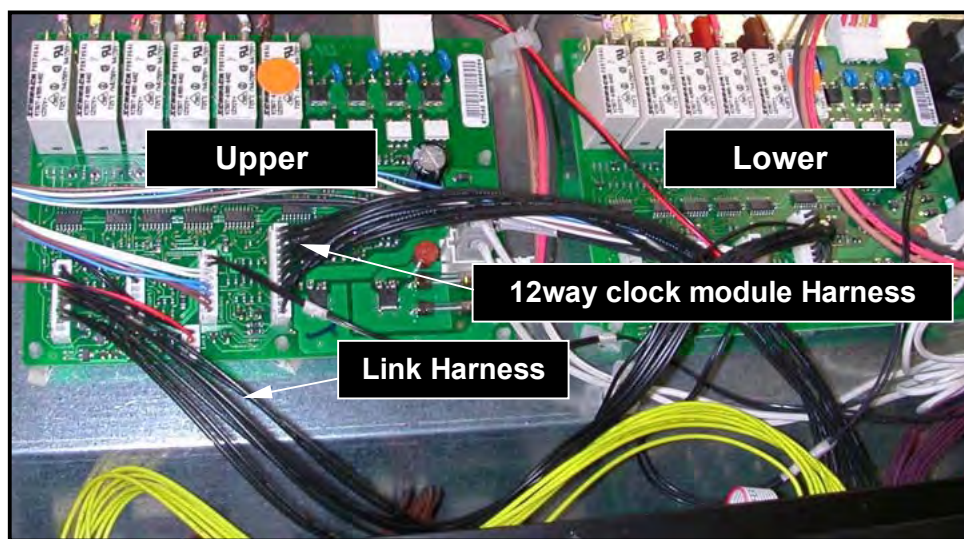

Unplug purple harness from clock module.

Remove link harness to lower cavity power module.
(The clock module now assumes there is only one power module. The second power module will run in a powered but disabled mode i.e. elements will not operate).

Try to operate the upper cavity. If the fault code reappears then the upper cavity power module is faulty and needs to be replaced.
(Refer to Servicing Instructions Section 7.9)

If the fault code does not reappear, then check for lower cavity power module faults.

For Lower Cavity power module.

Disconnect the clock module from the upper cavity power module at the power module end of the black 12 way harness.

Disconnect link harness between the upper and lower cavity power modules.

Plug the clock module harness into the link harness slot on the lower cavity power module.

Try to operate the lower cavity using the upper cavity controls.

If the fault code reappears then the lower cavity power module is faulty and needs to be replaced. (Refer to Servicing Instructions Section 7.9)

6. Wiring Diagrams

6.1 Double Oven USA Wiring Schematic

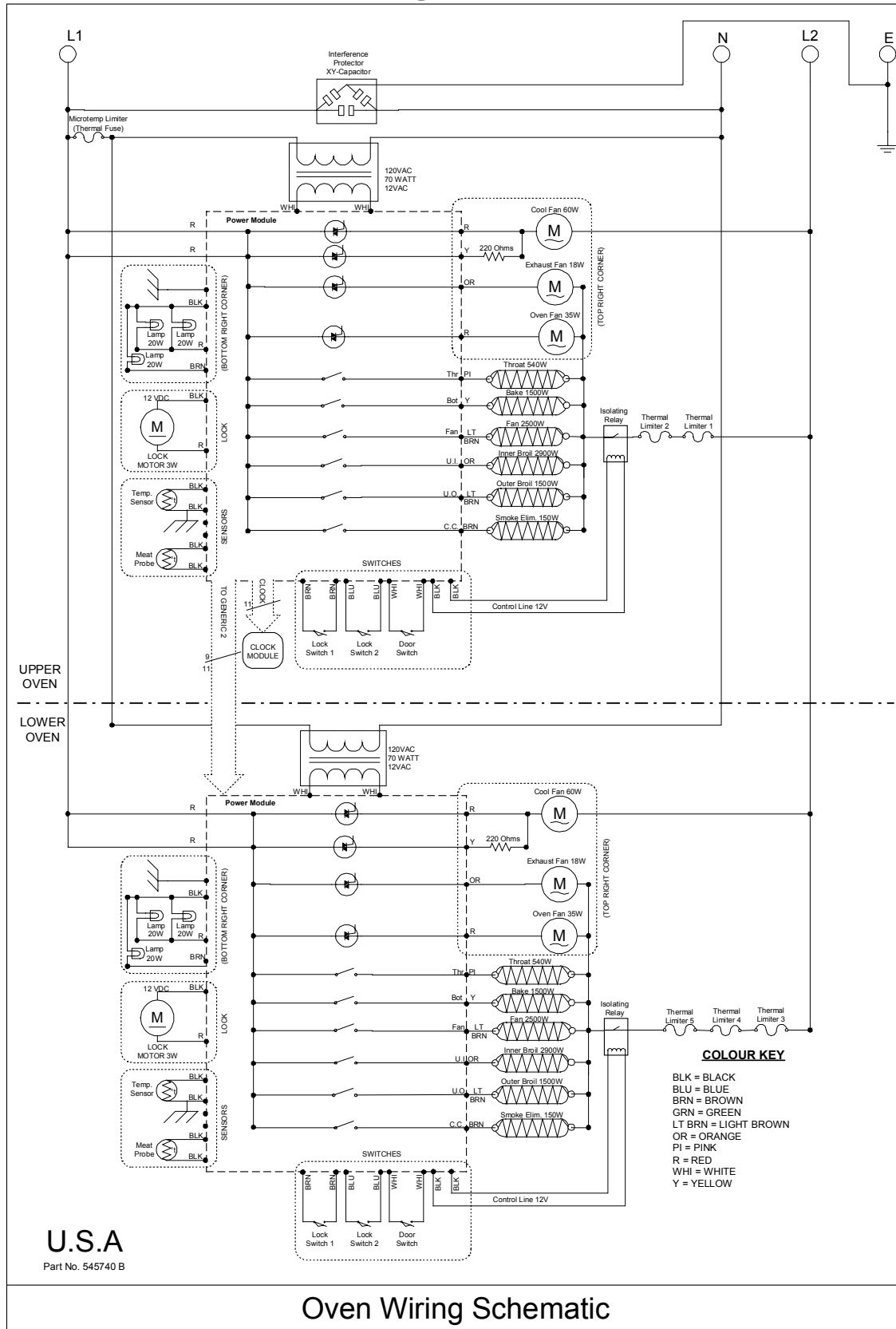

6.2 Single Oven USA Wiring Schematic

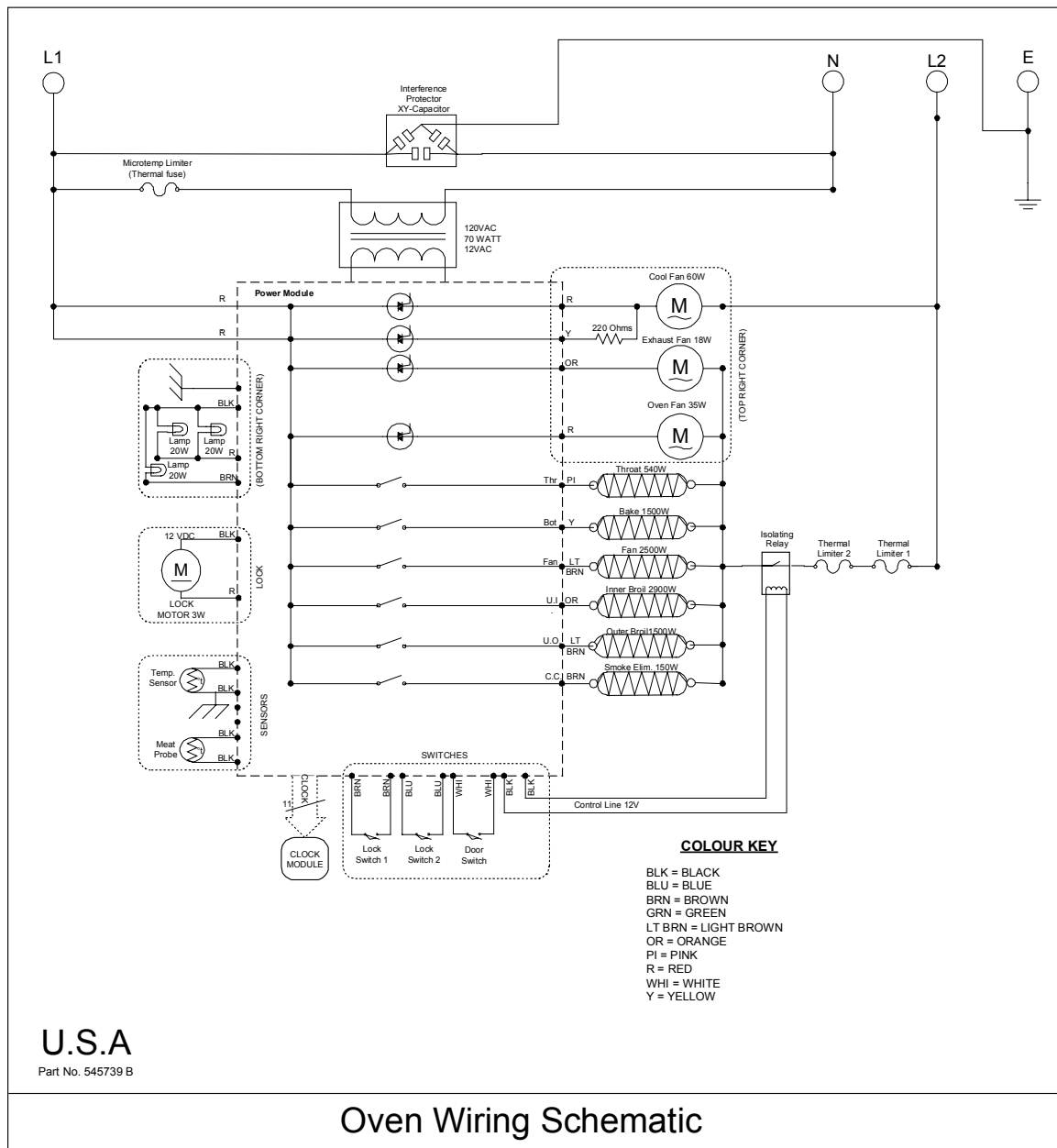

6.3 Double Oven NZ / AUS Wiring Schematic

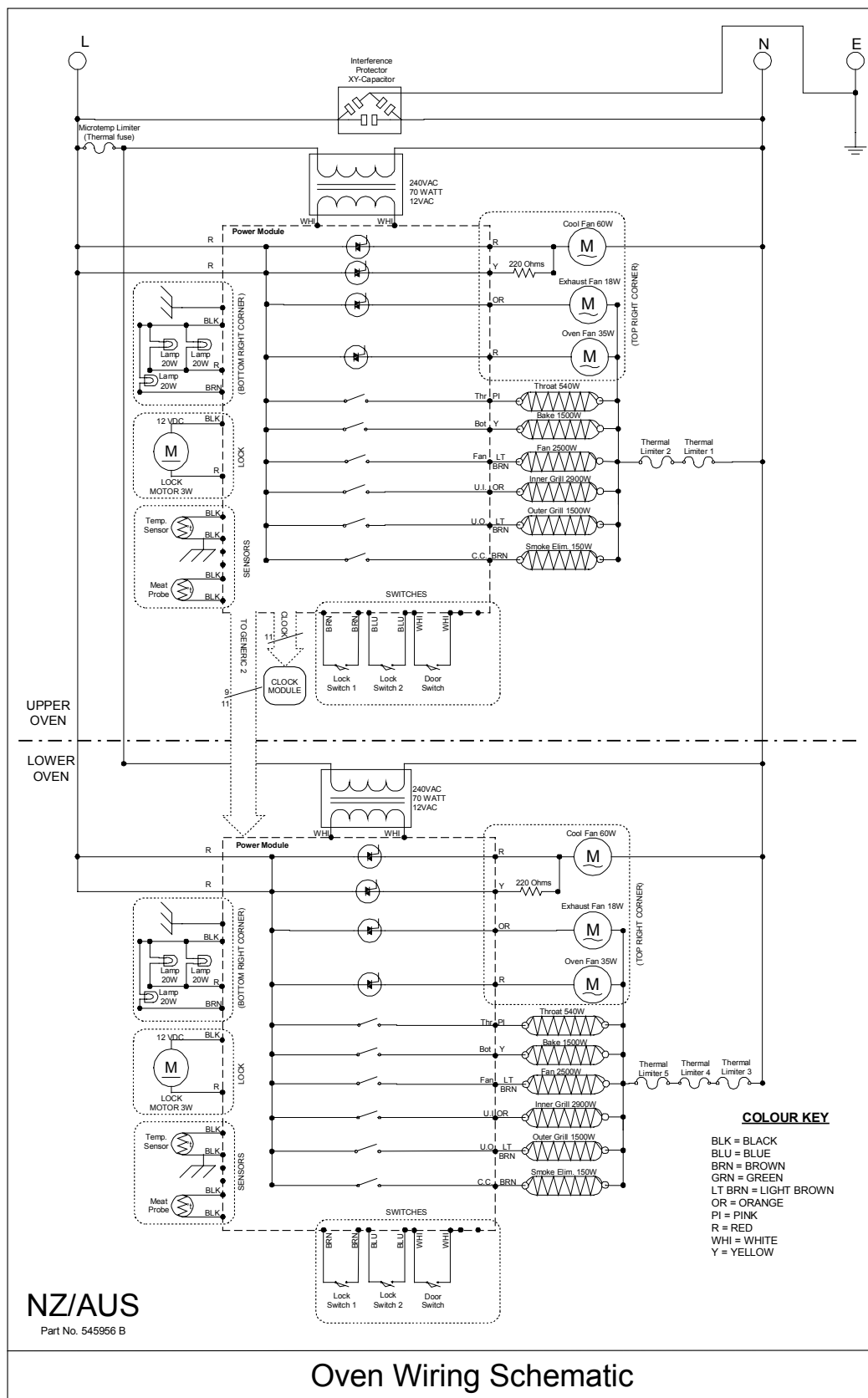

6.4 Single Oven NZ / AUS Wiring Schematic

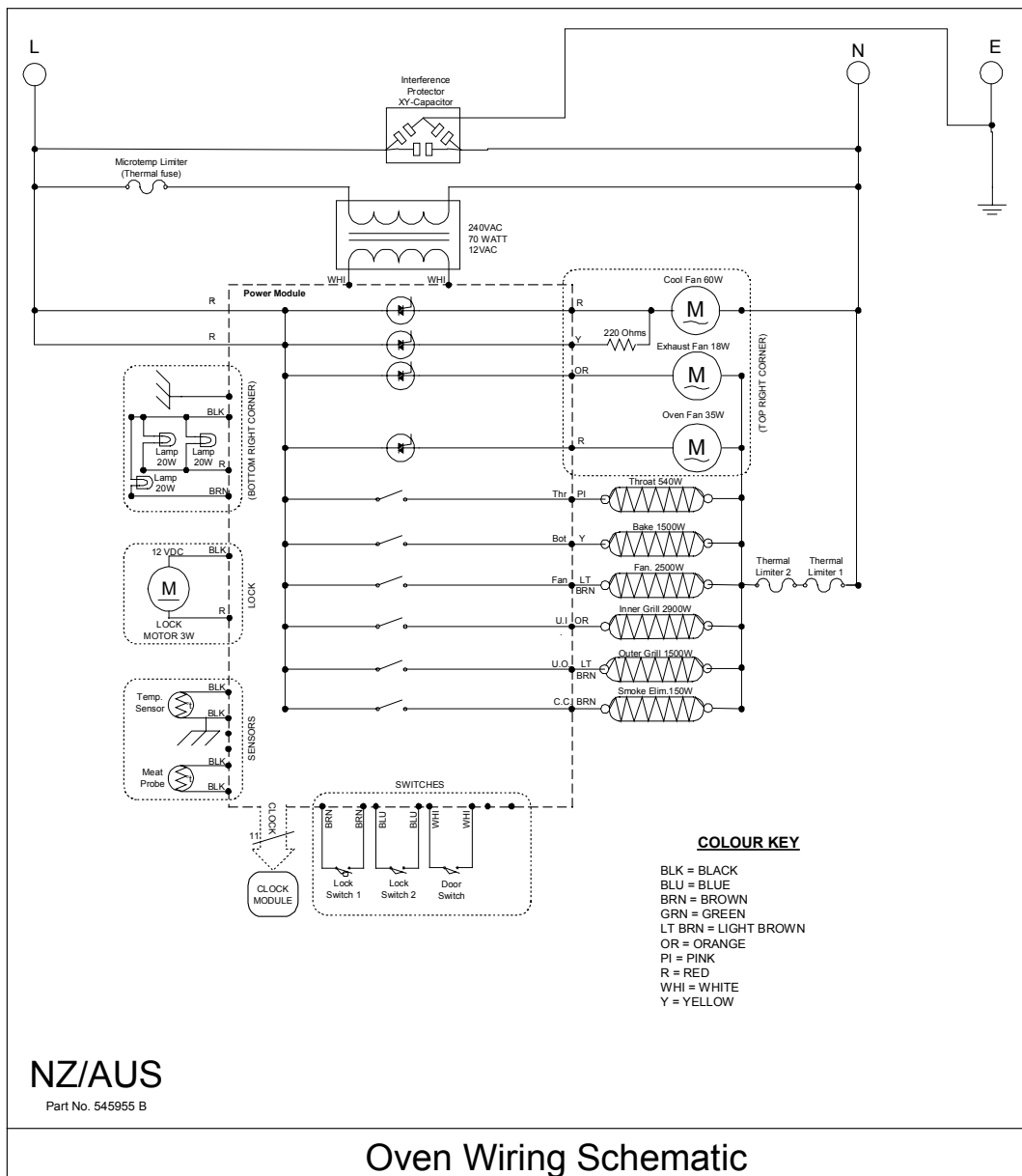

7. *Service Procedures*

In order to service components of the Aerotech™ oven, certain procedures must be followed. These procedures are as follows:

Servicing Note

- (a) To avoid stripping screws do not over-tighten when re-assembling parts. If using a screw gun have the torque setting on low.
- (b) Take extra care not to damage wire terminals on removal as some have release clips.

7.1 *Removal from Joinery Cavity*



- (a) Disconnect unit from power supply.
- (b) **Remove oven doors**, (Refer to Section 7.20), shelves and utensils.
- (c) Remove four screws on face of oven frame that secure oven to joinery.
- (d) Slide oven out of joinery cavity onto a suitable support.

Warning: This oven is heavy and care should be taken to use correct lifting techniques.

Note: When servicing components in the control panel and service panel areas the oven does not need to be completely removed from joinery cavity. Sliding the oven out 8 inches (200mm) will give sufficient access space.

Re-assembly

- (a) Re-fit in reverse manner

7.2 *Components in Control Panel Area*

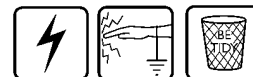

- (a) Remove from joinery cavity. (Refer to Section 7.1).

Warning: To avoid the oven tipping forward, remove shelves, doors and utensils. (Refer to Section 7.20)

Note: The oven does not need to be removed completely from joinery cavity. Sliding the oven out 8 inches (200mm) will give sufficient access space.

- (b) Detach control panel from frame by unscrewing four screws located either side of the rear of control panel and four screws along top of control panel.
- (c) Remove wiring harness from power module.
- (d) The function, temperature and clock modules are now accessible.

Re-assembly

- (a) Re-fit in reverse manner.

7.3 *Components in Back Panel Area*



- (a) Remove oven from joinery cavity. (Refer to Section 7.1).
- (b) Remove the six rear-most screws on top panel.
- (c) Remove two screws fixing the cable connector panel to back panel.
- (d) Remove back panel retaining screws and lift off back panel. Components at back of oven will now be accessible.

Re-assembly

- (a) Re-fit in reverse manner.
- (b) Follow re-assembly procedure (Refer to Section 7.5).

7.4 *Components in Service Panel Area*



- (a) Remove from joinery cavity. (Refer to Section 7.1).

Warning: To avoid the oven tipping forward remove shelves, doors and utensils. (Refer to Section 7.20).

Note: The oven does not need to be removed completely from joinery cavity. Sliding the oven out 8 inches (200mm) will give sufficient access space.

- (b) Remove four screws securing service panel to the control panel, and three screws fixing service panel to the top panel.
- (c) Lift off service panel. The power module and other electronics can now be accessed.

Re-assembly

- (a) Re-fit in reverse manner.
- (b) Follow re-assembly procedure (Refer to Section 7.5).

7.5 *Re-assembly Procedure*



- (a) After repairing or replacing components, ensure that all wiring terminals are correct and tight. Restore power and test repaired or replaced components. (Refer to Diagnostics Section 4.3)
- (b) Disconnect from power supply before re-fitting appropriate panels.
- (c) Slide oven back into joinery cavity and ensure the four securing screws are fitted.
- (d) Re-fit oven doors.
- (e) Restore power and check oven modes.
- (f) Reset time on clock.
- (g) Replace oven trays, shelves and utensils.

7.6 *Function and Temperature Switch Modules*



Location: Control Panel.

Removal

- (a) Follow general servicing instructions for components around control panel area (Refer to Section 7.2).
- (b) Pull off temperature and oven mode knobs and the clock twist button.

Note: To best work on the control panel turn it face down and place blocks of wood under the ends to elevate it off the working surface. Ensure there is some padding between the control panel and the block of wood to avoid marking.

- (c) Remove ten screws securing top and bottom powder coated trims.



Note: Trims are not identical so care must be taken to re-fit them correctly.

- (d) Disconnect earth wire from tab on mounting panel.
- (e) Lift off mounting panel.
- (f) Remove retaining nut and washer of faulty module.
- (g) Disconnect wiring harnesses and transfer to replacement module.
- (h) Remove plastic mounting bracket from faulty module and transfer to replacement module.

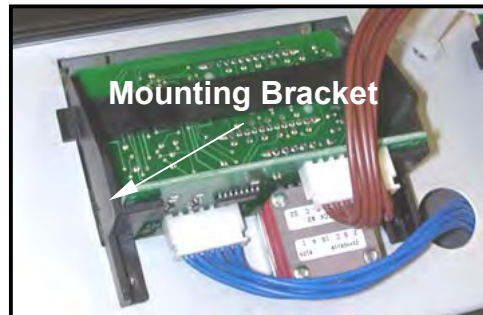

Re-assembly

- (a) Re-fit in reverse manner.

Note: Ensure wiring harness wires are clear of possible crush points when re-assembling.

- (b) Follow re-assembly procedure (Refer to Section 7.5).

7.7 *Function and Temperature L.C.D. Modules and Lenses*



Location: Control Panel.

L.C.D Modules:

Removal

- (a) Follow general servicing instructions for components around control panel area (Refer to Section 7.2).
- (b) Remove temperature and oven mode knobs and the clock twist button.
- (c) Remove ten screws securing top and bottom powder coated trims.

Note: Trims are not identical so care must be taken to re-fit them correctly. (Refer to photo in Section 7.6)

- (d) Disconnect earth wire from mounting panel.
- (e) Lift off mounting panel.
- (f) Unclip faulty module from retaining lens and lift out.
- (g) Disconnect wiring harness and transfer to replacement module.

Note: Take extreme care so as not to leave fingerprints or visible marks on any lens surface.

Re-assembly

- (a) Remove protective strip from L.C.D module screen.
- (b) Re-fit in reverse manner.

Note: Ensure wiring harness wires are clear of possible crush points when re-assembling.

- (c) Follow re-assembly procedure. (Refer to Section 7.5).

L.C.D Lenses:

Removal

- (a) Follow procedure for removal of L.C.D modules above up to step (f).
- (b) Pull off damaged lens and clean old adhesive strip area.
- (c) Remove adhesive tape backing strip from replacement lens.
- (d) Remove protective strip from L.C.D lens.
- (e) Attach replacement lens ensuring it is fitted squarely.

Note: Take extreme care so as not to leave fingerprints or visible marks on any lens surface.

Re-assembly

- (a) Re-fit in reverse manner.

Note: Ensure wiring harness wires are clear of possible crush points when re-assembling.

- (b) Follow re-assembly procedure (Refer to Section 7.5).

7.8 *Clock Module*



Location: Control Panel

Removal

- (a) Follow general servicing instructions for components around control panel area (Refer to Section 7.2).
- (b) Remove temperature and oven mode knobs and the clock twist button.
- (c) Remove ten screws securing top and bottom powder coated trims.

Note: Trims are not identical so care must be taken to re-fit them correctly. (Refer to photo in Section 7.6)

- (d) Disconnect earth wire from mounting panel.

- (e) Lift off mounting panel.
- (f) Lift out faulty clock module.
- (g) Disconnect wiring harness and transfer to replacement clock module.
- (h) Remove protective strip from clock module screen.

Note: Take extreme care so as not to leave fingerprints or visible marks on any lens surface.

Re-assembly

- (a) Re-fit in reverse manner.

Note: Ensure wiring harness wires are clear of possible crush points when re-assembling.

- (b) Follow re-assembly procedure. (Refer to Section 7.5).

7.9 Power Module



Location: Under service panel

Removal

- (a) Follow general servicing instructions for components around service panel area (Refer to Section 7.4).
- (b) Remove all wires and wire harnesses and transfer to replacement power module. (Refer to Technical Overview Section 2.24)

Note: Label relay switch wires before removing to ensure correct connection to replacement power module.

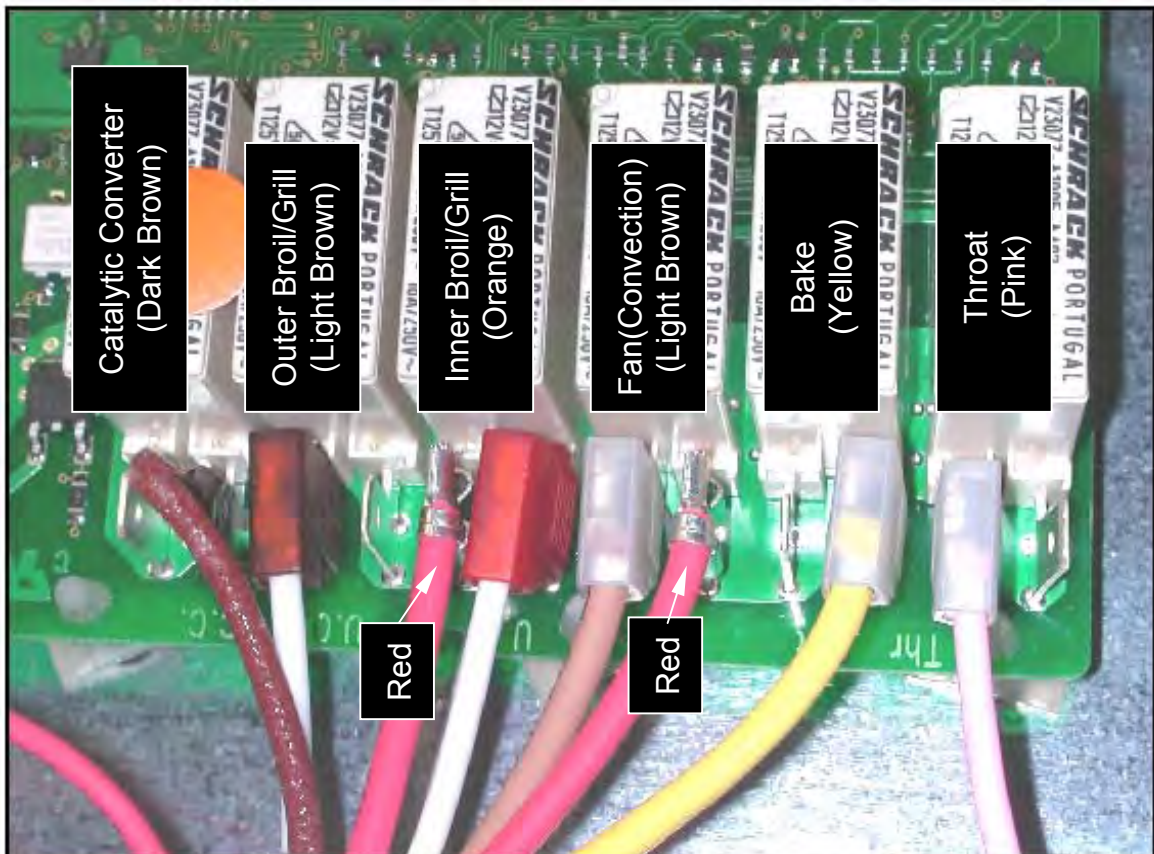

- (c) Lift power module off the seven P.C.B Stand-Offs.

Note: Use a small pair of needle-nose pliers to force in plastic barbs on P.C.B stand-offs in order to lift the board up.

- (d) Fit replacement power module.

Re-assembly

- (a) Re-fit in reverse manner.
- (b) Follow re-assembly procedure. (Refer to Section 7.5).



7.10 Power Transformer



Location: Under service panel

Removal

- (a) Follow general servicing instructions for components around service panel area (Refer to Section 7.4).
- (b) Remove top panel.
- (c) Remove two wires from power terminal block and two wires from power module. (Refer to Technical Overview Section 2.24)

Note: Ensure that when removing any wires from power connector block that they are replaced onto the correct terminals.

- (d) Remove four transformer retaining screws and lift out transformer.

Note: Ensure replacement transformer has the correct voltage and frequency.

Re-assembly

- (a) Re-fit in reverse manner
- (b) Follow re-assembly procedure. (Refer to Section 7.5).

7.11 Thermal Limiter



Location: In back panel, top panel and service panel areas.

Removal

Note: Refer to the Technical Overview for thermal limiter locations and specifications.

- (a) Follow servicing instructions for components around back panel and service panel areas. (Refer to Sections 7.3 & 7.4).
- (b) Remove top panel.
- (c) Remove wires from faulty thermal limiter.
- (d) Remove retaining screws and replace old thermal limiter.

Re-assembly

- (a) Re-fit in reverse manner.
- (b) Follow re-assembly procedure. (Refer to Section 7.5).

7.12 Oven Temperature Sensor

Location: Oven cavity rear top left corner.

Removal

- (a) Remove oven fan shroud (Refer to Section 7.19)
- (b) Remove two screws securing the sensor to the oven cavity.
- (c) Pull sensor wires through hole in oven cavity wall until wire connector is accessible.
- (d) Disconnect faulty sensor and connect replacement.

Re-assembly

- (a) Push excess wire back through hole in oven cavity.
- (b) Re-fit in reverse manner.
- (c) Follow re-assembly procedure (Refer to Section 7.5).

7.13 Oven Lamp Glass and Bulb

Location: Oven cavity back corners and top of oven cavity opening.

Removal

- (a) Remove glass by swivelling retaining tab up to clear edge of glass.
The glass will now drop out.

Note: Retaining tabs are designed to be swivelled using a flat head screwdriver.

- (b) Pull out faulty bulb and insert replacement.

Note: Do not handle bulbs with bare hands. Use gloves or a cloth rag.

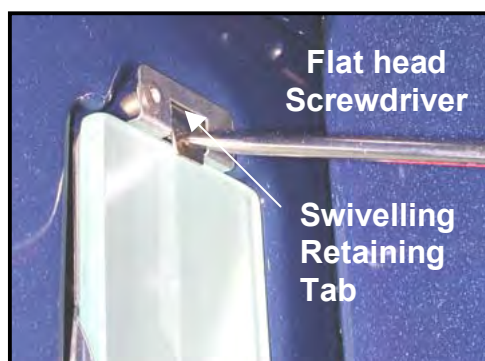

Re-assembly

- (a) Re-fit in reverse order.

Note: Ensure frosted side of lamp glass is facing side of oven cavity.

7.14 Oven Lamp Assembly



Location: Oven cavity back corners and top of oven cavity opening.

For Rear Lamp Assemblies

Removal

- (a) Follow general servicing instructions for components in back panel area. (Refer to Section 7.3).
- (b) Remove lamp glass and bulb. (Refer to Section 7.13)
- (c) Remove two lamp assembly retaining screws.

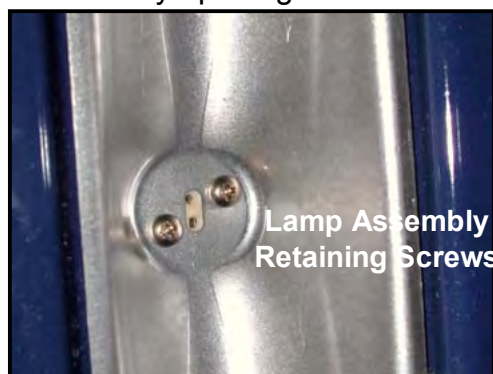

- (d) Disconnect wire connector in back panel area.
- (e) Pull the light assembly wires out through oven cavity until wire connectors are accessible.

Note: String can be tied on the end of the light assembly wires to aid in feeding the wires back through the holes in the side insulation panel.

Re-assembly

- (a) Feed new wire connectors back through the holes in the side insulation panel.
- (b) Follow re-assembly procedure. (Refer to Section 7.5).

For Front Lamp Assembly

Removal

- (a) Follow general servicing instructions for components in control panel area. (Refer to Section 7.2)
- (b) Remove lamp glass and bulb. (Refer to Section 7.13)
- (c) Remove two lamp assembly retaining screws.
- (d) Disconnect wires from terminal block in top panel area.
- (e) Remove 3 screws along front of wiring panel and 2 screws either side fixing wiring panel.
- (f) Lift front of wiring panel to access lamp wires
- (g) Pull wires through hole in wiring panel and through wire looms.

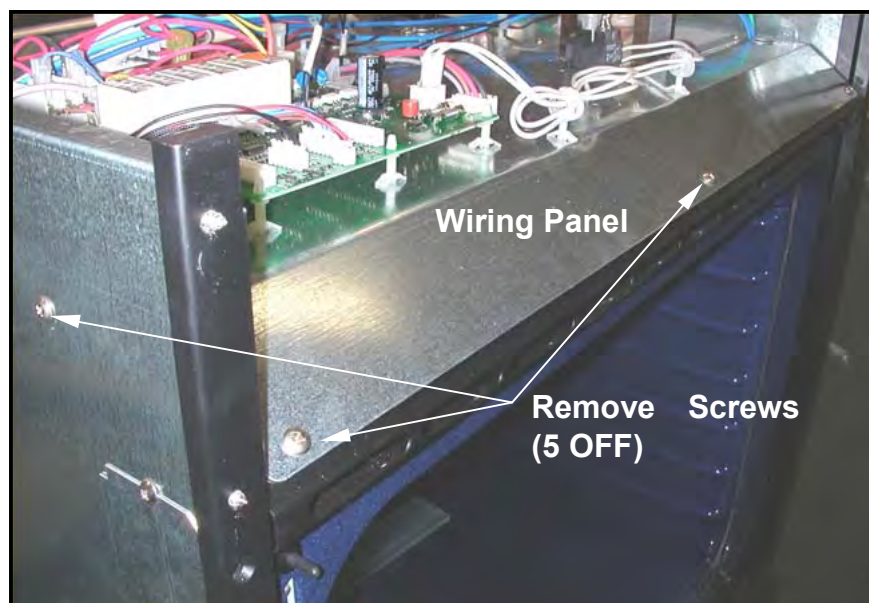

Re-assembly

- (a) Feed new wire back through the hole in the wiring panel.
- (b) Follow re-assembly procedure. (Refer to Section 7.5).

7.15 Oven Elements



Broil / Grill Elements

Location: Top of oven cavity

Removal

- (a) Disconnect unit from power supply.
- (b) Remove fan shroud (Refer to Section 7.19)
- (c) Remove two screws securing Broil / Grill elements to top of oven cavity and two screws securing support frame to cavity roof.
- (d) Pull Broil / Grill elements through hole in oven cavity until element terminals are accessible.

Note: Tilt elements forward so that the element terminals will clear hole in oven cavity.

- (e) Disconnect wires and connect to replacement elements.

Re-assembly

- (a) Re-fit in reverse manner.
- (b) Restore power.
- (c) Check element operation and reset clock time.
(Refer to Diagnostics Section 4.3).

Fan Element



Location: Rear of oven cavity

Removal

- (a) Disconnect unit from power supply.
- (b) Remove fan shroud (Refer to Section 7.19).
- (c) Remove three screws securing fan element to rear of oven.
- (d) Pull element through hole in oven cavity until wires are accessible.
- (e) Disconnect wires and connect to replacement element.

Re-assembly

- (a) Re-fit in reverse manner.
- (b) Restore power.
- (c) Check element operation and reset clock time.
(Refer to Diagnostics Section 4.3).

Base Element



Location: Below the oven cavity

Removal

- (a) Follow general servicing instructions for components in back panel area. (Refer to Section 7.3).
- (b) Remove the two largest vent ducting sections.
- (c) **For Single Ovens and Double Oven Lower Cavity**
 - i) Remove two screws on base element cover.
 - ii) Bend element cover down to clear element.
 - iii) Remove element wires.
 - iv) Remove element retaining screw.
 - v) Pull element out from under oven cavity.

Re-assembly

- i) Re-fit in reverse manner.
 - ii) Follow re-assembly procedure. (Refer to Section 7.5).
- (d) **For Double Oven Upper Cavity**
- i) Remove remaining section of vent ducting.
 - ii) Disconnect lower exhaust fan wires.
 - iii) Remove lower exhaust fan.
 - iv) Remove element wires.
 - v) Remove two screws retaining fan cover.

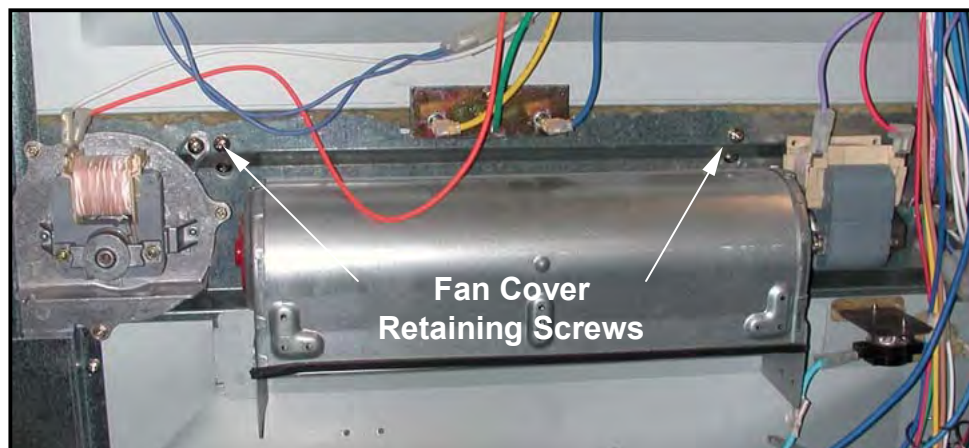
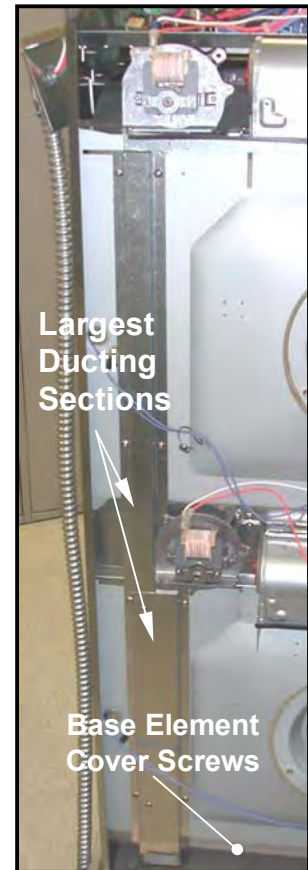

- vi) Pull fan cover upward to clear locating tabs.
- vii) Allow fan cover to drop down to clear element.
- viii) Remove element retaining screw.
- ix) Pull element out from under oven cavity.

Re-assembly

- i) Re-fit in reverse manner.

Note: When re-inserting element use a wide flat blade or similar object to lift the cavity insulation clear of the replacement element.

- ii) Follow re-assembly procedure. (Refer to Section 7.5)

7.16 Cooling Fan



Location: Back panel and top panel areas.

Removal

Follow general servicing instructions for components in back panel area. (Refer to Section 7.3)

For single ovens and upper cooling fan on double ovens.

- (a) Remove top panel
- (b) Remove wiring from cooling fan motor.
- (c) Remove two screws on left of cooling fan and slide out from locating slot.
- (d) Remove four small retaining screws for the side brackets and transfer the brackets to replacement cooling fan.

For lower cooling fan on double ovens.

- (a) Remove back panel. (Refer to Section 7.3).
- (b) Remove wiring from cooling fan motor.
- (c) Remove two screws on right of cooling fan and slide out from locating slot.
- (d) Remove four small retaining screws for the side brackets and transfer the brackets to replacement cooling fan.

Re-assembly

- (a) Re-fit in reverse order.
- (b) Follow re-assembly procedure. (Refer to Section 7.5).

7.17 Exhaust Fan



Location: In back panel area

For single ovens and upper cavity in double ovens

Removal

- (a) Follow general servicing instructions for components in back panel area. (Refer to Section 7.3)
- (b) Remove exhaust fan retaining screws.
- (c) Remove longest section of vent ducting.
- (d) Remove exhaust fan wiring and transfer to replacement fan.
- (e) Lift exhaust fan out of vent ducting and rotate counter-clockwise to clear surrounding parts.
- (f) Pull exhaust fan off vent tube.

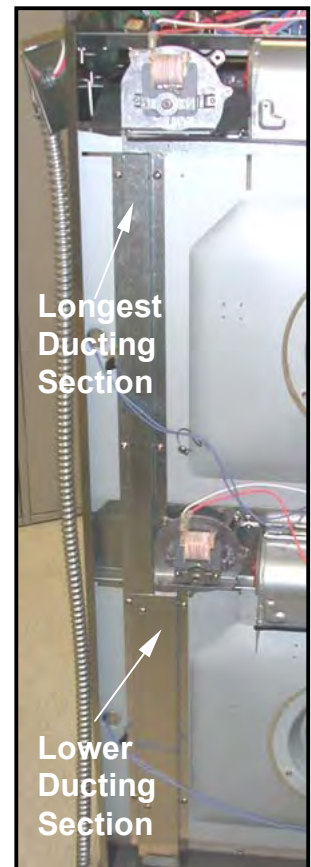

Re-assembly

- (a) Re-fit in reverse manner.
- (b) Follow re-assembly procedure. (Refer to Section 7.5).

For lower cavity in double ovens

Removal

- (a) Follow general servicing instructions for components in back panel area. (Refer to Section 7.3)
- (b) Remove exhaust fan retaining screw.
- (c) Remove lower section of vent ducting.
- (d) Remove exhaust fan wiring and transfer to replacement fan.
- (e) Pull exhaust fan off vent tube.

Re-assembly

- (a) Re-fit in reverse manner.
- (b) Follow re-assembly procedure. (Refer to Section 7.5).

7.18 Oven Cavity Fan



Location: Back panel area.

Removal

- (a) Follow general servicing instructions for components around back panel area. (Refer to Section 7.3).

Note: If the oven fan is not operating then check to see if the fan element is operating properly as the element will burn out if it has no cooling air supply.

- (b) Remove oven fan shroud. (Refer to Section 7.20).
- (c) Remove oven fan blade in oven cavity.

Note: Turn fan blade securing nut clockwise to remove (Left hand thread).

- (d) Remove three screws securing to rear insulation panel.
- (e) Disconnect wires and transfer them to replacement fan motor.
- (f) Remove fan motor from back panel.
- (g) Transfer the mounting plate to replacement fan motor.

Note: To remove mounting plate use pliers to bend holding tabs back.



Re-assembly

- (a) Re-fit in reverse manner.
- (b) Follow re-assembly procedure. (Refer to Section 7.5).

7.19 Fan Shroud

Location: Rear of oven cavity.

Removal

- (a) Remove shelves and utensils.
- (b) Remove two screws securing top of shroud.

Note: Hold the shroud when removing screws as it will fall towards you.

- (c) Pull the shroud from the two tongue slots at the bottom of the oven cavity.
- (d) The shroud can now be removed from the oven cavity.

Re-assembly

- (a) Re-fit in reverse manner.
- (b) Follow re-assembly procedure. (Refer to Section 7.5).

7.20 Oven Door

Removal

- (a) Open the oven door fully.
- (b) Pull the hinge clips on the door hinge towards you, on to the hooks.
- (c) Raise door slightly, holding on to either side near handle. Make sure that the hinge clips stay on the hooks.
- (d) Lift out the oven door and hinges.

Re-assembly

- (a) To replace door, place hinge arms into hinge slots. Push the hinges in as far as they will go.
- (b) Ensure oven door is fully open and push the hinge clips away from you.
- (c) Raise the door slightly and ensure the hinge clips are released from the hooks. Door can now be closed

7.21 Oven Door – Disassembly



To separate door inner and door outer assemblies:

- (a) Remove door from oven. (Refer to Section 7.20).
- (b) Lay door face down on table.

Note: If placing the oven door face down use foam blocks or similar to avoid marking the door surface

- (c) Remove four hinge screws on bottom edge of door and eight retaining screws down sides of door.

Note: A spare screw and washer kit can be ordered from the Parts Manual.

- (d) Lift off door inner assembly.

Door Inner Assembly:

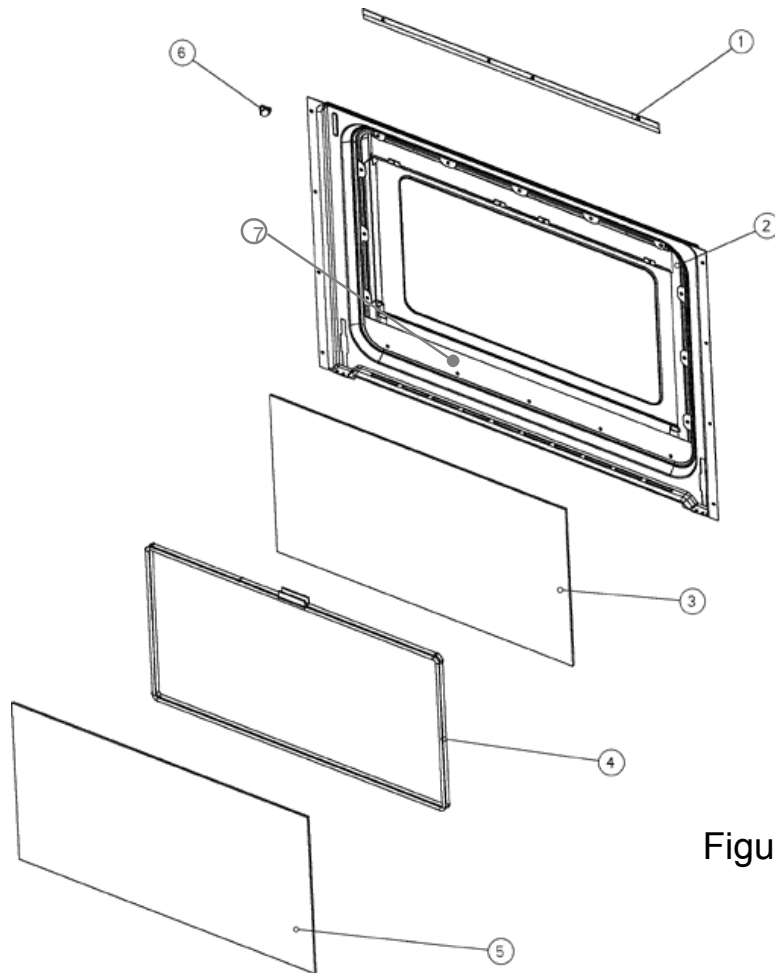
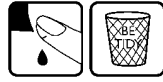

Figure A

Remove Glass Panes:

- (a) Separate door assemblies and put outer assembly to the side. (Refer Above).
- (b) On the door inner assembly remove four screws for top retaining bracket. (Fig. A Part 1)
- (c) Loosen five screws on insulation retainer panel. (Fig. A Part 7)
- (d) Slide out heat reflective glass pane (GEM96-II). (Fig. A Part 5)
- (e) Remove door inner glass pane with gasket (GEM90-TMP) (Fig. A Parts 3&4)

Note: If transferring the gasket to a replacement glass pane then ensure gasket join is located at top of door.

Note: This glass pane has a reflective coating on only one side. Ensure that the coating is facing the oven cavity when re-assembled.

Note: To test if a glass pane has a heat reflecting coating use an ohmmeter to test for continuity on the glass surface. If there is continuity then the glass is coated.

Re-assembly

- (a) Re-assemble in reverse manner.

Note: Clean glass before re-assembly.

Door Outer Assembly:

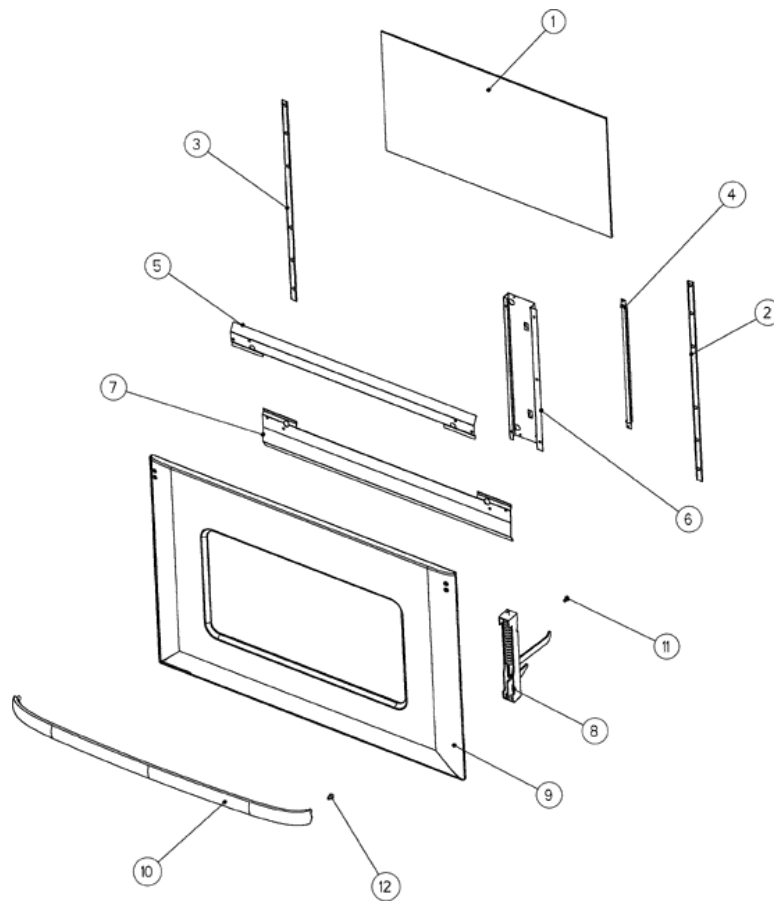
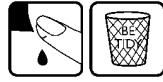

Figure B

Remove Handle:

- (a) Separate door assemblies and put inner assembly to the side. (Refer above).
- (b) Remove four countersunk screws in top corners of door outer assembly. Handle will drop down. (Fig. B Part 10 & 12)

Re-assembly

- (a) Re-fit in reverse manner.

Remove Inner Glass:

- (a) Separate door assemblies and put inner assembly to the side. (Refer above).
- (b) Remove four screws securing the heat shield panel. (Fig. B Part 5)
- (c) Loosen four screws securing the bottom flow guide panel. (Fig. B Part 7)
- (d) Slide heat reflective glass pane out from bottom flow guide panel (GEM96-11). (Fig. B Part 1)

Re-assembly

- (a) Re-fit in reverse manner.

Remove door hinge:

- (a) Separate door assemblies and put inner assembly to the side. (Refer previous).
- (b) Remove heat reflective glass pane. (Fig. B Part 1)

- (c) Loosen two inner screws on outer door glass bracket and remove three screws down side of bracket. (Fig. B Part 6)
- (d) Slide the outer door glass bracket clear of the hinge stanchion.
- (e) Remove door hinge retaining screw near top of stanchion. (Fig. B Part 11)
- (f) Lift door hinge and hinge stanchion enough to clear edge of door cap. (Fig. B Part 9).

Caution: Inner edges of stainless steel door cap are very sharp.

- (g) Pull faulty door hinge out from hinge stanchion. (Fig. B Part 8)

Re-assembly

- (a) Re-fit in reverse manner.

Note: If hinge arm is unclipped use an adjustable spanner to load up hinge spring and clip hinge arms down.



7.22 Meat Probe Socket



Location: Near oven cavity opening on left-hand side.

Removal

- (a) Disconnect unit from power supply.
- (b) Remove meat probe socket inspection panel.
- (b) Remove socket retaining nut inside oven cavity.
- (c) Pull meat probe socket through inspection hole.
- (d) Cut wires to faulty socket.
- (e) Cut and strip wires from replacement socket as shown.
- (f) Connect old wires to replacement socket using ceramic connector blocks or high temp wire connectors.



Re-assembly

- (g) Re-fit in reverse manner.

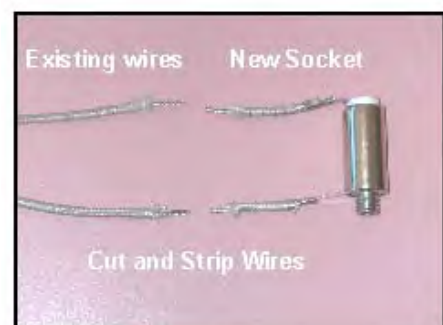

7.23 Oven Door Lock Assembly

Location: Behind left hand side panel.

Lock Jammed

- (a) If door lock is engaged and door cannot be removed then refer to following procedures.

- (b) Remove front door lock inspection panel.
- (c) Remove link pin cir-clip and disconnect link arm.

Note: Take care not to lose the link pin cir-clip or pin. The door lock should now be free to disengage. A lock assembly spare parts kit is available from the Parts Manual.



- (d) If door lock needs replacing refer to following.

Removal

- (a) Follow general servicing instructions for components around back panel and service panel areas. (Refer to Sections 7.3 & 7.4).
- (b) Remove door switch and motor wiring harnesses from power module and disconnect two wires from the isolating relay. (Refer to Section 5.25 for photo showing switch positions.)

Note: Ensure isolating relay wires are plugged into power module connector when reassembling.

- (c) Remove front and rear door lock assembly retaining screws.
- (d) Remove wire connector from door switch. (This is only necessary for the upper door lock on a double oven.)
- (e) Pull door lock assembly out from side panel.

Note: Be careful not to lose door switch spring when pulling lock assembly out.

Re-assembly

- (a) Re-fit in reverse manner.
- (b) Follow re-assembly procedure. (Refer to Section 7.5)

7.24 Component Location Guide

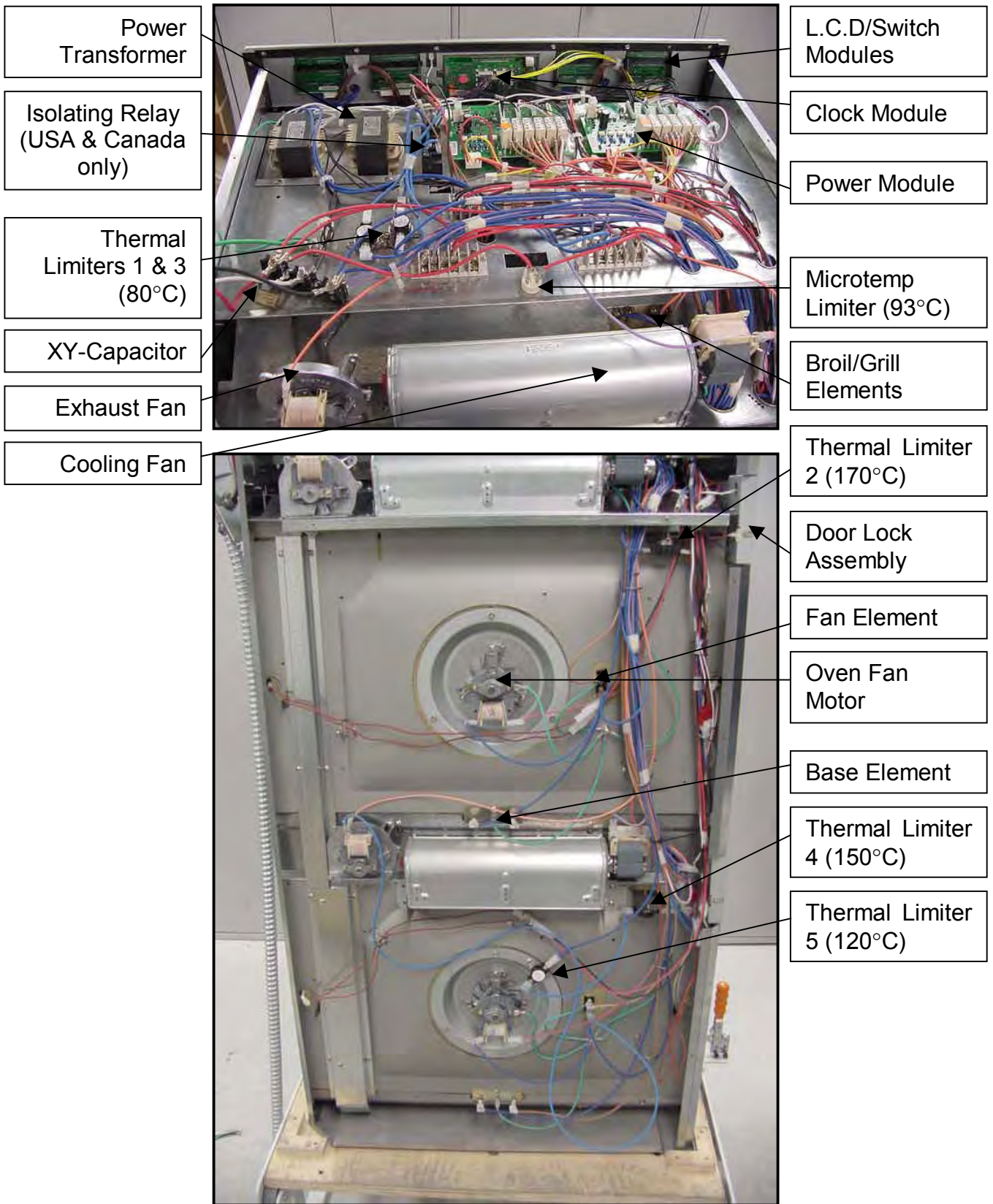

NOTES