



Service

This manual is to be used by qualified appliance technicians only. Maytag does not assume any responsibility for property damage or personal injury for improper service procedures done by an unqualified person.

Freestanding Electric Range Export

This Base Manual covers general information

Refer to individual Technical Sheet
for information on specific models

This manual includes, but is
not limited to the following:

CER3725AGW
CER4351AGW

MAYTAG®

16026839
Replaces 16026308
January 2006
© 2006 Maytag Services

Important Information

Pride and workmanship go into every product to provide our customers with quality products. It is possible, however, that during its lifetime a product may require service. Products should be serviced only by a qualified service technician who is familiar with the safety procedures required in the repair and who is equipped with the proper tools, parts, testing instruments and the appropriate service information. **IT IS THE TECHNICIANS RESPONSIBILITY TO REVIEW ALL APPROPRIATE SERVICE INFORMATION BEFORE BEGINNING REPAIRS.**

Important Notices for Servicers and Consumers



WARNING

To avoid risk of severe personal injury or death, disconnect power before working/servicing on appliance to avoid electrical shock.

To locate an authorized servicer, please consult your telephone book or the dealer from whom you purchased this product. For further assistance, please contact:

Customer Service Support Center

CAIR Center

Web Site

WWW.MAYTAG.COM

Telephone Number

1-800-688-9900

Recognize Safety Symbols, Words, and Labels



DANGER

DANGER—Immediate hazards which **WILL** result in severe personal injury or death.



WARNING

WARNING—Hazards or unsafe practices which **COULD** result in severe personal injury or death.



CAUTION

CAUTION—Hazards or unsafe practices which **COULD** result in minor personal injury, product or property damage.

Table of Contents

Important Information	2	Testing Procedures	
Important Safety Information		Component Testing Procedures	12
Safety Practices for Servicer	4	Quick Test Mode	14
Servicing	4	Disassembly Procedures	
Electrical Requirements	5	Removing and Replacing Oven	16
Extension Cord	5	Maintop Assembly	16
Receiving Oven	5	Control Panel	16
Using the Oven	5	Control Board Assembly	16
Baking, Broiling, and Roasting	5	Infinite Switch	16
Surface Cooking Units	6	Indicator Lights	16
Ovens	6	Rocker Switch	16
Self-Cleaning Ovens	6	Oven Sensor	16
Glass/Ceramic Cooking Surfaces	6	Bake Element	16
Ventilating Hoods	6	Broil Element	17
Precautions	6	Ribbon Elements	17
Product Safety Devices	6	Oven Door Removal	17
General Information		Oven Door Hinge Receiver	17
Cooking Nomenclature	7	Side Panel Removal	17
Specifications	8	Backguard	17
Placement of the Oven	8	Storage Drawer Removal	17
Do Not Block Air Vents	8	Storage Drawer Track Removal	17
Location of Model Number	8	Oven Light Assembly	18
Grounding Instructions	8	Door Disassembly	18
Model Identification	8	Appendix A	
Service	8	Installation Instructions	A-2
Parts and Accessories	8	Appendix B	
Extended Service Plan	8	Use and Care Instructions	B-2
Range Description	9	Care and Cleaning Instructions	B-6
Troubleshooting Procedures	10		

Important Safety Information

Recognize this symbol as a safety precaution.



WARNING

If the information in this manual is not followed exactly, a fire or explosion may result causing property damage, personal injury or death.

There can be a risk of injury or electrical shock while performing services or repairs. Injury or electrical shock can be serious or even fatal. Consequently, extreme caution should be taken when performing voltage checks on individual components of a product. The electrical power supply should ALWAYS be disconnected when servicing a product.

This appliance must be properly grounded. Never plug in or direct-wire an appliance unless it is properly grounded and in accordance with all local and national codes. See "Installation Instructions" that accompany the product for the appropriate grounding procedures.

GROUND PATH SPECIFICATIONS:

Ground Path Resistance: 0.1 ohms maximum
Insulation Resistance: 250k ohms minimum

WARNING

To avoid risk of electrical shock, property damage, personal injury or death; verify wiring is correct, if components were replaced. Verify proper and complete operation of unit after servicing.

This appliance contains or produces a chemical or chemicals which are known to the state of California to cause cancer, birth defects or other reproductive harm. To reduce the risk from substances in the fuel or from fuel combustion, make sure this appliance is installed, operated, and maintained according to the instructions in this manual.

TO REDUCE THE RISK OF TIPPING OF THE RANGE, THE RANGE MUST BE SECURED BY PROPERLY INSTALLED ANTI-TIP DEVICES.

WARNING

In Case of Fire

Fires can occur as a result of over cooking or excessive grease. Though a fire is unlikely, proceed as follows:

Surface Element Fires

1. Smother fire with a nonflammable lid/baking soda, or use a Class ABC or BC extinguisher. Not water, salt or flour.
2. As soon as it is safe to do so, turn the surface controls to "OFF."

Oven Fires

1. Do not open the oven door.
2. Turn all controls to the OFF position.
3. As an added precaution turn off the electricity at the main circuit breaker or fuse box.
4. Turn on vent to remove smoke.
5. Allow the food or grease to burn itself out in the oven.
6. If smoke and fire persist, call the local fire department.
7. If there is any damage to components, call an authorized servicer before using range.

To avoid risk of property damage or personal injury, do not obstruct the flow of combustion or ventilation air to the oven.

To avoid risk of electrical shock, serious personal injury or death: Verify the oven has been properly grounded and always disconnect the electrical supply before servicing this unit.

Safety Practices for Servicer

Safe and satisfactory operation of electrical ranges depends upon its design and proper installation.

Servicing

Listed below are some general precautions and safety practices which should be followed in order to protect the service technician and consumer during service and after service has been completed.

1. **Check range when service is complete**—After servicing, make visual checks on electrical connection. Inform consumer of the condition of range before leaving.
2. **Adhere to all local regulations and codes when performing service.**

Important Safety Information

Electrical Requirements

400/230-volt, 3-Phase, 50/60 Hertz, 16 amp per phase, individual circuit which is properly grounded, polarized and protected by a circuit breaker or fuse.

Extension Cord

Due to possible pinching during installation, extension cords should not be used on products.

Receiving Oven

- Authorized servicer must install the range, in accordance with the Installation Instructions. Adjustments and service should be performed only by authorized servicer.
- Plug range into a 400/230-volt, five-wire grounded outlet only. Do not remove round grounding prong from the plug. If in doubt about grounding of the home electrical system, it is the consumers responsibility and obligation to have an ungrounded outlet replaced with a properly grounded three-prong outlet in accordance with the National Electrical Code. Do not use an extension cord with this appliance.
- Insure all packing materials are removed from the range before operating it, to prevent fire or smoke damage should the packing material ignite.
- With prolonged use of a range, high floor temperatures could result. Many floor coverings will not be able to withstand this kind of use. Never install range over vinyl tile or linoleum that cannot withstand high temperatures. Never install range directly over carpeting.

Using the Oven

- Do not leave children alone or unattended where a range is hot or in operation. They could be seriously burned.
- Do not allow anyone to climb, stand or hang on the door. They could damage the range and cause severe personal injury.
- Wear proper apparel. Loose fitting or hanging garments should never be worn when using oven. Flammable material could ignite if brought in contact with hot oven surfaces which may cause severe burns.
- Never use range for warming or heating a room. This may cause burns, injuries, or a fire.
- Do not use water on grease fires.
- Do not let grease or other flammable materials collect in or around range.
- Do not repair or replace any part of range unless it is recommended in this manual.
- Use only dry potholders. Moist or damp potholders used on hot surfaces may result in a burn from steam. Do not use a towel or a bulky cloth as a potholder.
- Never leave range unattended while cooking. Boilovers can cause smoking and may ignite.

- Only certain types of glass/ceramic, earthenware, or other glazed utensils are suitable for oven use. Unsuitable utensils may break due to sudden temperature change.
- Use care when opening oven door. Let hot air or steam escape before removing or replacing food.
- Do not heat unopened food containers in oven. Buildup of pressure may cause a container to burst and result in injury.
- Keep range vent ducts unobstructed.
- Place oven racks in desired location while oven is cool. If a rack must be moved while oven is hot, use a dry potholder.
- Do not use aluminum foil to line oven bottom or racks. Aluminum foil can cause a fire and will seriously affect baking results, and damage to porcelain surfaces.
- Do not touch interior surfaces of oven during or immediately after use. Do not let clothing or other flammable materials come in contact with bake or broil elements.
- Other areas of the oven can become hot enough to cause burns, such as vent openings, window, oven door and oven racks.
- To avoid steam burns, do not use a wet sponge or cloth to wipe up spills on hot cooking area.
- Do not store combustible or flammable materials, such as gasoline or other flammable vapors and liquids near or in oven.
- Do not clean oven door gasket located on back of the door. Gasket is necessary to seal the oven and can be damaged as a result of rubbing or being moved.
- Do not drape towels or any materials on oven door handles. These items may ignite causing a fire.



CAUTION

Do not store items of interest to children in cabinets above range. Children may climb on oven to reach these items and become seriously injured.

Baking, Broiling, and Roasting

- Do not use oven area for storage.
- Stand back from range when opening a hot oven door. Hot air or steam can cause burns to hands, face, and eyes.
- Use only glass cookware appropriate for use in electric ovens.
- Always remove broiler pan from oven when finished broiling. Grease left in pan can catch fire if oven is used without removing grease from the broiler pan.
- Make sure broiler pan is placed correctly to reduce any possibility of grease fires.
- Should a grease fire occur in the broiler pan, turn off oven, and keep oven door closed until fire burns out.

Important Safety Information

Surface Cooking Units

1. Use Proper Pan Size—This appliance is equipped with one or more surface units of different size. Select utensils having flat bottoms large enough to cover the surface unit heating element. The use of undersized utensils will expose a portion of the heating element to direct contact and may result in ignition of clothing. Proper relationship of utensil to burner will also improve efficiency.
2. Never Leave Surface Units Unattended—Boilover causes smoking/greasy spillovers that may ignite.
3. Make Sure Reflector Pans or Drip Bowls Are In Place—Absence of these pans or bowls during cooking may subject wiring or components underneath to damage.
4. Protective Liners—Do not use aluminum foil to line oven bottom. Improper installation of these liners may result in a risk of electrical shock or fire.
5. Glazed Cooking Utensils—Do not use glass, ceramic, earthenware or other glazed utensils. They can damage or break smoothtop due to sudden change in temperature.
6. Utensil Handles Should be Turned Inward and Not Extend Over Adjacent Surface Units—To reduce the risk of burns, ignition of flammable materials, and spillage due to unintentional contact with the utensil, the handle of a utensil should be turned inward, and does not extend over adjacent surface units.
7. Do Not Soak Removable Heating Elements—Heating elements should never be immersed in water.

Ovens

1. Use Care When Opening Door—Let hot air or steam escape before removing or replacing food.
2. Do Not Heat Unopened Food Containers—Buildup of pressure may cause container to burst and result in injury.
3. Keep Oven Vent Ducts Unobstructed.
4. Placement of Oven Racks—Always place oven racks in desired location while oven is cool. If rack is removed while oven is hot, do not let potholder contact hot heating element in oven.

Self-Cleaning Ovens

1. Do Not Clean Door Gasket—The door gasket is essential for a good seal. Care should be taken not to rub, damage or move the gasket.
2. Do Not Use Oven Cleaners—No commercial oven cleaner or oven liner protective coating of any kind should be used in or around any part of the oven.
3. Clean Only Parts Listed in Manual.
4. Before Self-Cleaning the Oven—Remove broiler pan and other utensils.

Glass/Ceramic Cooking Surfaces

1. Do Not Cook on Broken Cooktop—If cooktop should break, cleaning solutions and spillovers may penetrate the broken cooktop and create a risk of electric shock. Contact a qualified technician immediately.
2. Clean Cooktop with Caution—If a wet sponge or cloth is used to wipe spills on a hot cooking area, be careful to avoid steam burn. Some cleaners can produce noxious fumes if applied to a hot surface.

Ventilating Hoods

1. Clean Ventilating Hoods Frequently—Grease should not be allowed to accumulate on hood or filter.
2. When flaming foods under the hood, turn the fan off. The fan, if operating, may spread the flame.

Precautions

- Do not cook food directly on range top surface, always use cookware.
- Do not mix household cleaning products. Chemical mixtures may interact with hazardous results.
- Do not put plastic items on warm cooking areas.
- Do not slide rough objects across range top surface.
- Do not leave fat heating unless you remain nearby. Fat can ignite if overheated by spilling onto hot surfaces.
- Do not allow pots to boil dry as this can cause damage to cooking surface and pan.
- Do not use range top surface as a cutting board.

Product Safety Devices

Safety devices and features have been engineered into the product to protect consumer and servicer. Safety devices must never be removed, bypassed, or altered in such a manner as to defeat the purpose for which they were intended.

Grounded Oven Frame

Ground prong on power cord is connected to the frame, usually a green lead fastened by a screw. Any part or component capable of conducting an electric current is grounded by its mounting.

If any ground wire, screw, strap, nut, etc. is removed for service, it must be reconnected to its original position with original fastener before the range is put into operation. Failure to do so can create a possible shock hazard.

General Information

This manual provides basic instructions and suggestions for handling, installing and servicing electric ranges.

The directions, information, and warnings in this manual are developed from experience and careful testing of the product. If the unit is installed according to this manual, it will operate properly and will require minimal servicing. A unit in proper operating order ensures the consumer all the benefits provided by clean, modern electric cooking.

This manual contains information needed by authorized service technicians to install and service electric ranges.

There may be, however, some parts which need further explanation. Refer to the Installation Instructions, Use and Care, Technical Sheets or the toll-free technical support line.

Cooking Nomenclature

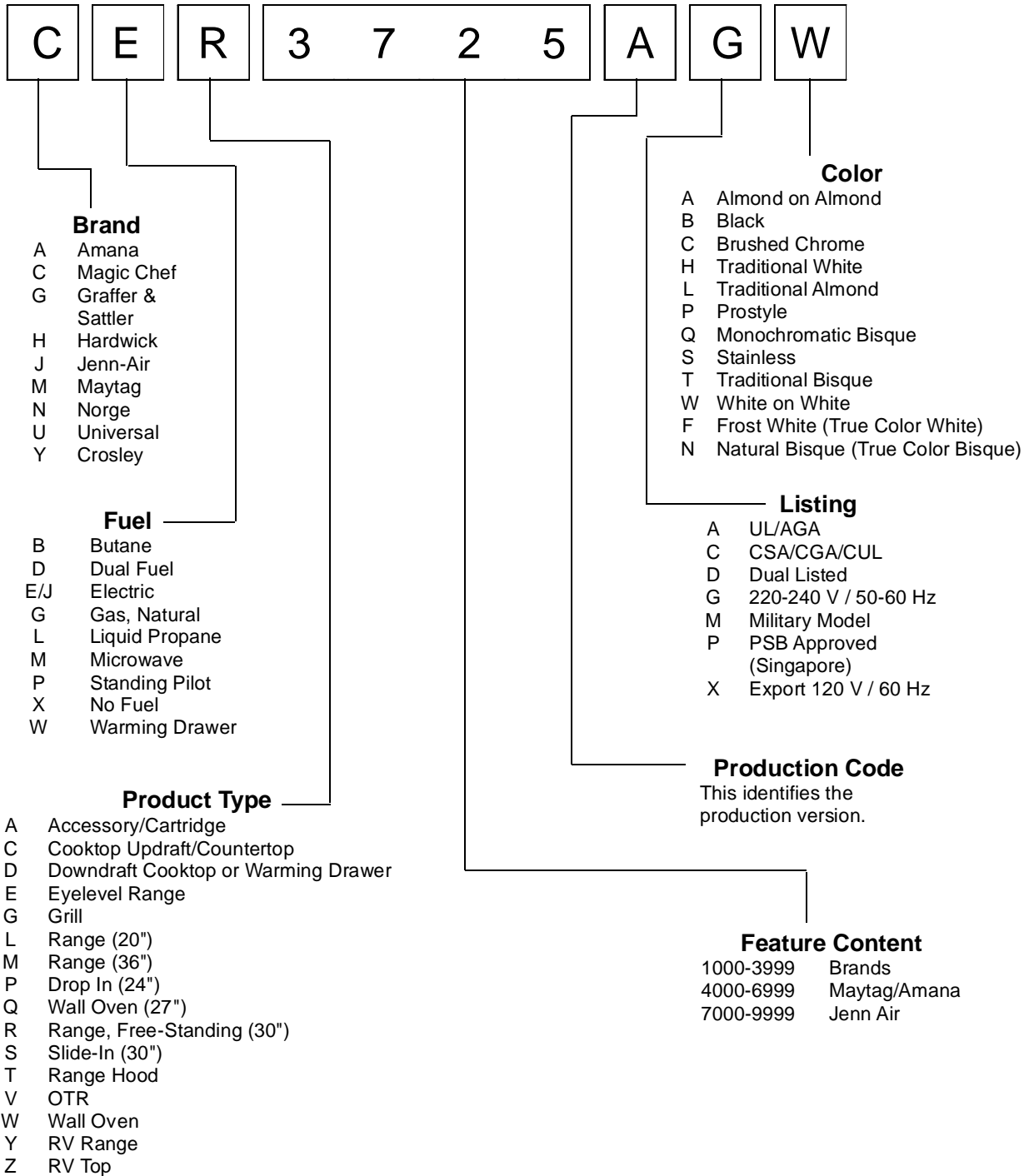

General Information

Specifications

Refer to individual Technical Sheet for specification information.

Placement of the Oven

This freestanding range must be placed in the kitchen or comparable room. All safety guidelines must be followed and free air flow around the range is essential.

Do Not Block Air Vents

All air vents must be kept clear during cooking. If air vents are covered during operation, the oven may overheat. If this occurs, a sensitive, thermal safety device automatically removes power to the oven, rendering the oven inoperable. The oven will remain in this state until it has sufficiently cooled.

Location of Model Number

To request service information or replacement parts, the service center will require the complete model, serial, and manufacturing number of your freestanding range. The number can be found on the oven chassis behind the service drawer. Open the service drawer to view the data.

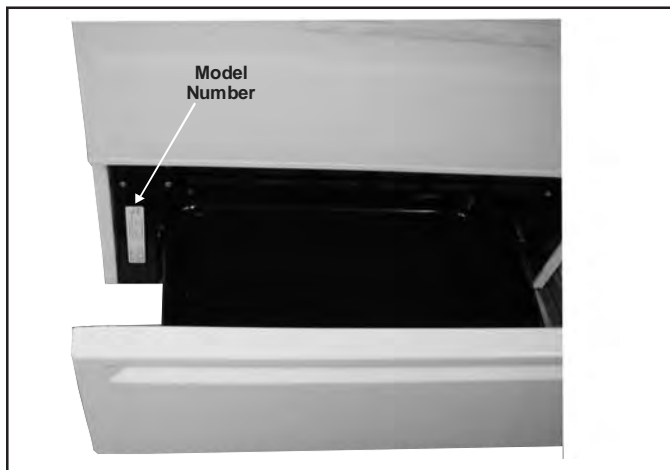

Grounding Instructions

This appliance must be grounded. If an electrical short circuit occurs, grounding reduces the risk of electric shock by providing an escape wire for the electric current. The cord for this appliance has a grounding wire with a grounding plug. Put the plug into an outlet that is properly installed and grounded.

 **WARNING**

To avoid risk of electric shock, personal injury or death, use grounding plug properly.

Ask a qualified electrician if you do not understand the grounding instructions or if you wonder whether the appliance is properly grounded. Keep the electrical power cord dry and do not pinch or crush it in any way.

For a permanently connected appliance: This appliance must be connected to a grounded, metallic, permanent wiring system, or an equipment grounding conductor should be run with the circuit conductors and connected to the equipment grounding terminal or lead on the appliance.

 **WARNING**

Attaching adapter ground terminal to wall receptacle cover screw does not ground appliance unless the cover screw is metal and not insulated, and wall receptacle is grounded through the house wiring. Consumer should have circuit checked by a qualified electrician to verify receptacle is properly grounded.

Model Identification

Complete enclosed registration card and promptly return. If registration card is missing:

- For Maytag product call 1-800-688-9900 or visit the Web Site at www.maytag.com

When contacting provide product information located on rating plate. Record the following:

Model Number: _____
Manufacturing Number: _____
Serial or S/N Number: _____
Date of purchase: _____
Dealer's name and address: _____

Service

Keep a copy of sales receipt for future reference or in case warranty service is required. To locate an authorized servicer:

- For Maytag product call 1-800-688-9900 or visit the Web Site at www.maytag.com

Warranty service must be performed by an authorized servicer. We also recommend contacting an authorized servicer, if service is required after warranty expires.

Parts and Accessories

Purchase replacement parts and accessories over the phone. To order accessories for your product call:

- For Maytag product call 1-800-462-9824 or visit the Web Site at www.maytag.com

Extended Service Plan

We offer long-term service protection for this new range.

- Dependability PlusSM Extended Service Plan is specially designed to supplement Maytag's strong warranty. This plan covers parts, labor, and travel charges. Call 1-800-925-2020 for information.

Range Description

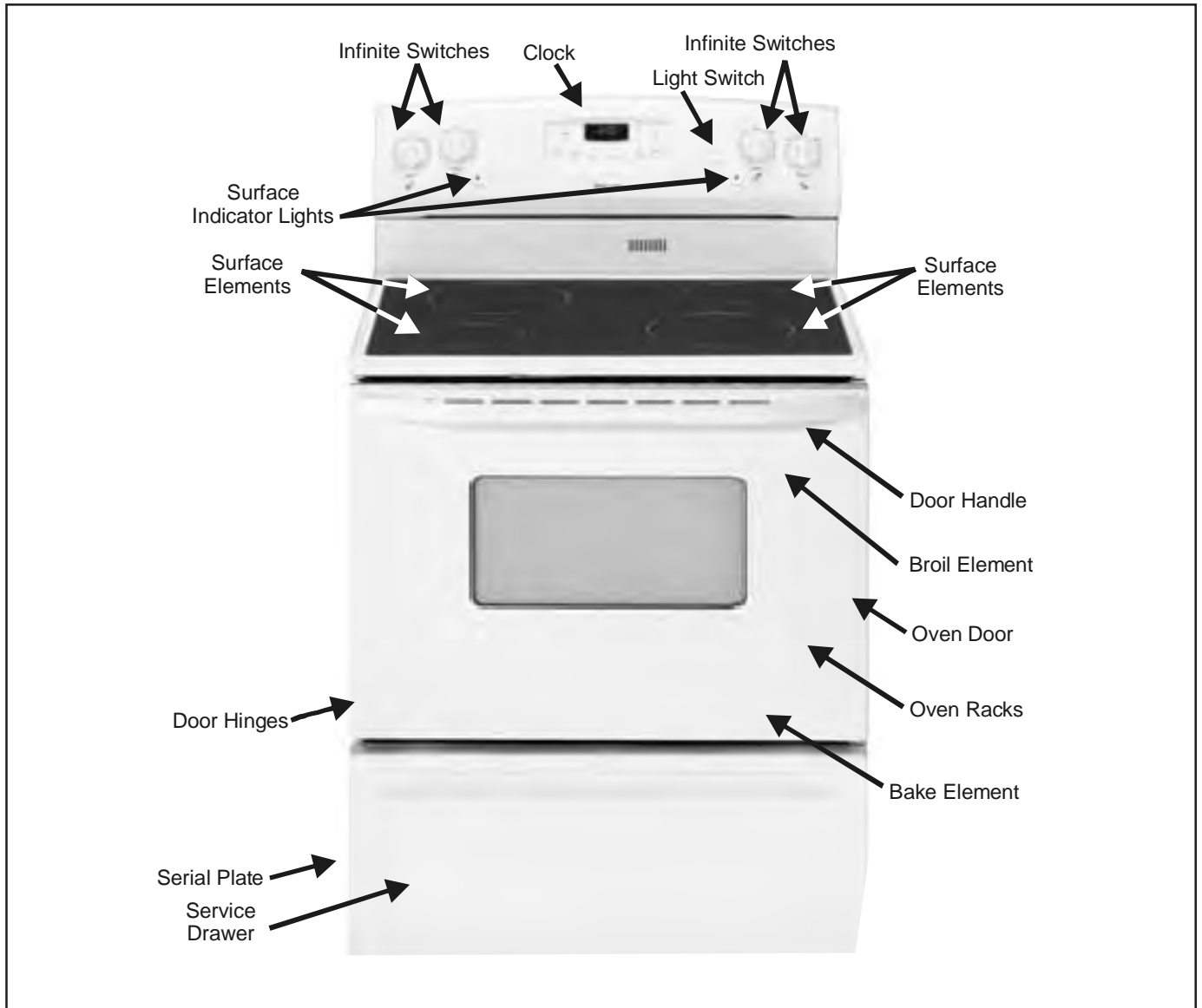

Troubleshooting Procedures



To avoid risk of electrical shock, personal injury, or death, disconnect power to range before servicing, unless testing requires power.

Problem	Possible Cause	Correction
No bake element operation	Open bake element..... Loose wire connection or broken wire	<ul style="list-style-type: none"> • Check element for continuity, replace if failed. • Verify all connections are clean and tight, replace broken wire.
No broil element operation	Open broil element..... Loose wire connection or broken wire	<ul style="list-style-type: none"> • Check element for continuity, replace if failed. • Verify all connections are clean and tight, replace broken wire.
Oven not operating	Programming error..... Power outage.....	<ul style="list-style-type: none"> • Shut off power to range for five minutes by switching circuit breaker off. Reset circuit breaker and try oven again. • Verify power is present at unit. Verify that the circuit breaker is not tripped. • Replace household fuse, but do not fuse capacity.
Clock and timer not working	Power outage.....	<ul style="list-style-type: none"> • Verify power is present at unit. Verify that the circuit breaker is not tripped. • Replace household fuse, but do not fuse capacity. • Refer to Use and Care Manual "Operating Instructions," if continues contact service.
Oven light does not operate	Failed oven lamp..... Failed wiring..... Failed light socket	<ul style="list-style-type: none"> • Check lamp and replace is necessary. • Check for broken, loose or dirty connections. • Check light socket for continuity.
Self-clean cycle not working	Programming error.....	<ul style="list-style-type: none"> • Shut off power to oven for five minutes by switching off circuit breaker. Reset circuit breaker and try oven again.
Oven door will not unlock	Oven is self-cleaning..... Oven is still hot.....	<ul style="list-style-type: none"> • Allow cycle to complete. • Will not unlock until unit has cooled to safe temperature. Do not force door open, this will void warranty. Blow cool air on door latch area to quicken process.
Oven smokes/odor first few times of usage	Normal.....	<ul style="list-style-type: none"> • Minor smoking or odor is normal the first few times of oven usage. • Ventilate area well and perform self-clean cycle.
Failure Codes	Electronically Controlled	<ul style="list-style-type: none"> • Refer to specific Technical Sheet for diagnostic checks.

Troubleshooting Procedures



WARNING

To avoid risk of electrical shock, personal injury, or death, disconnect power to range before servicing, unless testing requires power.







Problem	Possible Cause	Correction
Surface element does not heat	Open element Loose wire connection or broken wire Failed infinite switch.....	<ul style="list-style-type: none"> • Check element for continuity, replace if failed. • Verify all connections are clean and tight, replace broken wiring. • Check infinite switch, replace if failed.
Frequent cycling of surface element or warming zone	Normal	<ul style="list-style-type: none"> • Element cycles to maintain proper heat and to prevent damage to cooking surface.

Component Testing Procedures

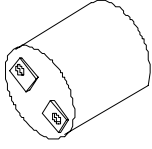
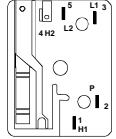
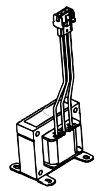

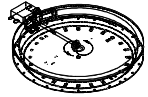
WARNING

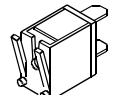
To avoid risk of electrical shock, personal injury or death; disconnect power to range before servicing, unless testing requires power.

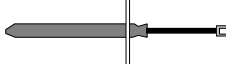
Illustration	Component	Test Procedure	Results
	Oven light socket	Remove one wire from receptacle and test resistance of terminals..... Measure voltage at oven light	Indicates continuity with bulb inserted. 220 - 240 VAC, see wiring diagram for terminal identification. If voltage is not present at oven light, check wiring or light switches.
	Push-to-turn infinite switch	Connect Volt-ohms meter to H1 and H2. Measure the following for voltages at LO, MED, HI: H1 to H2	Approximate Time On Time Off LO 5% 95% MED (4-5) 35% 65% HI 100% 0% 220 - 240 VAC. If not, replace switch.
	Step-down transformer RED 3 220/240 VOLT PRIMARY BLACK 1 STEP-DOWN TRANSFORMER SCHEMATIC 110/220 VOLT SECONDARY 2 WHITE	Measure voltage: Primary terminals..... Secondary terminals	220 - 240 volts 110 - 120 volts
	Bake element	Measure voltage at bake element	220 - 240 VAC, see wiring diagram for terminal identification. If voltage is not present at bake element, check wiring. Approximately 21.7 Ω.
	Broil element	Measure voltage at broil element	220 - 240 VAC, see wiring diagram for terminal identification. If voltage is not present at broil element, check wiring. Approximately 18.7 Ω.
	Ribbon element 1200W	Measure voltage at coil element..... Disconnect wire leads to element and measure resistance of terminals	220 - 240 VAC, see wiring diagram for terminal identification. If voltage is not present at element, check wiring. Approximately 44 to 49 Ω.
	Ribbon element 2500W	Measure voltage at coil element..... Disconnect wire leads to element and measure resistance of terminals	220 - 240 VAC, see wiring diagram for terminal identification. If voltage is not present at element, check wiring. Approximately 21 to 24 Ω.
	Oven indicator light and Surface indicator light	Measure voltage at indicator light.....	If voltage is present and light does not work, replace light. If voltage is not present at indicator light, check wiring.
	Rocker switch	Measure continuity of switch positions: Closed	Continuity Infinite
	Oven temperature sensor	Measure resistance.....	Approximately 1050 to 1100 Ω at room temperature 80° F.

Component Testing Procedures



WARNING

To avoid risk of electrical shock, personal injury or death; disconnect power to range before servicing, unless testing requires power.

Illustration	Component	Test Procedure	Results
NSC Controlled	Oven Temperature Adjustment	<p>Press Bake pad. Enter 550 on the digit-pad. Immediately press and hold Bake pad for 3 to 5 seconds.</p> <p>Oven can be adjusted from -35 to +35 degrees in 5-degree increments by pressing Up or Down Arrow pads. To avoid over adjusting the oven, move temperature 5 degrees each time. Wait 4 seconds for the data entry timer to expire to accept the change. Temperature adjustment will be retained even through a power failure.</p>	While increasing or decreasing oven temperature, this does not affect self-cleaning temperature.
NSC Controlled	Keypad Lockout	Press and hold Cancel and Timer pads for 3 to 5 seconds. Press Up or Down Arrow pads to change.	This mode disables keypad input to deter against accidental keypad entries.
NSC Controlled	Temperature Display	Press and hold Cancel and Bake pads for 3 to 5 seconds. Press Up or Down Arrow pads to change.	This mode enables the user to indicate °F or °C on the display.
NSC Controlled	Sabbath Mode	<p>Hold Clock pad for 3 to 5 seconds to activate Sabbath mode.</p> <p>Hold Clock pad for 3 to 5 seconds to disable Sabbath mode.</p> <p>Desired bake function must be initiated before entering Sabbath mode.</p>	"SAb" flashes for 5 seconds, then remains on until timed-out or cancelled. The status "SAb" is NOT fault code 5A6. All pad inputs are disabled except for CANCEL and CLOCK pads. This mode disables the normal 12 hour shutoff to allow operation of the bake mode for a maximum of 72 hours. The oven light is not disabled.
NSC Controlled	Twelve Hour Off	Control will automatically cancel any cooking operation and remove all relay drives 12 hours after the last pad touch.	See Sabbath mode to disable.
NSC Controlled	Diagnostic Code Display	<p>Press and hold Up Arrow pad for 3 to 5 seconds when applying power to the unit.</p> <p>Cycle through the codes using the Up or Down Arrow pads.</p>	<p>The last 5 diagnostic codes will be stored in the non-volatile memory.</p> <p>See "Description of Error Codes" for explanation.</p>
NSC Controlled	One-Watt Standby Mode	Press and hold Cancel and Down Arrow pads for 3 to 5 seconds.	After 15 idle minutes, the control automatically enters this mode. The LED display remains active.

Component Testing Procedures



WARNING

To avoid risk of electrical shock, personal injury or death; disconnect power to range before servicing, unless testing requires power.

"Quick Test" Mode for Non-Self Clean Control

Follow procedure below to use the quick test mode. Entries must be made within 32 seconds of each other or the control will exit the quick test mode.

1. **Press and hold *Cancel* and *Broil*** keypads for 3 to 5 seconds within 5 minutes of applying power.
2. Once the control has entered the "Quick Test" mode, release both keypads.
3. Press each of the following keypads indicated in the table below.

NOTE: Press the keypad once to activate the response.
Press the keypad a second time to deactivate the response.

Display will indicate the following:

Keypad	Operation
[Bake]	Bake relay activated
[Broil]	Broil relay activated
[Timer]	DLB relay activated
[Clock]	Alternate between ODD LED SEGMENTS and EVEN LED SEGMENTS on each key press
[Up Arrow]	EEPROM version number
[Down Arrow]	Code version number
[Cancel]	Exit Factory Test Mode

Description of Error Codes

Error diagnostic codes can only be viewed by entering the Diagnostic Code Display Mode. Each error code consists of four digits and each digit is described in the following table.

Digit	Description
1 st	Primary System: 1 – Local to the control circuit board 3 – Sensor and/or meat probe 4 – Control input
2 nd	Measurable: d – Diagnostic: measurable parameter c – Control related, replace control
3 rd	Secondary System: Sequential numbering
4 th	Oven Cavity: 1 – Oven c – Control specific

Component Testing Procedures



WARNING

To avoid risk of electrical shock, personal injury or death; disconnect power to range before servicing, unless testing requires power.

Diagnostic Code Checking

Code	Description	When Checked	Detection
1c1c	Shorted key	Always	1 minute
1c31	Cancel key circuit problem	Always	1 minute
1c4c	Micro communication failure	Serial communications	5 tries
1c5c	Vcc or ground	Cook active	1 minute
1c6c	EEPROM error	Cook active	5 tries
1c7c	Control not calibrated	Always	5 seconds
1c8c	Cooking program error	Cook active	5 tries
1d11	Runaway temp	Always	5 seconds
3d11	Sensor open	Cook active	5 seconds
3d21	Sensor shorted	Cook active	5 seconds

Diagnostic Code Handling

Code	Measurable	What is Displayed	Action Taken By Control
1c1c	Keypress	Nothing	Disables affected key Disables audible for affected key depression
1c31	Cancel key input, A/D out of range	Nothing	Disables all outputs ¹
1c4c	Checksum invalid	Nothing	Disables all outputs ¹
1c5c	Vcc/ground at test point	Nothing	No action
1c6c	EEPROM error	Nothing	Disables all outputs ¹
1c7c	Calibration value out of range	Nothing	No action
1d11	Sensor resistance > 640° F (337° C)	Nothing	Return to idle; disables all outputs ¹
3d11	Sensor resistance	BAKE flashes ²	Disables all cooking functions
3d21	Sensor resistance	BAKE flashes ²	Disables all cooking functions

NOTES:

¹ "Action Taken" applies as long as the condition exists. If the condition clears, the control recovers.

² Flash rate: 0.2 seconds on, 0.1 second off. Pressing any key clears the display until the fault clears and is re-triggered.

Disassembly Procedures



To avoid risk of electrical shock, personal injury or death; disconnect power to unit before servicing, unless testing requires power.

Removing and Replacing Oven

1. Turn off power to the oven at the circuit breaker.
2. Pull the oven forward out of the cabinet opening.
3. Disconnect or unplug the power cord leading from unit to fuse box or junction box depending on unit.
4. Replace the oven using the installation instructions and anti-tip bracket(s).

Maintop Assembly

1. Turn power off.
2. Open oven door and remove screws securing maintop to oven chassis, located on the outside edges of the maintop.
3. Raise the front edge of the maintop and pull forward approximately 6-inches.
4. Label and disconnect wire terminal plugs from the maintop assembly.
5. Lift maintop assembly from the oven chassis.
6. Reverse procedure to reinstall maintop assembly.

Control Panel

1. Remove maintop assembly, see "Maintop Assembly" procedure.
2. Remove screws securing control panel heat shield.
3. Remove screws securing bottom outside edges of the control panel.
4. Pull unit out from the wall far enough to allow the back outside screws to be loosened.
5. Loosen the back outside screws securing control panel to backguard.
6. Grasp front lower outside edges of the control panel and push inward on the outside edges of the backguard to release the control panel front.

NOTE: Front edges of the control panel are difficult to release from backguard.

7. Once the control panel bottom edges are free, pull control panel forward and raise the control panel upward to release from screws securing top back edges and allow control panel to tip forward.
8. Remove infinite switch control knobs, infinite switches, indicator lights, rocker switches, and electronic control/clock (as necessary) and transfer the new control panel.
9. Reverse procedure to reinstall control panel.

Control Board Assembly

1. Remove control panel, see "Control Panel" procedure, steps 1 through 6.
2. Remove screws securing control board bracket to control panel.
3. Label and disconnect terminal plug from control board assembly.
4. Reverse procedure to reinstall control board assembly.

Infinite Switch

1. Remove control panel, see "Control Panel" procedure for removal.
2. Label and disconnect wire terminals from infinite switch.
3. Remove knob on infinite switch being replaced.
4. Remove screws in front securing infinite switch to control panel.
5. Reverse procedure to reinstall infinite switch.

Indicator Lights

1. Remove control panel, see "Control Panel" procedure for removal.
2. Label and disconnect wire terminals from indicator light.
3. Slide indicator light while holding the lens from the front to release from control panel.
4. Reverse procedure to reinstall indicator light.

Rocker Switch

1. Remove control panel, see "Control Panel" procedure for removal.
2. Label and disconnect wire terminals from rocker switch.
3. Squeeze tabs on rocker switch and push outward to release from control panel.
4. Reverse procedure to reinstall indicator light.

Oven Sensor

1. Disconnect power before servicing.
2. Open oven door and remove screws securing sensor to oven cavity.

NOTE: Gently pull wiring through cavity wall.

3. Disconnect oven sensor at the connector terminal and remove.
4. Reverse procedure to reinstall sensor.

NOTE: Verify connection is pushed through the insulation.

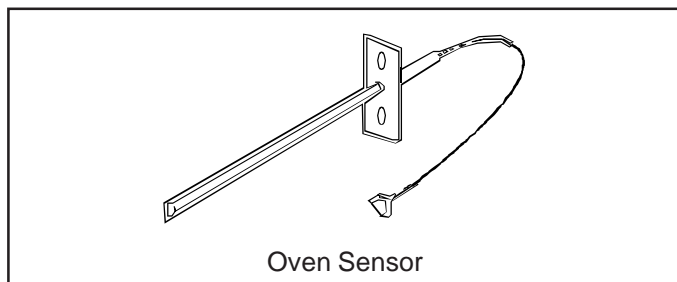

Oven Sensor

Bake Element

1. Turn power off.
2. Remove screws securing bake element to rear of oven wall.
3. Pull element forward to allow disconnection of terminals on each element leg.
4. Reverse procedure to reinstall bake element.

Disassembly Procedures



To avoid risk of electrical shock, personal injury or death; disconnect power to unit before servicing, unless testing requires power.

Broil Element

1. Turn power off.
2. Remove screws securing broil element to top and rear of oven cavity.
3. Pull broil element forward to allow disconnection of terminals on each element leg.
4. Reverse procedure to reinstall broil element.

Ribbon Elements

1. Remove maintop assembly, see "Maintop Assembly" procedure.
2. Remove screws securing element support bracket to maintop.
3. Label and disconnect wire terminals from element being replaced.
4. Release metal clips securing element to element support bracket.
5. Replace and reverse procedure to reinstall element.

Oven Door Removal



To avoid risk of personal injury or property damage, do not lift oven door by the handle.

1. Open oven door slightly and grasp door on both sides.
2. Lift up and off the hinge receivers.
3. Reverse procedure to reinstall oven door.

Oven Door Hinge Receiver

1. Turn off power to unit.
2. Remove oven door, see "Oven Door Removal" procedure.
3. Remove maintop assembly, see "Maintop Assembly" procedure.
4. Remove side panel, see "Side Panel Removal" procedures.
5. Remove storage drawer, see "Storage Drawer Removal" procedure.
6. Remove the top and bottom screws securing hinge receiver to the front frame.
7. Remove hinge receiver from oven chassis.
8. Reverse procedure to reinstall oven door hinge receiver.

Side Panel Removal

1. Turn power off.
2. Remove oven door, see "Oven Door Removal" procedure.
3. Remove maintop assembly, see "Maintop Assembly" procedure.

4. Remove screws securing lower rear galvanized cover from unit.
5. Remove screws securing top and back of side panel.
6. Pull rear of side panel away from range then slide side panel forward to release from side panel spacers.
7. Reverse procedure to reinstall side panel.

Backguard

NOTE: Requires removal of oven from installation position.

1. Remove maintop assembly, see "Maintop Assembly" procedure.
2. Remove screws securing upper back panel from unit.
3. Remove screws securing bottom outside edges of the backguard to unit chassis.
4. Reverse procedure to reinstall backguard.

Storage Drawer Removal

1. Pull drawer straight out to first stop. Lift the front and pull out to second stop.
2. Let front of door rest on floor. Place hands toward back of drawer and lift it out.

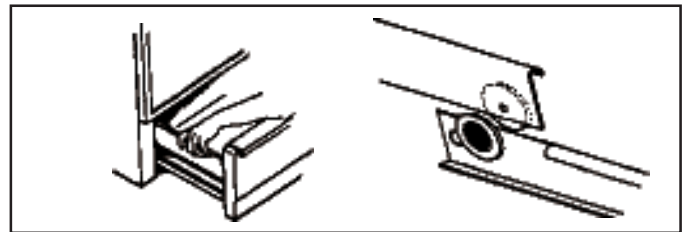

3. To replace:
 - a. Place the set of rollers on the drawer behind the set of rollers on the oven. (As shown above.)
 - b. Align the guides and push the drawer back into position.

Storage Drawer Track Removal

1. Remove the storage drawer by pulling it out to the fully open or stop position, lifting the drawer at the rear to disengage the drawer track rollers from the drawer runners, and sliding the drawer out of the range.
2. The tracks are mounted to a rear support and the frame of the range. Remove the two track mounting screws and remove the track. If the track support is being replaced, remove the mounting screw securing it to the side frame and remove the support.

Disassembly Procedures



To avoid risk of electrical shock, personal injury or death; disconnect power to unit before servicing, unless testing requires power.

Oven Light Assembly

Oven Light Bulb/Oven Light Socket

1. Remove power from unit (at the circuit breaker).
2. Open oven door and remove oven racks.
3. Hold lamp cover in place, and slide retaining wire off cover.

NOTE: Cover will fall if not held in place when removing retaining wire.

4. Unscrew lamp and remove.
5. Gently pry retaining clips inward towards center of socket.
6. Once retaining clips are released, gently pull socket into oven cavity.
7. Label and disconnect wire terminal connections and remove socket.
8. Reverse procedure to reassemble.

NOTE: Reposition fiberglass insulation around oven light socket to eliminate possibility of heat related problems.

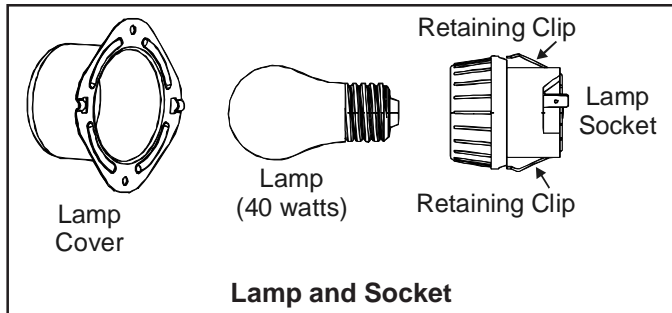

Door Disassembly

1. Remove oven door, see "Oven Door Removal" procedure.
2. Place door on a protected surface.
3. Remove screws securing door panel to door lining and remove door panel.
4. Remove screws securing outer door glass support to door baffle.
5. Remove outer door glass and place in a protected area.
6. Remove screws securing door baffle to door lining and remove door baffle.
7. Remove door insulation.
8. Remove inner door glass and place in a protected area.

NOTE: Proceed with the following steps for door handle removal.

9. Remove screws securing door handle to door panel and remove door handle.
10. Reverse procedures to reassemble.

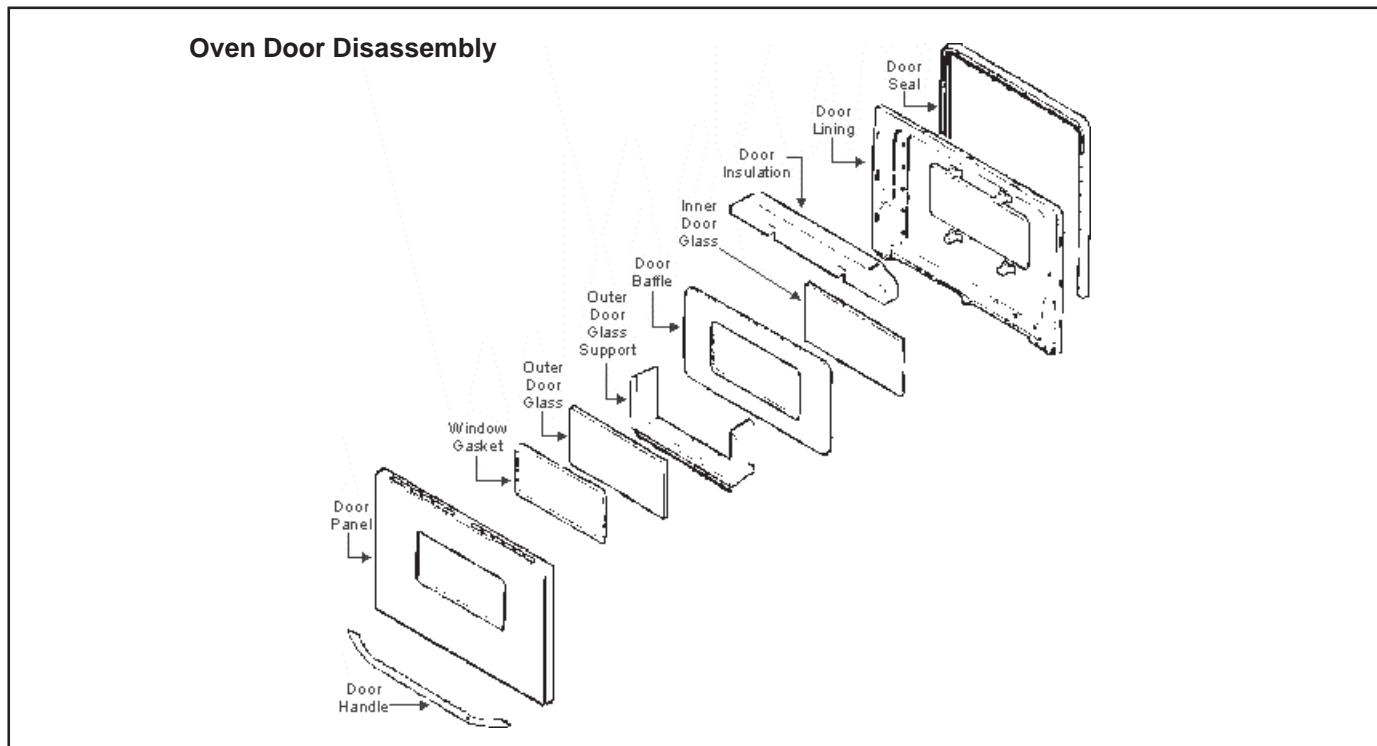

Appendix A

Installation Instructions

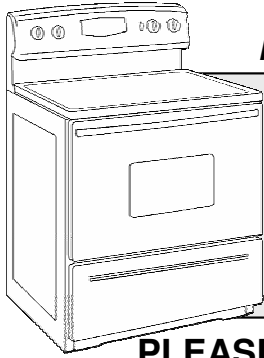

INSTALLER: LEAVE THESE INSTRUCTIONS WITH THE APPLIANCE

INSTALLATION MANUAL **Magic Chef Model CER3725AGW** **AC 400/230V 3 Phase 50 Hz Electric 30-inch Range**

PLEASE KEEP THIS MANUAL FOR FUTURE REFERENCE

THE MANUAL IS INTENDED TO ASSIST IN THE INITIAL INSTALLATION AND ADJUSTMENTS OF THE RANGE.

SPECIAL WARNING

Only qualified personnel should install or service this range.

Read "Safety Instructions" in the Use & Care book before using range.

Improper installation, adjustment, alteration, service, maintenance or use of range can result in serious injury or property damage.

CLEARANCE DIMENSIONS

For complete information in regard to installation of a freestanding range, see figures 1 and 2 on page 2. For **SAFETY CONSIDERATIONS** do not install a range in any combustible cabinetry which is not in accord with the installation clearances shown in figure 1.

MOBILE HOMES

The installation of the range in a mobile home must conform with the US Manufactured Home Construction and Safety Standard, Title 24 CFR, Part 3280 (formerly the Federal Standard for Mobile Home Construction and Safety, Title 24 HUD, Part 280). When that standard is not applicable, the range installation must meet the Standard for Manufactured Home Installations 1982 (Manufactured Home Sites, Communities and Set-Ups), ANSI A225. 1 - latest edition. The range installation must comply with local codes.

LOCATING THE RANGE

Place the range in a well lit area. Do not set the range over holes in the floor or other locations where it may be subject to strong drafts. Any opening in the wall behind the range and in the floor under the range should be sealed. Make sure the flow of cooling/ventilation air is not obstructed below the range.

CAUTION: This range has been designed in accordance with the requirements of various safety agencies and complies with the maximum allowable wood cabinet temperatures of 194°F. If this range is installed with cabinets that have a lower working temperature than 194°F, discoloration, delamination or melting may occur.

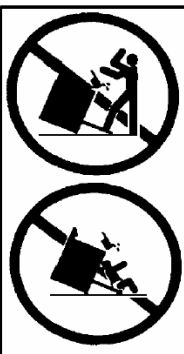

WARNING

- **ALL RANGES CAN TIP AND CAUSE INJURIES TO PERSONS.**
- **INSTALL ANTI-TIP DEVICES PACKED WITH RANGE.**
- **FOLLOW ALL INSTALLATION INSTRUCTIONS.**

Your range may not be equipped with some of the features referred to in this manual.

8101P726-60
(12-05-00)

Installation Instructions

INSTALLATION DRAWINGS

IMPORTANT
**PLEASE KEEP FOR THE USE OF THE
 LOCAL ELECTRICAL INSPECTOR.**

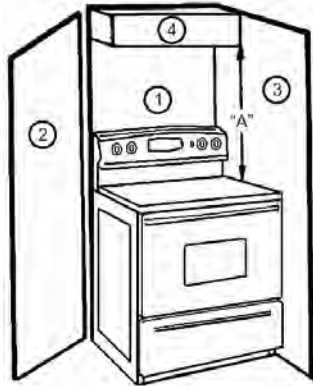

FIGURE 1

NOTE: Figure may not be representative of actual unit.

"A" = 30 inches (76.2 cm) minimum clearance between the top of the cooking surface and the bottom of an unprotected wood or metal cabinet, or "A" = 24 inches (61 cm) minimum when bottom of wood or metal cabinet is protected by not less than 1/4-inch (6.4 mm) thick flame-retardant millboard covered with not less than No. 28 MSG sheet steel, 0.015-inch (0.381 mm) thick stainless steel, 0.024-inch (0.610 mm) thick aluminum, or 0.020-inch (0.508 mm) thick copper.

To eliminate the risk of burns or fire by reaching over heated surface units, cabinet storage space located above the surface units should be avoided. If cabinet storage is to be provided, the risk can be reduced by installing a range hood that projects horizontally a minimum of 5 inches (13 cm) beyond the bottom of the cabinets.

FIGURE 1
 1, 2, 3 - COMBUSTIBLE BUILDING WALLS.
 4 - COMBUSTIBLE WALL CABINET.

A freestanding range may be installed adjacent to (0" from) combustible walls 1, 2 & 3.

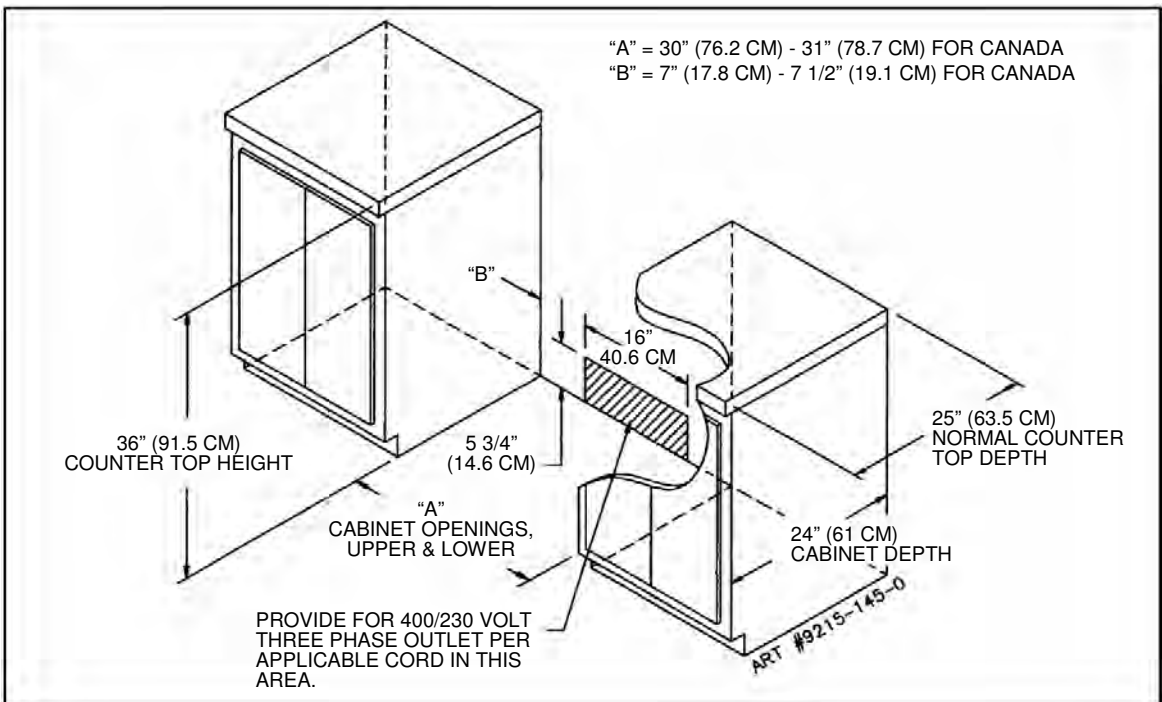

FIGURE 2

Installation Instructions

ANTI-TIP DEVICE INSTALLATION INSTRUCTIONS

WARNING: A risk of range tip over exists if the appliance is not installed in accordance with the installation instructions provided. The proper use of this device minimizes the risk of TIP-OVER. In using this device, the consumer must still observe the safety precautions as stated in the USE and CARE MANUAL and avoid using the oven door and/or lower drawer as a step stool. Installation instructions are provided for wood and cement in either floor or wall. Any other type of construction may require special installation techniques as deemed necessary to provide adequate fastening of the ANTI-TIP bracket to the floor or wall. The bracket may be installed to engage the left or the right rear leveling foot.

STEP 1 - Locating the Bracket (See Figure 3)

- A. Determine where either the right or left rear "EDGE" of the range will be located and mark the floor or wall.
- B. Place the BRACKET 15/16" (24 mm) from the marked "EDGE" toward center of opening and against the back wall as shown in figure 3, with orientation hole against wall.
- C. Use the bracket as a template and mark the required holes, as shown in figure 3 for the type of construction you will be using.
- D. Freestanding range may be secured to either floor or wall.

STEP 2 - Anti-Tip Bracket Installation

- A. Wood Construction:
 1. Floor: Locate the center of the two holes identified in figure 3 as "HOLES FOR FLOOR". Drill a 1/8" (3 mm) pilot hole in the center of each hole (a nail or awl may be used if a drill is not available). Secure the ANTI-TIP bracket to the floor with the two screws provided. Proceed to STEP 3.
 2. Wall: Locate the center of the two holes identified in figure 3 as "HOLES FOR WALL". Drill an angled

1/8" (3 mm) pilot hole in the center of each hole as shown in figure 4. (A nail or awl may be used if a drill is not available). Secure the ANTI-TIP bracket to the wall with the two screws provided as shown in figure 4. Proceed to STEP 3.

B. Cement or Concrete Construction:

Suitable screws for concrete construction can be obtained at a hardware store. Drill the required size hole for the screws obtained into the concrete at the center of the holes identified in figure 3 as "HOLES FOR FLOOR". Secure the ANTI-TIP bracket to the floor. Proceed to STEP 3.

STEP 3 - Range Installation

- A. A freestanding range may be installed by one person.
- B. Align the range to its designated location and slide it back into position. Note: A minimum clearance of 1/4" (6 mm) is required between the range and the leveling foot that will engage the ANTI-TIP bracket, see figure 4.

CAUTION: Damage to the range may occur if range is moved or lifted by grasping the maintop or backguard.

- C. All freestanding ranges with a glass top have a non-lift-up top. Coil tops are lift-up.
- D. For SAFETY CONSIDERATIONS as well as optimum performance, adjust the range so that it is level. This may be checked by placing a spirit level or a large pan of water on the cooktop or the oven rack. If an adjustment is required, pull the range forward, tip the range and rotate the leveling feet as required.
- E. To check the range for proper installation of the anti-tip bracket: Use a flashlight and look underneath the bottom of the range to see that one of the rear leveling feet is engaged in the bracket slot.
- F. Proceed with the remainder of the installation instructions provided with the range.

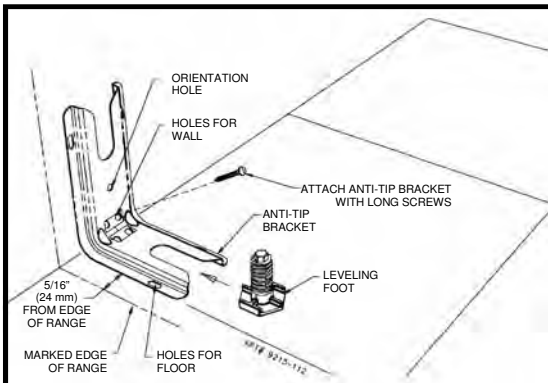

FIGURE 3

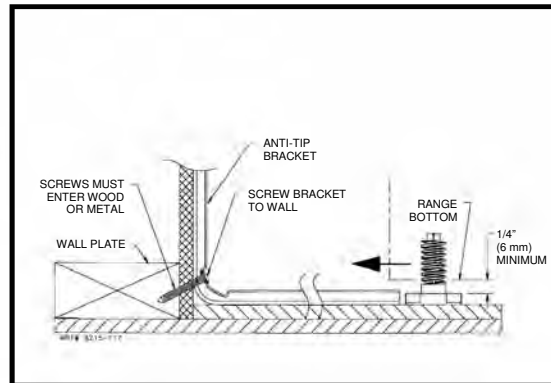

FIGURE 4

Installation Instructions

CONNECTING THE RANGE

ELECTRIC SUPPLY

The range must be installed in accordance with Local Codes or the US National Electric Code (NEC) ANSI/NFPA No. 70-latest edition. See the rating plate for the total connected KW rating.

OUTSIDE WIRING

Your local utility company will tell you whether the present electric service to your home is adequate. It may be necessary to increase the size of the wiring to the house and the service switch to take care of the electrical load demanded by the range. The kilowatt rating for the range is specified on the rating plate located on the front of the range.

HOUSE WIRING

Most local Building Regulations and Codes require that all electrical wiring be done by licensed electricians. All wiring should conform to Local Codes and National Electrical Codes. This range requires a five-wire, three-phase, 400 volt phase to phase, 230 volt phase to neutral, protective earth, 50 Hz AC circuit. Wiring codes require that a separate circuit be run from the main entrance panel to the range and that it be equipped with fuses and a separate disconnect switch which disconnects all phases, either in the main entrance panel or in a separate switch and a fuse box. In some communities, a solid or flexible continuous armored conduit must be used from the main entrance panel to the terminal box on the rear of the range. Others will permit the termination of the range circuit at a plug-in outlet placed at a convenient point near the back of the range. The range is then connected to this outlet

through an approved power cord fastened securely to the terminal block with a proper strain relief at the range and an approved plug at the opposite end.

RANGE CONNECTIONS

Some models of ranges are shipped direct from the factory with power cords attached. There are no range connections necessary on these models. Just plug the power cord into the range outlet. On models that are not provided with a power cord, connection to the power supply is necessary. REMEMBER - only an approved power cord that conforms to Local Codes and National Electrical Codes must be used.

USE COPPER OR ALUMINUM CONDUCTORS. The main terminal block is agency recognized for use with Copper or Aluminum conductors. Make connections as explained below and with reference to the illustration (see figure 6). After installation, insure tightness of all electrical connections and replace all covers.

NOTE: For cord replacement use **ONLY** an approved power cord that conforms to Local Codes and National Electrical Codes and that is rated at 380 to 415 volts and 16 amperes per phase that is marked for use with nominal 1 3/8" (34.93 mm) diameter connection opening, with closed loop terminals and marked for use with electric ranges.

TERMINAL BLOCK ACCESS: Remove the terminal block access cover from the range back (See figure 5). Remove the hex nut holder (See figure 6).

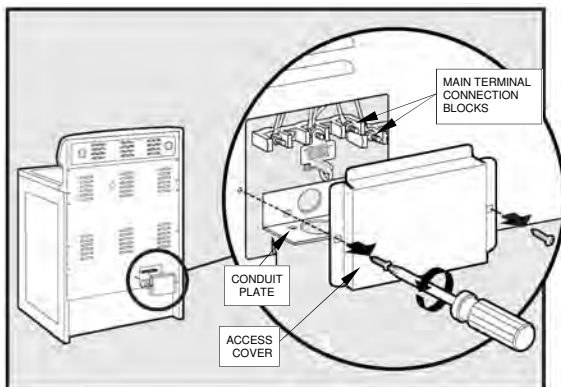

FIGURE 5

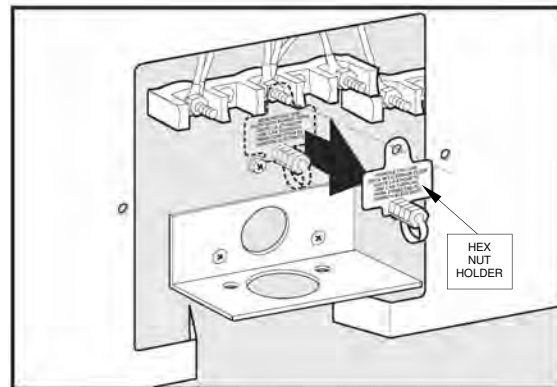

FIGURE 6

Installation Instructions

CONNECTING THE RANGE

CONTINUED:

CONDUIT PLATE: For use with a cord skip figures 7 and 8. For use with conduit, remove the screws and remove the plate (See figure 7). Position the plate for conduit and reattach (See figure 8).

FIVE WIRE SERVICE CORD OR CONDUIT INSTALLATION: Pull the service cord through (See figure 9). **The protective earth wire must connect to the protective earth screw** (See figure 10). Connect the remaining wires (See figure 11).

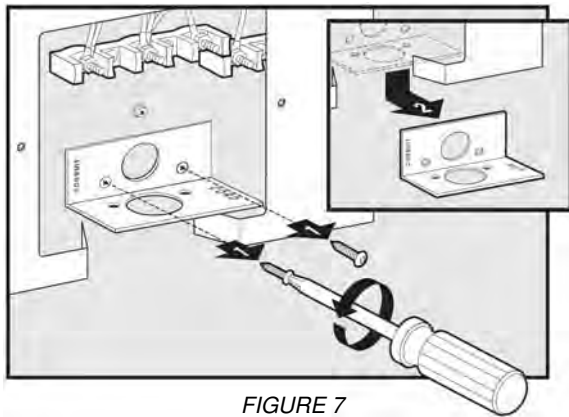

FIGURE 7

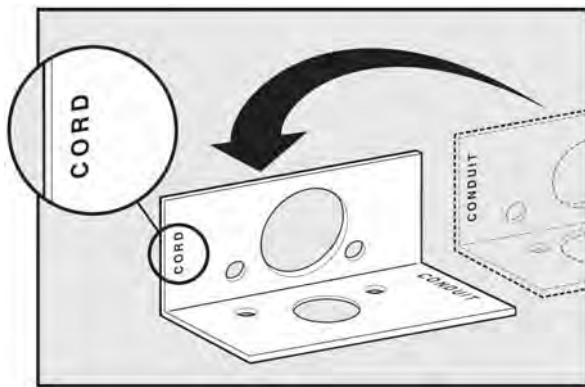

FIGURE 8

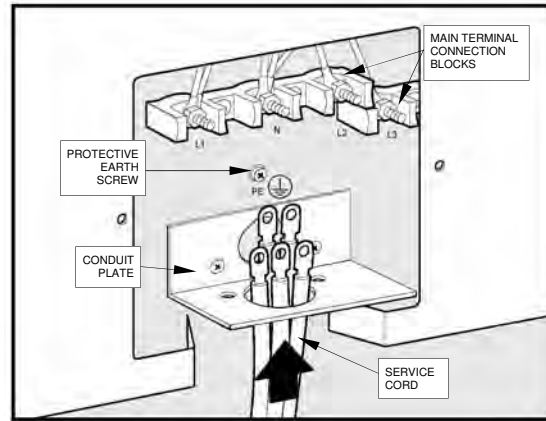

FIGURE 9

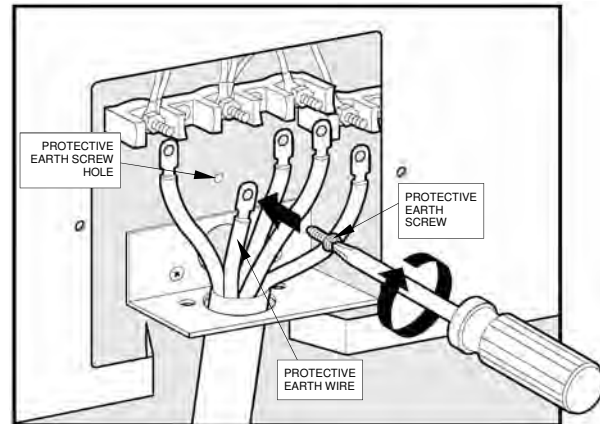

FIGURE 10

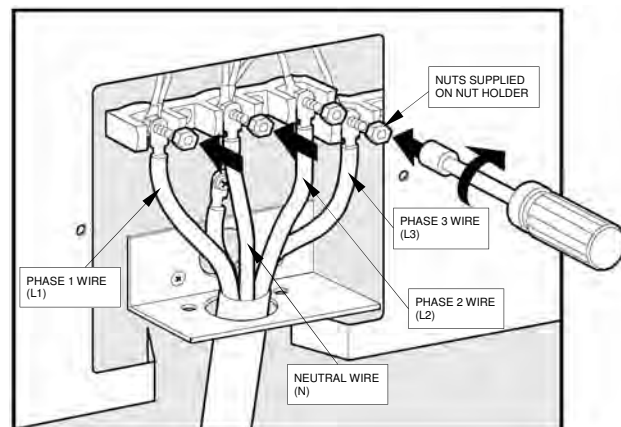

FIGURE 11

Installation Instructions

CONNECTING THE RANGE

CONTINUED:

BARE WIRE CONNECTION: For a bare wire connection, attach the lugs (See figure 12). Use the proper torque (See the Bare Wire Torque Chart). Pull the service cord through (See figure 13). **The earth wire must attach to the earth screw** (See figure 14). Connect the remaining wires (See figure 15).

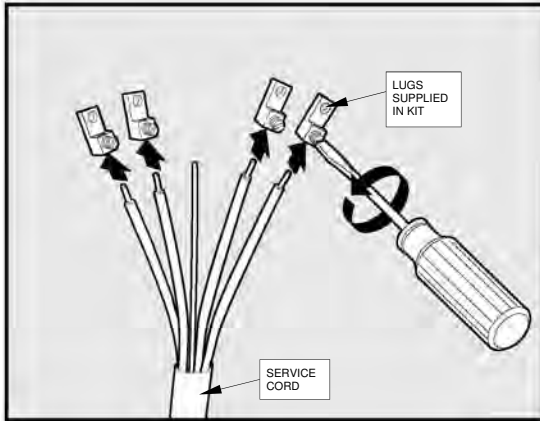

FIGURE 12

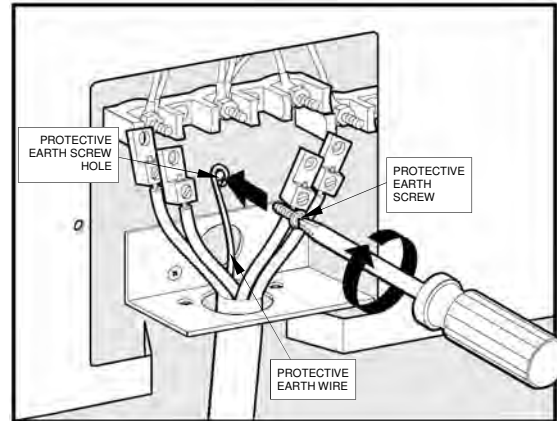

FIGURE 14

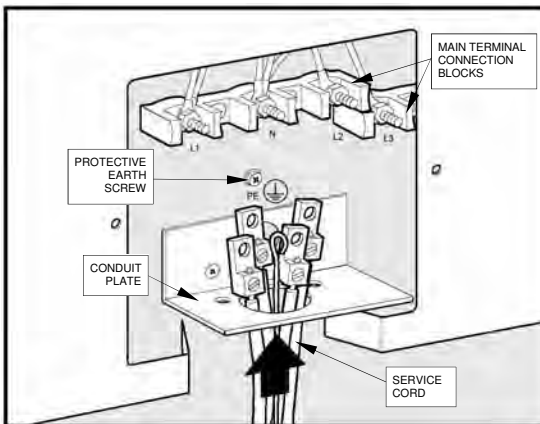

FIGURE 13

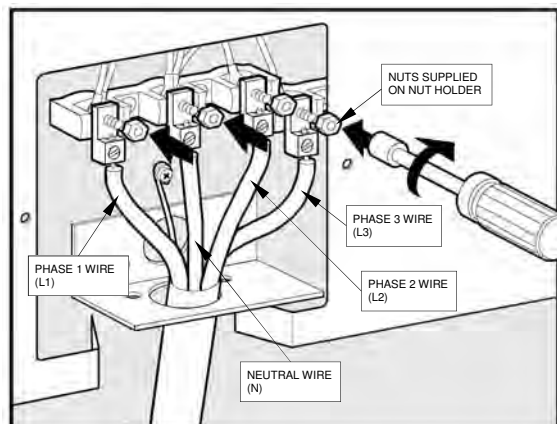

FIGURE 15

Bare Wire Torque Specifications	
Lug Attached to Terminal Block—20 inch-pounds	
American Wire Gage	Torque
10-14	20 inch-pounds
8	25 inch-pounds
4-6	35 inch-pounds

Installation Instructions

CONNECTING THE RANGE

CONTINUED:

STRAIN RELIEF INSTALLATION: Position the rear strain relief (See figure 16). Position the front strain relief (See figure 17). Insert and tighten the screws (See figure 18).

ACCESS COVER INSTALLATION: Replace the terminal block access cover (See figure 19).

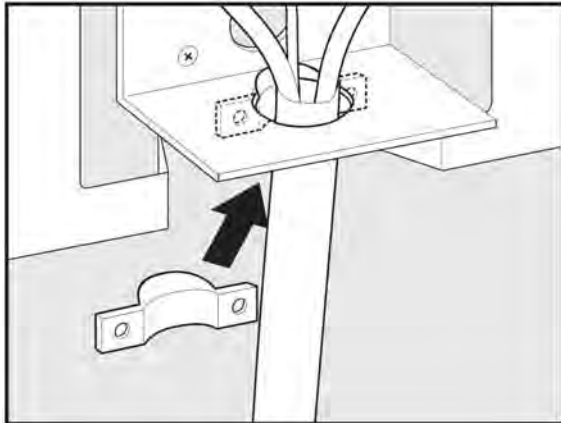

FIGURE 16

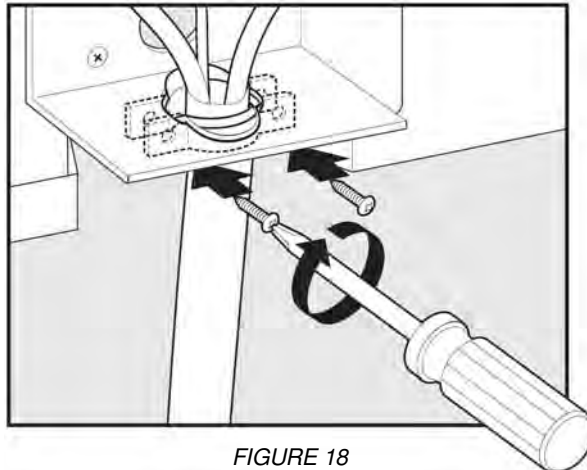

FIGURE 18

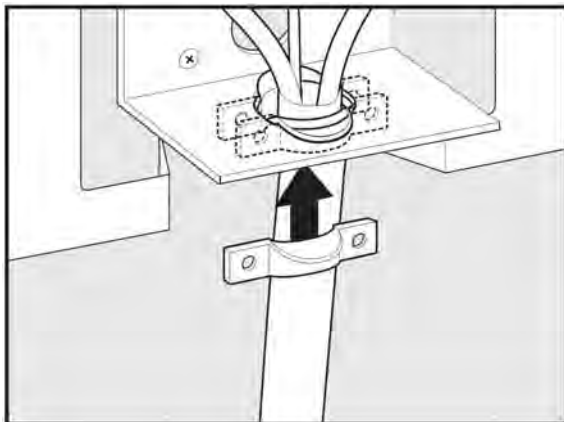

FIGURE 17

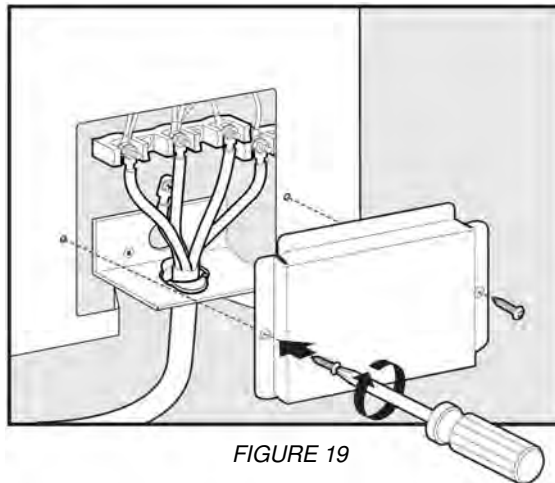

FIGURE 19

SERVICE- PARTS INFORMATION

When your range requires service or replacement parts, contact your dealer or authorized service agency. Please give the complete model and serial numbers of the range, which is located on the range model-number plate.

Appendix B

Use and Care Instructions



USER'S GUIDE

Electric Smoothtop Range

CER3725AGW

Use and Care Instructions

Automatic Shut-Off/ Sabbath Mode

The oven will automatically turn off after 12 hours if you accidentally leave it on. This safety feature can be turned off.

To cancel the 12-hour shut-off and run the oven continuously for 72 hours:

1. Set the oven to bake.
2. Press and hold the **CLOCK** pad for five seconds. 
 - SAb will be displayed and flash for five seconds.
 - SAb will then be displayed continuously until turned off or until the 72-hour time limit is reached.
 - BAKE will also be displayed if a bake cycle is in use while the oven is in Sabbath Mode.

All other functions EXCEPT BAKE (Timer, etc.) are locked out during the Sabbath Mode.

To cancel Bake when in Sabbath Mode:

Press **CANCEL**.

- BAKE will turn off in the display. 
- No beeps will sound.

To cancel the Sabbath Mode:

1. Press the **CLOCK** pad for five seconds. 
OR
2. After 72 hours, the Sabbath Mode will end.
 - SAb will flash for five seconds.
 - The time of day will return to the display.

Notes:



- Sabbath Mode can be turned on at any time with or without the oven on.
- Sabbath Mode cannot be turned on if the touchpads are locked out or when the door is locked.
- If the oven is baking when Sabbath Mode is set, "BAKE" will go out at the end of the baking cycle. There will be no audible beeps.
- When the Sabbath Mode is started, no preheat beep will sound.
- All prompts, messages and beeps are deactivated when Sabbath Mode is active.
- Pressing **CANCEL** will cancel a Bake cycle, however the control will stay in the Sabbath Mode.
- If power fails, the oven will power up in Sabbath Mode with 72 hours remaining and no cycle active.

Adjusting the Oven Temperature

Oven temperatures are carefully tested for accuracy at the factory. It is normal to notice some baking or browning differences between a new oven and an old one. As ranges get older, the oven temperature can shift.

You may adjust the oven temperature if you think the oven is not baking or browning correctly. To decide how much to change the temperature, set the temperature 25° higher or lower than your recipe recommends, then bake. The results of the "test" should give you an idea of how much to adjust the temperature.

To adjust the oven temperature:

1. Press **BAKE**. 
2. Enter 550° by pressing the ▲ pad.
3. Press and hold the **BAKE** pad for several seconds or until 0° appears in the display. 

If the oven temperature was previously adjusted, the change will be displayed. For example, if the oven temperature was reduced by 15° the display will show "-15°".

4. Press the ▲ or ▼ pad to adjust the temperature.
Each time a pad is pressed, the temperature changes by 5°. The oven temperature can be increased or decreased by 5° to 35°.
5. The time of day will automatically reappear in the display.

You do not need to readjust the oven temperature if there is a power failure or interruption. Broiling and cleaning temperatures cannot be adjusted.

Changing Temp °C/°F

1. The factory default setting for temperature is Celsius.
2. To change the setting, press and hold the **CANCEL** and **BAKE** pads at the same time for three seconds.
3. A single beep will sound and the current setting will be displayed (°F or °C). (If no change is made, the range will return to the existing setting after 30 seconds.)
4. To change the setting, press the ▲ or ▼ pad. Press again to return to existing setting. Wait five seconds and the setting will be complete.

Use and Care Instructions

Select	Avoid
Flat, smooth-bottom pans.	Pans with grooved or warped bottoms. Pans with uneven bottoms do not cook efficiently and sometimes may not boil liquid.
Heavy-gauge pans.	Very thin-gauge metal or glass pans.
Pans that are the same size as the element.	Pans smaller or larger than the element by 1 inch.
Secure handles.	Cookware with loose or broken handles. Heavy handles that tilt the pan.
Tight-fitting lids.	Loose-fitting lids.
Flat-bottom woks.	Woks with a ring-stand bottom.

Canning and Oversize Cookware

All canners and large pots must have flat bottoms and must be made from heavy-gauge materials. This is critical on smoothtop surfaces. The base **must not** be more than 1 inch larger than the element.

When canners and pots do not meet these standards, cooking times may be longer, and cooktops may be damaged.

Some canners are designed with smaller bases for use on smoothtop surfaces.

When canning, use the High heat setting only until the water comes to a boil or pressure is reached in the canner. Reduce to the lowest heat setting that maintains the boil or pressure. If the heat is not turned down, the cooktop may be damaged.

Oven Cooking

Manual Clean Oven Control



Important: The display will show 12:00 when the appliance is first connected to power or if power is interrupted. The Bake and Broil indicators light when function is pressed.

A	BAKE	Use for baking and roasting.
B	BROIL	Use for broiling and top browning.
C	TIMER	Sets timer.
D	CLOCK	Use to set time-of-day clock.
E	CANCEL	Cancels all operations except timer and clock.
F	▲ or ▼	Enters or changes time, oven temperature. Sets HI or LO broil.

Using the Touchpads

- Press the desired pad.
- Press the ▲ or ▼ pad to enter time or temperature.
- A beep will sound each time a function pad is pressed. There is no beep for the ▲ or ▼ pad.
- A double beep will sound if a programming error occurs.

Important: Four seconds after pressing the ▲ or ▼ pad, the time or temperature will automatically be entered. If more than 30 seconds elapse between touching a function pad and the ▲ or ▼ pad, the function will be canceled and the display will return to the previous display.

Setting the Clock

1. Press the **CLOCK** pad.
 - The clock time cannot be set if the control is programmed for a bake, broil or timing operation.
2. Set the correct time of day using the ▲ or ▼ pads. If the ▲ or ▼ pad is not pressed within 30 seconds, the program will cancel. Press the **CLOCK** pad and begin again.

Setting the Timer

The timer can be set from one minute (:01) up to 99 hours and 59 minutes (99:59). Time will be displayed in minutes and not in seconds. **THE TIMER DOES NOT CONTROL THE OVEN.**

1. Press the **TIMER** pad.
 - 0:00 will light and the colon (:) will flash in the display.
2. Press the ▲ or ▼ pad until the desired time is displayed.
 - The timer will begin as soon as the time is set.
 - The flashing colon indicates that a timing operation is in progress. (The colon will not flash if the time of day or oven temperature is displayed.)
 - Two short beeps signal the end of the operation. "0:00" will appear in the display.
 - If desired, press the **CLOCK** pad and the time of day will briefly reappear in the display during a timing operation.

Use and Care Instructions

- If desired, press the **BAKE** or **BROIL** pads and the current temperature setting will briefly reappear in the display during a timing operation.

To cancel the timer operation:

Press and hold the **TIMER** pad for several seconds.

Baking, Roasting and Broiling

Setting the Controls For Baking or Roasting:

1. Press **BAKE** pad.

- 000 will light and the Bake indicator light will flash in the display. 
- If you press the **BAKE** pad and do not set an oven temperature within 30 seconds, the program will automatically cancel and the time of day will reappear in the display.

2. Press the **▲** or **▼** pad until the desired oven temperature is displayed. 

- The oven temperature can be set from 170° to 550° F.
- 350° will appear in the display when either **▲** or **▼** pad is pressed once.
- Press and tap the **▲** or **▼** pad to change the oven temperature by 5° increments or press and hold the **▲** or **▼** pad to change the oven temperature by 10° increments.
- 100° or the actual oven temperature, whichever is higher, will appear in the display when the oven turns on.
- The temperature in the display will increase in 5° increments until preset temperature is reached. A single beep will sound when the oven is preheated.
- Allow 10 to 15 minutes for the oven to preheat.
- To recall preset temperature during preheat, press the **BAKE** pad. The temperature will be displayed for three seconds.

- To change oven temperature during cooking, press the **BAKE** pad, then press the **▲** or **▼** pad until the desired temperature is displayed.
 - To change oven temperature during preheat, press the **BAKE** pad *twice*, then press the **▲** or **▼** pad until the desired temperature is displayed.
3. Place food in the oven. Check food for doneness at the minimum cooking time.
 4. At the end of cooking, press the **CANCEL** pad to turn the oven off and remove the food from the oven. 
 - The oven features an automatic shut-off. If the oven is left on for 12 hours it will automatically turn off and 000 will appear in the display. Press the **CANCEL** pad and the time of day will reappear in the display.

Setting the Controls For Broiling:

For best results, use pan designed for broiling.

1. Place broiler pan on recommended rack position. (See chart below.)

2. Press the **BROIL** pad. 

- “SEt” will light and the Broil indicator light will flash in the display.

3. Press the **▲** pad to select **HI** (high) Broil or the **▼** pad to set **LO** (low) Broil. 

- Select HI Broil for normal broiling.
- Select LO Broil for low temperature broiling to avoid excessive browning of longer cooking foods like poultry.
- If you do not select HI or LO Broil within 30 seconds, the program will automatically cancel and the time of day will reappear in the display.

4. Preheat broil element for three minutes. Broil with the oven door open to the first stop position (about 4 inches).

5. After broiling, press **CANCEL** to turn the oven off and remove the broiler pan from the oven. The current time of day will reappear in the display. 

Broiling Chart

FOODS	RACK POSITION*	DONENESS	TOTAL COOK TIME
Beef			
Steak, 1" thick	4	Medium	15 - 18 minutes
	4	Well Done	19 - 23 minutes
Hamburgers, 3/4" thick	4	Well Done	15 - 18 minutes
Pork			
Bacon	4	Well Done	6 - 10 minutes
Chops, 1" thick	4	Well Done	22 - 26 minutes
Ham - precooked slice, 1/2" thick	4	Warm	8 - 12 minutes
Poultry			
Chicken Pieces	3 or 4	Well Done	LO Broil 28 - 38 minutes
Seafood			
Fish Steaks, buttered, 1" thick	4	Flaky	10 - 15 minutes
Fillet	4	Flaky	8 - 12 minutes

* The top rack position is #5.

Important: This chart is a suggested guide. The times may vary with the food being cooked.

Care and Cleaning Instructions

Care & Cleaning

Cleaning Procedures

CAUTION

- Be sure appliance is off and all parts are cool *before* handling or cleaning. This is to avoid damage and possible burns.
- To prevent staining or discoloration, clean appliance after each use.
- If a part is removed, be sure it is correctly replaced.

* Brand names are registered trademarks of the respective manufacturers.

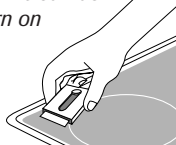
PART	PROCEDURE
Backguard and Cooktop – Porcelain Enamel	<p>Porcelain enamel is glass fused on metal and may crack or chip with misuse. It is acid-resistant, not acid-proof. All spillovers, especially acidic or sugary spillovers, should be wiped up immediately with a dry cloth.</p> <ul style="list-style-type: none"> • When cool, wash with soapy water, rinse and dry. • Never wipe off a warm or hot surface with a damp cloth. This may cause cracking or chipping. • Never use oven cleaners, abrasive or caustic cleaning agents on exterior finish of range.
Broiler Pan and Insert	<p>Never cover insert with aluminum foil as this prevents the fat from draining to the pan below.</p> <ul style="list-style-type: none"> • Place soapy cloth over insert and pan; let soak to loosen soil. • Wash in warm, soapy water. Use scouring pad to remove stubborn soil. • Broiler pan and insert can be cleaned in dishwasher.
Clock and Control Pad Area	<ul style="list-style-type: none"> • Wipe with a damp cloth and dry. Do not use abrasive cleaning agents as they may scratch the finish. • Glass cleaners may be used if sprayed on a cloth first. DO NOT spray directly on control pad and display area.
Control Knobs	<ul style="list-style-type: none"> • Remove knobs in the OFF position by pulling forward. • Wash, rinse and dry. Do not use abrasive cleaning agents as they may scratch the finish. • Turn on each element to be sure the knobs have been correctly replaced.
Cooktop – Glass-Ceramic	<p>Never use oven cleaners, chlorine bleach, ammonia or glass cleaners with ammonia. Important: Call an authorized servicer if the glass-ceramic top should crack, break or if metal or aluminum foil should melt on the cooktop.</p> <ul style="list-style-type: none"> • Allow the cooktop to cool <i>before</i> cleaning. • General --Clean cooktop after each use, or when needed, with a damp paper towel and Cooktop Cleaning Creme* (Part No. 20000001)**. Then, buff with a clean, dry cloth. <p>Important: Permanent stains will develop if soil is allowed to cook on by repeatedly using the cooktop when soiled.</p> <ul style="list-style-type: none"> • Heavy Soils or Metal Marks -- Dampen a “scratchless” or “never scratch” scrubber sponge. Apply Cooktop Cleaning Creme* (Part No. 20000001)** and scrub to remove as much soil as possible. Apply a thin layer of the creme over the soil, cover with a damp paper towel and let stand 30 to 45 minutes (2-3 hours for very heavy soil). Keep moist by covering the paper towel with plastic wrap. Scrub again, then buff with a clean, dry cloth. <p>Important: Only use a CLEAN, DAMP “scratchless” pad that is safe for non-stick cookware. The pattern and glass will be damaged if the pad is not damp, if the pad is soiled, or if another type of pad is used.</p> <ul style="list-style-type: none"> • Burned-on or Crusty Soils -- Scrub with a “scratchless” or “never scratch” scouring pad and Cooktop Cleaning Creme*. <p>Important: Hold a razor blade scraper at 30° angle and scrape any remaining soil. Then clean as described above. Do not use the razor blade for daily cleaning as it may wear the pattern on the glass.</p> <ul style="list-style-type: none"> • Melted Sugar or Plastic -- Immediately turn element to Low and scrape sugar or plastic from hot surface to a cool area. Then turn element OFF and allow to cool. Clean residue with razor blade scraper and Cooktop Cleaning Creme*. 

Cont.

Care and Cleaning Instructions

PART	PROCEDURE
Oven Window - Glass	<ul style="list-style-type: none"> • Avoid using excessive amounts of water which may seep under or behind glass causing staining. • Wash with soap and water. Rinse with clear water and dry. Glass cleaner can be used if sprayed on a cloth first. • Do not use abrasive materials such as scouring pads, steel wool or powdered cleaners as they will scratch glass.
Oven Interior - Manual Clean	<ul style="list-style-type: none"> • Clean frequently using mild abrasive cleaners and a plastic pad. • Do not use metallic scouring pads because they will scratch the surface. • When using commercial oven cleaners follow the manufacturer's instructions. • Wipe up acidic spills (tomato or milk based foods) as soon as possible with soap and water. If the spill is not wiped up, it may discolor the porcelain. <p>To make cleaning easier, remove the oven door, if desired. (See <i>Maintenance</i> section on page 6.)</p>
Oven Door, Storage Drawer, Door Handle, Side Panels - Painted Enamel	<ul style="list-style-type: none"> • When cool, wash with warm, soapy water, rinse and dry. Never wipe a warm or hot surface with a damp cloth as this may damage the surface and may cause a steam burn. • For stubborn soil, use mildly abrasive cleaning agents such as baking soda paste or Bon Ami.* Do not use abrasive, caustic or harsh cleaning agents such as steel wool pads or oven cleaners. These products will scratch or permanently damage the surface. <p>Important: Use a dry towel or cloth to wipe up spills, especially acidic or sugary spills. Surface may discolor or dull if soil is not immediately removed. This is especially important for white surfaces.</p>
Oven Racks	<ul style="list-style-type: none"> • Clean with soapy water. • Remove stubborn soil with cleansing powder or soap-filled scouring pad. Rinse and dry.

* Brand names for cleaning products are registered trademarks of the respective manufacturers.