

Service

This manual is to be used by qualified appliance technicians only. Maytag does not assume any responsibility for property damage or personal injury for improper service procedures done by an unqualified person.

27" Front Load Washer

This Base Manual covers general information.

Refer to individual Technical Sheet for information on specific models.

This manual includes, but is not limited to the following:

MAH6700AW*

Important Information

Important Notices for Servicers and Consumers

Maytag will not be responsible for personal injury or property damage from improper service procedures. Pride and workmanship go into every product to provide our customers with quality products. It is possible, however, that during its lifetime a product may require service. Products should be serviced only by a qualified service technician who is familiar with the safety procedures required in the repair and who is equipped with the proper tools, parts, testing instruments and the appropriate service information. **IT IS THE TECHNICIANS RESPONSIBILITY TO REVIEW ALL APPROPRIATE SERVICE INFORMATION BEFORE BEGINNING REPAIRS.**



WARNING

To avoid risk of severe personal injury or death, disconnect power before working/servicing on appliance to avoid electrical shock.

To locate an authorized servicer, please consult your telephone book or the dealer from whom you purchased this product. For further assistance, please contact:

Customer Service Support Center

Customer Assistance Information Resource (CAIR) Center

CAIR Center 1-800-688-9900

CAIR Center in Canada 1-800-688-2002

Brand

Web Site

Telephone Number

Maytag WWW.MAYTAG.COM 1-800-688-9900

Recognize Safety Symbols, Words, and Labels



DANGER

DANGER—Immediate hazards which **WILL** result in severe personal injury or death.



WARNING

WARNING—Hazards or unsafe practices which **COULD** result in severe personal injury or death.



CAUTION

CAUTION—Hazards or unsafe practices which **COULD** result in minor personal injury, product or property damage.

Table of Contents

Important Information	2
Important Safety Information	4
General Information	
Model Identification	8
Serial Label Location	8
Model Nomenclature	9
Troubleshooting Procedures	
Will Not Start	10
Leaking	10
No Tumble	10
Will Not Spin	10
No Water Fill	10
Tub Full of Suds	11
Wet Clothes	11
Will Not Lock	11
Will Not Unlock	11
Will Not Drain	11
Wrong Water Temperature	11
Vibration / Walking / Noise	12
Leaving Marks on Floor	12
Rubber Feet	12
Additive Cups Full of Water	12
Buttons Do Not Respond	12
Consumer Information Codes	12
Service Mode	13
Quick Spin Test	14
Hold Quick Spin Step	14
Fast Time Down Test	14
Quick Service Cycle	14
LED/Switch Test	14
Board Input Test	15
Board Output Test.....	15
Display Diagnostic Codes	17
Diagnostic Codes	17
Component Testing Information	19
Disassembly Procedures	
Top Cover Removal	24
Water Level Sensor Removal	24
MEMS Sensor Removal	25
Reactor Removal	25
EMI Filter	25
Water Valve Removal	26
Dispenser Removal	26
Console Removal	27
Door Removal	27
Front Panel Removal	29
Boot Removal	30
Motor Removal	31
Drain Pump Removal	33
Outer Tub/Spinner Removal	34
Appendix A	
Installation Instructions	A-2
Stacking Instructions	A-10
Appendix B	
Use And Care	B-2

Important Safety Information



WARNING

To reduce the risk of fire, electric shock, serious injury or death to persons when using your washer, follow these basic precautions:

- Read all instructions before using the washer.
- Refer to the Grounding Instructions in the Installation Manual for the proper grounding of the washer.
- Do not wash articles that have been previously cleaned in, washed in, soaked in, or spotted with gasoline, dry-cleaning solvents, or other flammable or explosive substances as they give off vapors that could ignite or explode.
- Do not add gasoline, dry-cleaning solvents, or other flammable or explosive substances to the wash water. These substances give off vapors that could ignite or explode.
- Under certain conditions, hydrogen gas may be produced in a hot water system that has not been used for two weeks or more. Hydrogen gas is explosive. If the hot water system has not been used for such a period, before using a washing machine or combination washer-dryer, turn on all hot water faucets and let the water flow from each for several minutes. This will release any accumulated hydrogen gas. The gas is flammable, do not smoke or use an open flame during this time.
- Do not allow children to play on or in the washer. Close supervision of children is necessary when the washer is used near children. This is a safety rule for all appliances.
- Before the washer is removed from service or discarded, remove the lid to the washing compartment.
- Do not reach into the washer if the wash tub is moving.
- Do not install or store the washer where it will be exposed to water and/or weather.
- Do not tamper with the controls.
- Do not repair or replace any part of the washer, or attempt any servicing unless specifically recommended in the User-Maintenance instructions or in published user-repair instructions that you understand and have the skills to carry out.
- To reduce the risk of an electric shock or fire, do not use an extension cord or an adapter to connect the washer to the electrical power source.
- Use your washer only for its intended purpose, washing clothes.
- Always disconnect the washer from electrical supply before attempting any service. Disconnect the power cord by grasping the plug, not the cord.
- Install the washer according to the Installation Instructions. All connections for water, drain, electrical power and grounding must comply with local codes and be made by licensed personnel

when required. Do not do it yourself unless you know how!

- To reduce the risk of fire, clothes which have traces of any flammable substances such as vegetable oil, cooking oil, machine oil, flammable chemicals, thinner, etc. or anything containing wax or chemicals such as in mops and cleaning cloths, must not be put into the washer. These flammable substances may cause the fabric to catch on fire by itself.
- Do not use fabric softeners or products to eliminate static unless recommended by the manufacturer of the fabric softener or product.
- Keep your washer in good condition. Bumping or dropping the washer can damage safety features. If this occurs, have your washer checked by a qualified service person.
- Replace worn power cords and/or loose plugs.
- Be sure water connections have a shut-off valve and that fill hose connections are tight. Close the shut-off valves at the end of each wash day.
- Loading lid must be closed any time the washer is in operational fill, tumble, or spin. Do not attempt to bypass the loading lid switch by permitting the washer to operate with the loading lid open.
- Always read and follow manufacturer's instructions on packages of laundry and cleaning aids. Heed all warnings or precautions. To reduce the risk of poisoning or chemical burns, keep them out of the reach of children at all times (preferably in a locked cabinet).
- Always follow the fabric care instructions supplied by the garment manufacturer.
- Never operate the washer with any guards and/or panels removed.
- Do not operate the washer with missing or broken parts.
- Do not bypass any safety devices.
- Failure to install, maintain, and/or operate this washer according to the manufacturer's instructions may result in conditions which can produce bodily injury and/or property damage.

NOTE: The Warnings and Important Safety Instructions appearing in this manual are not meant to cover all possible conditions and situations that may occur. Common sense, caution and care must be exercised when installing, maintaining, or operating the washer.

Always contact your dealer, distributor, service agent or the manufacturer about any problems or conditions you do not understand.

Important Safety Information

WARNING

To avoid personal injury or death from improper servicing, make sure you read and understand the descriptions and meaning of various safety symbols, words and labels used in this manual, before attempting any procedures described in the manual. Failure to understand and comply with safety information may result in severe personal injury or death.

General Information

This Service Manual describes the operation, disassembly, troubleshooting, and repair of the Compact washer. It is intended for use by authorized technicians who troubleshoot and repair these units.

NOTE: It is assumed that users of this manual are familiar with the use of tools and equipment used to troubleshoot and repair electrical and mechanical systems; and understand the terminology used to describe and discuss them.

Related Publications

This is a base service manual, covering a range of similar models. It is intended to be used in conjunction with the Parts Manual and Technical Sheet covering the specific model being serviced.

Electrical Service Information

Proper Grounding and Polarization of 120 Volts Wall Outlets

For the safety of our customers and the Service Technician ALL appliances have a three-prong power cord and **MUST** be connected to a properly polarized AND grounded wall outlet.

This information was written for those who do not understand grounding and polarization of a wall outlet. A 120 volt wall outlet must always be wired as shown below.

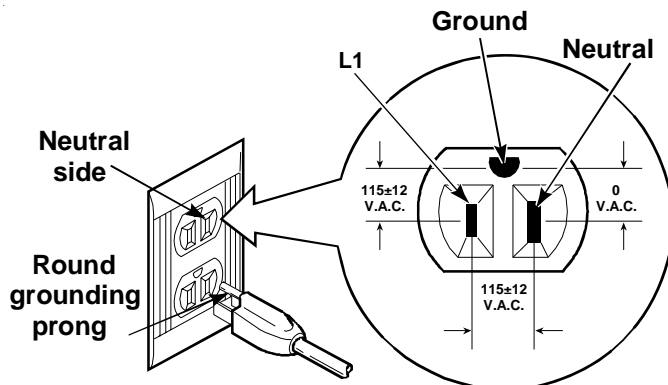

About Ground Wires

In the event of an electrical short circuit, a ground wire reduces the risk of electric shock by providing an escape wire for the electric current.

Standard accepted color coding for ground wires is **green** or **green with a yellow stripe**.

Grounding wires and wires colored like grounding wires are **NOT** to be used as current carrying conductors.

WARNING

To reduce the risk of fire, electric shock, serious injury or death, all wiring and grounding must conform with the latest edition of the National Electric Code, ANSI/NFPA 70, or the Canadian Electrical Code, CSA C22.1, and such local regulations as might apply. It is the customer's responsibility to have the wiring and fuses checked by a qualified electrician to make sure your home has adequate electrical power to operate the washer.

WARNING

To avoid risk of personal injury or death due to electrical shock:

- **Observe all local codes and ordinances.**
- Disconnect electrical power to unit before servicing.
- Ground appliance properly.
- Check with a qualified electrician if you are not sure this appliance is properly grounded.
- **DO NOT** ground to gas line.
- **DO NOT** ground to cold water pipe if pipe is interrupted by plastic, nonmetallic gaskets, or other insulating (nonconducting) materials.
- **DO NOT** modify plug on power cord. If plug does not fit electrical outlet, have proper outlet installed by qualified electrician.
- **DO NOT** have a fuse in the neutral or ground circuit. A fuse in the neutral or ground circuit could result in an electrical shock.
- **DO NOT** use an extension cord with this appliance.
- **DO NOT** use an adapter plug with this appliance.
- **DO NOT** pinch power cord.

Important Safety Information

Explanation

Polarization—This means that the larger slot must be neutral and the small slot must be at line voltage.

Mispolarized—The outlet is incorrectly wired so that the larger slot is at line voltage and the smaller slot is neutral.

Grounded—This means the round hole connection is connected to earth ground through a connection to the main power panel.

Ungrounded—The round hole connection is not complete to earth ground and/or the main power panel.

Grounding Instructions

WARNING

- To avoid the risk of electrical shock or death, do not alter the plug.
- Do not remove grounding prong when installing grounded appliance in a home that does not have three wire grounding receptacle. Under no condition is grounding prong to be cut off or removed. It is the personal responsibility of the consumer to contact a qualified electrician and have properly grounded three prong wall receptacle installed in accordance with appropriate electrical codes.
- To avoid the risk of electrical shock or death, this equipment must be grounded.

This equipment **MUST** be grounded. In the event of an electrical short circuit, grounding reduces the risk of electric shock by providing an escape wire for the electric current. This unit is equipped with a cord having a grounding wire with a grounding plug. The plug must be plugged into an outlet that is properly installed and grounded.

Consult a qualified electrician or technician if grounding instructions are not completely understood, or if doubt exists as to whether the equipment is properly grounded. Do not use an extension cord. If the product power cord is too short, have a qualified electrician install a three-slot receptacle. This unit should be plugged into a separate 60 hertz circuit with the electrical rating as shown in the appropriate drawing. Models operate with a supply voltage of 120 Volts.

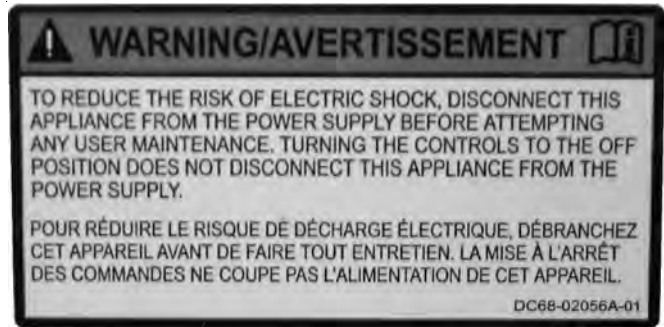

Important Safety Information



⚠ CAUTION/ATTENTION 

- KEEP CLEAR ROTATING BELTS AND PULLEYS
- RESTEZ ÉLOIGNÉ DES COURROIES ET DES POULIES EN ROTATION

DC06-02004A-01



⚠ WARNING/AVERTISSEMENT

• THIS CONTROL BOARD IS INTENTIONALLY NOT GROUNDED AND MAY PRESENT A RISK OF ELECTRIC SHOCK ONLY DURING SERVICING. SERVICE PERSONNEL — DO NOT CONTACT THIS PART WHILE APPLIANCE IS ENERGIZED.

DRAIN HOSE INSTALLATION / INSTALLATION DU TUYAU D'ÉVACUATION : MAYTAG

▶ If the standpipe is less than 36" high, the drain hose must be routed through clip on the cabinet back to raise hose to proper height.

▶ Si la hauteur de la conduite verticale est inférieure à 36 po, il faut passer le tuyau d'évacuation dans l'attache à l'arrière de l'appareil.



CLIP / ATTACHE

▶ If an airtight connection between the drain hose and standpipe is demanded, an anti-siphon valve is needed.

▶ Si une connexion étanche est exigée entre le tuyau d'évacuation et la conduite verticale, il est alors nécessaire d'installer une soupape anti-siphonnement.

WARNING

ELECTRICAL GROUNDING INSTRUCTIONS

THIS APPLIANCE IS EQUIPPED WITH A THREE-PRONG (GROUNDING) PLUG FOR YOUR PROTECTION AGAINST SHOCK HAZARD AND SHOULD BE PLUGGED DIRECTLY INTO A PROPERLY GROUNDED THREE-PRONG RECEPTACLE. DO NOT CUT OR REMOVE THE GROUNDING PRONG FROM THIS PLUG.

DC06-02004A-01



⚠ WARNING

⚠ NEVER reach into the washer until the tub has completely stopped spinning.

⚠ NEVER wash articles containing flammable fumes or materials like petroleum and cleaning products, cooking oils etc.

⚠ NEVER allow children to operate or play in, with or around the washer

General Information

Model Identification

Complete registration card and promptly return. If registration card is missing:

- For Maytag product call 1-800-688-9900 or visit the Web Site at www.maytag.com
- For product in Canada call 1-866-688-2002 or visit the Web Site at www.maytag.com

When contacting Maytag service, provide product information located on rating plate. Record the following:

Model Number: _____
Manufacturing Number: _____
Serial or S/N Number: _____
Date of purchase: _____
Dealer's name and address: _____



Serial Label is located on the back of the unit and the front behind the door.



Service

Keep a copy of sales receipt for future reference or in case warranty service is required. To locate an authorized technician:

- For Maytag call 1-800-462-9824 or visit the Web Site at www.maytag.com.
- For product in Canada call 1-866-688-2002 or visit the Web Site at www.maytag.com.

Warranty service must be performed by an authorized technician. We also recommend contacting an authorized technician, if service is required after warranty expires.

Parts and Accessories

To order parts and accessories for your product:

- For Maytag product call 1-800-462-9824 or visit the Web Site at www.maytag.com.
- For product in Canada call 1-866-688-2002 or visit the Web Site at www.maytag.com.

Extended Service Plan

We offer long-term service protection for this new appliance.

- Asure™ Extended Service Plan is specially designed to supplement Amana's strong warranty. This plan covers parts, labor, and travel charges. Call 1-866-232-6244 for information.
- Dependability PlusSM Extended Service Plan is specially designed to supplement Maytag's and Jenn-Air's strong warranty. This plan covers parts, labor, and travel charges. Call 1-800-925-2020 for information.



General Information

Washer Nomenclature

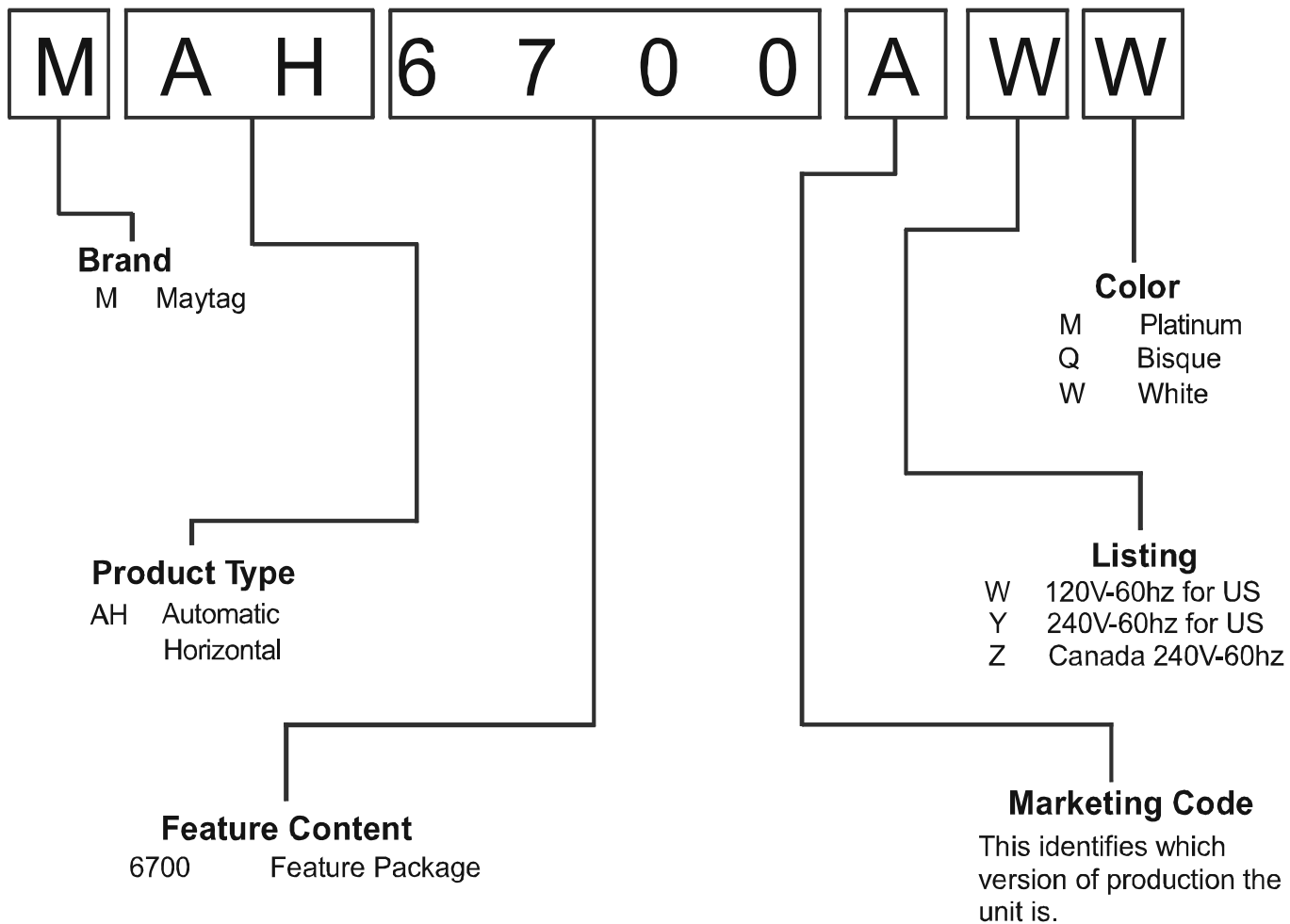

Trouble Shooting and Diagnostic Guide is located behind the unit taped to the back.



Troubleshooting Procedures



WARNING

To avoid risk of electrical shock, personal injury or death, disconnect power to unit before servicing, unless testing requires power.

Place washer into **Service Mode** and check for diagnostic codes. See **Technical Data Sheet** taped to rear panel.

Will Not Start

- Plug cord into live electrical outlet. Check for proper voltage.
- Check fuse or reset circuit breaker.
- Push any key to turn 'ON' the clothes washer and press the **Rotary Cycle Selector** knob to start the clothes washer.
- Close door and push the **Rotary Cycle Selector** knob to start the clothes washer.
- Check to see if the clothes washer is in a pause, soak or suds period in the cycle. Wait briefly and it may start. If washer is in suds period, "Su" and "dS" will display alternately, instead of the time remaining.
- Check for restricted drain system. If there is an electrical problem in the drain system, "nd" error will occur after 15 minutes.
- Check water supply.
- Check the line screen and water valve screen.
- Check for loose connections at machine control board terminal connections CN5 and CN6 (See "Component Testing Information").
- Replace machine control board.

Leaking

- Make sure inlet hose connections are not leaking. Check for rubber gasket damage due to over-tightening.
- Check standpipe for leak. Wrap a dry rag around the standpipe opening. If rag becomes wet, leak is fault of home plumbing. Be sure the standpipe is capable of accepting the incoming flow of water from the clothes washer.
- Make sure end of drain hose is correctly inserted and secured to drain standpipe.
- Check internal hose connections (fill, drain systems, dispenser hoses & clamps).
- Check rubber boot. Remove, reposition and reinstall, if necessary.
- Check for possible kinked dispenser to outer tub hose. Hot water pressurization may force door open.

No Tumble

- Start normal cycle with an empty machine and allow a fill to check tumble.
- See **Board Output Test**, or **Quick Spin Test** (Before test, make sure that the tumbler is empty.)
- Check for loose connections at machine control board, pressure switch, motor, tach harness and motor control.

- Check motor windings resistance (See "Component Testing Information").
At CN9, pins 1 & 3 = 3.0 ohms.
Pins 1 & 2 = 3.0 ohms.
Pins 2 & 3 = 3.0 ohms.
- Check belt.
- Faulty main control board.
- Faulty motor.

Will Not Spin

- Check to make sure the door is fully closed.
- Check for water left inside the clothes washer. If present, see **Will Not Drain**.
- See **Board Output Test** or **Quick Spin Test**. (Before test, make sure that the tumbler is empty.) If it doesn't tumble after the test above, check unbalanced load scenario, machine control board, and motor.
- Check for loose connections at pressure switch, motor, tach harness, motor control and machine control board terminal connections CN8, CN9, CN3 (See "Component Testing Information").
- Check motor windings resistance (See "Component Testing Information").
At CN9, pins 1 & 3 = 3.0 ohms.
Pins 1 & 2 = 3.0 ohms.
Pins 2 & 3 = 3.0 ohms.
- Check belt.

No Water Fill

- Test water fill. See **Board Output Test**.
- Check to make sure water supply is turned on fully.
- Check electrical circuit and connections at the water valve, and pressure switch.
- Check for kinks in inlet hoses.
- Check for clogged inlet screens.
- Visually check hot, cold, and bleach separately for fill.
- Check for low water pressure. May be dependent on pressure entering home. Variations may occur due to usage in the home at the time machine is used.
- Check for frozen pipes and hoses.
- Check resistance of water valve coils (See "Component Testing Information"). Check pin #1 of CN7 with pin #1,2 or 4 of CN10. Normal is 1.18K ohms.
- Check for loose connections at the pressure switch or on the machine control board at CN3. (See "Component Testing Information").

Troubleshooting Procedures



WARNING

To avoid risk of electrical shock, personal injury or death, disconnect power to unit before servicing, unless testing requires power.

Tub Full of Suds

- Check for restricted drain system. See **Will Not Drain** and **Will Not Spin**.
- Check for loose wire connections at control board and pump.
- Check to see if belt is off motor and pulley.
- Use high efficiency or low sudsing detergent specially formulated for front load washers.
- Reduce detergent amount for that specific load size and soil level. Towel loads have a minimal amount of soil present and typically create more suds.
- Use drain pump and cold water to empty tub. See **Board Output Test**.
- Run the clothes washer through another complete cycle using the coldest water, tablespoon of salt and no detergent.

Wet Clothes

- Very small clothes loads can cause unbalanced loads. Add additional towels.
- Excessive suds may have been present, due to not using high efficiency detergent. Reduce amount of detergent usage.
- See **Will Not Spin**.
- “Drain Only” or “Low” **Spin Speed** was selected.

Will Not Lock

- Door not all the way closed or not properly aligned. Possible laundry load is too large to close door.
- Place washer into **Service Mode** and check for diagnostic codes 4, 18 & 22. See **Service Mode**.
- Check door lock system. See **Board Output Test**. Check the output voltage of door lock coil. If normal, change door lock switch. If not normal, change main control board. (See “Component Testing Information”).
- Check electrical connections at door lock switch assembly and machine control board (CN10), (See “Component Testing Information”).

Will Not Unlock

- Push door closed to make sure nothing from inside is pressing against it, which may keep it from unlocking.
- Door locked from water level too high. Opening door will result in water draining from door opening.
- Check for water remaining in the drum. If water is present inside drum, see **Will Not Drain**.
- Check if temperature inside the drum is higher than 50°C/122°F. If there is no problem with

temperature, check wiring of machine control board and door lock switch.

- Drain manually by removing drain hose clamp.
- Display shows “**LO**”. Press **Power Off** button to turn off the washer and unplug and reconnect washer. Press any key to turn on the washer. If “**LO**” is displayed, machine control board and door lock switch should be checked.
- Place washer into **Service Mode** and check for diagnostic codes 4, 18 & 22. See **Service Mode**.
- Check electrical connections at door lock switch assembly and machine control board (CN10). (See “Component Testing Information”).
- Check door lock system. See **Board Output Test**. Check the output voltage of door lock coil. If 120 V present, change door lock switch. If 120 V not present, change machine control board. (See “Component Testing Information”).

Will Not Drain

- Check for restricted drain system.
- In cold climates check for frozen drain hose.
- Check for 120 V at the pump when a spin cycle is selected.
- Check pump motor winding resistance (See “Component Testing Information”). Normal resistance is about 14.2 ohms ($\pm 7\%$).
- Check that the machine control correctly senses the water level in the washer. See **Board Input Test**.
- Check drain pump. See **Board Output Test**.
- Check the machine control board connections at CN10 (Pin 6) for the pump. Should see 120 V. (See “Component Testing Information”).
- Check tub to pump hose for twist in hose.

Wrong Water Temperature

- Check that both faucets are turned on fully.
- Make sure water heater is set to deliver a minimum of 120°F (49°C) hot water at the tap. Also check water heater capacity and recovery rate.
- If the water heater is located a long distance from washer, the water line may need to be purged prior to starting wash cycle.
- Too Hot/Too Cold: This washer uses a reduced amount of water, while the control board meters the incoming flow to regulate the actual temperature of the water in the tub. This may appear to be significantly warmer/cooler than expected.
- Make sure the temperature selection is correct.
- Disconnect inlet hoses from the Water Valve and clean the valve screens of any debris.

Troubleshooting Procedures



WARNING

To avoid risk of electrical shock, personal injury or death, disconnect power to unit before servicing, unless testing requires power.

Vibration/Walking/Noise

- Check for proper load size and distribution.
- Check for proper installation (See Appendix A).
- Verify unit has new motion sensor / control board.
- Check vent flappers for foam present on flapper.
- Check for loose pump to bracket screws.
- Check for stripped pump mounting bolts.
- Check location of top suspension springs.
- Check console for broken plastic locating tabs, check for front panel noise - add foam as needed.
- Check if debris is present in pump causing noise.
- Check dampers / inserts-front/grey, rear/green.
- Clean floor and check condition of rubber feet.
- Do Paper Test - Place paper strips under front feet of washer, pull them out while in **Quick Spin Test** at highest rpm. Adjust feet to hold paper.

Rubber Feet Leaving Marks on Floor

- Use a pencil eraser to remove mark.
- Walk washer into location, do not drag.

Additive Cups Full of Water

- A small amount of water in cups is normal.
- Remove and wash dispenser tray, removable cup, and rinse cap.
- Level washer.

Buttons do not Respond

- Option and Function buttons respond differently according to each cycle.
- Child Lock feature has been selected. To disable feature press and hold **Wash/Rinse Temp** and **Spin Speed** simultaneously until a beep is heard.
- When display shows "00", only the **Power Off** button will function. Press **Power Off** and make new cycle selections.

Consumer Information Codes

If the consumer observes codes on display, see table below.

LED Display	Description	Diagnostic code
nd	The water level fails to drop below the Low Water level reset within 15 minutes, before a spin begins.	1
LO	Door failed to unlock after 3 attempts.	2
nF	Continuous fill of 12 minutes. Total fill of 14 minutes.	3

LED Display	Description	Diagnostic code
FL	Door failed to lock after 3 attempts.	4
LE	Water sensor level fault.	8
OE	A fault is detected in the water level sensor. Data (frequency) shows the water level is at or above the overflow level.	E
E2	A key is sensed to be pressed more than 30 seconds, the key will be assumed to be stuck.	15
dc	Never exceeded 400 rpm due to an unbalanced load.	10
od	The door has not been opened after two complete wash cycles. Door switch was not seen open since the last two final spins.	17
dL	Open door lock switch with motor running.	18
dS	Door switch is read as open and the door locked switch is read as locked.	22
bE	Motor tach signal exists without motor running.	25
tE	Abnormal high/low temp or ohm resistance seen.	29
E3	Machine control is attempting to drive the motor but is not seeing any tach response. Visual check shows motor is not moving. (Locked, Hall Sensor fault).	2E
Sr	System Relay failure.	34
3E	Over Current is detected. Motor won't turn.	3E
2E	Voltage for motor control bus is over specified limit.	91
2E	Voltage for motor control bus is under specified limit.	92

Troubleshooting Procedures



WARNING

To avoid risk of electrical shock, personal injury or death, disconnect power to unit before servicing, unless testing requires power.

Service Mode

Service Mode enables service personnel to verify the operation of the washing machine and diagnose problems. **Service Mode** can be entered in the middle of any wash cycle without interrupting the cycle. While in **Service Mode**, the technician can cancel the current cycle, set a continuous running mode, start a variety of special service tests and view diagnostic displays.

Enter / Exit Service Mode

To enter **Service Mode** press the **Chime** and **Extra Rinse** keys for 3 seconds or until the control beeps.

NOTE: The washer must be 'ON' before **Service Mode** can be entered.

The motor speed will be displayed when started (motor not running display will be "0"). The present state of the machine will not be changed (i.e., the current cycle in progress will not be interrupted and only the display will change). All LED's will be turned 'OFF' except the **Door Lock** LED; it will continue to display the condition of the door lock.

To exit **Service Mode**:



- 1) Press **Chime** and **Extra Rinse** keys for 3 seconds again, or
- 2) Press **Power Off** button, or
- 3) Unplug the machine.





To pause while in **Service Mode**:

Pressing the **Rotary Cycle Selector** knob while running a test will pause the individual test.

Access Service Tests and Diagnostic Features while in Service Mode.

The following table summarizes special tests and features available in **Service Mode**, along with methods of activation and cancellation. A more detailed description of each test can be found in the text following the table. Reference the text or symbol indicated in the "Test or Display" column, with the text and symbols indicated in the text following the quick reference table for a more detailed explanation.

Test or Display	To Start (or Hold)	To Cancel (or resume)
 Quick Spin Test	Press Delay Start and Rinse & Spin	Press Delay Start and Rinse & Spin or press Power Off
 Hold Quick Spin Test step	Press Rotary Cycle Selector (during test)	Press Rotary Cycle Selector
 Fast Time-Down Test / Advance to next step	Press Wash/Rinse Temp to start test. Press Wash/Rinse Temp during cycle to advance.	Press Power Off

Test or Display	To Start (or Hold)	To Cancel (or resume)
 Quick Service Cycle	Press Wash/Rinse Temp and Soil Level	Press Power Off (also exits Service Mode)
Hold Quick Service Cycle Step	Press Rinse & Spin and Spin & Drain together	Press Rinse & Spin and Spin & Drain
 LED/Switch Test	Press Delay Start for 3 seconds (then individual buttons to test) Turn Rotary Cycle Selector clockwise, the LED's around it will be toggled. Turn Rotary Cycle Selector counterclockwise, the 7-segment LED's toggle. Press Rotary Cycle Selector , all of the LED's around the Rotary Cycle Selector will be toggled.	Press Power Off twice after starting test
 Board Input Test	Press Spin & Drain	Press Spin & Drain
 Board Output Test / System Check	Press Spin Speed	Press Power Off .
Diagnostic Code Display (Initial)	Press Rinse & Spin – displays 'd'	Press Rinse & Spin again
All Diagnostic Codes	Rotate Rotary Cycle Selector either direction	N/A
Cycle Count No. for Diagnostic Code	Press and hold Rotary Cycle Selector , while diagnostic code is displayed	Release Rotary Cycle Selector (returns to diagnostic code display)
Clear All Diagnostic Codes	Press Delay Start and Chime together while displaying diagnostic codes	N/A
Display Software Version	Press Soil Level . Press 2 times for displays with only 2 character positions.	Press Soil Level a 3 rd time.
Cycle Count	Press Chime	N/A

Troubleshooting Procedures

WARNING

To avoid risk of electrical shock, personal injury or death, disconnect power to unit before servicing, unless testing requires power.



Quick Spin Test

While in **Service Mode**, press **Delay Start** and **Rinse & Spin** keys to start a **Quick Spin Test**. **Quick Spin Test** steps follow:

- Start spinning, and after reaching a maximum spin speed...
- Stay at maximum spin speed for 2 minutes and stop **Quick Spin Test**.

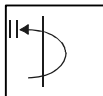

Hold Quick Spin Step

If the **Rotary Cycle Selector** knob is pressed during the **Quick Spin Test**, the

machine will hold at the next highest index speed for up to 10 minutes. At the end of 10 minutes, the machine will resume and finish the **Quick Spin Test**. To cancel the 'Hold' and allow the **Quick Spin Test** to continue, press the **Delay Start** and **Rinse & Spin** keys.



Fast Time Down Test

While any test or cycle is running in **Service Mode**, pressing the

Wash/Rinse Temp key will advance the program to the next cycle stage. Cycle stages are located at key locations in the machine operation. As the program is advanced it will index as follows: The end of each fill (the same as the beginning of a tumble session for Wash, or Rinse); at the beginning of a drain session; at the beginning of a spin session (at this position, check the water level, if over reset level, drain first before entering the spin function); at the beginning of a fill session; at the beginning of Bleach fill; at the beginning of Fabric Softener fill; and every 3 minutes during the tumble sessions (Wash, and Rinses).



Quick Service Cycle

While in **Service Mode**, pressing the **Wash/Rinse Temp** and **Soil Level** keys for

3 seconds will start a **Quick Service Cycle**. This will be a quick check of all systems. If display shows "od" then open and close door. Pressing **Spin Speed** key will advance to the next cycle. The following steps are performed: Display shows "SC".

1. Hot water for 5 seconds and then turn off.
2. Cold water for 5 seconds and then turn off.
3. Bleach valve for 5 seconds and then turn off.
4. Dispenser softener using cold water and bleach water for 5 seconds and then turn off.
5. Turn on Cold valves until the control detects proper water level. During this time, tumble at 45 rpm for 5 seconds in a clockwise direction, pause for 2 seconds, tumble at 45 rpm for 5 seconds in a counterclockwise direction, pause for 2 seconds. Continue pattern until the water level is detected. Minimum time for this segment to be 5 seconds.

After water height is achieved, continue tumble pattern for another 14 seconds. If the washer is equipped, turn on heater for first 5 seconds of this tumble pattern. Advance the washer to next step if water is not connected to machine.

6. Drain and spin to maximum speed. Machine will achieve maximum speed using the safest, fastest method.
7. Display a "PA" (Passed) continuously for 5 seconds if no diagnostic codes were logged during the test. Washer will return to the normal **Service Mode** at the end of the 10 second period.

The "SC" in the display will blink as an indication of failure, and continue blinking until the **Quick Service Cycle** test has reached the end. Any diagnostic code logged during this test will result in failure of the test, but will not necessarily stop the test. During the **Quick Service Cycle**, pressing the **Spin Speed** key will advance to the next step. Pressing the **Rinse & Spin** and **Spin & Drain** keys will suspend the machine at the current step for up to 10 minutes or until **Delay Start** and **Chime** keys are pressed. All LED's should flash 'ON' and 'OFF' while the system is suspended or on hold.



LED/Switch Test

While in **Service Mode**, press the **Delay Start** key to start a **LED/Switch Test**. All the LED's can be toggled or slewed by pressing the key associated with the LED or set of LED's. All keys (including the **Power Off** button) must be pressed within 5 minutes for this test to pass. "PA" will be displayed for five (5) seconds once all keys have been pressed and the test is completed. Following 20 seconds of inactivity at any point, this test will exit without any display. The **Power Off** button must be pressed twice within 30 seconds to cancel this test.

Switch	Action
Delay Start	Press once
Chime	Press 3 times
Extra Rinse	Press once
Soil Level	Press 4 times
Spin Speed	Press 5 times
Wash/Rinse Temp	Press 5 times
Rinse & Spin	Press once
Spin & Drain	Press once
Rotary Cycle Selector	Rotate 1 full revolution clockwise
Rotary Cycle Selector	1 position counterclockwise
Rotary Cycle Selector	Press once
Power Off	Press once

Troubleshooting Procedures



WARNING

To avoid risk of electrical shock, personal injury or death, disconnect power to unit before servicing, unless testing requires power.

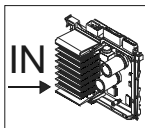

Board Input Test

While in **Service Mode**, pressing the **Spin & Drain** key will begin the **Board Input Test**. This test turns on a specified output after a key press. Pressing the **Spin & Drain** key again cancels the test. (Display shows "in"). While in **Service Mode** follow chart to check respective function.

- When the **Rotary Cycle Selector** knob is set to "Super Wash" and the **Rotary Cycle Selector** knob is pressed, the door position will be displayed: "0P" if open, "CL" if closed.
- When the **Rotary Cycle Selector** knob is set to "Normal" and the **Rotary Cycle Selector** knob is pressed, the Lock position will be displayed: "UL" if unlocked, "LO" if locked.
- When the **Rotary Cycle Selector** knob is set to "Quick Wash" and the **Rotary Cycle Selector** knob is pressed, the High water level will be displayed: "0" if below level, "1" if above level. The High water level is defined as the over flow water level.
- When the **Rotary Cycle Selector** knob is set to "Wrinkle Control" and the **Rotary Cycle Selector** knob is pressed, the Medium water level will be displayed: "0" if below level, "1" if above level. The Medium water level is defined as the minimum water level needed such that the heater can be turned 'ON' (only MAH8700* and MAH9700* models have heaters).
- When the **Extra Rinse** key is pressed, the Low water level will be displayed: "0" if below level, "1" if above level. The Low water level is defined as the reset water level.
- When the **Rotary Cycle Selector** knob is set to "Hand Wash" and the **Rotary Cycle Selector** knob is pressed, the level of Tub unbalance will be displayed: "UC" if balanced, "U0" if unbalanced. "U0" will be displayed during the time when the machine is correcting for the unbalance; e.g. slowing down to redistribute the load or to get to a lower spin speed. Once the situation has been corrected (i.e. the load has begun tumbling or the lower speed has resulted in an acceptable amount of balance); "UC" will once again be displayed.
- When the **Delay Start** key is pressed, the water temperature will be displayed in Degrees F (Fahrenheit).
- When the **Rotary Cycle Selector** knob is set to "Delicates" and the **Rotary Cycle Selector** knob is pressed, the water temperature will be displayed in degrees C (Celsius).

While performing the **Board Input Test** in **Service Mode**, follow this quick reference chart to check respective functions.

Selection	Function	Display
Rotary Cycle Selector set to "Super Wash". Press Rotary Cycle Selector .	Door position	"0P" or "CL"
Rotary Cycle Selector set to "Normal". Press Rotary Cycle Selector .	Lock state	"UL" or "LO"
Rotary Cycle Selector set to "Quick Wash". Press Rotary Cycle Selector .	High water level	"0" if below level. "1" if above level.
Rotary Cycle Selector set to "Wrinkle Control". Press Rotary Cycle Selector .	Medium water level	"0" if below level. "1" if above level.
Press the Extra Rinse key.	Low water level	"0" if below level. "1" if above level.
Rotary Cycle Selector set to "Hand Wash". Press Rotary Cycle Selector .	Tub balance	"UC" if Balanced. "U0" if Unbalanced
Press Delay Start key.	Water temperature	Degrees F
Rotary Cycle Selector set to "Delicates". Press Rotary Cycle Selector .	Water temperature	Degrees C

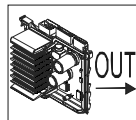

Board Output Test

While in **Service Mode**, pressing the **Spin Speed** key will begin the **Board Output Test**. This test turns 'ON' a specified output after a key press. Pressing the **Spin Speed** key again cancels the test. Only one output can be 'ON' at any time. All outputs will be turned 'OFF' after five (5) minutes of inactivity.

- When the **Rotary Cycle Selector** knob is set to "Super Wash" and the **Rotary Cycle Selector** knob is pressed, the main relay will be toggled (either from 'ON' to 'OFF' or from 'OFF' to 'ON').

Troubleshooting Procedures



WARNING

To avoid risk of electrical shock, personal injury or death, disconnect power to unit before servicing, unless testing requires power.

- When the **Rotary Cycle Selector** knob is set to “Normal” and the **Rotary Cycle Selector** knob is pressed, the hot water valve will be turned ‘ON’. This output will remain ‘ON’ until the **Rotary Cycle Selector** knob is pressed again to turn ‘OFF’ the output. The control will not allow the machine to fill past the High water level.
- When the **Rotary Cycle Selector** knob is set to “Wrinkle Control” and the **Rotary Cycle Selector** knob is pressed, the cold water valve will be turned ‘ON’. This output will remain ‘ON’ until the **Rotary Cycle Selector** knob is pressed again to turn ‘OFF’ the output. The control will not allow the machine to fill past the High water level.
- When the **Rotary Cycle Selector** knob is set to “Delicates” and the **Rotary Cycle Selector** knob is pressed, the bleach valve will be turned ‘ON’. This output will remain ‘ON’ until the **Rotary Cycle Selector** knob is pressed again to turn ‘OFF’ the output. The control will not allow the machine to fill past the High water level.
- When the **Rotary Cycle Selector** knob is set to “Hand Wash” and the **Rotary Cycle Selector** knob is pressed, the fabric softener fill valve and the cold water valve will be turned ‘ON’ to check the fabric softener fill. This output will remain ‘ON’ until the **Rotary Cycle Selector** knob is pressed again to turn ‘OFF’ the output. The control will not allow the machine to fill past the High water level.
- When the **Rotary Cycle Selector** knob is set to “Quick Wash” and the **Rotary Cycle Selector** is pressed, the drain pump will be turned ‘ON’. This output will remain ‘ON’ until the **Rotary Cycle Selector** knob is pressed again to turn ‘OFF’ the output.
- Pressing the **Delay Start** key will turn ‘ON’ the motor and the **Delay Start** LED. This output and the LED will remain ‘ON’ until the **Delay Start** key is pressed again to turn ‘OFF’ the output. When activated, the machine will tumble for 5 seconds in the CW direction, pause for 2 seconds, tumble in the CCW direction for 5 seconds, pause for 2 seconds; repeating this pattern until **Delay Start** key is pressed again to turn ‘OFF’ the tumbling.

Note: All tumble speeds are assumed to be 45 rpm.

- Pressing the **Chime** key will unlock the door and turn ‘ON’ all the LED’s above the **Chime** key. This output will attempt to unlock one time, if safe to do so.
- Pressing the **Wash / Rinse Temp** switch pad will lock the door and all the **Wash / Rinse Temp** LED’s will turn ‘ON’. Pressing the **Chime** key will unlock the door and the all the **Chime** LED’s will turn ‘ON’.

While performing the **Board Output Test in Service Mode**, follow this quick reference chart to check respective function.

Selection	Component	Function
Rotary Cycle Selector set to “Super Wash”. Press Rotary Cycle Selector .	Main Relay	‘ON’ to ‘OFF’ or ‘OFF’ to ‘ON’
Rotary Cycle Selector set to “Normal”. Press Rotary Cycle Selector .	Hot Water Valve	1 st press valve on. 2 nd press valve ‘OFF’.
Rotary Cycle Selector set to “Wrinkle Control”. Press Rotary Cycle Selector .	Cold Water Valve	1 st press valve on. 2 nd press valve ‘OFF’.
Rotary Cycle Selector set to “Delicates”. Press Rotary Cycle Selector .	Bleach Valve	1 st press valve on. 2 nd press valve ‘OFF’.
Rotary Cycle Selector set to “Quick Wash”. Press Rotary Cycle Selector .	Drain Pump	1 st press Drain Pump on. 2 nd press Drain Pump ‘OFF’.
Press Delay Start	Motor	1 st press Motor on. 2 nd press Motor ‘OFF’.
Press Chime	Door Lock	1 Attempt to unlock
Press Wash / Rinse Temp	Door Lock	Lock Door
Rotary Cycle Selector set to “Hand Wash”. Press Rotary Cycle Selector .	Fabric Softener Valve and Cold Water Valve	1 st press Fabric Softener fill. 2 nd press valves ‘OFF’

Troubleshooting Procedures



WARNING

To avoid risk of electrical shock, personal injury or death, disconnect power to unit before servicing, unless testing requires power.

Display Diagnostic Codes

The diagnostic code display can be toggled 'ON' and 'OFF' from **Service Mode** by pressing the **Rinse & Spin** key and rotating the **Rotary Cycle Selector** knob. The display will show a "d".

Rotating the **Rotary Cycle Selector** knob in either direction will cycle through the list of codes one code at a time with no wrap. Once an initial direction is selected by the user (either Clockwise or Counterclockwise), subsequent movements of the knob in the same direction will show older codes. If the user changes direction and turns the **Rotary Cycle Selector** knob in the opposite direction, the more recent code will be displayed. If rotation is continued to the limits of the list, the display will remain at the top or the end of the list. A pair of dashes "- -" will be displayed at the end of the list of codes, when the control reaches the top, it will again show "d".

A code generated during the current cycle will be displayed with the **Spin Speed** LED turned 'ON'. If no cycle is currently running, a code generated during the previous cycle will be displayed with the **Spin Speed** LED turned 'ON'.

Access Other Features

While a diagnostic code is displayed, if the **Rotary Cycle Selector** knob is pressed and held, the machine will display the number of cycles since the diagnostic code occurred.

Clear Diagnostic Codes

To clear the diagnostic codes list, press the **Delay Start** and **Chime** keys for 3 seconds while viewing the list.

Diagnostic Codes

Diag. Code	Description	Trigger	Action to be taken
1	No Drain	The water level fails to drop below the Low Water level reset within 15 minutes, before a spin begins.	Displays "nd". See Will Not Drain "Troubleshooting Procedures"
2	The door fails to unlock	Door failed to unlock after 3 attempts	Displays "LO". See Will Not Unlock "Troubleshooting Procedures"
3	No Fill	Continuous fill of 12 minutes. Total fill of 14 minutes.	Displays "nF". See No Water Fill "Troubleshooting Procedures"

Diag. Code	Description	Trigger	Action to be taken
4	The door/lid fails to lock	Door failed to lock after 3 attempts	Displays "FL". See Will Not Lock "Troubleshooting Procedures".
5-7	Not Used		
8	Water level sensor fault.	Input signal from water level sensor is out of range, Washer will beep and pause the wash cycle.	Displays "LE". See No Water Fill "Troubleshooting Procedures".
9	Not Used		
10	Unbalance or cabinet hit detected during final spin, which prevented the spinner from exceeding 400 rpm	Never exceeded 400rpm due to an unbalance load.	Will display "dc" See Wet Clothes "Troubleshooting Procedures "
E	Water sensor level fault.	Water level in the machine is believed to be above the overflow level. When this condition is detected, the machine will automatically begin pumping water out until it falls below the overflow level.	First check to see that water valve is not stuck. If water valve is OK, check water level sensor
11	Will not remember machine settings	Difficulty in reading memory	See Clear Diagnostic Codes . Disconnect and reconnect the washer power cord at power supply outlet. If condition still exists, replace machine control board.
12-14	Not Used		

Troubleshooting Procedures



WARNING

To avoid risk of electrical shock, personal injury or death, disconnect power to unit before servicing, unless testing requires power.

Diag. Code	Description	Trigger	Action to be taken
15	Stuck Key	A key is sensed to be pressed more than 30 seconds, the key will be assumed to be stuck	Display "E2". See Membrane Pad Check . Check connection of keypad to control board. Replace console if necessary.
17	Door/Lid switch was not seen open since the last two final spins	The door has not been opened after two complete wash cycles. Door switch was not seen open since the last two final spins	Will display "od". If door open sensed, error will clear. Check door lock
18	Detected door lock switch open during cycle when not expected.	Open door lock switch with motor running.	Check for loose wire connections. Clear the diagnostic code and recheck; if reoccurs, see Door Lock Test . Check door lock system. See Board Output Test . Check the output voltage of door lock coil. If normal, change door lock switch. If not normal, change Machine Control Board.
19-21	Not Used		
22	Door/lid switch detected open during cycle (when not paused).	Door switch is read as open and the door locked switch is read as locked.	See Door Lock Test "Troubleshooting Procedures"
23-24	Not Used		
25	Motor tach signal exists without motor running.	Tach signal exists without torque command or when not expected.	Displays "bE". Replace Motor Control Board.
26-28	Not Used		
29	Sump thermistor failure (Optional)	Abnormal high/low temp or ohm resistance seen	Displays " tE". - Loose or pinched wires - Bad sump thermistor

Diag. Code	Description	Trigger	Action to be taken
30-33	Not Used		
2E	Motor Drive failure (Locked, Hall sensor fault)	Machine control is attempting to drive the motor but is not seeing any tach response. Visual check shows motor is not moving.	Display "E3" Evaluate wire harness for loose or unhooked connections. If machine has separate motor control, perform self diagnostic motor test. See "Board Output Test"
34	System Relay failure	Machine control does not see relay open when it should.	Display "Sr". Replace machine control board.
35	Not Used		
3E	Motor failure (Over current)	Over Current is detected. Motor won't turn.	Displays "3E". Check the motor windings, the speed sensor, wiring connections, or Control Board.
40-49	Not Used		
91	Voltage for motor control bus is over specified limit	Voltage for motor control bus is over limit	Display "2E". Replace Machine Control Board.
92	Voltage for motor control specified limit	Voltage for motor control bus is under specified limit	Display "2E". Replace Machine Control Board.

Exit Service Mode

To exit:





- 1) Press **Chime** and **Extra Rinse** keys for 3 seconds again, or
- 2) Press Off, or
- 3) Unplug the machine. After five (5) minutes of inactivity (user key presses) in Service Mode, the machine will exit the Service Mode and resume normal operations. Pressing the **Power Off** key will completely exit Service Mode. If a cycle is running, cancel the cycle. Pressing the **Rotary Selector** knob while running a test will pause the individual test, while remaining in Service Mode. A power loss during Service Mode will cancel this mode.

Component Testing Information

⚠ WARNING

To avoid risk of electrical shock, personal injury or death, disconnect power to unit before servicing, unless testing requires power.

NOTE: See “Machine Control Board” on next page for pin and connector locations.

Illustration	Component	Test Procedure	Results
	Thermistor	Unplug harness connector and test from wire insertion side of connector. Pin #6 and Pin #3 of CN3	13K ohms
	Door Switch	Check voltage at Pin #6 and Pin #4 of CN3..... Unplug harness connector and test from wire insertion side of connector. Pin #7 of CN10 and Pin #3 of CN5..... Pin #8 of CN10 and Pin #3 of CN5.....	Door Open = 5V DC Door Closed = 0V DC 60 ohms 60 ohms
	Water Sensor	Check voltage and frequency at Pin #6 and Pin #7 of CN3..... Check voltage and frequency at Pin #6 and Pin #8 of CN3.....	Reset water level = 2.5V DC, 25.8 KHz Reset water level = 2.5V DC, 25.8 KHz
	Sump Sensor	Check voltage at Pin #4 and Pin #3 of CN8.....	0V DC or 3.75V DC
	Motor	Unplug harness connector and test from wire insertion side of connector. Pin #1 and Pin #2 of CN9..... Pin #1 and Pin #3 of CN9..... Pin #2 and Pin #3 of CN9..... Any 2 Pins (1,2,3) on Motor Connector	3.0 ohms 3.0 ohms 3.0 ohms 3.0 ohms
	Drain Pump	During drain check voltage at Pin #1 of CN5 and Pin #6 of CN10.....	120V AC
	Water Valves	Check voltage at Pin #1 and Pin #1,2,4 of CN10..... Unplug harness connector and test from wire insertion side of connector. (Hot valve) Pin #2 of CN10 and Pin #1 of CN7..... (Fabric Softener Fill valve) Pin #4 of CN10 and Pin #1 of CN7..... (Main valve) Pin #1 of CN10 and Pin #1 of CN7.....	120V AC when each valve operates 1100 ohms 1100 ohms 1100 ohms
	AC Power	Check voltage at Pin #1 and Pin #3 of CN5..... Check voltage at Pin #1 of CN5 and Pin #1 of CN6.....	120V AC 120V AC
	Reactor	Unplug harness connector and test from wire insertion side.....	Less than 1 ohm
	MEMS Sensor	Check voltage at Pin #1 and Pin #5 of CN11..... Check voltage at Pin #1 and Pin #4 of CN11.....	Approximately 2.5V (2.2V – 2.8V) Approximately 2.5V (2.2V – 2.8V)

Component Testing Information

WARNING

To avoid risk of electrical shock, personal injury or death, disconnect power to unit before servicing, unless testing requires power.

Machine Control Board

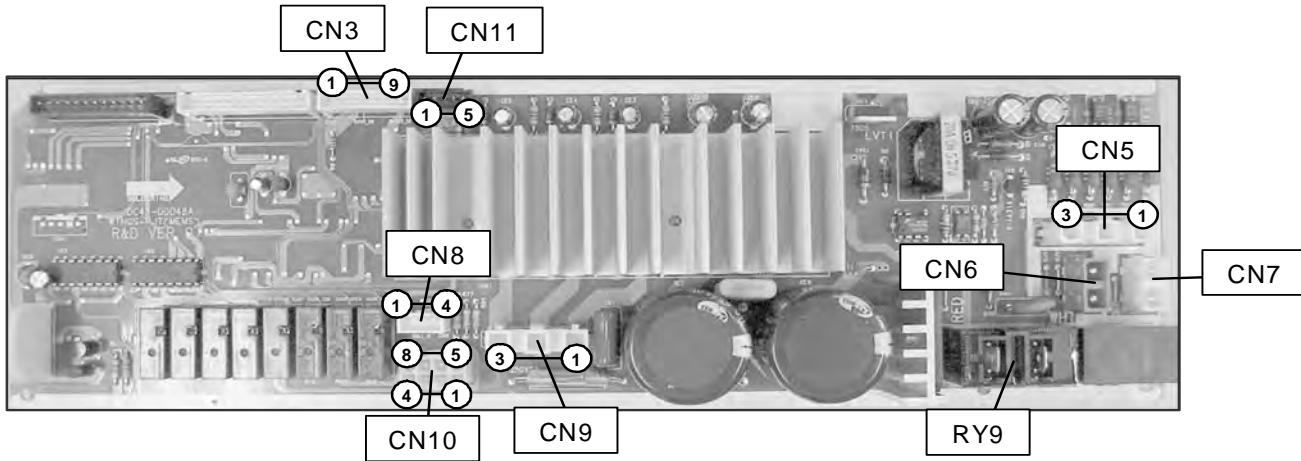

MEMS Sensor

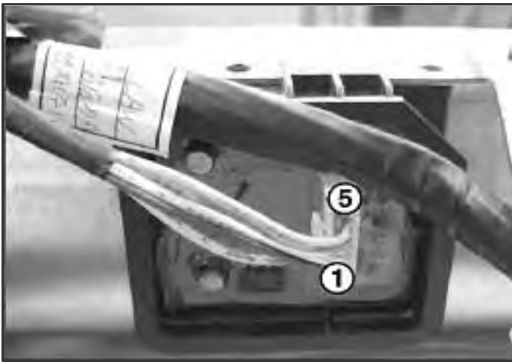

Motor

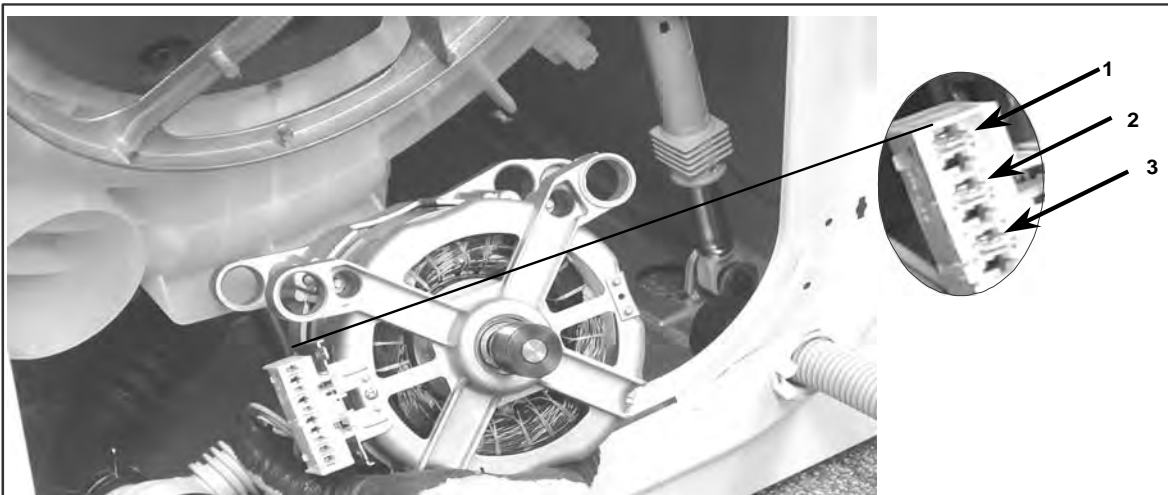

Normal resistance is approximately 3.0 ohms between any 2 pins (1,2 or 3)

Component Testing Information



WARNING

To avoid risk of electrical shock, personal injury or death, disconnect power to unit before servicing, unless testing requires power.

Note: The heater will not turn on more than once in a wash cycle (no reheating).

ATC Control

When ATC cold wash is selected, the Heater turns on if the water temperature in the tub is below 60 degrees F. The heater turns off when the water temperature is above 70 degrees F or time has expired for the wash cycle. The cycle time will **not** be extended to reach the desired temperature.

When ATC warm wash is selected, the heater turns on if the water temperature in the tub is below 95 degrees F. The heater will turn off when the water temperature is above 105 degrees F or time has expired for the wash cycle. The cycle time will **not** be extended to reach the desired temperature.

When hot wash is selected, the heater will turn on if the water temperature in the tub is below 120 degrees F. The heater turns off when the water temperature is above 130 degrees F. or or time has expired for the wash cycle. The cycle time will **not** be extended to reach the desired temperature.

When the Sanitary Cycle is selected, the heater turns on if the water temperature in the tub is below 141 degrees F. The heater turns off when the water temperature is above 151 degrees F. The wash cycle will be extended to achieve the temperature of 151 degrees F.

Water flow through dispenser during Wash fill

WASH					
DRAIN	FILL / Rotation of Spinner	(HEATING)	WASHING	COOLING / DISENTANGLE	SUB TOTAL

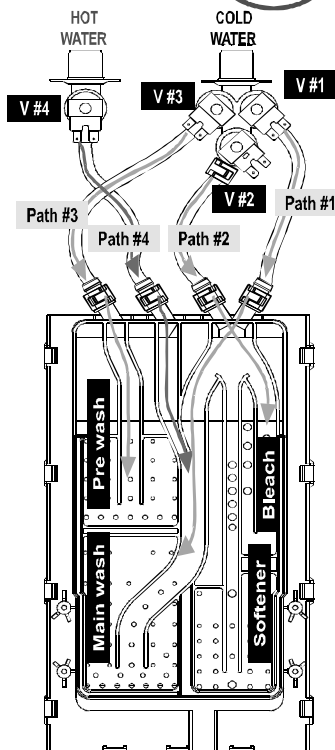

First minute of fill with no water in tub (*Reset Level – 25.6 kHz*). Valve #3 opens and cold water flows through path #3 to detergent compartment (Pre wash).

Specified Water Level (Final Water Level) for each cycle

1. If ATC (warm or cold) is selected, valves #1 and #4 open as needed to achieve specified water temperature. Cold water flows through path #1 and hot water through path #4 to the detergent compartment
2. If NON-ATC is applied,
 - If "HOT wash" is selected, valve #4 opens and water flows through path #4.
 - If "COLD wash" is selected, Valve #1 opens and cold water flows through path #1.

Cold wash and rinse, Non ATC: water temperature will be tap cold
 Cold wash, ATC: water temperature = 65 °F±10°F
 Warm wash, ATC: water temperature = 105 °F±10°F
 Warm Rinse, ATC: water temperature = 80 °F±10°F
 for final rinse only, all other rinses will be "tap cold"
 Hot Wash, Non ATC: water temperature will be tap hot

Component Testing Information



WARNING

To avoid risk of electrical shock, personal injury or death, disconnect power to unit before servicing, unless testing requires power.

Water flow through dispenser during Rinse 1 fill

RINSE 1					
DRAIN	MIDTERM SPIN	FILL / Rotation of Spinner	RINSE	DISENTANGLE / FILLING TO REMOVE SUDS	SUB TOTAL

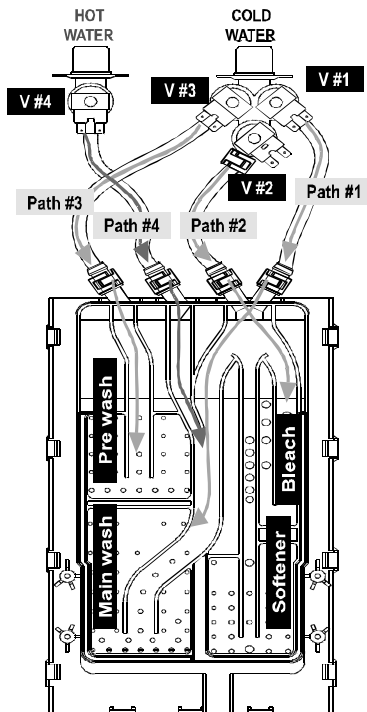

From NO water level (Reset Level) to the specified (final) water level.

Valves #2 and #3 open, and cold water flows through paths 2 and 3, to the detergent compartment.

In order to fill "Bleach", Valve #2 opens and cold water flows through path #2 to the Bleach compartment.

Component Testing Information

⚠ WARNING

To avoid risk of electrical shock, personal injury or death, disconnect power to unit before servicing, unless testing requires power.

Water flow through dispenser during Rinse 2 fill

RINSE 2					
DRAIN	MIDTERM SPIN	FILL / Rotation of Spinner	RINSE	DISENTANGLE / FILLING TO REMOVE SUDS	SUB TOTAL

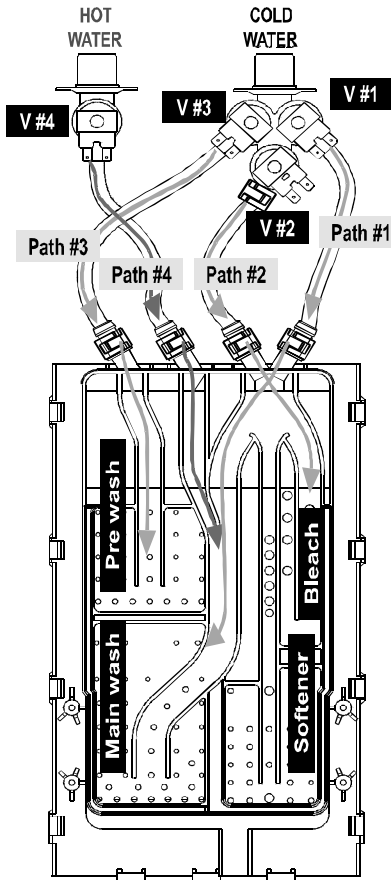

From no water level (Reset Level) to 1st sensing level (25.1kHz):

Valves #1 & #2 open at the same time. Cold water from valves #1 & #2 mix and fill Main wash/Softener/Bleach compartments.

Valve #1 & #2 are opened for 1st 9 seconds and closed for 15 seconds, After that, they are opened again to 1st sensing water level.

From 1st sensing level to specified water level for each cycle:

In order to meet the ATC temperature specification, the hot water valve & cold water valve #1 are opened as needed.

Finally, in order to remove the remaining water in the Bleach tray, Cold water valve #2 is opened for 8 seconds.

1st Water Sensing Level

- Wrinkle Control & Quick Wash – 24.9 kHz
- Others – 25.1 kHz

Disassembly Procedures



WARNING

To avoid risk of electrical shock, personal injury or death; disconnect power to unit before servicing.

Top Cover Removal

1. Disconnect power supply to unit.
2. Remove 2 10mm screws from washer back.



3. Slide Top Cover towards the rear to clear the screw head from flange on the bottom side of the Top Cover.

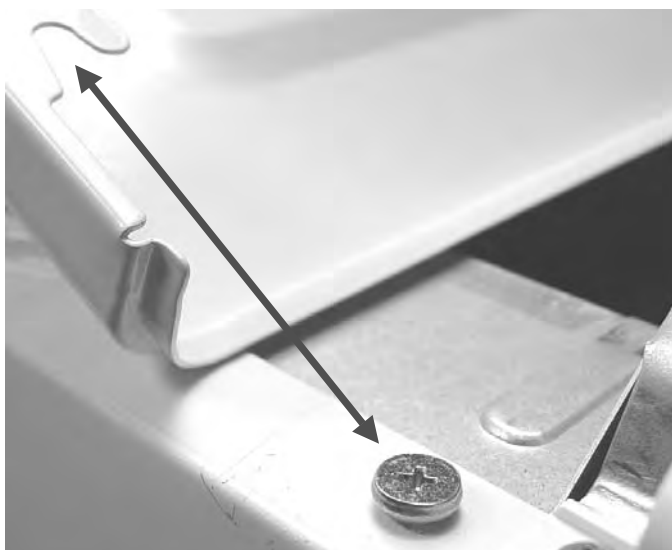

Water Level Sensor Removal

1. Disconnect power supply to unit.
2. Remove Top Cover.

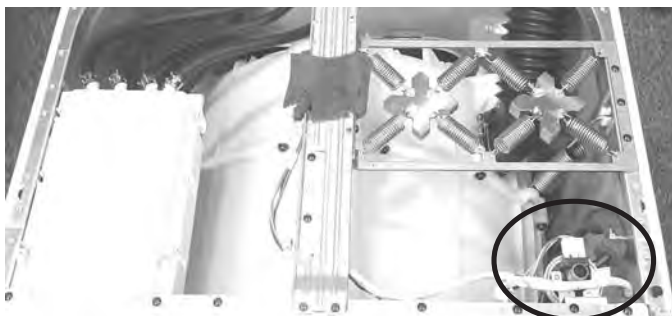

3. Remove harness plug.

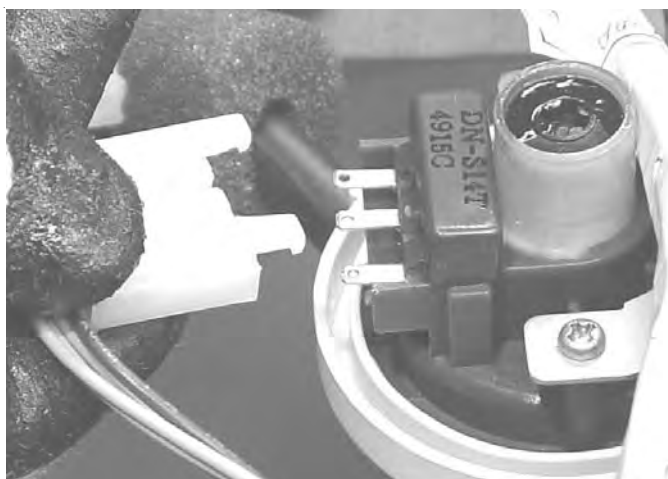

4. Remove Pressure Hose.



5. Remove single attachment screw.



Disassembly Procedures



WARNING

To avoid risk of electrical shock, personal injury or death; disconnect power to unit before servicing.

MEMS Sensor Removal

1. The motion sensor/bracket assembly goes between the cross brace and upper plate on one side and over the tab on the plastic control panel, on the other side. The motion sensor wire harness attaches to location CN11 on control board.

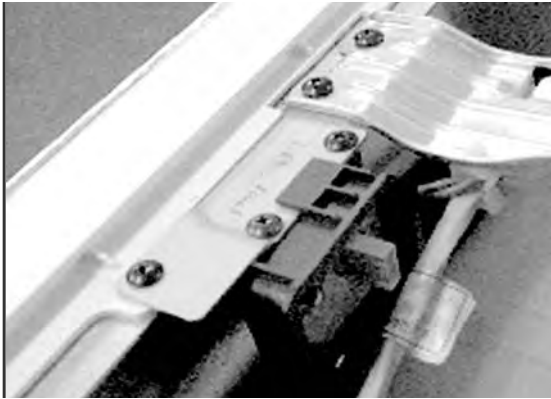

Reactor Removal

1. Disconnect power supply to unit.
2. Remove Top Cover (See "Top Cover Removal").
3. Remove single attachment screw on cross brace.



4. Twist Reactor counterclockwise to remove.

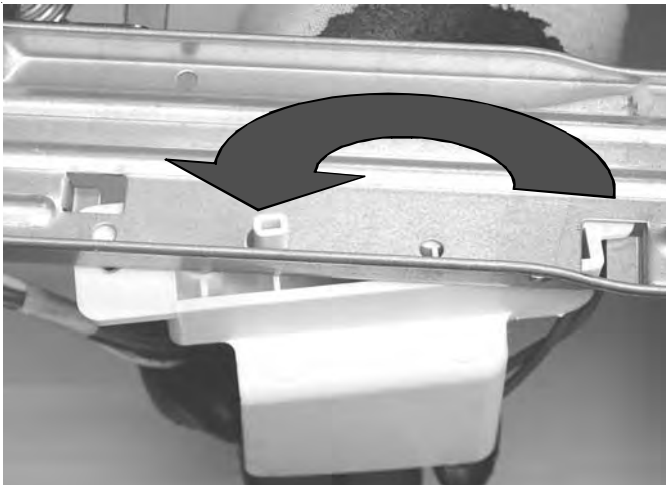

NOTE: The reactor coil is wired in series with line 1 internally in the Control Board. An open coil or loose electrical connection would result in a "dead" board complaint. A resistance check across the coil leads should indicate less than 1 ohm.

EMI Filter Removal

1. Disconnect power supply to unit.
2. Remove Top Cover (See "Top Cover Removal").
3. Loosen 13mm acorn nut and slide EMI Filter out of bracket.

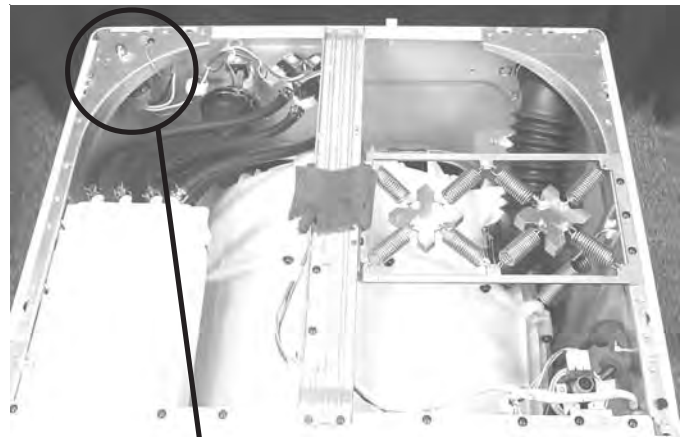

NOTE: Mark the wire locations on the EMI before removing the terminals.

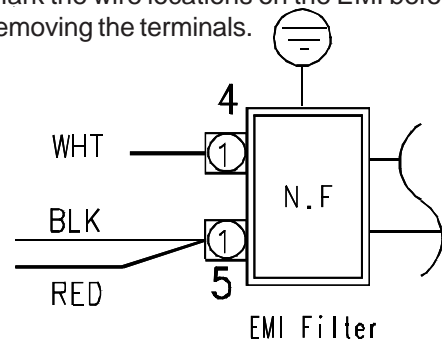

Disassembly Procedures



WARNING

To avoid risk of electrical shock, personal injury or death; disconnect power to unit before servicing.

Water Valve Removal

1. Disconnect power supply to unit.
2. Remove Top Cover.
3. Remove two screws each hot and 3 valve combo cold valve.



4. Remove hose clamps and hoses.



NOTE: The hose circuitry is marked on the Dispenser top.

Dispenser Removal

1. Disconnect power supply to unit.
2. Depress the release tab and slide drawer from washer.



3. Remove Top Cover (See "Top Cover Removal").
4. Remove clamps and hoses from dispenser.

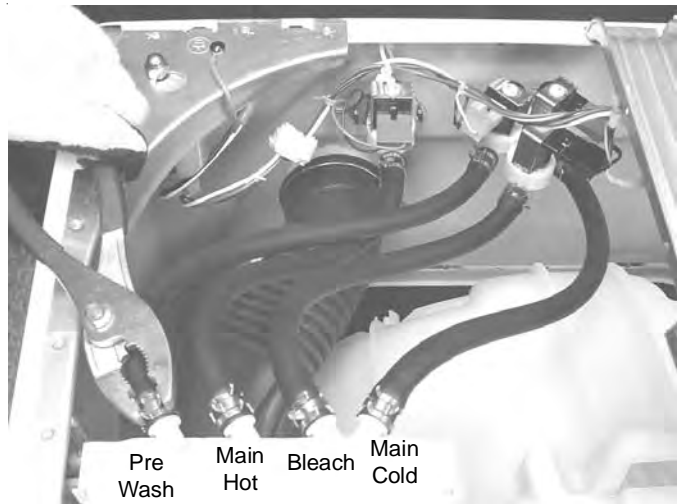

NOTE: The hose circuitry is marked on the Dispenser top.

Disassembly Procedures

 **WARNING**

To avoid risk of electrical shock, personal injury or death; disconnect power to unit before servicing.

- Remove attachment screws and lift dispenser to expose fill hose.

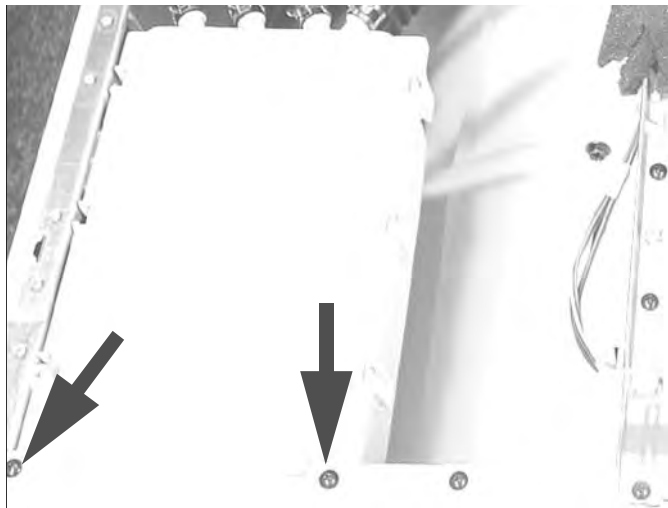

- Remove fill hose clamp and hose.



- Tilt the panel forward enough to grasp with your left hand, then gently hit the lower right corner of the panel to unhook it from the cabinet. Repeat the process for the left side of the panel. Roll Console down and lift away from washer.

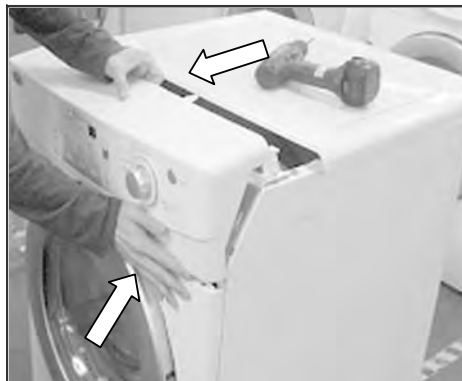

- Remove Reactor wire from wire clip.



- Remove the Reactor wire harness connectors from the PCB Board.
- Remove five screws from PCB Housing to access the LED Circuit Board.

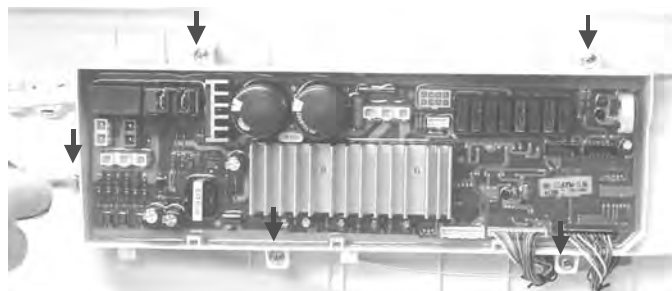

Console Removal

- Disconnect power supply to unit.
- Remove Top Cover (See "Top Cover Removal").
- Remove Dispenser (See "Dispenser Removal").
- Remove five screws attaching Console.



Door Removal

- Disconnect power supply to unit.
- Remove four screws to remove door from Front Panel.

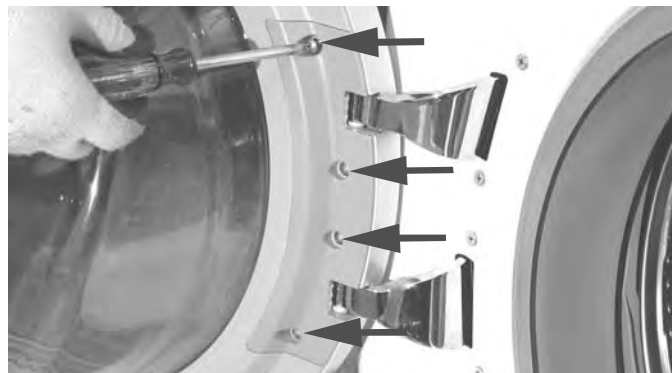

Disassembly Procedures



WARNING

To avoid risk of electrical shock, personal injury or death; disconnect power to unit before servicing.

3. Remove hinge retainer plate.

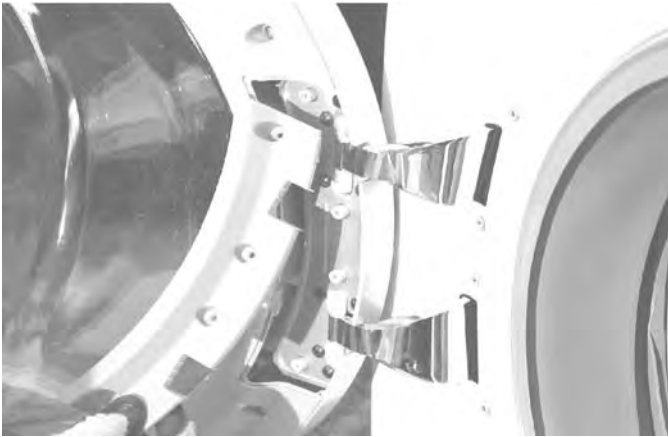

4. Remove door from hinge posts.

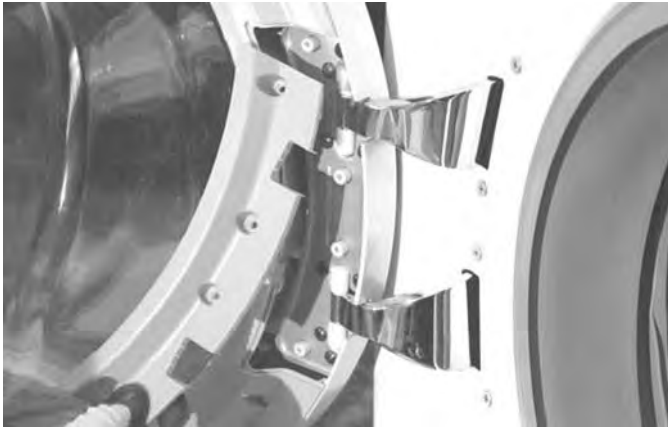

5. Remove screws around the perimeter of the glass retainer.



6. Remove the glass retainer.

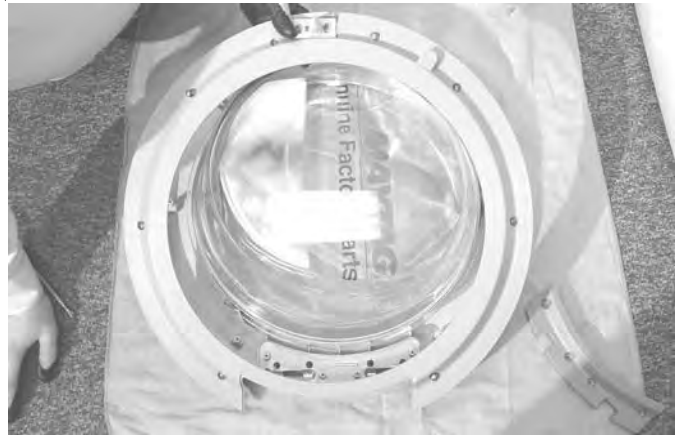

7. Remove glass.



8. Remove external viewing window.



Disassembly Procedures



WARNING

To avoid risk of electrical shock, personal injury or death; disconnect power to unit before servicing.

Front Panel Removal

1. Disconnect power supply to unit.
2. Remove Top Cover.
3. Remove Console.
4. Open door and remove Boot Retainer Clamp. Expand the Boot Clamp Spring located at the 6 o'clock position.



5. Pull the boot from the lip formed into the front opening.

6. Remove four screws attaching the front to the cabinet.



7. Disconnect the wire connectors to the Door Lock.



Disassembly Procedures

WARNING

To avoid risk of electrical shock, personal injury or death; disconnect power to unit before servicing.

8. Lift Front Panel from bottom brackets.



NOTE: When installing the boot align the index tabs on the boot with the screws on either side of the Fill Tube.

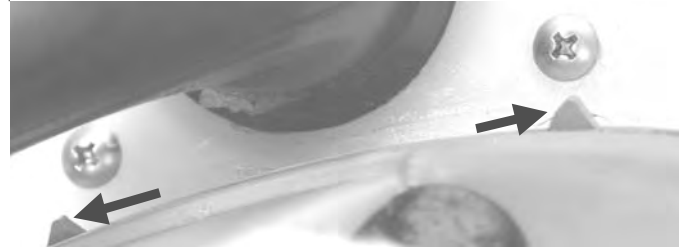

Boot Removal

1. Disconnect power supply to unit.
2. Remove Top Cover (See "Top Cover Removal").
3. Remove Console (See "Console Removal").
4. Remove Front Panel (See "Front Panel Removal").
5. Loosen boot clamp at the 12 o'clock position.

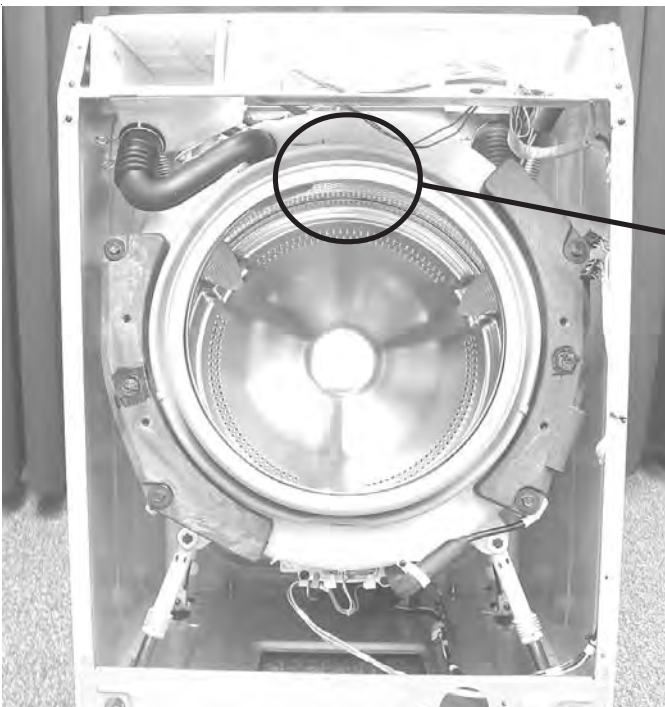

Disassembly Procedures



WARNING

To avoid risk of electrical shock, personal injury or death; disconnect power to unit before servicing.

Motor Removal

1. Disconnect power supply to unit.
2. Remove two screws attaching Back Cover and slide cover up and lift bottom edge out of retaining slots.

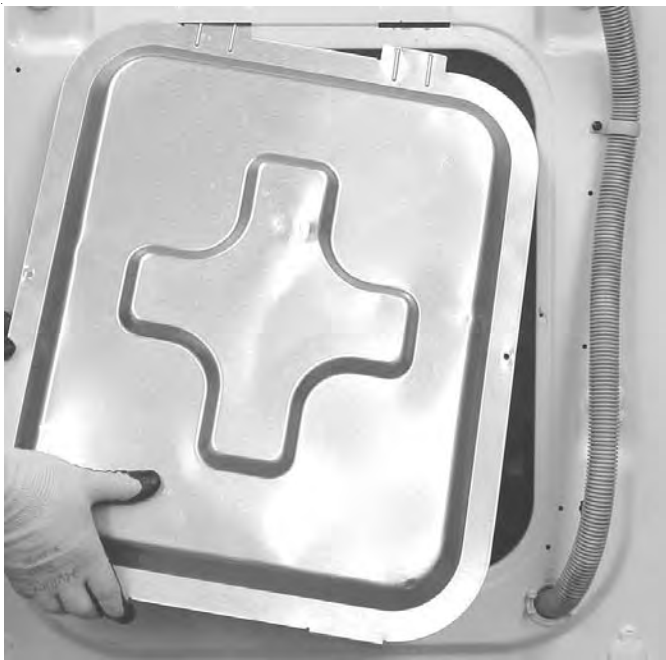

3. Remove Drive Belt.



4. Remove wire harness plug to motor and ground wire.



Disassembly Procedures



WARNING

To avoid risk of electrical shock, personal injury or death; disconnect power to unit before servicing.

5. Remove two 13mm bolts.

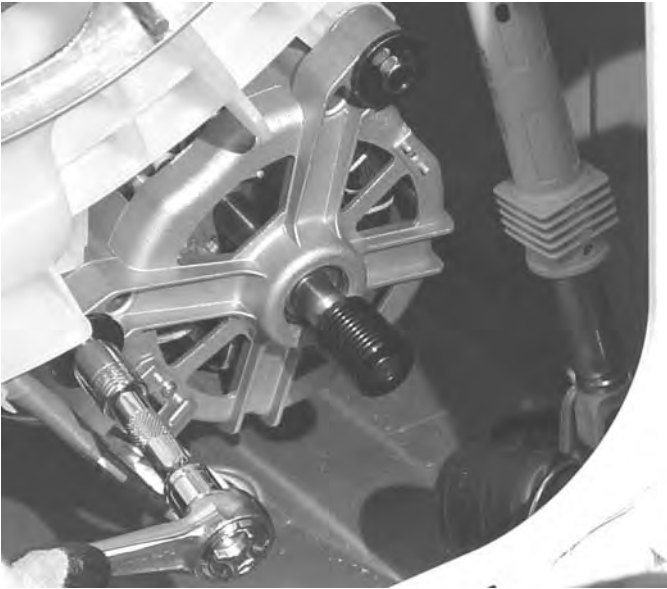

NOTE: During reinstallation be sure all four bushings are installed properly

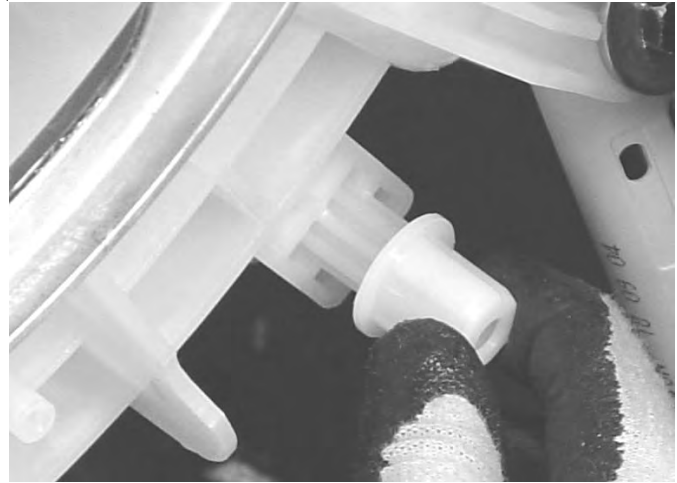

6. Remove Motor from Cabinet.

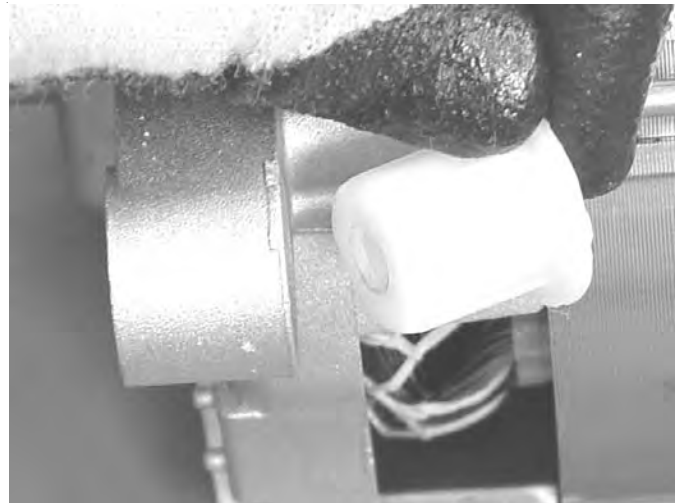

Disassembly Procedures



WARNING

To avoid risk of electrical shock, personal injury or death; disconnect power to unit before servicing.

Drain Pump Removal

1. Disconnect power supply to unit.
2. Remove Back Cover.
3. Remove clamp and Drain Hose.

NOTE: There may be water remaining in the hose from the last cycle.



4. Remove clamp and Pump Hose.



5. Remove wiring connector.



6. Remove three 13mm bolts securing Drain Pump to base.

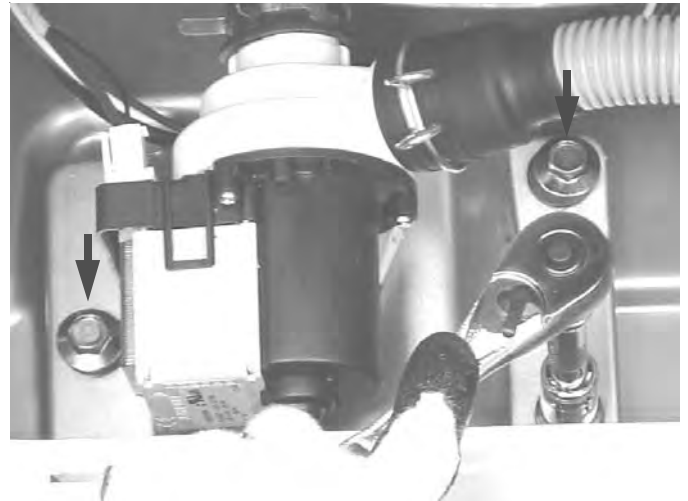

7. Remove screw securing Drain Pump to bracket. Twist Drain Pump clockwise to remove.



Disassembly Procedures

WARNING

To avoid risk of electrical shock, personal injury or death; disconnect power to unit before servicing.

Outer Tub and Spinner Removal

1. Disconnect power supply to unit.
2. Remove Top Cover (See "Top Cover Removal").
3. Remove Console (See "Console Removal").
4. Remove Front Panel (See "Front Panel Removal").
5. Remove Motor (See "Motor Removal").
6. Remove Pump Hose (See "Drain Pump Removal").
7. Remove the Drain Hose (See "Drain Pump Removal").
8. Remove the two 13mm bolts securing the Rear Struts to the base.

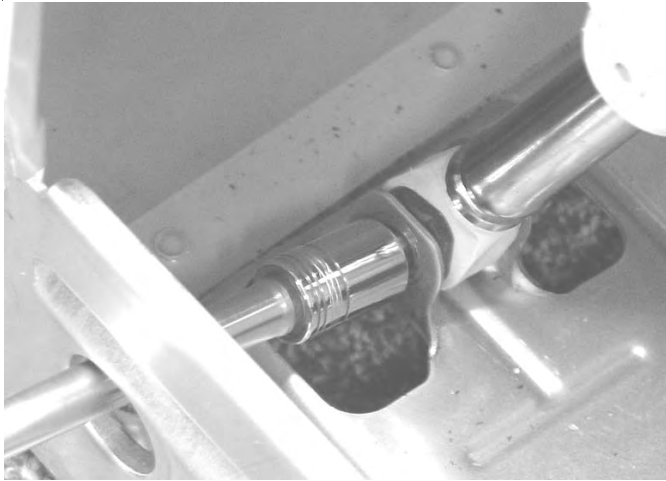

9. Rotate the struts up against the bottom of the tub to ease removal of the tub assembly.



NOTE: The rear struts can be identified by the green sleeve.

10. Remove two each side 13mm bolts securing Counter Weights.

NOTE: Torque bolts to 11-22 ft lbs. during installation.



11. Remove wire harness connectors for the heater, Themistor and ground.
12. Remove two 13mm bolts securing the Front Struts to base and rotate up against the bottom of the tub.
13. Insert a board or boards across the bottom of the washer frame to use as a support when removing the tub assembly.

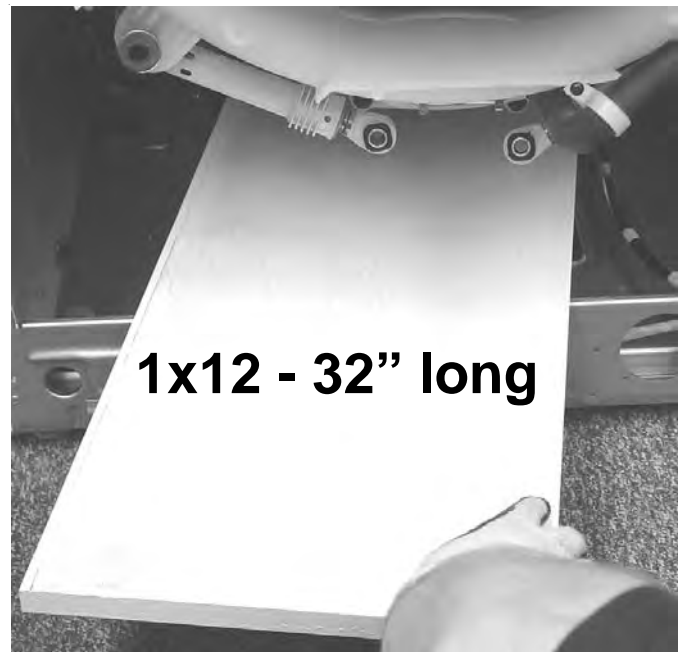

Disassembly Procedures

 **WARNING**

To avoid risk of electrical shock, personal injury or death; disconnect power to unit before servicing.



14. Remove fill hose.

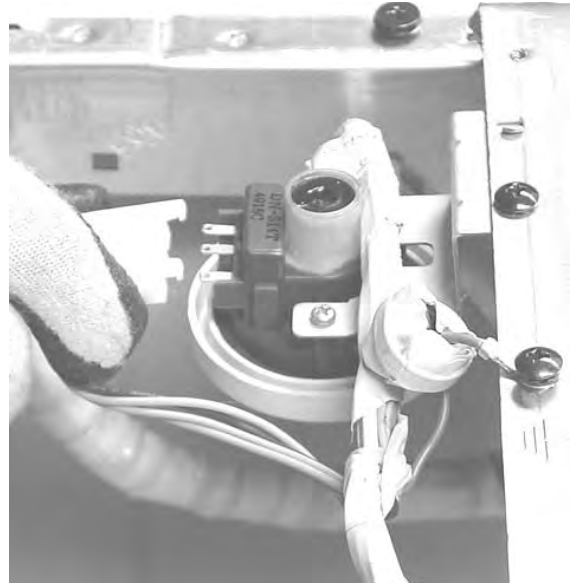

16. Remove the Pressure Hose.



15. Remove Pressure Switch harness connector.



17. Remove ground wire.



Disassembly Procedures



To avoid risk of electrical shock, personal injury or death; disconnect power to unit before servicing.

18. Remove left and right Vent Hoses.



19. Lift Suspension Spring from keeper in cabinet. Repeat for the opposite side and let Outer Tub rest on support board.



20. Remove two screws securing Center Brace to Back Guard.

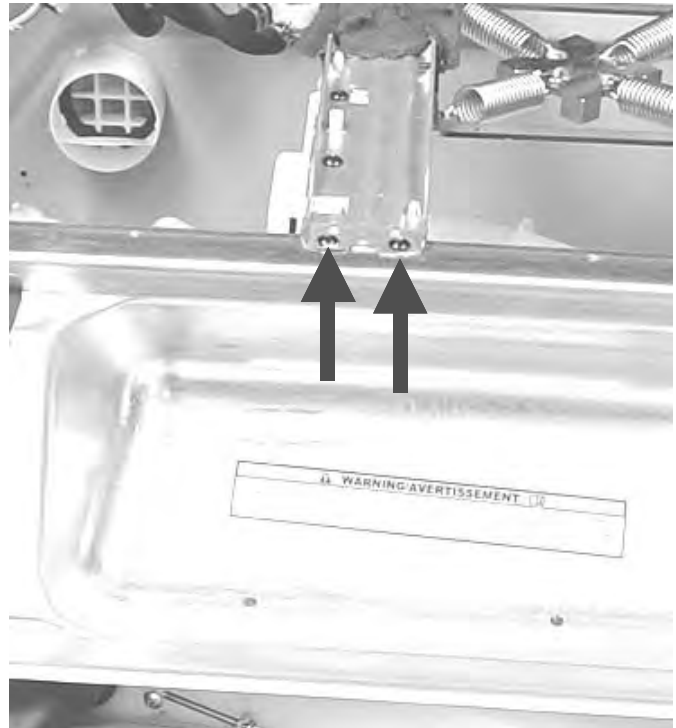

21. Remove remaining screws securing Back Guard to cabinet.



Disassembly Procedures



WARNING

To avoid risk of electrical shock, personal injury or death; disconnect power to unit before servicing.

22. Grasp the front and rear of the tub and slide out. Use a blanket or rug to protect the floor.

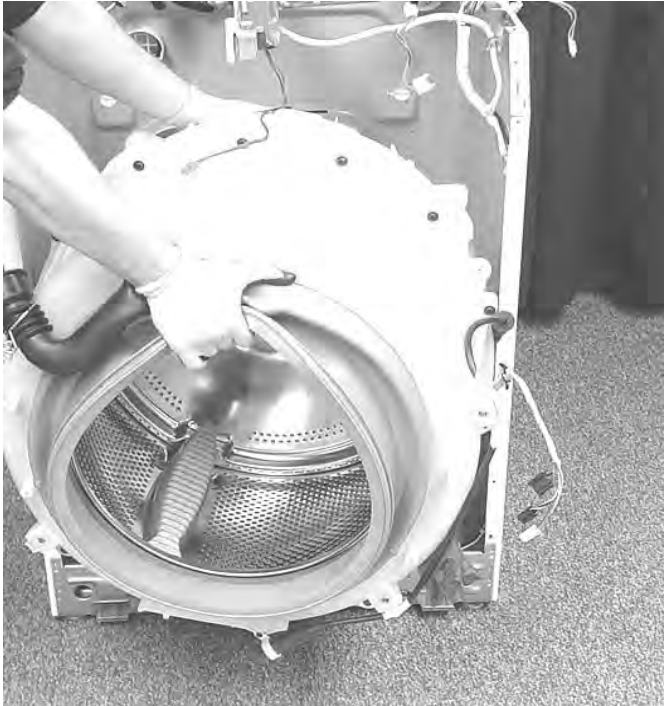

23. Set the tub on the floor. Position 4" wood blocks or equivalent around the spinner shaft. Roll the tub to the upright position and rest it on the blocks.

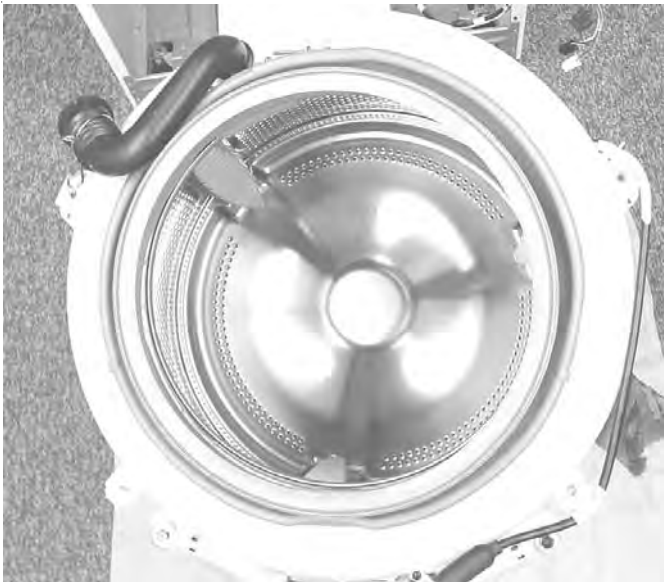

24. Remove the 10mm screws around the perimeter of the tub.

NOTE: Torque tub bolts to 6-11 ft. lbs.



25. Separate the front and rear halves of the Outer Tub.



Disassembly Procedures

⚠ WARNING

To avoid risk of electrical shock, personal injury or death; disconnect power to unit before servicing.

26. Tub Gasket can be replaced after tub halves are split.

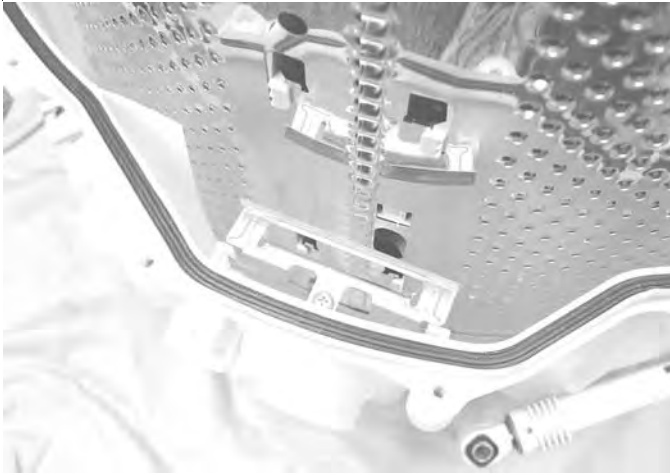

28. Remove screw and release tab to remove Baffles.

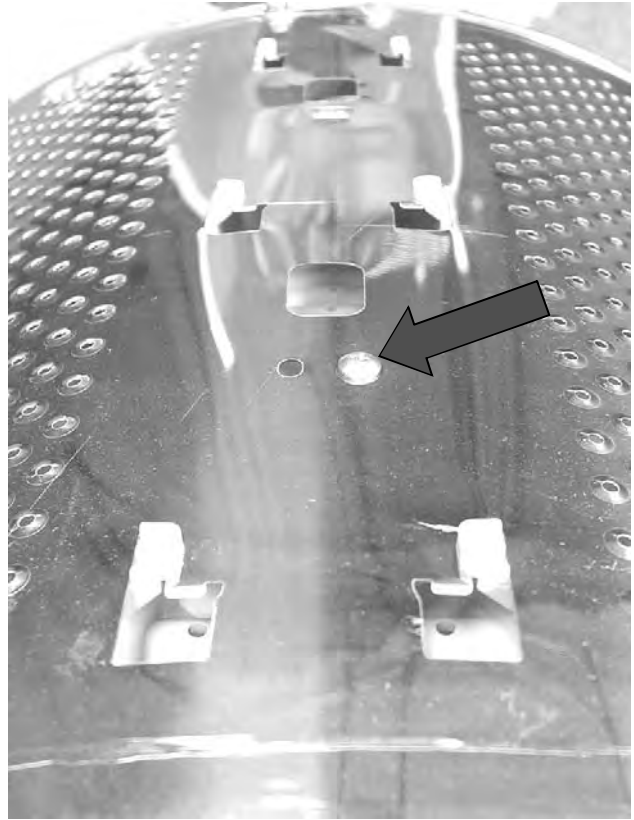

27. Lift Spinner to access Wave Washer.

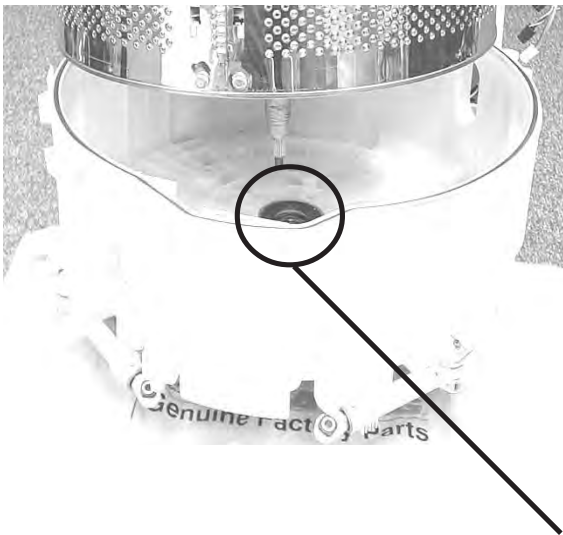

Appendix A



HIGH-EFFICIENCY WASHER INSTALLATION INSTRUCTIONS

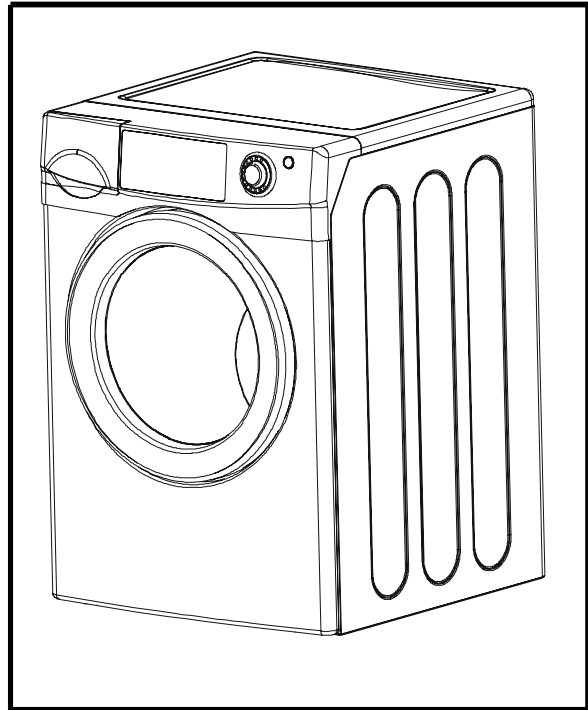
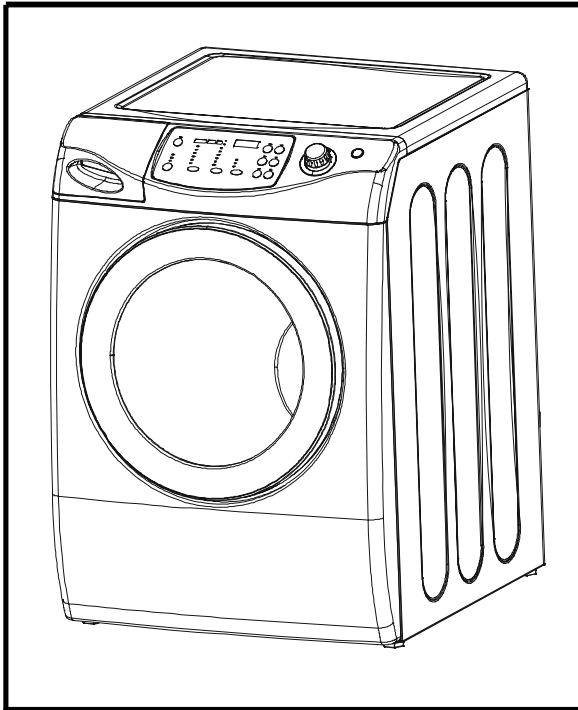

READ THIS BEFORE YOU START...

Tools needed for installation:

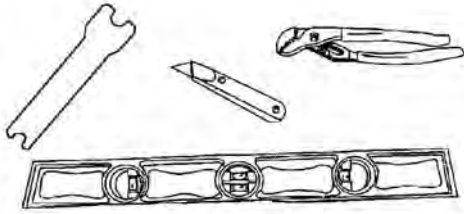

- Multi wrench
- Utility knife
- Channel lock
- Level

PARTS supplied for installation:

Cable tie to secure drain hose to standpipe, inlet hose or laundry tub

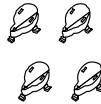

Bolt hole covers

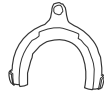

Hose guide

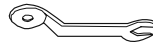

Wrench

ELECTRICAL

Refer to serial plate for specific electrical requirements. For more detailed information refer to section on **Electrical Requirements**.

WATER

Washer needs two standard 3/4 inch water supply faucets with a pressure between 20–120 pounds per square inch. For more detailed information refer to section on **Water Requirements**.

CABINET DIMENSIONS

9700/8700 series	INCH(CM)
A. Height-Overall	38" (96.5)
B. Width	27" (68.6)
C. Depth-With Washer Door Open 90 Degrees	50-7/8" (129.2)
D. Depth	30-3/4" (78.1)

6700 series	INCH(CM)
A. Height-Overall	38" (96.5)
B. Width	27" (68.6)
C. Depth-With Washer Door Open 90 Degrees	49" (124.5)
D. Depth	28" (71.0)

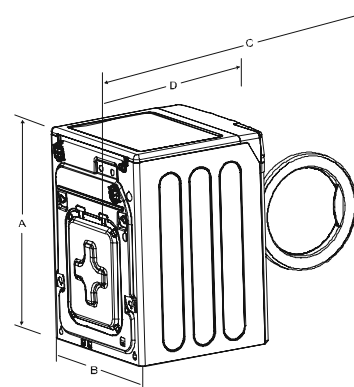
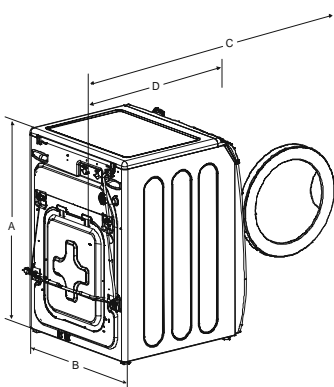

Note:

The height of the washer from top to floor is 38" this includes the leveling leg screwed all the way in. The customer can unscrew the leg out an additional 7/8" for a total overall height of 38 7/8".

BASIC LOCATION REQUIREMENTS:

ELECTRICAL

- 120 Volt 60 Hz 15 AMP Fuse or Circuit Breaker
- Individual branch circuit serving only the washer is recommended.
- The washer is equipped with a power cord.
NEVER USE AN EXTENSION CORD.

GROUNDING

ELECTRICAL GROUND IS REQUIRED ON THIS APPLIANCE.

This appliance must be grounded. In the event of malfunction or breakdown, grounding will reduce the risk of electric shock by providing a path of least resistance for electric current. This appliance is equipped with a power cord having a 3-prong grounding plug for use in a properly installed and grounded outlet.



- Improper connection of the equipment-grounding conductor can result in a risk of electrical shock. Check with a qualified electrician or serviceman if you are in doubt as to whether the appliance is properly grounded. Do not modify the plug provided with the appliance – if it will not fit the outlet, have a proper outlet installed by a qualified electrician.

IMPORTANT SAFETY PRECAUTIONS

- To prevent unnecessary risk of fire, electrical shock or personal injury, all wiring and grounding must be done in accordance with the National Electrical Code ANSI/FNPA, No. 70-Latest Revision and local codes and ordinances. It is the personal responsibility and obligation of the appliance owner to provide adequate electrical service for this appliance.

ADDITIONAL GROUNDING CONNECTIONS

A grounding kit (Part No. 12001875) is available. It contains the ground wire, clamp, ground screw and washer. Connect the ground wire to back of unit with the cabinet ground screw and washer. Secure the other end of ground wire to a grounded COLD metal water pipe.

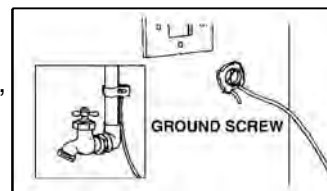

NEVER CONNECT GROUND WIRE TO PLASTIC PLUMBING LINES, GAS LINES OR HOT WATER PIPES.

WATER

To correctly fill the washer in the proper amount of time, Water pressure of 20 to 120 p.s.i. is required. Water pressure less than 20 psi may cause a failure in the water valve and may not allow the water valve to shut off completely. Or may extend the fill time beyond what the washer controls will normally allow and result in the washer turning off. A time limit is built into the controls in the event of an internal hose becoming loose and avoids a flooded home.

The water valve Hot and Cold water faucets must be within 4 feet of the back of the washer for inlet hoses provided with the washer. NOTE: Accessory inlet hoses are available in various lengths up to 10 feet for faucets more than 4 feet from the back of the washer.

To Avoid The Possibility Of Water Damage:

- Have Water Faucets Easily Accessible
- Turn Off Faucets When Washer Is Not In Use.

DRAIN FACILITY

Recommended height of the standpipe is 18". The drain hose must be routed through the drain hose clip to the standpipe. Standpipe must be large enough to accept the outside diameter of the drain hose. The drain hose is attached at the factory.

FLOORING

For best performance the washer must be installed on a solidly constructed floor. Wood floors may need to be reinforced to minimize vibration and/or unbalanced load situations. Carpeting and soft tile surfaces are contributing factors in vibration and/or tendency for a washer to move slightly during the spin cycle. Never install the washer on a platform or weakly supported structure.

LOCATION CONSIDERATIONS

It is recommended the washer never be installed in areas where water may freeze since the washer will always maintain some water in the water valve, pump and hose areas. This can cause damage to belts, pump, hoses and other components. Operating temperature should be above 60°F.

ALCOVE OR CLOSET INSTALLATION

MINIMUM CLEARANCES FOR CLOSET AND ALCOVE INSTALLATIONS:

Sides – 0 in / 0 mm

Rear – 2-3/8 in / 60 mm

Top – 17 in / 432 mm

Closet Front – 2 in / 51 mm

The closet front must have a total unobstructed air opening of 72 in² / 465 cm² minimum, if both washer and dryer are installed together. A louvered door with equivalent air opening is acceptable. Washer alone does not require specific air opening.

ADDITIONAL INFORMATION

50-HERTZ OPERATION

This Maytag appliance is manufactured for operation on 60 Hz AC approved electrical service. This model is not designed for use on 50 Hz AC electrical services and conversion of the product from 60 to 50 Hz operations is not recommended. For additional information on 50 Hz products, write:

MAYTAG INTERNATIONAL, INC.
1475 East Woodfield Road
Schaumburg, Illinois 60173
Phone: 847-273-3100

FOR TECHNICAL ASSISTANCE, REPLACEMENT PARTS AND ACCESSORIES

For technical assistance or if your washer requires replacement parts or accessories, contact **Maytag Customer Service, toll-free 1-888-4-Maytag** for information on the nearest authorized Maytag Parts Distributor.

Proper installation is the responsibility of the owner; **Service Calls Performed As A Result Of Improper Set-up, Adjustment And/Or Connection Are The Responsibility Of The Installer.**

UNPACKING THE WASHING MACHINE

Unpack your washing machine and inspect it for shipping damage and have you have received all of the items shown on page 2. If the washing machine was damaged during shipping or you do not have all of the items, contact your Maytag dealer immediately.

IMPORTANT TO INSTALLER

Please Read The Following Instructions Carefully Before Installing The Washing Machine.

These Instructions Should Be Retained For Future Reference.

Remove The Door From All Discarded Appliances To Avoid The Danger Of A Child Suffocating.

STEP 1

PREPARE WASHER

Removing The Shipping Bolts

Before using the washing machine, you must remove the four shipping bolts from the back of the unit.

1. Loosen all bolts with the supplied wrench before removing them.
2. Slide the bolt and spacer up and remove the bolt with spacer through the hole in the rear wall of the washer. Repeat for each bolt.
3. Fill the holes with the supplied plastic covers.
4. Keep the shipping bolts and spacers for future use.

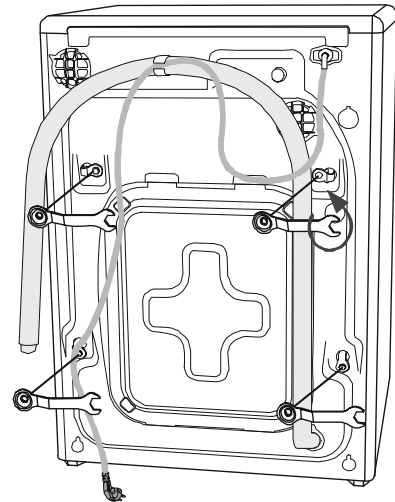

STEP 2

INSTALLING THE WASHING MACHINE

Selecting a location

Before you install the washing machine, select a location with the following characteristics:

- A hard, level surface (if the surface is uneven, see “Adjusting the leveling feet,” below)
- Locate away from direct sunlight.
- Adequate ventilation
- Room temperature that will not fall below 32°F or 0°C.
- Away from sources of heat such as coal or gas
- Make sure that the washing machine does not stand on its power cord.
- Carpeting must not obstruct ventilation openings when the washing machine is installed on a carpeted floor.

STEP 3

INSTALL THE WASHER

1. Place the drain hose in the drain facility. Be sure an airtight connection is **NOT** made between the drain hose and the standpipe. Standpipe must be at least 18" high.

NOTE: If drain standpipe is in excess of 5 feet above floor level, a drain hose extension kit (Part #12002482) will need to be installed. If drain standpipe is in excess of 10 feet above floor level, a pump accessory kit (Part #12001674) may need to be installed.

NOTE: Caution must always be exercised to avoid collapsing or damaging the drain hose. For best performance the drain hose should not be restricted in any way, through elbows, couplings or excessive lengths.

For installations where the drain hose cannot be conveniently elevated to at least 18", the drain hose must be supported.

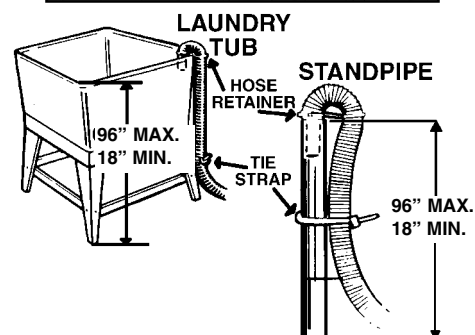
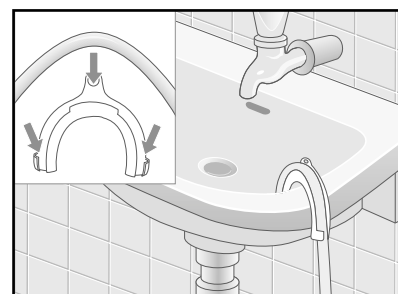

2. Check the inlet hose to ensure a washer is inside of each fill hose. Thread the inlet hoses to the HOT and COLD faucet connections. On the other end of the hose, check for one rubber washer per hose and install each fill hose to the water valve. Make sure the hose marked "HOT" is attached to the HOT faucet. Tighten by hand until snug and the 2/3 of a turn with pliers. **DO NOT OVERTIGHTEN.**

NOTE: For the right use of water, connect both HOT and COLD water valve. If one is not connected, "nF"(No fill) Error can occur.

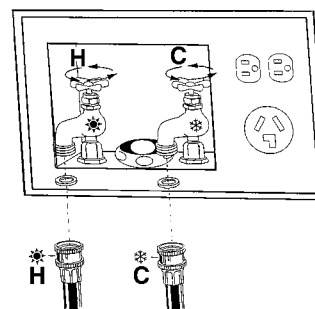

3. Turn on "HOT" and "COLD" water supply and check all connections at the water valve and the faucet for leaks. **NOTE:** Accessory inlet hoses are available in various lengths up to 10 feet.

4. Plug power cord into a grounded 120 volt 60 Hz approved electrical service protected by a 15-amp fuse or comparable circuit breaker. This washer is grounded through the third prong of the power cord when plugged into a three prong grounded receptacle.

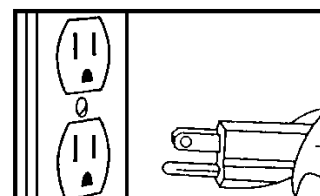

5. Slide washer into position.
6. Level washer by turning the leveling legs in or out as necessary by hand. When the washer is level, tighten the leveling leg lock nuts up against the base of the washer using the wrench supplied with the washer. **NOTE:** The washer must be leveled on all 4 sides. A carpenter's level should be used on all 4 corners of the washer. **It's a good idea after the first dozen washes to recheck the levelness of the washer.**

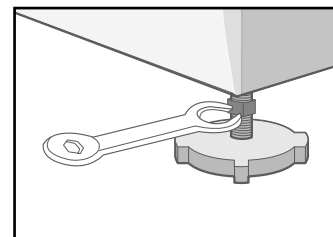

NOTE: Keep the leg extension at a minimum to prevent excessive vibration. The farther out the legs are extended the more the washer will vibrate and possibly walk.

FINAL INSTALLATION CHECKLIST

- Instruction and Installation Kit have been removed from tub.
- Shipping bolts and spacers have been removed.
- Washer is plugged into electrical outlet and is properly grounded.
- Water hoses are connected to the faucets with inlet screens and washers.
- Water is turned on and checked for leaks at faucet and water valve connections on back of washer.
- Drain hose is properly located into drain facility and is not collapsed or damaged.
- Washer has been properly leveled. All legs should be firmly on the floor and leveling leg lock nuts tightened up against the bottom of the washer base frame.
- Washer fills properly on all temperature selections.
- Test for proper operation by running the washer through a complete cycle.

COLD WEATHER STORAGE

The following precautions should be taken if a washer is to be stored, after use, where it would be subject to freezing conditions.

1. Turn off the water supply, then remove the inlet hoses from the facets.
2. Place the end of the inlet hoses into a bucket or container. Select a fill cycle and energize the water valve by selecting a warm water setting. A few seconds of fill is sufficient to empty the inlet hoses.
3. Disconnect from electrical supply.
4. Lower the drain hose to floor level and tilt washer backwards to remove water from the drain hose and pump.

STACKING KIT INSTALLATION INSTRUCTIONS (MAH6700 washer & MDE6700 dryer only)

INSTRUCTIONS D'INSTALLATION DES ÉLÉMENTS DE LA TROUSSE DE SUPERPOSITION (laveuse MAH6700 et sècheuse MDE6700 uniquement)

INSTRUCCIONES DE INSTALACION DEL KIT DE APILAMIENTO (sólo lavadora MAH6700 y secadora MDE6700)



WARNING: This kit is not to be used for stacking a gas dryer. Additional gas hook-up components are required.

AVERTISSEMENT: Ce kit ne doit pas être utilisé pour une superposition du sècheuse de gaz. Des éléments de connexion supplémentaires sont nécessaires.

ADVERTENCIA: Este kit no se usa para el apilamiento de una secadora de gas. Se necesitan componentes de conexión de gas adicionales.

Dryer/Sècheuse/Secadora

Step 1: Place cover (cloth, cardboard, or carpeting) on floor surface to avoid damage.

Étape 1: Placer une protection (tissu, carton ou morceau de moquette) sur le sol pour éviter tout dommage.

Paso 1: Cubra la superficie del piso (tela, cartón o alfombra) para evitar daños.

Step 2: Lay the dryer on its side (not front or back).

Étape 2: Basculer la sècheuse sur le côté (pas sur la partie avant ou arrière).

Paso 2: Coloque la secadora de lado (no sobre el frente ni la parte posterior).



Caution: Two people are required to lift the dryer on to the washer.

Attention: Le sècheuse doit être placé sur le laveuse par deux personnes.

Precaución: Se necesitan dos personas para levantar la secadora y colocarla sobre la lavadora.

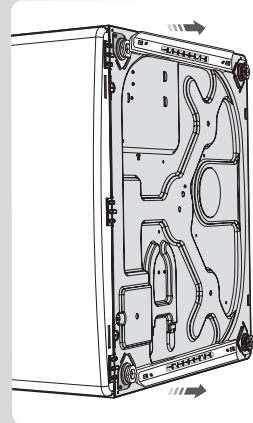

Step 7: Bottom view of the dryer after assembling the stacking kit supports to the dryer base.

Étape 7: Vue de dessous de la sècheuse une fois les supports de fixation montés sur la base de la sècheuse.

Paso 7: Vista inferior de la secadora después de colocar los soportes del kit de apilamiento en la base de la secadora.

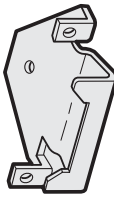

Dryer Rear Bracket
Support arrière de fixation pour la sècheuse
Ménsula trasera de la secadora

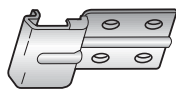

Washer Rear Bracket
Support arrière de fixation pour la laveuse
Ménsula trasera de la lavadora

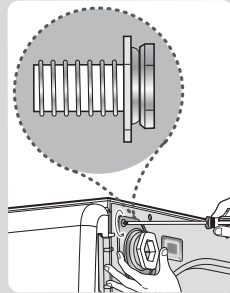

Step 3: Unscrew and disassemble the four leg assemblies.

Étape 3: Dévisser les quatre pieds et les retirer.

Paso 3: Desatornille y desarme los cuatro montajes de las patas.

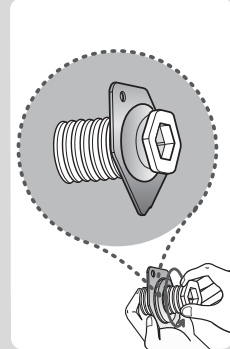

Step 4: Disassemble each leg from the bracket. Then flip the bracket over and remount onto the leg.

Étape 4: Retirer chaque pied de son support. Ensuite, retourner le support et le remonter sur le pied.

Paso 4: Separe cada pata de la ménsula. Luego dá vuelta la ménsula y vuelva a adjuntarla a la pata.

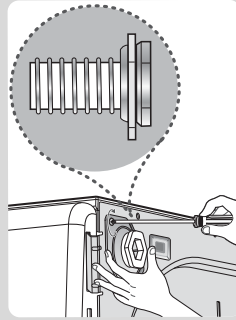

Step 5: Reassemble each leg and bracket into the dryer base.

Étape 5: Remonter les pieds avec leurs supports dans la base de la sècheuse.

Paso 5: Vuelva a colocar cada pata y ménsula en la base de la secadora.

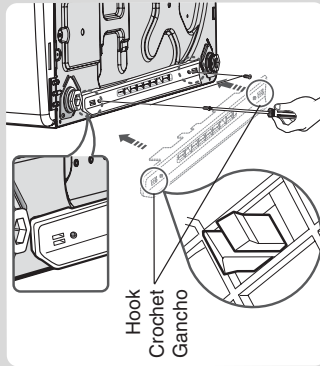

Hook
Crochet
Gancho

Step 6: Snap the stacking supports into the rectangular holes in the dryer base and secure those with two screws.

Étape 6: Enfoncez les supports de superposition dans les orifices rectangulaires de la base du lave-linge et fixez-les à l'aide de deux vis.

Paso 6: Enganche los soportes de apilamiento en los orifices rectangulares en la base de la secadora y asegúrelos con dos tornillos.

Washer/Laveuse/Lavadora

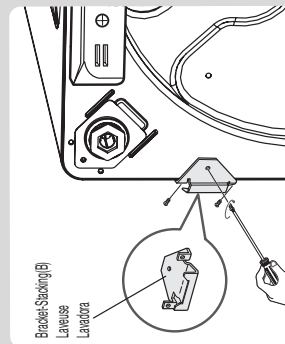

Bracket-Stacking(B)
Laveuse
Lavadora

Step 8: Assemble the dryer brackets to the bottom rear edge of base.

Étape 8: Fixer les supports de fixation sur le bord inférieur arrière de la base de la sècheuse.

Paso 8: Coloque las ménsulas de la secadora en el borde inferior trasero de la base.

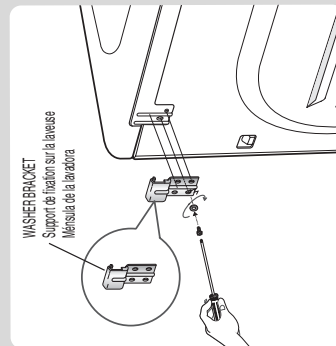

WASHER BRACKET
Support de fixation sur la laveuse
Ménsula de la lavadora

Step 9: Remove one top cover mounting screw, position bracket and secure with washer and same hex-head screw.

Étape 9: Retirez une vis de fixation du plateau supérieur, positionnez le support et fixez-le à l'aide d'une rondelle et de la même vis hexagonale.

Paso 9: Quite un tornillo del montaje de la cubierta superior, coloque la ménsula y asegúrela con la arandela y con el mismo tornillo de cabeza hexagonal.

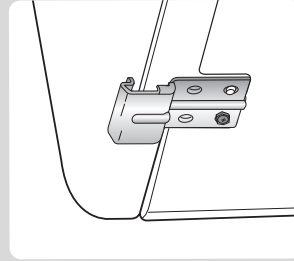

STACKING KIT INSTALLATION INSTRUCTIONS (MAH6700 washer & MDE6700 dryer only)

INSTRUCTIONS D'INSTALLATION DES ÉLÉMENTS DE LA TROUSSE DE SUPERPOSITION (laveuse MAH6700 et sècheuse MDE6700 uniquement)

INSTRUCCIONES DE INSTALACION DEL KIT DE APILAMIENTO (sólo lavadora MAH6700 y secadora MDE6700)

Stack/Superposer/Apilar

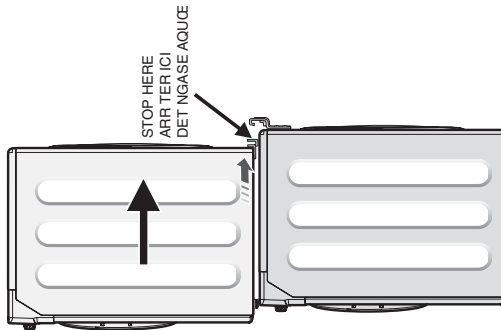

Step 10: Lift and position dryer into the position shown above. Position the unit close to the washer brackets. Doing so will minimize potential scratching of washer top cover.

Étape 10 : Soulever la sècheuse et la placer dans la position illustrée ci-dessus. Placer la sècheuse le plus près possible des supports de fixation de la laveuse. Cela permet de réduire les rayures du recouvrement de la laveuse.

Paso 10: Levante y coloque la secadora en la posición que se muestra arriba. Coloque la unidad cerca de las ménsulas de la lavadora. Hacerlo minimizará los posibles rayones de la cubierta superior de la lavadora.

Prepating: Need to have five(5) inches of clearance behind the dryer and four(4) inches above the dryer when you tip the dryer up to hook the dryer stacking hooks into the washer stacking hooks.

Préparation: Pour enclencher les supports de la sècheuse dans ceux de la laveuse, il faut avoir un espace libre de cinq (5) pouces à l'arrière de la sècheuse et de quatre (4) pouces au-dessus.

Preparación: Debe tener cinco (5) pulgadas de espacio libre detrás de la secadora y cuatro (4) pulgadas sobre la secadora cuando la inclina para trabar los ganchos de apilamiento de la secadora con los ganchos de apilamiento de la lavadora.

STACKING KIT COMPONENTS: ÉLÉMENTS CONTENUS DANS LA TROUSSE DE SUPERPOSITION: COMPONENTES DEL KIT DE APILAMIENTO:

Stacking Support Guides(2)	-34001 449	Screws-Phillips-Pan Head(10)	-6006-001174
Supports de guidage (2)	-34001 449	Vis à tête cylindrique Phillips (10)	-6006-001174
Guides de soporte de apilamiento (2)	-34001 449	Tornillos – Phillips – Cabeza plana (10)	-6006-001174
Dryer Rear Brackets(2)	-34001 450	Vis à tête hexagonale (2)	-34001382
Supports arrière de fixation pour la sècheuse (2)	-34001 450	Tornillos – Cabeza hexagonal (2)	-34001382
Ménsulas traseras de la secadora (2)	-34001 450	Washer(2)	-34001382
Washer Rear Brackets(2)	-34001 451	Rondelle(2)	
Supports arrière de fixation pour la laveuse (2)	-34001 451	Arandelita(2)	
Ménsulas traseras de la lavadora (2)	-34001 451		

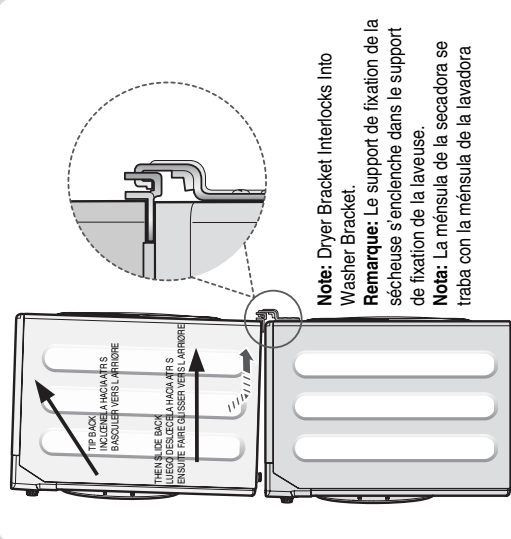

Note: Dryer Bracket Interlocks into Washer Bracket.

Remarque: Le support de fixation de la sècheuse s'enclenche dans le support de fixation de la laveuse.

Nota: La ménsula de la secadora se trabo con la ménsula de la lavadora

Step 11: Tilt the front of the dryer toward the rear and slide the whole dryer back so the dryer brackets interlock into the washer brackets, per drawing above. Once interlocked, gently lower the front of the dryer down onto the washer.

Étape 11: Incliner la sècheuse vers l'arrière et faites-la glisser jusqu'à ce que les supports de la sècheuse s'enclenchent dans ceux de la laveuse, conformément à l'illustration ci-dessus. Une fois que les supports sont enclenchés les uns dans les autres, abaissez la sècheuse sur la laveuse.

Paso 11: Incline la parte delantera de la secadora hacia atrás y deslice la parte posterior de la secadora para que las ménsulas de la secadora se traben con las ménsulas de la lavadora, como lo indica la figura de arriba. Una vez que se trabo, baje suavemente el frente de la secadora sobre la lavadora.

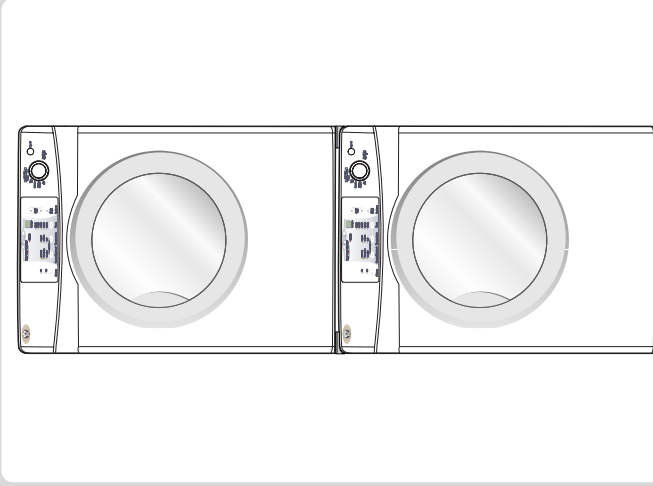

Step 12: Stacked Unit is now ready to be installed. Refer to detailed installation instructions packed with products.

Étape 12: L'unité complète est maintenant prête pour l'installation. Se reporter aux instructions détaillées livrées avec les machines.

Paso 12: La unidad apilada ya está lista para ser instalada. Remítase a las instrucciones de instalación detalladas incluidas con los productos.

NOTES

Appendix B



MAH-3

MAYTAG NEPTUNE[®] WASHER

USE & CARE

G U I D E

TABLE OF CONTENTS

Safety Instructions	1-2
Operating Instructions	3
Using the Controls	4-8
Water Use	8
Detergent Use	9
Features	9-10
Care and Cleaning	11
Storing the Washer	12
Troubleshooting	12-14
Operating Sounds.....	15
Warranty	16

WELCOME

Welcome and congratulations on your purchase of a Maytag Neptune® washer! Your complete satisfaction is very important to us. For best results, we suggest reading this material to help acquaint you with proper operating and maintenance procedures.

Should you need assistance in the future, it is helpful to:

- 1) Have complete model and serial number identification of your washer.

Date of Purchase _____

Model Number _____

Serial Number _____

- 2) **IMPORTANT: Keep this guide and the sales receipt in a safe place for future reference. Proof of original purchase date is needed for warranty service.**

If you have questions, call:

Customer Assistance
1-800-688-9900 USA
1-800-688-2002 CANADA
(Mon.–Fri., 8am–8pm Eastern Time)
Internet: <http://www.maytag.com>

U.S.A. customers using TTY for deaf, hearing impaired or speech impaired, call 1-800-688-2080.

NOTE: In our continuing effort to improve the quality of our appliances, it may be necessary to make changes to the appliance without revising this guide.

For service and warranty information, see page 16.

IMPORTANT SAFETY INSTRUCTIONS

read before operating your washer

WHAT YOU NEED TO KNOW ABOUT SAFETY INSTRUCTIONS

Warning and Important Safety Instructions appearing in this manual are not meant to cover all possible conditions and situations that may occur. Common sense, caution, and care must be exercised when installing, maintaining or operating appliance.

Always contact your manufacturer about problems or conditions you do not understand.

RECOGNIZE SAFETY SYMBOLS , WORDS , LABELS



WARNING – Hazards or unsafe practices which COULD result in severe personal injury or death.



CAUTION – Hazards or unsafe practices which COULD result in minor personal injury or property damage.

SAVE THESE INSTRUCTIONS

IMPORTANT SAFETY INSTRUCTIONS

WARNING

To reduce the risk of fire, electric shock or injury to persons when using the appliance, follow basic precautions, including the following:

1. Read all instructions before using the appliance.
2. As with any equipment using electricity and having moving parts, there are potential hazards. To use this appliance safely, the operator should become familiar with the instructions for operation of the appliance and always exercise care when using it.
3. Do not install or store this appliance where it will be exposed to the weather.
4. Install and level the clothes washer on a floor that can support the weight.
5. This appliance must be properly grounded. Never plug the appliance cord into a receptacle which is not grounded adequately and in accordance with local and national codes. See installation instructions for grounding this appliance.
6. To avoid the possibility of fire or explosion:
 - Do not wash items that have been previously cleaned in, washed in, soaked in, or spotted with gasoline, dry-cleaning solvents, or other flammable or explosive substances as they give off vapors that could ignite or explode. Hand wash and line dry any items containing these substances.

Any material on which you have used a cleaning solvent, or which is saturated with flammable liquids or solids, should not be placed in the clothes washer until all traces of these liquids or solids and their fumes have been removed.

These items include acetone, denatured alcohol, gasoline, kerosene, some liquid household cleaners, some spot removers, turpentine, waxes and wax removers.

- Do not add gasoline, dry-cleaning solvents, or other flammable or explosive substances to the wash water. These substances give off vapors that could ignite or explode.
- Under certain conditions, hydrogen gas may be produced in a hot water system that has not been used for 2 weeks or more. **HYDROGEN GAS IS EXPLOSIVE.** If the hot water system has not been used for such a period, before using a washing machine or combination washer-dryer, turn on all hot water faucets and let the water flow from each for several minutes. This will release any accumulated hydrogen gas. As the

gas is flammable, do not smoke or use an open flame during this time.

7. Unplug power supply cord before attempting to service your clothes washer.
8. Do not reach into the appliance if the tumbler is moving.
9. Do not allow children to play on or in the appliance. Close supervision of children is necessary when the appliance is used near children.
10. Do not tamper with controls.
11. Do not repair or replace any part of the appliance or attempt any servicing unless specifically recommended in published user-repair instructions that you understand and have the skills to carry out.
12. Store laundry aids and other material in a cool, dry place where children cannot reach them.
13. Do not wash or dry items that are soiled with vegetable or cooking oil. These items may contain some oil after laundering. Due to the remaining oil, the fabric may smoke or catch fire by itself.
14. Do not use chlorine bleach and ammonia or acids (such as vinegar or rust remover) in the same wash. Hazardous fumes can form.
15. Do not machine wash fiberglass materials. Small particles can stick to fabrics washed in following loads and cause skin irritation.
16. Before the appliance is removed from service or discarded, remove the door to the washing compartment.
17. Do not sit on top of the clothes washer.
18. Inlet hoses are subject to damage and deterioration over time. Check the hoses periodically for bulges, kinks, cuts, wear or leaks and replace them every five years.

OPERATING INSTRUCTIONS

LOAD THE CLOTHES WASHER

- The tub can be loaded completely full with dry, unfolded clothes. However, **DO NOT** pack the tub tightly.
- Overloading may reduce washing efficiency, cause excess wear and possibly cause creasing or wrinkling of the load.
- Wash delicate items such as bras, hosiery and other lingerie in the Delicates or Hand Wash (select models) cycle with similar lightweight items.
- When washing big bulky items or a couple of small items that do not fill the tub completely, such as a rug, a few towels should be added for improved tumbling and spin performance.
- When washing smaller, bulky items that do not fill the tub completely such as a rug, one pillow, stuffed toys or one or two sweaters, a few towels should be added for improved tumbling and spin performance.
- When washing heavily soiled loads, it is very important to avoid overloading the washer to assure good cleaning results.
- To add a forgotten item in the Super Wash, Normal, Whites (select models), Colors (select models), Wrinkle Control or Quick Wash cycles, press the **Cycle Selector** dial, wait for the Door Lock light to go out (5 seconds), add the item, close the door and press the **Cycle Selector** dial. After a pause of one to two minutes, the cycle will resume.
- Close door carefully to avoid slamming.

NOTE: To ensure that your additional items get clean, do not wait more than five minutes after the cycle has started to add the item.

GETTING STARTED

1. Load the washer loosely – **DO NOT** overload.
2. Close the door.
3. Add detergent and additives to the dispenser (see pages 9-10).
4. Select the appropriate cycle and options for the load, (see pages 4-7).
5. Press the **Cycle Selector** dial.
6. The Wash Indicator light will illuminate.
7. The estimated cycle time will appear in the display. The time may fluctuate to better indicate the wash time remaining in the cycle.
8. Before the washer starts to fill, it will make a series of clicking noises to check the door lock and do a quick drain.

NOTES:

- When the cycle is complete, the Door Lock light will go out and “End” or “00” (select models) will appear in the display.
- **DO NOT** attempt to open the door until the Door Lock light is off. To add a forgotten item, see “Load the Clothes Washer” section.
- When the washer is restarted after a pause, there will be a delay of up to 15 seconds before the cycle will continue.
- Pressing **Power Off** cancels the cycle and stops the washer.
- The Wash, Rinse and Spin indicator lights will illuminate during those portions of the cycle.

USING THE CONTROLS

Control features vary by model.

Step 1

SELECT CYCLE

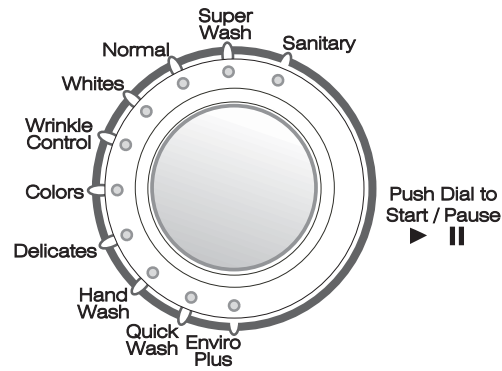

Select the appropriate cycle for the type of load.
This will determine the tumble pattern and spin speed for the cycle.

NOTE: To minimize wrinkling of loads, select the Wrinkle Control cycle.

Sanitary (select models) – For heavily soiled, colorfast garments.
This cycle heats the water to 150°F to eliminate bacteria.

NOTE: If Pause is selected during the heating portion of the Sanitary Cycle, the washer door will remain locked for your safety.

Super Wash – For sturdy, colorfast fabrics and heavily soiled garments.

Normal – For most fabrics including cottons, linens and normally soiled garments.

Whites (select models) – For white fabrics with or without bleach.

Wrinkle Control – For “wash and wear” and synthetic fabrics and lightly to normally soiled garments.

Colors (select models) – For bright fabrics or fabrics that may bleed.

Delicates – For sheer fabrics, bras and lingerie.

Hand Wash – For wool, silk and other hand-wash-only fabrics.
For best results, use liquid detergent.

Quick Wash – For lightly soiled or wrinkled garments needed quickly.

Enviro Plus (select models) – For geographic areas where energy and water conservation is needed.

USING THE CONTROLS

Step 2

SELECT WASH/RINSE WATER TEMPERATURES

Press the arrow pad to select the wash and rinse water temperatures. Follow the garment care label and chart below for best results.

Sanitary/Cold (select models) – Heavily soiled, colorfast items. Only available with the Sanitary cycle.

Hot/Cold – Whites and heavily soiled color-fast items.

ATC Warm/Warm – Color-fast items. When warm rinse is selected, only the final rinse will be warm. The other rinses will be cold to conserve energy.

ATC Warm/Cold – Moderately soiled, color-fast items; most wrinkle free items.

ATC Cold/Cold – Brightly colored, lightly soiled items.

Cold/Cold – Brightly colored, very lightly soiled items; washable woolens.

IMPORTANT: The washer features an automatic temperature control (ATC) to provide a warm wash of approximately 105° F, a cold wash of approximately 65° F and a warm rinse of approximately 80° F in the final rinse only on the ATC temperature selections.

REMEMBER: In wash water temperatures below 65° F, detergents do not dissolve well or clean well.

Control features vary by model.

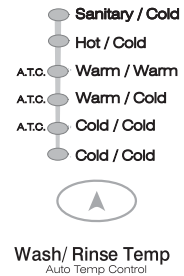

Step 3

SELECT SPIN SPEED

Press the arrow pad to select the spin speed.

Max Extract or Max Extract Plus (select models) – Use for heavy loads such as towels and bedding. Removes more water from loads during spin.

FABRICS NOTE: To minimize wrinkling of wrinkle free and no-iron fabrics, do not use the Max Extract or Max Extract Plus spin option for these loads. Also, DO NOT overload the washer.

High (select models) – Use for underwear, t-shirts, jeans and sturdy cottons.

Medium – Use for jeans, wrinkle free or “wash-and-wear” items and synthetics.

Gentle – Use for items that will be hung up or laid flat to dry.

Low – Use for delicate items needing a slow spin speed because of fabric and construction.

Drain Only (select models) – Drains the washer without spinning. Use for extremely delicate items that cannot tolerate any spin.

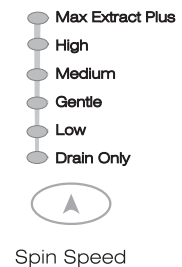

USING THE CONTROLS

Step 4

SELECT SOIL LEVEL

Press the arrow pad to select the Soil Level/washing time.

Heavy – Use for cleaning heavily soiled loads.

Medium – Use for cleaning moderately soiled loads. This setting will be appropriate for most loads.

Light – Use for cleaning lightly soiled loads.

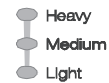

Soil Level

Control features vary by model.

Step 5

SELECT CYCLE OPTIONS

Press the appropriate pad(s) options. The indicator light above the pad will illuminate when the option is selected.

Delay – Any cycle can be delayed for up to 9, 12 or 19 hours (select models *one hour increments*).

1. Make the appropriate selections for your load.
2. Press the **Delay** pad until the desired delay time appears in the display.
3. Press the **Cycle Selector** dial. The delay time will start counting down.
4. To cancel a delay, press the **Power Off** pad and restart.

Chime – Press the **Chime** pad to increase or decrease the end of cycle signal volume or turn the signal off.

Control Lock – The washer controls can be locked to prevent unwanted use by children.

1. Press the **Wash/Rinse Temp** and **Spin Speed** pads at the same time for three seconds.
2. The Control Lock light will illuminate.
3. To unlock, press the **Wash/Rinse Temp** and **Spin Speed** pads at the same time for three seconds. The Control Lock light will go out.



Chime



Wash/ Rinse Temp
Auto Temp Control



Spin Speed



cont.

USING THE CONTROLS

Control features vary by model.

SELECT CYCLE OPTIONS, CONT.

Press the appropriate pad(s) to select one or more options. The indicator light above the pad will illuminate when the option is selected.

Prewash (select models) – Can be selected with any cycle. Add detergent to the prewash section of the detergent compartment. Washer fills with cold water and detergent, tumbles for 25 minutes, then drains and advances to the selected cycle.

Stain Treat (select models) – Adds 5 minutes to the wash for better stain removal.

Extra Rinse – Adds an additional rinse at the end of the cycle to more thoroughly remove laundry additives and perfumes.

Extended Spin (select models) – Adds additional time to the spin to remove more water from the load.

Rinse and Spin – Use for loads that need rinsing only or to add rinse-added fabric softener to a load.

Spin Only – Provides a spin to remove more water from the load.



Step 6

START THE WASHER

To start the washer, press the **Cycle Selector** dial. Before the washer starts to fill, it will make a series of clicking noises to check the door lock and do a quick drain.

Changing a Cycle

If an incorrect cycle has been accidentally selected:

1. Press the **Cycle Selector** dial.
2. Turn the **Cycle Selector** dial to the desired cycle.
3. Set the desired options for the cycle.
4. Press the **Cycle Selector** dial. The Wash indicator lights stop flashing and the new cycle starts.

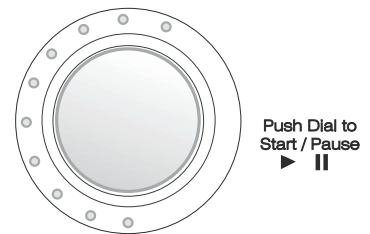

Canceling a Cycle

To cancel a cycle:

1. Press the **Power Off** pad.
2. Select the **Rinse and Spin** or **Spin Only** option pad.
3. Press the **Cycle Selector** dial. The Spin light illuminates and the washer starts the rinse or spin.



USING THE CONTROLS

Control features vary by model.

ESTIMATED TIME DISPLAY (SELECT MODELS)

After setting the cycle and pressing **Cycle Selector** dial, the display will show the estimated minutes remaining in the cycle. The estimated time remaining may fluctuate to better indicate the wash time left in the cycle.



INDICATOR LIGHTS

Door Lock – lights whenever the door of the clothes washer is locked. The door can be unlocked by pressing the **Cycle Selector** dial to pause the washer

Control Lock – The washer controls can be locked to prevent unwanted use by children.

1. Press the **Wash/Rinse Temp** and **Spin Speed** pads at the same time for three seconds.
2. The Control Lock light will illuminate.
3. To unlock, press the **Wash/Rinse Temp** and **Spin Speed** pads at the same time for three seconds. The Control Lock light will go out.



Cycle Indicator Lights – The Wash, Rinse and Spin lights at the top of the control panel will illuminate progressively to indicate when the washer is in those portions of the cycle. These lights will flash when the cycle has been paused.

Pad Indicator Lights – The indicator lights above the pads will illuminate when the pad is selected.

Cycle Setting Indicator Lights – Indicator lights by the cycle settings will illuminate when the selection is made.



WATER USE

INTELLI FILL™ WATER LEVEL CONTROL

The amount of water used will vary with each load. The Maytag Neptune® clothes washer will automatically provide the appropriate amount of water for efficient cleaning performance and conservation of water and energy. Fill time will vary depending on water pressure.

DETERGENT USE

Your Maytag Neptune® washer is designed to use high efficiency (HE) detergents.



- For best cleaning results, use a high efficiency detergent such as Tide HE, Wisk HE, Cheer HE or Gain HE*. High efficiency detergents contain suds suppressors which reduce or eliminate suds. When less suds are produced, the load tumbles more efficiently and cleaning results are maximized.

If HE detergent is not available, regular detergent may be used.

- If using regular detergent formulated for top-loading washers, it is important to pay close attention to the soil level of the load, load size, and water hardness**. **To avoid oversudsing, which interferes with tumbling, rinsing and spinning and causes extended cycle times, reduce the amount of detergent used with soft water or with small or lightly soiled loads.**

NOTE: Reducing the amount of detergent may reduce cleaning. It is important to pretreat stains, sort carefully by color and soil level and avoid overloading.

* Brand names are trademarks of the respective manufacturers.

** To determine water hardness in your area, contact your local water utility or State University Extension office in your area.

FEATURES

AUTOMATIC DISPENSER

The washer has separate compartments for dispensing detergent and color-safe bleach, chlorine bleach and fabric softener. All laundry additives are added to their respective compartments before starting the washer.

The Automatic Dispenser MUST ALWAYS be in place before starting the washer. DO NOT open the Automatic Dispenser when the washer is running.

To use:

1. Pull out the dispenser drawer on the left side of the control panel.
2. Fill appropriate compartments with laundry additives, being careful not to overfill or spill additives.
3. Slide the dispenser drawer carefully and completely back into the compartment.

DETERGENT COMPARTMENT

1. Pour the recommended amount of laundry detergent directly into the detergent compartment before starting the washer.
2. If color-safe bleach is to be used, it should be added with detergent to the detergent compartment.
 - When adding color-safe bleach with detergent, it is best if both laundry products are in the same form; granular or liquid.

NOTE: If using liquid detergent, lower the Detergent Selector and add the detergent to the Detergent Compartment.

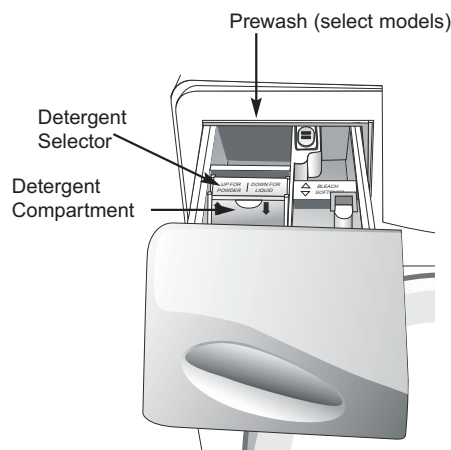

PREWASH COMPARTMENT (SELECT MODELS)

When using the Prewash option (select models), detergent should be added to both the Prewash Compartment and the Detergent Compartment. The detergent will be automatically dispensed during prewash.

- If high efficiency (HE) detergent is used, add 1/3 of the recommended amount to the Prewash Compartment and 2/3 of the recommended amount to the Detergent Compartment.
- If regular detergent is used, add 1/6 of the recommended amount to the Prewash Compartment and 1/3 of the recommended amount to the Detergent Compartment.

FEATURES

BLEACH COMPARTMENT

(Liquid Chlorine Bleach Only)

1. Add chlorine bleach to the Bleach Compartment. **DO NOT** exceed the MAX FILL line.
2. Avoid splashing or over-filling the compartment.
3. The washer automatically dispenses bleach into the tub at the appropriate time.
4. The dispenser automatically dilutes liquid chlorine bleach before it reaches the wash load.

NOTES:

- **Never pour undiluted liquid chlorine bleach directly onto the load or into the tub.** It is a powerful chemical and can cause fabric damage, such as weakening of the fibers or color loss, if not used properly.
- If you prefer to use color-safe, non-chlorine bleach, add it to the appropriate detergent compartment. **DO NOT pour color-safe bleach into the chlorine bleach dispenser.**

FABRIC SOFTENER COMPARTMENT

1. Pour the recommended amount of liquid fabric softener into the softener compartment. For smaller loads, use less than one cap full.
2. Fabric softener should be diluted with warm water until it reaches MAX FILL in the compartment.
3. The dispenser automatically releases liquid fabric softener at the proper time during the rinse cycle.

NOTES:

- Use the softener compartment **ONLY** for liquid fabric softeners.
- **DO NOT** use the Downy Ball with this washer. It will not add fabric softener at the appropriate time. Use the automatic dispenser

* Brand names are trademarks of the respective manufacturers.

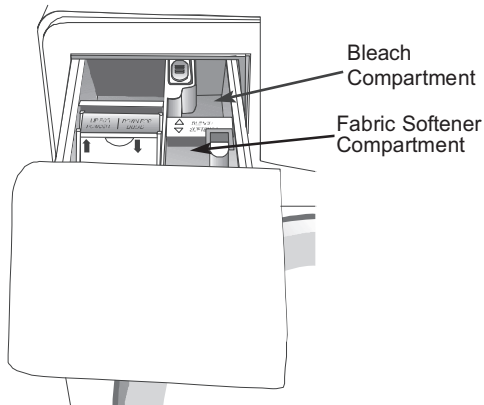

CARE AND CLEANING

Turn off the water faucets after finishing the day's washing. This will shut off the water supply to the clothes washer and prevent the unlikely possibility of damage from escaping water. Leave the door open to allow the inside of the washer to dry out.

Use a soft cloth to wipe up all detergent, bleach or other spills as they occur.

Clean the following as recommended:

Control Panel – Clean with a soft, damp cloth. Do not use abrasive powders or cleaning pads. Do not spray cleaners directly on the panel.

Cabinet – Clean with soap and water

CLEANING THE INTERIOR

Clean the interior of the washer periodically to remove any dirt, soil, odor, mold, mildew or bacteria residue that may remain in the washer as a result of washing clothes. We recommend taking the following steps every 60 to 120 days to clean and freshen your washer interior. The frequency with which the washer should be cleaned and freshened depends on factors such as usage, the amount of dirt, soil or bacteria being run through your washer, or the use of cold water. Failure to follow these instructions may result in unsatisfactory conditions, including unpleasant odor and/or permanent stains on the washer or washload.

To clean and freshen the washer interior:

1. Make a solution of one cup chlorine bleach and two cups warm water. Be careful not to spill or splash the bleach solution.
2. Wipe the door seal with bleach solution and a soft cloth.
3. Fill bleach dispenser with chlorine bleach.
4. Run the washer through a complete cycle using hot water.
5. Repeat the wash cycle if necessary.

Hard water deposits may be removed, if needed. Use a recommended cleaner labeled clothes washer safe.

CLEANING THE DISPENSERS

The Automatic Dispenser may need to be cleaned periodically due to laundry additive buildup.

1. Press the release lever on the inside of the dispenser and pull out.

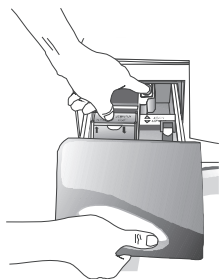

2. Remove the cups from the fabric softener and bleach compartments.
3. Wash all of the parts under running water.
4. Clean the dispenser recess with a soft brush.
5. Reinsert the cups, pushing them firmly into place.
6. Push the dispenser back into place.
7. Run a Rinse & Spin cycle without any load in the washer.

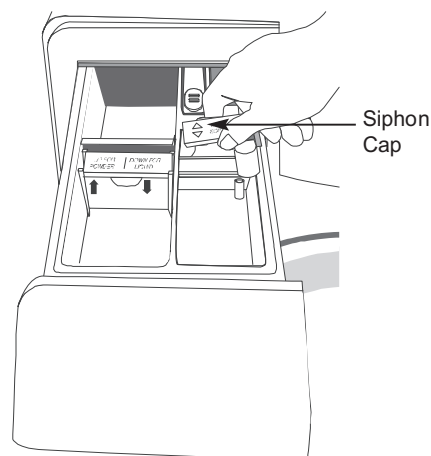

STORING THE CLOTHES WASHER

Washers can be damaged if water is not removed from hoses and internal components before storage. Prepare the washer for storage as follows:

- Select the **Quick Wash** cycle and add bleach to the automatic dispenser. Run the washer through the cycle without a load.
- Turn the water faucets off and disconnect the inlet hoses.
- Disconnect the clothes washer from the electrical supply and leave the washer door open to let air circulate inside the tumbler.
- If the washer has been stored in below-freezing temperatures, allow time for any water left over in the washer to thaw out before use.

For information on long-term storage or storage of your washer during extreme cold temperatures, call Customer Service toll-free at 1-800-688-9900 USA or 1-800-688-2002 Canada. U.S. customers using TTY for deaf, hearing impaired or speech impaired, call 1-800-688-2080.

TROUBLESHOOTING

CHECK THESE POINTS IF YOUR MAYTAG NEPTUNE® WASHER...

Freshening your washer	<ul style="list-style-type: none"> • See Cleaning the Interior, page 11.
The washer will not start	<ul style="list-style-type: none"> • Make sure door is firmly closed. • Make sure the washer is plugged in. • Make sure the water source faucets are turned on. • Make sure to press the Cycle Selector dial to start the washer. • Make sure the Control Lock is not activated, see page 6. • Before the washer starts to fill, it will make a series of clicking noises to check the door lock and do a quick drain.
No water or insufficient water supply	<ul style="list-style-type: none"> • Turn both faucets on fully. • Make sure the door is tightly closed. • Make sure the washer is plugged in. • Check fuse or reset circuit breaker. • Press the Cycle Selector dial to start the washer. • Straighten water inlet hoses. • Disconnect hoses and clean screens. Hose filter screens may be plugged. • Open and close the door, then press the Cycle Selector dial.
Detergent remains in the automatic dispenser after the wash cycle is complete	<ul style="list-style-type: none"> • Make sure the washer is running with sufficient water pressure. See Installation Instructions. • Make sure the Detergent Selector is in the upper position when using granular detergent.
Washer vibrates or is too noisy	<ul style="list-style-type: none"> • Make sure the washer is set on a level surface. If the surface is not level, adjust the washer feet to level the appliance. See Installation Instructions. • Make sure that the shipping bolts are removed. See Installation Instructions. • Make sure the washer is not touching any other object. • Make sure the laundry load is balanced.

CONT.

TROUBLESHOOTING

CHECK THESE POINTS IF YOUR MAYTAG NEPTUNE® WASHER ...

<p>Stops</p>	<ul style="list-style-type: none"> • Plug cord into live electrical outlet. • Check fuse or reset circuit breaker. • Close door and press the Cycle Selector dial to start the washer. For your safety, the washer will not tumble or spin unless the door is closed. • Before the washer starts to fill, it will make a series of clicking noises to check the door lock and do a quick drain. • This may be a pause or soak period in the cycle. Wait briefly and it may start. • Check screens on inlet hoses at the faucets for obstructions. Clean screens periodically.
<p>Fills with the Wrong Temperature Water</p>	<ul style="list-style-type: none"> • Turn both faucets on fully. • Make sure temperature selection is correct. • Make sure hoses are connected to correct faucets. Flush water lines. • Check the water heater. It should be set to deliver a minimum 120° F (49° C) hot water at the tap. Also check water heater capacity and recovery rate. • Disconnect hoses and clean screens. Hose filter screens may be plugged. • As the washer is filling, the water temperature may change as the automatic temperature control feature checks incoming water temperature. This is normal. • While the washer is filling, you may notice just hot and/or just cold water going through the dispenser when cold or warm wash temperatures are selected. This is a normal function of the automatic temperature control feature as the washer determines the temperature of the water.
<p>Won't tumble</p>	<ul style="list-style-type: none"> • Check fuse or reset circuit breaker. • Close the door and press the Cycle Selector dial. For your safety, the washer will not tumble or spin unless the door is closed.
<p>Door locked shut; will not open</p>	<ul style="list-style-type: none"> • Press the Cycle Selector dial to stop the washer. • The washer door will remain locked during the heating portion of the Sanitary Cycle (select models). • It may take a few moments for the door lock mechanism to disengage.
<p>The washer does not drain and/or spin</p>	<ul style="list-style-type: none"> • Check fuse or reset circuit breaker. • Straighten drain hoses. Eliminate kinked hoses. If there is a drain restriction, call for service. • Close the door and press the Cycle Selector dial. For your safety, the washer will not tumble or spin unless the door is closed.
<p>Load is too wet at end of cycle</p>	<ul style="list-style-type: none"> • Use the High or Max Extract spin speed. • Use high efficiency detergent to reduce over-sudsing. • Load is too small. Very small loads (one or two items) may become unbalanced and not spin out completely.
<p>Leaks Water</p>	<ul style="list-style-type: none"> • Make sure door is firmly closed. • Make sure hose connections are tight. • Make sure end of drain hose is correctly inserted and secured to drain facility. • Avoid overloading. • Use high efficiency detergent to prevent over-sudsing.
<p>Excessive Suds</p>	<ul style="list-style-type: none"> • Use high efficiency detergent to prevent over-sudsing. • Reduce detergent amount for soft water, small or lightly soiled loads.

For further assistance, call Customer Service toll-free at 1-800-688-9900 USA or 1-800-688-2002 Canada. U.S. customers using TTY for deaf, hearing impaired or speech impaired, call 1-800-688-2080.

TROUBLESHOOTING

INFORMATION CODES

Information codes may be displayed to help you better understand what is occurring with the washer

Code Symbol	Meaning	Solution
dc	Unbalanced load prevented the washer from spinning.	Redistribute the load, press the Cycle Selector dial.
dL	Door is unlocked when washer is running.	Press Power Off pad then restart the cycle. If the code reappears, call for service, see below.
dS	Door is open when washer is running.	Close the door tightly and restart the cycle. If the code reappears, call for service, see below.
FL	The washer failed to lock the door.	Close the door tightly and restart the cycle. If the code reappears, call for service, see below.
H-	Water temperature control problem. (Heater Control problem)	Call for service, see below.
LE	The washer has tried to fill but has not reached the proper water level.	Call for service, see below.
LO	The door will not unlock.	Make sure the door is firmly closed. Push the Power Off pad to turn off the washer, and then turn it on using any pad. If the code reappears, call for service, see below.
E3	Motor not running properly	Restart the cycle pressing the Cycle Selector dial. If the code reappears, call for service, see below.
nd	The washer is not draining.	See Troubleshooting "The washer does not drain and/or spin", page 13. If problem continues, call for service, see below.
nF	The washer has tried to fill but was unsuccessful.	Make sure the water faucets are open all the way. Check for kinked hoses. Check inlet screens on fill hoses.
Si-	Problem with control.	Call for service, see below.
PF	Electric service was lost when washer was running.	Restart the cycle by pressing the Cycle Selector dial.

For any codes not listed above, call Customer Service at 1-800-688-9900 USA or 1-800-688-2002 Canada.

OPERATING SOUNDS

<p>High-pitched sound during a spin cycle.</p>	<ul style="list-style-type: none"> • The motor increases speed to spin the tub to remove moisture from the load.
<p>Flushing water sound coming from the dispenser area.</p>	<ul style="list-style-type: none"> • Detergent is dispensed at the start of the cycle. Bleach is dispensed during final minutes of wash. Fabric softener is dispensed during the third rinse while the washer is filling.
<p>Whirring or sloshing sound followed by a pause, repeated throughout the wash cycle.</p>	<ul style="list-style-type: none"> • The tub rotates one direction followed by a pause. The tub reverses direction and pauses. This action continues throughout the cycle.
<p>Washer maintains a slightly reduced spin speed after achieving a higher spin speed.</p>	<ul style="list-style-type: none"> • After reaching the maximum spin speed, the machine may reduce spin speed slightly for maximum performance.
<p>The spin speed slows down dramatically when it sounds like an out-of-balance load.</p>	<ul style="list-style-type: none"> • The tumbler will begin to accelerate to speed, then slows back down to redistribute the load more evenly when an unbalanced load occurs.
<p>Water is added after the washer has been tumbling for a while.</p>	<ul style="list-style-type: none"> • The Maytag Neptune® clothes washer uses a true adaptive fill and adds more water during the wash cycle as it is needed. • Water flows through the dispenser to dilute and add bleach or fabric softener at the appropriate time. This will occur even if bleach and fabric softener are not used.
<p>Clicking/draining sounds when washer is started.</p>	<ul style="list-style-type: none"> • Before the washer starts to fill, it will make a series of clicking noises to check the door lock and do a quick drain.
<p>Washer beeps after cycle has started.</p>	<ul style="list-style-type: none"> • This is audio confirmation the door has locked successfully.
<p>Rhythmic air rushing during spin.</p>	<ul style="list-style-type: none"> • Due to tub movement during the spin cycle, air is transferred in and out of the tub to provide optimum performance.
<p>Rapid snapping and/or popping sound from the rear of the washer during spin.</p>	<ul style="list-style-type: none"> • Water is being extracted through the drain holes in the spinner and is hitting the outer tub before draining out of the machine.

CLOTHES WASHER WARRANTY

Warranty

Limited One Year Warranty - Parts and Labor

For one (1 year) from the original retail purchase date, any part which fails in normal home use will be repaired or replaced free of charge.

Canadian Residents

The above warranties only cover an appliance installed in Canada that has been certified or listed by appropriate test agencies for a compliance to a National Standard of Canada unless the appliance was brought into Canada due to transfer of residence from the United States to Canada.

The specific warranties expressed above are the ONLY warranties provided by the manufacturer. These warranties give you specific legal rights, and you may also have other rights which vary from state to state.

CUSTOMER'S SOLE AND EXCLUSIVE REMEDY UNDER THIS LIMITED WARRANTY SHALL BE PRODUCT REPAIR AS PROVIDED HEREIN. IMPLIED WARRANTIES, INCLUDING WARRANTIES OF MERCHANTABILITY OR FITNESS FOR A PARTICULAR PURPOSE, ARE LIMITED TO ONE YEAR OR THE SHORTEST PERIOD ALLOWED BY LAW. MAYTAG CORPORATION SHALL NOT BE LIABLE FOR INCIDENTAL OR CONSEQUENTIAL DAMAGES. SOME STATES AND PROVINCES DO NOT ALLOW THE EXCLUSION OR LIMITATION OF INCIDENTAL OR CONSEQUENTIAL DAMAGES, OR LIMITATIONS ON THE DURATION OF IMPLIED WARRANTIES OF MERCHANTABILITY OR FITNESS, SO THESE EXCLUSIONS OR LIMITATIONS MAY NOT APPLY TO YOU. THIS WARRANTY GIVES YOU SPECIFIC LEGAL RIGHTS AND YOU MAY ALSO HAVE OTHER RIGHTS, WHICH VARY STATE TO STATE OR PROVINCE TO PROVINCE.

What is Not Covered By These Warranties

1. Conditions and damages resulting from any of the following:
 - a. Improper installation, delivery, or maintenance.
 - b. Any repair, modification, alteration, or adjustment not authorized by the manufacturer or an authorized servicer.
 - c. Misuse, abuse, accidents, unreasonable use, or acts of God.
 - d. Incorrect electric current, voltage, electrical and/or gas supply.
 - e. Improper setting of any control.
 - f. Use of risers (pedestals) that are not Maytag Branded.
2. Warranties are void if the original serial numbers have been removed, altered, or cannot be readily determined.
3. Light bulbs, water filters and air filters.
4. Products purchased for commercial or industrial use.
5. The cost of service or service call to:
 - a. Correct installation errors. For products requiring ventilation, rigid metal ducting must be used.
 - b. Instruct the user on the proper use of the product.
 - c. Transport the appliance to and from the servicer.
 - d. Correct issues related to risers that are not Maytag Branded.
6. Any food loss due to refrigerator or freezer product failures.
7. Expenses for travel and transportation for product service in remote locations.
8. Outside of the United States and Canada this warranty does not apply. Contact your dealer to determine if another warranty applies.
9. Consequential or incidental damages sustained by any person as a result of any breach of these warranties. Some states do not allow the exclusion or limitation of consequential or incidental damages, so the above exclusion may not apply.

If You Need Service

First see the Troubleshooting section in your Use and Care Guide or call the dealer from whom your appliance was purchased or at Maytag Services, LLC, Customer Assistance at 1-800-688-9900 USA and 1-800-688-2002 Canada to locate an authorized servicer.

- Be sure to retain proof of purchase to verify warranty status. Refer to WARRANTY for further information on owner's responsibilities for warranty service.
- If the dealer or service company cannot resolve the problem, write to Maytag Services, LLC, Attn: CAIR® Center, P.O. Box 2370, Cleveland, TN 37320-2370, or call 1-800-688-9900 USA and 1-800-688-2002 Canada. U.S. customers using TTY for deaf, hearing impaired or speech impaired, call 1-800-688-2080.
- User's guides, service manuals and parts information are available from Maytag Services, LLC, Customer Assistance.

Notes: When writing or calling about a service problem, please include:

- a. Your name, address and telephone number;
- b. Model number and serial number;
- c. Name and address of your dealer or servicer;
- d. A clear description of the problem you are having;
- e. Proof of purchase (sales receipt).