

Service

This manual is to be used by qualified appliance technicians only. Maytag does not assume any responsibility for property damage or personal injury for improper service procedures done by an unqualified person.

Bottom Mount Refrigerators



This Base Manual covers general information

Refer to individual Technical Sheet for information on specific models

This manual includes, but is not limited to the following:

Amana

ABB1921DE*
ABB1924DE*
ABB1927DE*
ABB192ZDE*
ABB2224DE*
ABB2227DE*
ABB222ZDE*
ABB2524DE*
ABB2527DE*
ABC2037DPS
ABC2037DT*
ABD2233DE*
ABD2533DE*
ABR2224DE*
ABR2227DE*
ABR222ZDE*
AFD2535DE*

Jenn-Air

JBB2088HE*
JBL2086HE*
JBL2087HE*
JBL2088HE*
JBR2087HE*
JFC2087HE*
JFC2087HP*
JFC2087HR*
JBC2089HE*

Maytag

MBB1952HE*
MBB2224DE*
MBF1956HE*
MBF2256HE*
MBF2258HE*
MBF2259HE*
MBF2262HE*
MBF2556HE*
MBF2558HE*
MBD2560HE*
MFD2560HE*
MBD2561HE*
MBF2562HE*
PBB1951HE*
PBF1951HE*
PBF2253HE*
PBF2255HE*
PBF2555HE*



16025629
Replaces 16022769
February 2005

Important Information

Important Notices for Servicers and Consumers

Maytag will not be responsible for personal injury or property damage from improper service procedures. Pride and workmanship go into every product to provide our customers with quality products. It is possible, however, that during its lifetime a product may require service. Products should be serviced only by a qualified service technician who is familiar with the safety procedures required in the repair and who is equipped with the proper tools, parts, testing instruments and the appropriate service information. **IT IS THE TECHNICIANS RESPONSIBILITY TO REVIEW ALL APPROPRIATE SERVICE INFORMATION BEFORE BEGINNING REPAIRS.**



WARNING

To avoid risk of severe personal injury or death, disconnect power before working/servicing on appliance to avoid electrical shock.

To locate an authorized servicer, please consult your telephone book or the dealer from whom you purchased this product. For further assistance, please contact:

Customer Service Support Center

CAIR Center

Web Site	Telephone Number
WWW.AMANA.COM	1-800-843-0304
WWW.JENNAIR.COM	1-800-536-6247
WWW.MAYTAG.COM	1-800-688-9900
CAIR Center in Canada	1-800-688-2002
Amana Canada Product	1-866-587-2002

Recognize Safety Symbols, Words, and Labels



DANGER

DANGER—Immediate hazards which **WILL** result in severe personal injury or death.



WARNING

WARNING—Hazards or unsafe practices which **COULD** result in severe personal injury or death.



CAUTION

CAUTION—Hazards or unsafe practices which **COULD** result in minor personal injury, product or property damage.

Table of Contents

Important Information	2	Temp- Assure™ Damper control	32
Product Design	4	Electronic Temp-Assure™ Damper control	33
Component Testing	5	Fresh Food Thermistor	33
Service Procedures	11	Water Tank	33
Service Equipment	11	Water Dispenser	33
Drier Replacement	11	Freezer Compartment	
Refrigerant Precautions	12	Freezer Temperature Control	33
Line Piercing Valves	12	Freezer Thermistor	34
Open Lines	12	Light Socket	34
Compressor Operational Test	12	Light Switch	34
Dehydrating Sealed Refrigeration System	13	Freezer Back Panel	34
Leak Testing	13	Evaporator Fan and Evaporator Motor	34
Testing Systems Containing a		Defrost Terminator (thermostat)	34
Refrigerant Charge	13	Defrost Heater	34
Testing Systems Containing		Evaporator Removal	35
No Refrigerant Charge	13	Drawer Assembly	35
Restrictions	14	Drawer Rails	35
Symptoms	14	Rack and Pinion Gear	35
Testing for Restrictions	14	Bottom of Cabinet	
Evacuation and Charging	15	Front roller assembly	35
Evacuation	15	Rear roller assembly.....	36
Charging	16	Machine Compartment	
Refrigerant Charge	16	Condenser Fan and Fan motor	36
HFC134a Service Information	17	Compressor	36
Health, Safety, and Handling	17	Overload/Relay/Capacitor	36
Comparison of CFC12 and HFC134a Properties	17	Condensate Drain Pan	36
Replacement Service Compressor	18	Condensate Drain Tube	36
Compressor Testing Procedures	18	Condenser Removal	36
Brazing	18	Control Board (Mid Level)	
Refrigerant Flow 19, 20, 22, 25 cu. ft	19	Programming Mode	37
Cabinet Air Flow 19, 20, 22, 25 cu. ft	20	Defrost Operation	37
20 cu. ft Machine Compartment Air Flow Diagram	21	Forced Defrost Mode	37
19, 22, 25 cu. ft Machine Compartment		Service Test Mode	38
Air Flow Diagram	22	Service Test 1-Defrost Thermostat & Defrost Circuit	
Water Dispenser Flow	23	Test	38
Typical External Sweat Pattern.....	24	Service Test 2-Compressor/Condenser Fan Test	39
Troubleshooting Chart.....	25	Service Test 3-Evaporator/Freezer Fan Test	39
System Diagnosis	28	Service Test 4-Fresh Food Thermistor Test	39
Disassembly Procedures		Service Test 5-Freezer Thermistor Test	39
Fresh Food Door	31	Service Test 6-Open Damper Test	40
Freezer Door	31	Service Test 7-FF Performance Adjustment	40
Freezer Drawer	31	Service Test 8-FZ Performance Adjustment	40
Refrigerator Compartment		Show Room Mode	41
Light Bulb	31	Thermistor Resistance Chart	41
Light Bulb Assembly	31	Control Board (Fully Electronic)	42
Light Bulb Sockets	32	Programming Mode:	42
Defrost Timer	32	Defrost Operation	42
PC Control Board	32	Forced Defrost Mode	42
Light Switch	32	Service Test Mode	42
		Show Room Mode	45
		Sabbath Mode	45
		Fahrenheit or Celsius Mode	45
		Alarm Enable Mode	45
		Appendix A	
		Owner's Manual	A-1

Product Design



WARNING

To avoid risk of electrical shock, personal injury, or death, disconnect electrical power source to unit, unless test procedures require power to be connected. Discharge capacitor through a resistor before attempting to service. Ensure all ground wires are connected before certifying unit as repaired and/or operational.

Refrigeration System

Compressor forces high temperature vapor into fan cooled tube and wire condenser where vapor is cooled and condensed into high pressure liquid by circulation of air across condenser coil. (See Refrigerant Flow Diagram, page 18)

High pressure liquid passes into post-condenser loop which helps to prevent condensation around freezer compartment opening and through molecular sieve drier and into capillary tube. Small inside diameter of capillary offers resistance, decreasing pressure, and temperature of liquid discharged into evaporator. Capillary diameter and length is carefully sized for each system.

Capillary enters evaporator at top front. Combined liquid and saturated gas flows through front to bottom of coil and into suction line. Aluminium tube evaporator coil is located in freezer compartment where circulating evaporator fan moves air through coil and into fresh food compartment.

Large surface of evaporator allows heat to be absorbed from both fresh food and freezer compartments by airflow over evaporator coil causing some of the liquid to evaporate. Temperature of evaporator tubing near end of running cycle may vary from -13°F to -25°F.

Saturated gas is drawn off through suction line where superheated gas enters compressor. To raise temperature of gas, suction line is placed in heat exchange with capillary.

Temperature Controls

Freezer compartment temperature is regulated by air sensing thermostat at top front of freezer compartment which actuates compressor. Control should be set to maintain freezer temperature between 0°F to -2°F.

Fresh food compartment temperature is regulated by an air damper control governing amount of refrigerated air entering fresh food compartment from freezer. Fresh food compartment temperature should be between 38°F and 40°F.

Defrost System

Mechanical Defrost

Every 8 hours of compressor run time defrost timer activates radiant electric defrost heater suspended from evaporator. After 33 minutes of defrost cycle time, timer restores circuit to compressor.

Defrost terminator (thermostat) is wired in series with defrost heater. Terminator opens and breaks circuit when preset high temperature is reached. After defrost thermostat opens, thermostat remains open until end of defrost cycle when cooling cycle starts and terminator senses present low temperature and closes.

Defrost heater is suspended on left side of evaporator coil and across bottom to keep defrost drain free flowing during defrost. Defrost water is caught in trough under evaporator coil and flows through drain hole in liner and drain tubing into drain pan. Air circulated by condenser fan over pan evaporates water.

Mid Level & Fully Electronic Defrost System

The Control Board adapts the compressor run time between defrosts to achieve optimum defrost intervals by monitoring the length of time the defrost heater is on.

After initial power up, defrost interval is 4 hours compressor run time. Defrost occurs immediately after the 4 hours.

Note: Once unit is ready to defrost there is a 4 minute wait time prior to the beginning of the defrost cycle.

Component Testing



WARNING

To avoid risk of electrical shock, personal injury, or death, disconnect electrical power source to unit, unless test procedures require power to be connected. Discharge capacitor through a resistor before attempting to service. Ensure all ground wires are connected before certifying unit as repaired and/or operational.



Component	Description	Test Procedures
<div data-bbox="186 472 332 640" data-label="Image"> </div> <p data-bbox="162 407 284 434">Compressor</p>	<p data-bbox="349 407 743 625">When compressor electrical circuit is energized, the start winding current causes relay to heat. After an amount of starting time, the start winding circuit turns off. The relay will switch off the start winding circuit even though compressor has not started (for example, when attempting to restart after momentary power interruption).</p> <p data-bbox="349 646 743 766">With “open” relay, compressor will not start because there is little or no current to start windings. Overload protection will open due to high locked rotor run winding current.</p> <p data-bbox="349 787 743 907">With “shorted” relay or capacitor, compressor will start and overload protector will quickly open due to high current of combined run and start windings.</p> <p data-bbox="349 928 743 1005">With open or weak capacitor, compressor will start and run as normal but will consume more energy.</p>	<p data-bbox="748 407 917 434">Resistance test</p> <ol data-bbox="748 434 1523 478" style="list-style-type: none"> 1. Disconnect power to unit. 2. Discharge capacitor by shorting across terminals with a resistor for 1 minute. <p data-bbox="748 478 1291 506">NOTE: (Some compressors do not have a run capacitor.)</p> <ol data-bbox="748 506 1523 674" style="list-style-type: none"> 3. Remove leads from compressor terminals. 4. Set ohmmeter to lowest scale. 5. Check for resistance between <ul data-bbox="844 569 1185 625" style="list-style-type: none"> Terminals “S” and “C”, start winding Terminals “R” and “C”, run winding <p data-bbox="795 625 1523 674">If either compressor winding reads open (infinite or very high resistance) or dead short (0 ohms), replace compressor.</p> <p data-bbox="748 684 868 711">Ground test</p> <ol data-bbox="748 711 1523 856" style="list-style-type: none"> 1. Disconnect power to refrigerator. 2. Discharge capacitor, if present, by shorting terminals through a resistor. 3. Remove compressor leads and use an ohmmeter set on highest scale. 4. Touch one lead to compressor body (clean point of contact) and other probe to each compressor terminal. <ul data-bbox="779 835 1461 856" style="list-style-type: none"> • If reading is obtained, compressor is grounded and must be replaced. <p data-bbox="748 867 901 894">Operation test</p> <p data-bbox="748 894 1523 942">If voltage, capacitor, overload, and motor winding tests do not show cause for failure, perform the following test:</p> <ol data-bbox="748 942 1523 1199" style="list-style-type: none"> 1. Disconnect power to refrigerator. 2. Discharge capacitor by shorting capacitor terminals through a resistor. 3. Remove leads from compressor terminals. 4. Wire a test cord to power switch. 5. Place time delayed fuse with UL rating equal to amp rating of motor in test cord socket. (Refer to Technical Data Sheet) 6. Remove overload and relay. 7. Connect start, common and run leads of test cord on appropriate terminals of compressor. 8. Attach capacitor leads of test cord together. If capacitor is used, attach capacitor lead to a known good capacitor of same capacity. <div data-bbox="971 1213 1302 1558" data-label="Diagram"> <p data-bbox="1047 1558 1226 1585">Test configuration</p> </div> <ol data-bbox="748 1598 1523 1906" style="list-style-type: none"> 9. Plug test cord into multimeter to determine start and run wattage and to check for low voltage, which can also be a source of trouble indications. 10. With power to multimeter, press start cord switch and release. <ul data-bbox="779 1675 1523 1906" style="list-style-type: none"> • If compressor motor starts and draws normal wattage, compressor is okay and trouble is in capacitor, relay/overload, freezer temperature control, or elsewhere in system. • If compressor does not start when direct wired, recover refrigerant at high side. After refrigerant is recovered, repeat compressor direct wire test. If compressor runs after recovery but would not run when direct wired before recover, a restriction in sealed system is indicated. • If compressor does not run when wired direct after recovery, replace faulty compressor.

Component Testing

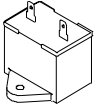

WARNING

To avoid risk of electrical shock, personal injury, or death, disconnect electrical power source to unit, unless test procedures require power to be connected. Discharge capacitor through a resistor before attempting to service. Ensure all ground wires are connected before certifying unit as repaired and/or operational.

Component	Description	Test Procedures
<p>Capacitor</p> 	<p>Run capacitor connects to relay terminal 3 and L side of line.</p> <p>Some compressors do not require a run capacitor; refer to the Technical Data Sheet for the unit being serviced.</p>	<div style="border: 1px solid black; padding: 5px; margin-bottom: 10px;">  <h3 style="margin: 0;">WARNING</h3> <p>To avoid electrical shock which can cause severe personal injury or death, discharge capacitor through a resistor before handling.</p> </div> <ol style="list-style-type: none"> 1. Disconnect power to refrigerator. 2. Remove capacitor cover and disconnect capacitor wires. 3. Discharge capacitor by shorting across terminals with a resistor for 1 minute. 4. Check resistance across capacitor terminals with ohmmeter set on "X1K" scale. <ul style="list-style-type: none"> • Good—needle swings to 0 ohms and slowly moves back to infinity. • Open—needle does not move. Replace capacitor. • Shorted—needle moves to zero and stays. Replace capacitor. • High resistance leak—needle jumps toward 0 and then moves back to constant high resistance (not infinity).
<p>Condenser</p>	<p>Condenser is a tube and wire construction located in machine compartment.</p> <p>Condenser is on high pressure discharge side of compressor. Condenser function is to transfer heat absorbed by refrigerant to ambient.</p> <p>Higher pressure gas is routed to condenser where, as gas temperature is reduced, gas condenses into a high pressure liquid state. Heat transfer takes place because discharged gas is at a higher temperature than air that is passing over condenser. It is very important that adequate air flow over condenser is maintained.</p> <p>Condenser is air cooled by condenser fan motor. If efficiency of heat transfer from condenser to surrounding air is impaired, condensing temperature becomes higher. High liquid temperature means liquid will not remove as much heat during boiling in evaporator as under normal conditions. This would be indicated by high than normal head pressures, long run time, and high wattage. Remove any lint or other accumulation, that would restrict normal air movement through condenser.</p> <p>From condenser the refrigerant flows into a post condenser loop which helps control exterior condensation on flange, center mullion, and around freezer door. Refrigerant the flows through the drier to evaporator and into compressor through suction line.</p>	<p>Leaks in condenser can usually be detected by using an electronic leak detector or soap solution. Look for signs of compressor oil when checking for leaks. A certain amount of compressor oil is circulated with refrigerant.</p> <p>Leaks in post condenser loop are rare because loop is a one-piece copper tube.</p> <p>For minute leaks</p> <ol style="list-style-type: none"> 1. Separate condenser from rest of refrigeration system and pressurize condenser up to a maximum of 235 PSI with a refrigerant and dry nitrogen combination. 2. Recheck for leaks. <div style="border: 1px solid black; padding: 5px; margin-top: 10px;">  <h3 style="margin: 0;">WARNING</h3> <p>To avoid severe personal injury or death from sudden eruption of high pressures gases, observe the following: Protect against a sudden eruption if high pressures are required for leak checking. Do not use high pressure compressed gases in refrigeration systems without a reliable pressure regulator and pressure relief valve in the lines.</p> </div>

Component Testing



WARNING

To avoid risk of electrical shock, personal injury, or death, disconnect electrical power source to unit, unless test procedures require power to be connected. Discharge capacitor through a resistor before attempting to service. Ensure all ground wires are connected before certifying unit as repaired and/or operational.

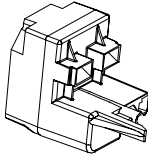
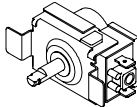
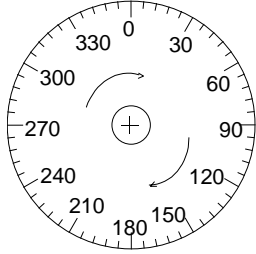
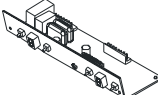
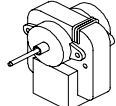

Component	Description	Test Procedures														
 Overload / Relay	<p>When voltage is connected and relay is cool, current passes through relay to start winding.</p> <p>After a short time, current heats the resistor in relay and resistance will rise blocking current flow through relay.</p> <p>Start winding remains in the circuit through run capacitor.</p> <p>Solid state relay plugs directly on compressor start and run terminals. Relay terminals 2 and 3 are connected within relay. Run capacitor is connected to relay terminal 3. L2 side of 120 VAC power is connected to relay terminal 2.</p>	<ol style="list-style-type: none"> 1. Disconnect power to the refrigerator. 2. Remove relay cover and disconnect leads. 3. Check resistance across terminals 2 and 3 with an ohmmeter: Normal = 3 to 12 ohms Shorted = 0 ohms Open = infinite ohms 														
 Freezer temperature control	<p>Freezer temperature control is a capillary tube operating a single pole, single throw switch.</p> <p>Freezer temperature control controls run cycle through defrost timer.</p> <p>Altitude Adjustment When altitude adjustment is required on a G.E. control, turn altitude adjustment screw 1/7 turn counter clockwise for each 1,000 feet increase in altitude up to 10,000 feet. One full turn equals 10,000 feet maximum.</p> <p>In most cases the need for altitude adjustments can be avoided by simply turning temperature control knob to colder setting.</p>	<p>Check for proper calibration with thermocouple capillary in air supply well by recording cut-in and cut-out temperatures at middle setting. Refer to tech sheet for model being serviced for expected temperatures.</p> <p>Check control contacts are opening by disconnecting electrical leads to control and turning control knob to coldest setting. Check for continuity across terminals.</p> <table border="1" data-bbox="760 1012 1107 1285"> <thead> <tr> <th colspan="2">Altitude Counter in Feet</th> </tr> <tr> <th>Feet Above Sea Level</th> <th>Turn Screw Clockwise (Angular Degrees)</th> </tr> </thead> <tbody> <tr> <td>2,000</td> <td>30</td> </tr> <tr> <td>4,000</td> <td>81</td> </tr> <tr> <td>6,000</td> <td>129</td> </tr> <tr> <td>8,000</td> <td>174</td> </tr> <tr> <td>10,000</td> <td>216</td> </tr> </tbody> </table> 	Altitude Counter in Feet		Feet Above Sea Level	Turn Screw Clockwise (Angular Degrees)	2,000	30	4,000	81	6,000	129	8,000	174	10,000	216
Altitude Counter in Feet																
Feet Above Sea Level	Turn Screw Clockwise (Angular Degrees)															
2,000	30															
4,000	81															
6,000	129															
8,000	174															
10,000	216															
 Control board	<p>On some models.</p> <p>See "Control Board" section for troubleshooting information.</p>															
Ice maker	<p>Optional on some models.</p> <p>See "Ice Maker" section for service information.</p>															
 Evaporator fan motor	<p>Evaporator fan moves air across evaporator coil and throughout refrigerator cabinet.</p>	<ol style="list-style-type: none"> 1. Disconnect power to unit. 2. Disconnect fan motor leads. 3. Check resistance from ground connection solder. Trace to motor frame must not exceed .05 ohms. 4. Check for voltage at connector to motor with unit in refrigeration mode and compressor operating. 														

Component Testing



WARNING

To avoid risk of electrical shock, personal injury, or death, disconnect electrical power source to unit, unless test procedures require power to be connected. Discharge capacitor through a resistor before attempting to service. Ensure all ground wires are connected before certifying unit as repaired and/or operational.

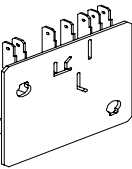
Component	Description	Test Procedures
 <p>Switch, refrigerator light,</p>	Single pole, single throw switch completes circuit for light when door is open.	<p>Check resistant across terminals.</p> <p>Switch arm depressed "NO" terminals Open</p> <p>Switch arm up "NO" terminals Closed</p>
 <p>Switch, freezer light</p>	Single pole, double throw switch completes circuit for light when door is open. Opens circuit to icemaker when door is open.	<p>Check resistant across terminals.</p> <p>Switch arm depressed "NO" terminals Open "NC" terminals Closed</p> <p>Switch arm up "NO" terminals Closed "NC" terminals Open</p>
<p>Switch, water dispenser</p>	Single pole, single throw switch completes circuit for water solenoid when button is depressed.	<p>Check resistant across terminals.</p> <p>Water button not depressed "NO" terminals Open</p> <p>Water button depressed "NO" terminals Closed</p>
 <p>Drier</p>	<p>Drier is placed at post condenser loop outlet and passes liquefied refrigerant to capillary.</p> <p>Desiccant (20) 8 x 12 4AXH - 7 M>S> - Grams</p>	<p>Drier must be changed every time the system is opened for testing or compressor replacement.</p> <p>NOTE: Drier used in R12 sealed system is not interchangeable with drier used in R134a sealed system. Always replace drier in R134a system with Amana part number B2150504.</p> <p>Before opening refrigeration system, recover HFC134a refrigerant for safe disposal.</p> <ol style="list-style-type: none"> 1. Cut drier out of system using the following procedure. Do not unbraid drier. 2. Applying heat to remove drier will drive moisture into the system. 3. Score capillary tube close to drier and break. 4. Reform inlet tube to drier allowing enough space for large tube cutter. 5. Cut circumference of drier 1/4" below condenser inlet tube joint to drier. 6. Remove drier. 7. Apply heat trap paste on post condenser tubes to protect grommets from high heat. 8. Unbraid remaining part of drier. Remove drier from system. 9. Discard drier in safe place. Do not leave drier with customer. If refrigerator is under warranty, old drier must accompany warranty claim.
 <p>Adaptive defrost control (ADC)</p>	The ADC adapts the compressor run time between defrosts to achieve optimum defrost intervals by monitoring the cold control and length the defrost heater is on.	Refer to specific Technical Data Sheet with unit for troubleshooting procedure.



WARNING



To avoid death or severe personal injury, cut drier at correct location. Cutting drier at incorrect location will allow desiccant beads to scatter. If spilled, completely clean area of beads.

Component Testing

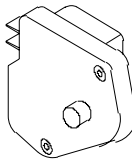
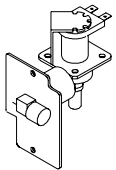

WARNING

To avoid risk of electrical shock, personal injury, or death, disconnect electrical power source to unit, unless test procedures require power to be connected. Discharge capacitor through a resistor before attempting to service. Ensure all ground wires are connected before certifying unit as repaired and/or operational.

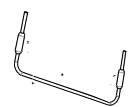
Component	Description	Test Procedures
 <p>Defrost timer</p>	<p>Timer motor operates only when freezer control is closed.</p> <p>After specified amount of actual operating time, inner cam in timer throws the contacts from terminal 4, compressor circuit, to terminal 2, defrost thermostat/defrost heater circuit.</p> <p>After specified defrost cycle time, timer cam resets the circuitry through terminal 4 to compressor.</p>	<ol style="list-style-type: none"> To check timer motor winding, check for continuity between terminals 1 and 3 of timer. Depending on rotating position of the cam, terminal 1 of timer is common to both terminal 2, the defrost mode, and terminal 4, the compressor mode. There should never be continuity between terminals 2 and 4. With continuity between terminals 1 and 4, rotate timer knob clockwise until audible click is heard. When the click is heard, reading between terminals 1 and 4 should be infinite and there should be continuity between terminals 1 and 2. Continuing to rotate time knob until a second click is heard should restore circuit between terminals 1 and 4.
 <p>Water valve</p>	<p>Controls water flow to the ice maker.</p> <p>Controlled by thermostat in ice maker.</p> <p>See Ice Maker Section for further information.</p>	<p>Check resistance across coil windings.</p>
<p>Evaporator</p>	<p>Inner volume of evaporator allows liquid refrigerant discharged from capillary to expand into refrigerant gas.</p> <p>Expansion cools evaporator tube and fin temperature to approximately -20°F transferring heat from freezer section to refrigerant.</p> <p>Passing through suction line to compressor, the refrigerant picks up superheat (a relationship between pressure and temperature that assures complete vaporization of liquid refrigerant) as the result of capillary tube soldered to suction line.</p> <p>Refrigerant gas is pulled through suction line by compressor, completing refrigeration cycle.</p>	<p>Test for leaks in evaporator with electronic leak detector or with soap solution. Compressor oil is circulated with refrigerant; check for oil when checking for leaks.</p> <p>For minute leaks</p> <ol style="list-style-type: none"> Separate evaporator from rest of refrigeration system and pressurize evaporator up to a maximum of 140 PSI with a refrigerant and dry nitrogen combination. Recheck for leaks.
 <h2>WARNING</h2> <p>To avoid severe personal injury or death from sudden eruption of high pressures gases, observe the following: Protect against a sudden eruption if high pressures are required for leak checking. Do not use high pressure compressed gases in refrigeration systems without a reliable pressure regulator and pressure relief valve in the lines.</p>		
 <p>Evaporator heater (defrost)</p>	<p>Activated when defrost thermostat, defrost timer, and freezer control complete circuit through heater.</p>	<p>Check resistance across heater.</p> <p>To check defrost system :</p> <ol style="list-style-type: none"> Thermocouple defrost thermostat and plug refrigerator into wattmeter. Turn into defrost mode. Wattmeter should read specified watts (according to Technical Data Sheet). When defrost thermostat reaches specified temperature $\pm 5^\circ\text{F}$ (see Technical Data Sheet), thermostat should interrupt power to heater.
<p>Thermostat (defrost)</p>	<p>Thermostat is in a series circuit with terminal 2 of defrost timer, and defrost heater. Circuit is complete if evaporator fan motor operates when cold.</p> <p>Controls the circuit from freezer thermostat through defrost terminator to defrost heater. Opens and breaks circuit when thermostat senses preset high temperature.</p>	<p>Test continuity across terminals.</p> <p>With power off and evaporator coil below freezing, thermostat should show continuity when checked with ohmmeter. See "Heater, evaporator (defrost)" section for additional tests.</p> <p>After defrost thermostat opens, thermostat remains open until end of defrost cycle and refrigerator starts cooling again. Defrost thermostat senses a preset low temperature and resets (closes).</p>

Component Testing



WARNING

To avoid risk of electrical shock, personal injury, or death, disconnect electrical power source to unit, unless test procedures require power to be connected. Discharge capacitor through a resistor before attempting to service. Ensure all ground wires are connected before certifying unit as repaired and/or operational.

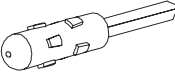
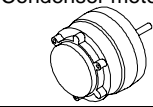
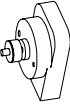
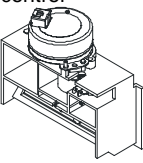
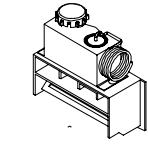
Component	Description	Test Procedures								
 <p>Thermistor</p>	Temperature sensing device	<p>Check resistance across leads.</p> <table border="0"> <tr> <td>Temperature</td> <td>Resistance</td> </tr> <tr> <td>77°F</td> <td>10,000 ohms</td> </tr> <tr> <td>36°F</td> <td>29,500 ohms</td> </tr> <tr> <td>0°F</td> <td>86,300 ohms</td> </tr> </table>	Temperature	Resistance	77°F	10,000 ohms	36°F	29,500 ohms	0°F	86,300 ohms
Temperature	Resistance									
77°F	10,000 ohms									
36°F	29,500 ohms									
0°F	86,300 ohms									
 <p>Condenser motor</p>	<p>Condenser fan moves cooling air across condenser coil and compressor body.</p> <p>Condenser fan motor is in parallel circuit with compressor.</p>	Check resistance across coil.								
 <p>ECM condenser motor</p>	<p>Condenser fan moves cooling air across condenser coil and compressor body.</p> <p>Condenser fan motor is in parallel circuit with compressor.</p>	Check resistance across coil.								
 <p>Electric damper control</p>	<p>Damper control balances the air delivery between refrigerator and freezer compartments providing temperature control for refrigerator.</p> <p>Electrical voltage activates damper control and door closes restricting flow of air from freezer compartment to refrigerator compartment.</p>	<p>Check resistance across terminals.</p> <p>If no resistance across terminals replace damper control.</p>								
 <p>Damper control</p>	<p>Damper control balances the air delivery between refrigerator and freezer compartments providing temperature control for refrigerator.</p> <p>Internal capillary activates damper control and door closes restricting flow of air from freezer compartment to refrigerator compartment.</p>	<p>Subject capillary to appropriate temperature (refer to Technical Data Sheet for model being serviced).</p> <p>Damper door should close to within 1/4" of completely shut.</p> <p>If altitude adjustment is required, turn altitude adjustment screw 1/8 turn clockwise for each 1,000 feet increase in altitude.</p> <p>There are no electrical connections to damper control. See Technical Data Sheet for damper specifications for unit being serviced.</p>								

Service Procedures



WARNING

To avoid risk of electrical shock, personal injury, or death, disconnect electrical power source to unit, unless test procedures require power to be connected. Discharge capacitor through a 10,000 ohm resistor before attempting to service. Ensure all ground wires are connected before certifying unit as repaired and/or operational.

Service Equipment

Listed below is equipment needed for proper servicing of HFC134a systems. Verify equipment is confirmed by manufacturer as being compatible with HFC134a and ester oil system.

Equipment must be exclusively used for HFC134a.

Exclusive use of equipment only applies to italic items.

- **Evacuation pump**

Check with vacuum pump supplier to verify equipment is compatible for HFC134a. Robinair, Model 15600 2 stage, 6 cubic feet per minute pump is recommended.

- ***Four-way manifold gauge set, with low loss hoses***

- **Leak detector**

- ***Charging cylinder***

- ***Line piercing saddle valve***

(Schroeder valves). Seals must be HFC134a and ester oil compatible. Line piercing valves may be used for diagnosis but are not suitable for evacuation or charging, due to minute holes pierced in tubing. Do not leave mechanical access valves on system.

Valves eventually will leak. Molecules of HFC134a are smaller than other refrigerants and will leak where other refrigerants would not.

- ***Swagging tools***

- ***Flaring tools***

- ***Tubing cutter***

- **Flux**

- **Sil-Fos**

- **Silver solder**

- ***Oil for swagging and flaring***

Use only part # R0157532

- ***Copper tubing***

Use only part # R0174075 and # R0174076

- **Dry nitrogen**

99.5% minimum purity, with -40°F or lower dew point

- **Crimp tool**

- **Tube bender**

- **Micron vacuum gauge**

- ***Process tube adaptor kit***

- **Heat trap paste**

- ***ICI appliance grade HFC134a***

Drier Replacement

Before opening refrigeration system, recover HFC134a refrigerant for safe disposal.

Every time sealed HFC134a system is repaired, drier filter must be replaced with, part # B2150504.

Cut drier out of system by completing the following steps. Do not unbraid drier filter. Applying heat to remove drier will drive moisture into system.



WARNING

To avoid risk of severe personal injury or death, cut drier at correct location. Cutting drier at incorrect location will allow desiccant beads to scatter. Completely clean area of beads, if spilled.

1. Score capillary tube close to drier and break.
2. Reform inlet tube to drier allowing enough space for large tube cutter.
3. Cut circumference of drier at 1-1/4", below condenser inlet tube joint to drier.
4. Remove drier.
5. Apply heat trap paste on post condenser tubes to protect grommets from high heat.
6. Unbraid remaining part of drier. Remove drier from system.
7. Discard drier in safe place. Do not leave drier with customer. If refrigerator is under warranty, old drier must accompany warranty claim.

Service Procedures



WARNING

To avoid risk of electrical shock, personal injury, or death, disconnect electrical power source to unit, unless test procedures require power to be connected. Discharge capacitor through a 10,000 ohm resistor before attempting to service. Ensure all ground wires are connected before certifying unit as repaired and/or operational.

Refrigerant Precautions



WARNING

To avoid risk of personal injury, do not allow refrigerant to contact eyes or skin.



CAUTION

To avoid risk of property damage, do not use refrigerant other than that shown on unit serial number identification plate.

NOTE: All precautionary measures recommended by refrigerant manufacturers and suppliers apply and should be observed.

Line Piercing Valves

Line piercing valves can be used for diagnosis, but are not suitable for evacuating or charging due to holes pierced in tubing by valves.

NOTE: Do not leave line piercing valves on system. Connection between valve and tubing is not hermetically sealed. Leaks will occur.

Open Lines

During any processing of refrigeration system, never leave lines open to atmosphere. Open lines allow water vapor to enter system, making proper evacuation more difficult.

Compressor Operational Test

(short term testing only)

If compressor voltage, capacitor, overload, and motor winding tests are successful (do not indicate a fault), perform the following test:

1. Disconnect power to unit.
 2. Discharge capacitor by shorting capacitor terminals through a resistor.
- NOTE:** Not all units have run capacitor.
3. Remove leads from compressor terminals.
 4. Attach test cord to compressor windings.
 - Common lead on test cord attaches to C terminal on compressor.
 - Start lead on test cord attaches to S terminal on compressor.
 - Run lead on test cord attaches to M terminal on compressor.

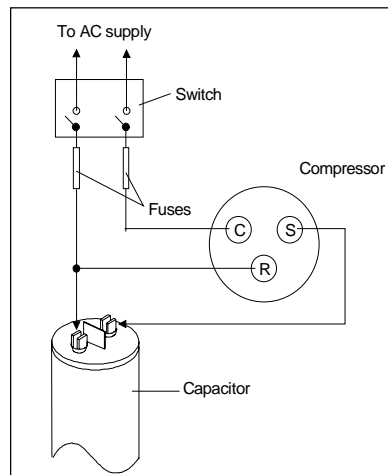

Attaching Capacitor for Compressor Test

5. Connect a known good capacitor into circuit as shown above. For proper capacitor size and rating, see technical data sheet for unit under test.

NOTE: Ensure test cord cables and fuses meet specifications for unit under test (see Technical Sheet for unit under test).

6. Replace compressor protector cover securely.
7. Plug test cord into outlet, then press and release start cord switch.



CAUTION

To avoid risk of damage to compressor windings, immediately disconnect (unplug) test cord from power source if compressor does not start. Damage to compressor windings occurs if windings remain energized when compressor is not running.

If compressor runs when direct wired, it is working properly. Malfunction is elsewhere in system.

If compressor does not start when direct wired, recover system at high side. After the system is recovered, repeat compressor direct wire test.

If compressor runs after system is recovered (but would not operate when wired direct before recovery) a restriction in sealed system is indicated.

If motor does not run when wired direct after recovery, replace faulty compressor.

Service Procedures



WARNING

To avoid risk of electrical shock, personal injury, or death, disconnect electrical power source to unit, unless test procedures require power to be connected. Discharge capacitor through a 10,000 ohm resistor before attempting to service. Ensure all ground wires are connected before certifying unit as repaired and/or operational.

Dehydrating Sealed Refrigeration System

Moisture in a refrigerator sealed system exposed to heat generated by the compressor and motor reacts chemically with refrigerant and oil in the system and forms corrosive hydrochloric and hydrofluoric acids. These acids contribute to breakdown of motor winding insulation and corrosion of compressor working parts, causing compressor failure.

In addition, sludge, a residue of the chemical reaction, coats all surfaces of sealed system, and will eventually restrict refrigerant flow through capillary tube.

To dehydrate sealed system, evacuate system (see paragraph *Evacuation*).

Leak Testing



DANGER

To avoid risk of serious injury or death from violent explosions, NEVER use oxygen or acetylene for pressure testing or clean out of refrigeration systems. Free oxygen will explode on contact with oil. Acetylene will explode spontaneously when put under pressure.

It is important to check sealed system for refrigerant leaks. Undetected leaks can lead to repeated service calls and eventually result in system contamination, restrictions, and premature compressor failure.

Refrigerant leaks are best detected with halide or electronic leak detectors.

Testing Systems Containing a Refrigerant Charge

1. Stop unit operation (turn refrigerator off).
2. Holding leak detector exploring tube as close to system tubing as possible, check all piping, joints, and fittings.

NOTE: Use soap suds on areas leak detector cannot reach or reliably test.

Testing Systems Containing No Refrigerant Charge

1. Connect cylinder of nitrogen, through gauge manifold, to process tube of compressor and liquid line strainer.
2. Open valves on nitrogen cylinder and gauge manifold. Allow pressure to build within sealed system.
3. Check for leaks using soap suds.

If a leak is detected in a joint, do not attempt to repair by applying additional brazing material. Joint must be disassembled, cleaned and rebrazed. Capture refrigerant charge (if system is charged), unbrazed joint, clean all parts, then rebraze.

If leak is detected in tubing, replace tubing. If leak is detected in either coil, replace faulty coil.

Service Procedures



WARNING

To avoid risk of electrical shock, personal injury, or death, disconnect electrical power source to unit, unless test procedures require power to be connected. Discharge capacitor through a 10,000 ohm resistor before attempting to service. Ensure all ground wires are connected before certifying unit as repaired and/or operational.

Restrictions

Symptoms

Restrictions in sealed system most often occur at capillary tube or filter drier, but can exist anywhere on liquid side of system.

Restrictions reduce refrigerant flow rate and heat removal rate. Wattage drops because compressor is not circulating normal amount of refrigerants.

Common causes of total restrictions are moisture, poorly soldered joints, or solid contaminants. Moisture freezes at evaporator inlet end of capillary tube. Solid contaminants collect in filter drier.

If restriction is on low side, suction pressure will be in a vacuum and head pressure will be near normal.

If restriction is on high side, suction pressure will be in a vacuum and head pressure will be higher than normal during pump out cycle.

Refrigeration occurs on low pressure side of partial restriction. There will be a temperature difference at the point of restriction. Frost and/or condensation will be present in most case at the point of restriction. Also, system requires longer to equalize.

Slight or partial restriction can give the same symptoms as refrigerant shortage including lower than normal back pressure, head pressure, wattage, and warmer temperatures.

Total restriction on the discharge side of compressor, when restriction is between compressor and first half of condenser, results in higher than normal head pressure and wattage while low side is being pumped out.

Testing for Restrictions

To determine if a restriction exists:

1. Attach gauge and manifold between suction and discharge sides of sealed system.
2. Turn unit on and allow pressure on each side to stabilize. Inspect condenser side of system. Tubing on condenser should be warm and temperature should be equal throughout (no sudden drops at any point along tubing).
 - If temperature of condenser tubing is consistent throughout, go to step 4.
 - If temperature of condenser tubing drops suddenly at any point, tubing is restricted at point of temperature drop (if restriction is severe, frost may form at point of restriction and extend down in direction of refrigerant flow in system). Go to step 5.

3. Visually check system for kinks in refrigeration line which is causing restriction. Correct kink and repeat step 2.
 4. Turn unit off and time how long it takes high and low pressure gauges to equalize:
 - If pressure equalization takes longer than 10 minutes, a restriction exists in the capillary tube or drier filter. Go to step 5.
 - If pressure equalization takes less than 10 minutes, system is not restricted. Check for other possible causes of malfunction.
 5. Recover refrigerant in sealed system.
- NOTE:** Before opening any refrigeration system, capture refrigerant in system for safe disposal.
6. Remove power from unit.



CAUTION

To avoid risk of personal injury or property damage, take necessary precautions against high temperatures required for brazing.

7. Remove and replace restricted device.
 8. Evacuate sealed system.
 9. Charge system to specification.
- NOTE:** Do not use captured or recycled refrigerant in units. Captured or recycled refrigerant voids any compressor manufacturer's warranty.
- NOTE:** Charge system with exact amount of refrigerant. Refer to unit nameplate for correct refrigerant charge. Inaccurately charged system will cause future problems.

Service Procedures



WARNING

To avoid risk of electrical shock, personal injury, or death, disconnect electrical power source to unit, unless test procedures require power to be connected. Discharge capacitor through a 10,000 ohm resistor before attempting to service. Ensure all ground wires are connected before certifying unit as repaired and/or operational.

Evacuation and Charging



CAUTION

To avoid risk of fire, sealed refrigeration system must be air free. To avoid risk of air contamination, follow evacuation procedures exactly.

NOTE: Before opening any refrigeration system, EPA regulations require refrigerant in system to be captured for safe disposal.

Proper evacuation of sealed refrigeration system is an important service procedure. Usable life and operational efficiency greatly depends upon how completely air, moisture and other non-condensables are evacuated from sealed system.

Air in sealed system causes high condensing temperature and pressure, resulting in increased power requirements and reduced performance.

Moisture in sealed system chemically reacts with refrigerant and oil to form corrosive hydrofluoric and hydrochloric acids. These acids attack motor windings and parts, causing premature breakdown.

Before opening system, evaporator coil must be at ambient temperature to minimize moisture infiltration into system.

Evacuation

To evacuate sealed refrigeration system:

1. Connect vacuum pump, vacuum tight manifold set with high vacuum hoses, thermocouple vacuum gauge and charging cylinder as shown in illustration. Evacuation should be done through I.D. opening of tubes not through line piercing valve.
2. Connect low side line to compressor process tube.
3. Connect high side line to drier/process tube.
4. Evacuate both simultaneously. With valve "C" and "F" closed, open all other valves and start vacuum pump.

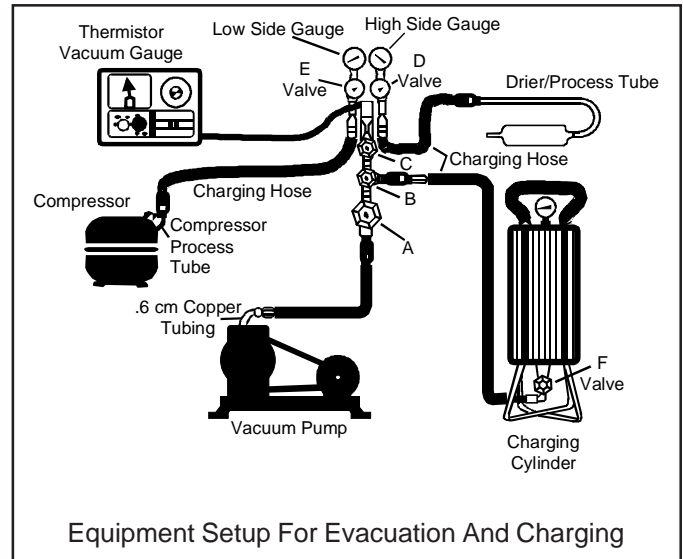

5. After compound gauge (low side) drops to approximately 29 inches gauge, open valve "C" to vacuum thermocouple gauge and take micron reading.
6. Continue evacuating system until vacuum gauge registers 600 microns.
7. At 600 microns, close valve "A" to vacuum pump and allow micron reading in system to balance. Micron level will rise.

- If in 2 minutes, micron level stabilizes at 1000 microns or below, system is ready to be charged.
- If micron level rises above 1000 microns and stabilizes, open valve "A" and continue evacuating.
- If micron reading rises rapidly and does not stabilize, a leak still exists in system.

Close valve "A" to vacuum pump and valve "C" to vacuum gauge. Invert charging cylinder and open charging cylinder valve "F" to add partial charge for leak checking. With leak detector, check manifold connections and system for leaks. After locating leak, capture refrigerant, repair leak, and begin at step 1.

Service Procedures



WARNING

To avoid risk of electrical shock, personal injury, or death, disconnect electrical power source to unit, unless test procedures require power to be connected. Discharge capacitor through a 10,000 ohm resistor before attempting to service. Ensure all ground wires are connected before certifying unit as repaired and/or operational.

Charging

NOTE: Do not use captured or recycled refrigerant in units. Captured or recycled refrigerant voids any warranty.

NOTE: Charge system with exact amount of refrigerant. Refer to unit serial plate for correct refrigerant charge. Inaccurately charged system will cause future problems.

To charge system:

1. Close valves "A" to vacuum pump and "C" to vacuum gauge and "E" to low side manifold gauge.
2. Set scale on dial-a-charge cylinder for corresponding HFC134a pressure reading.
3. Open valve "F" to charging cylinder and let exact amount of refrigerant flow from cylinder into system. Close valve.
Low side gauge pressure should rise shortly after opening charging cylinder valve as system pressure equalizes through capillary tube.
If pressure does not equalize, a restriction typically exists at capillary/drier braze joint.
4. If pressure equalizes, open valve "E" to low side manifold gauge and pinch off high side drier process tube.
5. Start compressor and draw remaining refrigerant from charging hoses and manifold into compressor through compressor process tube.
6. To check high side pinch-off drier process tube. Close valve "D" to high side gauge. If high side pressure rises, repeat high side pinch-off and open valve "D". Repeat until high side pinch-off does not leak.
7. Pinch-off compressor process tube and remove charging hose. Braze stub closed while compressor is operating.
8. Disconnect power. Remove charging hose and braze high side drier process tube closed.
9. Recheck for refrigerant leaks.

Refrigerant Charge

Refrigerant charge in all capillary tube systems is critical and exact amount is required for proper performance. Factory charges are shown on serial plate.

NOTE: Do not use refrigerant other than shown on serial plate.

Service Procedures



WARNING

To avoid risk of electrical shock, personal injury, or death, disconnect electrical power source to unit, unless test procedures require power to be connected. Discharge capacitor through a 10,000 ohm resistor before attempting to service. Ensure all ground wires are connected before certifying unit as repaired and/or operational.

HFC134a Service Information

HFC134a is alternative refrigerant for CFC12. HFC134a has an ozone depletion potential (ODP) factor of 0.0 and a global warming potential (GWP) factor of 0.27. HFC134a is not flammable and has acceptable toxicity levels. HFC134a is not interchangeable with CFC12. There are significant differences between HFC134a and CFC12 which must be considered when handling and processing refrigeration system.

Health, Safety, and Handling

Health, safety and handling considerations for HFC134A are virtually no different than those for CFC12.

Health, Safety, and Handling	CFC12	HFC134a
Allowable overall exposure limit	1,000 ppm	Same
Vapor exposure to skin	No effect	Same
Liquid exposure to skin	Can cause frostbite	Same
Vapor exposure to eye	Very slight eye irritant	Same
Liquid exposure to eye	Can cause frostbite	Same
Above minimum exposure limit	Can cause Asphyxiation, Tachycardia, and Cardia Arrhythmias	Same
Safety and handling	Wear appropriate skin and eye protection. Use with adequate ventilation.	Same
Spill management	Remove or extinguish ignition or combustion sources. Evacuate or ventilate area.	Same
Fire explosion hazards	May decompose if contact with flames and heating elements. Container may explode if heated due to resulting pressure rise. Combustion products are toxic.	Same
Disposal procedures	Recycle or reclaim.	Same



CAUTION

To minimize contamination, exercise extreme care when servicing HFC134A sealed systems.

- No trace of other refrigerants is allowed in HFC134a systems. Chlorinated molecules in other refrigerants such as CFC12, etc. will lead to capillary tube plugging.
 - Ester oil is used in HFC134a systems. Do not use mineral oil. HFC134a and mineral oils cannot be mixed. If mineral oils were used in HFC134a systems, lubricant would not return to compressor and would cause early compressor failure. If significant amount of oil has been lost from compressor, replace oil rather than adding oil.
 - Ester oils used in HFC134a systems are so hydroscopic that by the time an inadequate system performance is detected, oil will be saturated with moisture.
 - CFC12 has much higher tolerance to system processing materials, such as drawing compounds, rust inhibitors, and cleaning compounds, than HFC134a. Such materials are not soluble in HFC134a systems. If materials were to be washed from system surfaces by ester oils, they could accumulate and eventually plug capillary tube.
 - Care must be taken to minimize moisture entering HFC134a system. Do not leave compressor or system open to atmosphere for more than 10 minutes. Excessive moisture in HFC134a system will react with compressor oil and generate acid.
 - Compressor must be replaced when performing low side leak repair.
 - Drier filter must always be replaced with service drier filter, part #B2150504.
- Important:** Unbrazing drier filter from tubing will drive moisture from desiccant and into system, causing acids to form. Do not unbraid filter drier from tubing. If CFC12 service drier was installed in HFC134A system, drier could overload due to excessive moisture.
- HFC134a compatible copper tubing, part #R0174075 (1/4" O.D. X 18" length) and part #R0174076 (5/16" O.D. X 24" length) must be used when replacing tubing.
 - Avoid system contamination by using Towerdraw E610 evaporating oil, part # R0157532, when flaring, swagging, or cutting refrigeration tubing.

Service Procedures



WARNING

To avoid risk of electrical shock, personal injury, or death, disconnect electrical power source to unit, unless test procedures require power to be connected. Discharge capacitor through a 10,000 ohm resistor before attempting to service. Ensure all ground wires are connected before certifying unit as repaired and/or operational.

Replacement Service Compressor

HFC134a service compressors will be charged with ester oil and pressurized with dry nitrogen. Before replacement compressor is installed, pull out 1 rubber plug. A *pop* from pressure release should be heard. If a *pop* sound is not heard, do not use compressor. Positive pressure in compressor is vital to keep moisture out of ester oil. Do not leave compressor open to atmosphere for more than 10 minutes.

Compressor Testing Procedures



WARNING

To avoid death or severe personal injury, never use oxygen, air or acetylene for pressure testing or clean out of refrigeration system. Use of oxygen, air, or acetylene may result in violent explosion. Oxygen may explode on contact with oil and acetylene will spontaneously explode when under pressure.

Refer to Technical Data Sheet "Temperature Relationship Chart" for operating watts, test points, and temperature relationship test for unit being tested.

- Temperature testing is accomplished by using 3 lead thermocouple temperature tester in specific locations. Test point T-1 is outlet on evaporator coil and T-2 is inlet. Test point T-3 is suction tube temperature midway between where armafex ends and suction port of compressor (approximately 12 inches from compressor).
- Thermocouple tips should be attached securely to specified locations.
- Do not test during initial *pull down*. Allow one off cycle or balanced temperature condition to occur before proceeding with testing.
- Refrigerator must operate minimum of 20 minutes after thermocouples are installed.
- Turn control to colder to obtain required on time.
- Wattage reading must be recorded in conjunction with temperature test to confirm proper operation.
- Suction and head pressures are listed on "Temperature and Relationship Chart". Normally these are not required for diagnosis but used for confirmation on systems which have been opened.

Brazing



CAUTION

To avoid risk of personal injury or property damage, take necessary precautions against high temperatures required for brazing.

Satisfactory results require cleanliness, experience, and use of proper materials and equipment.

Connections to be brazed must be properly sized, free of rough edges, and clean.

Generally accepted brazing materials are:

- **Copper to copper joints:** SIL-FOS (alloy of 15 percent silver, 80 percent copper, and 5 percent phosphorous). Use without flux. Recommended brazing temperature is approximately 1400°F. **Do not use for copper to steel connection.**
- **Copper to steel joints:** SILVER SOLDER (alloy of 30 percent silver, 38 percent copper, 32 percent zinc). Use with fluoride based flux. Recommended brazing temperature is approximately 1200°F.
- **Steel to steel joints:** SILVER SOLDER (see copper to steel joints).
- **Brass to copper joints:** SILVER SOLDER (see copper to steel joints).
- **Brass to steel joints:** SILVER SOLDER (see copper to steel joints).

Refrigerant Flow

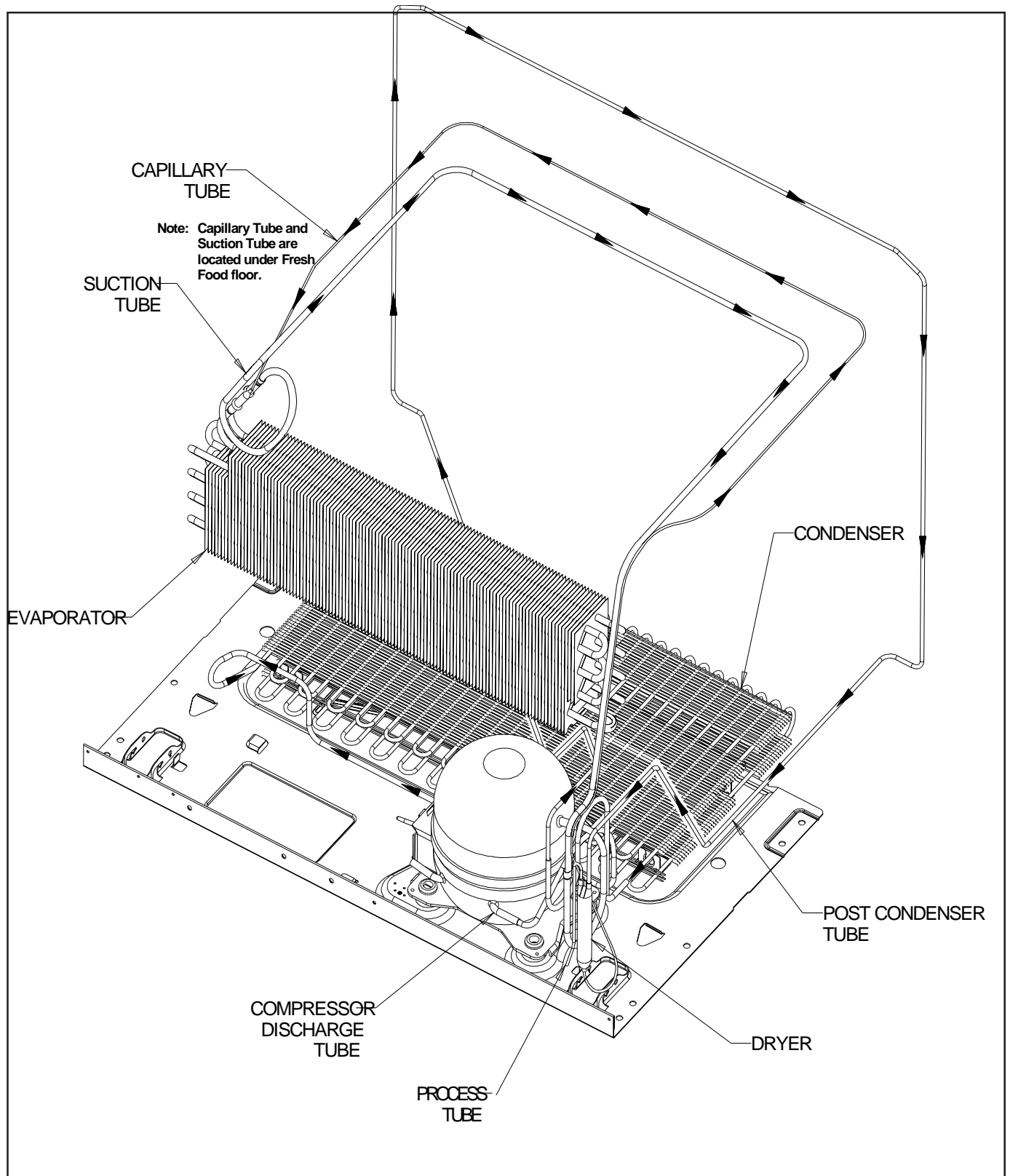

19, 20, 22, 25 cu. ft. Bottom Mount Refrigerant Flow Diagram

Cabinet Air Flow

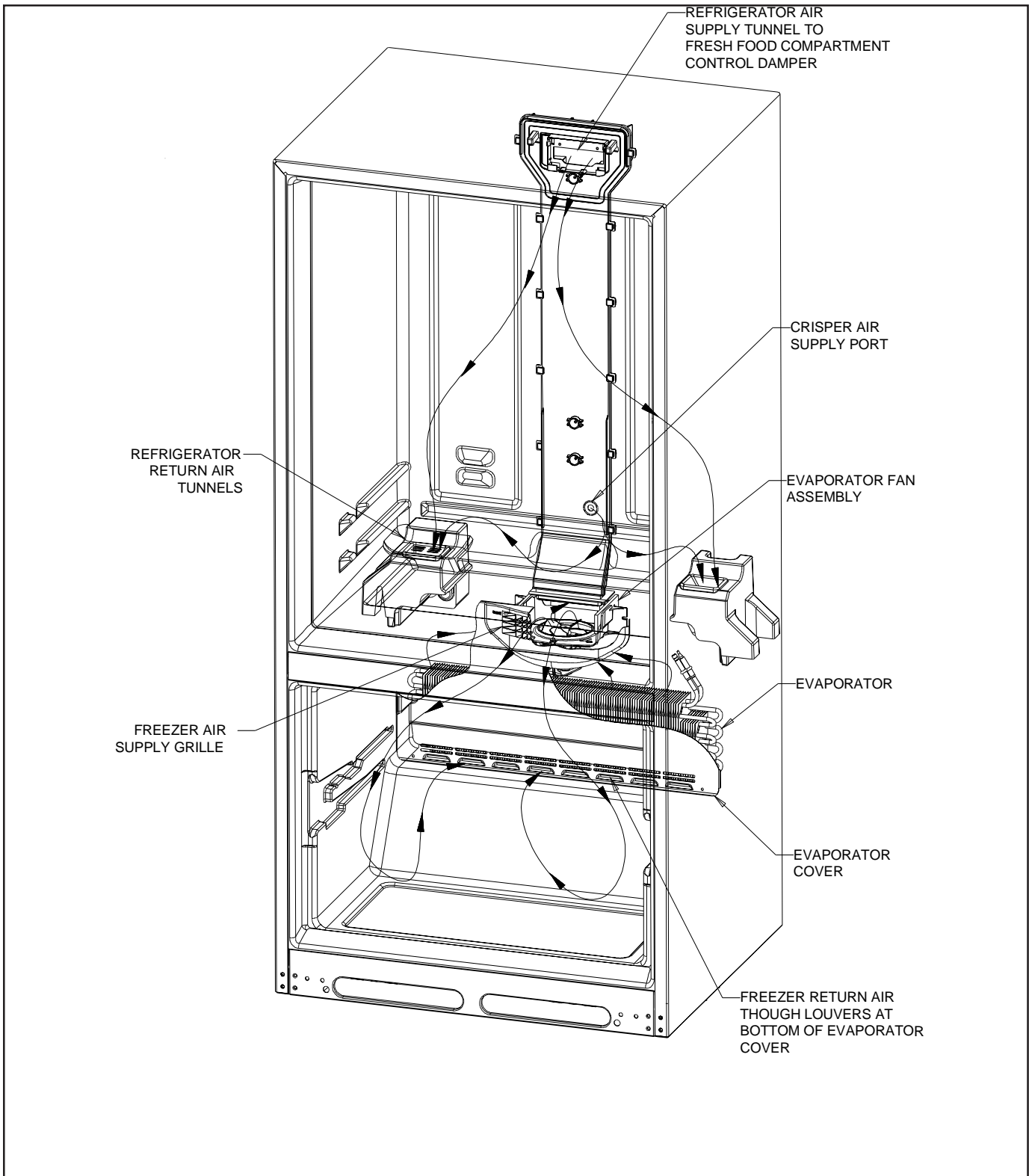

19, 20, 22, 25 cu. ft. Bottom Mount
Cabinet Air Flow Diagram

Machine Compartment Air Flow

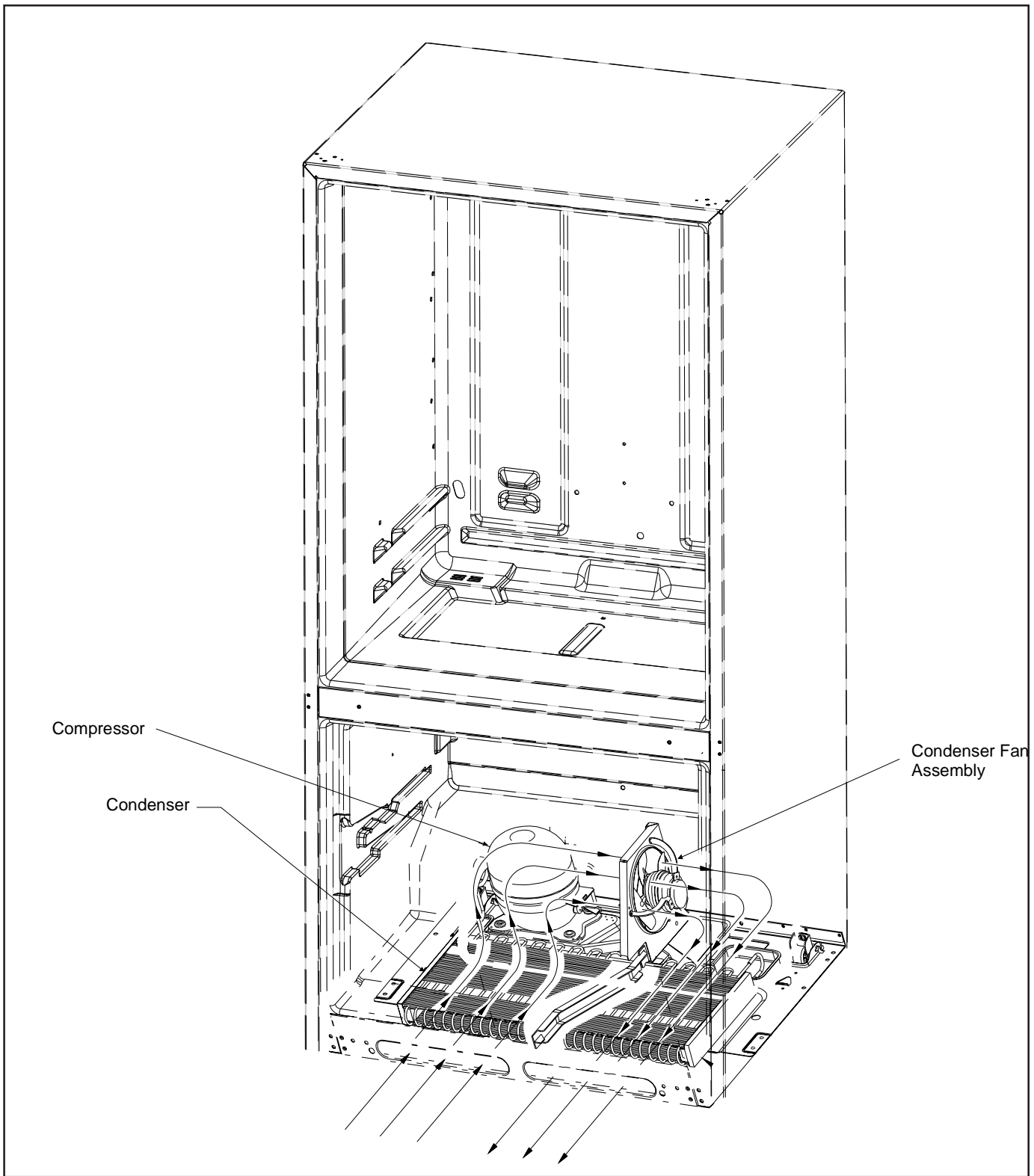

**20 cu. ft. Bottom Mount
Machine Compartment Air Flow Diagram**

Machine Compartment Air Flow

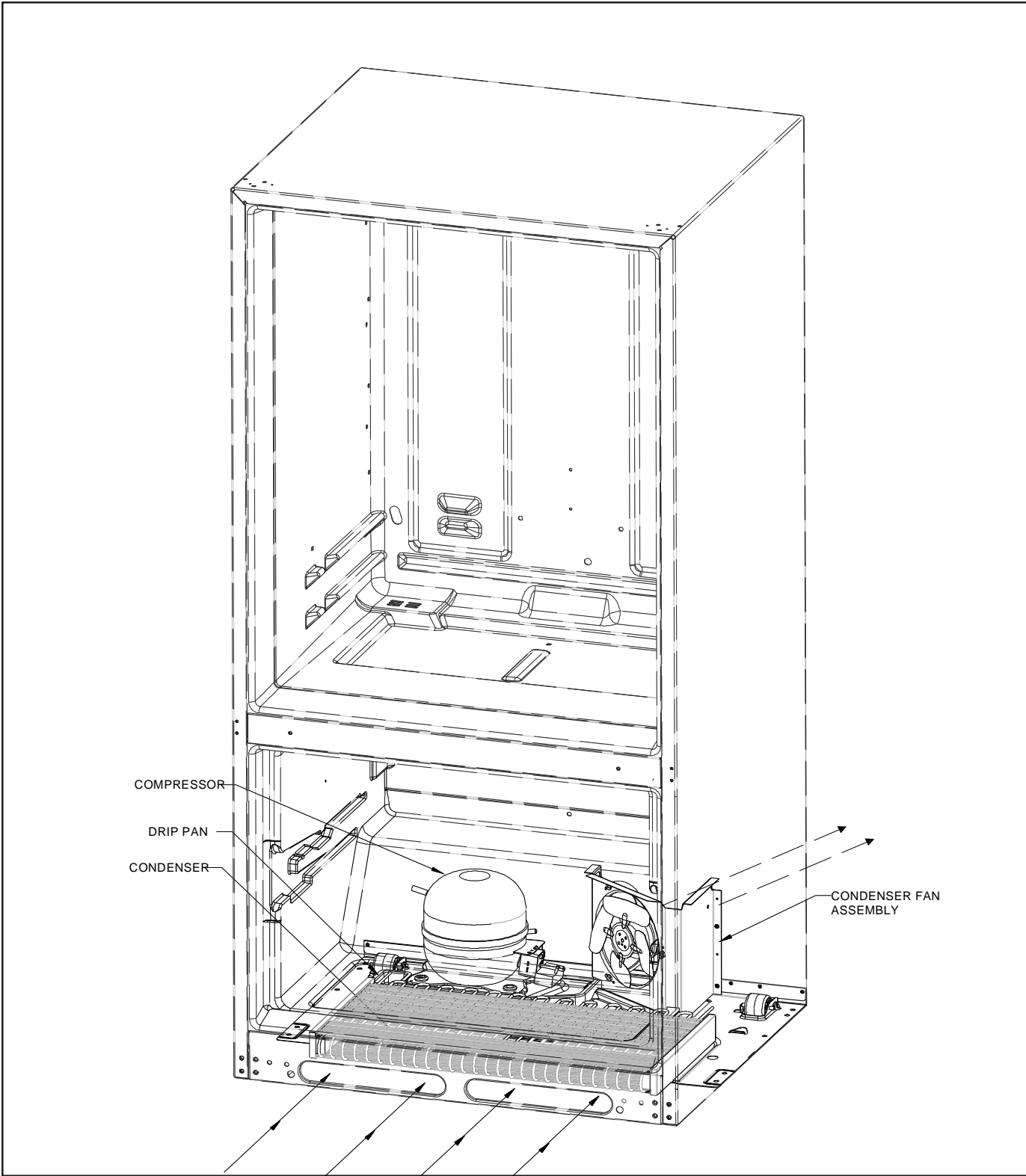

COMPRESSOR
DRIP PAN
CONDENSER

CONDENSER FAN ASSEMBLY

**19, 22, 25 cu. ft. Model Bottom Mount
Machine Compartment Air Flow Diagram**

Water Dispenser

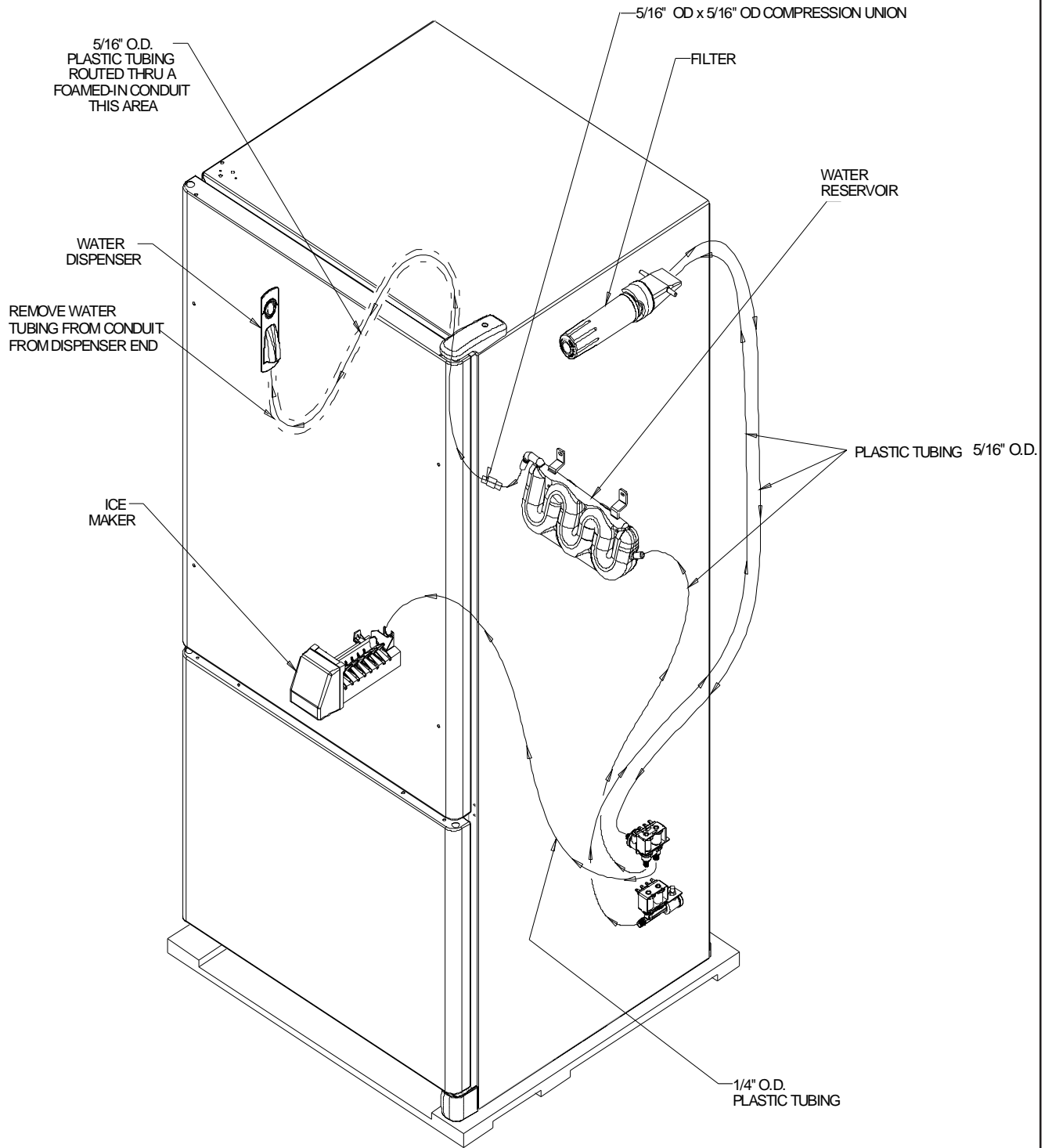

WATER DISPENSING FLOW

Typical External Sweat Pattern

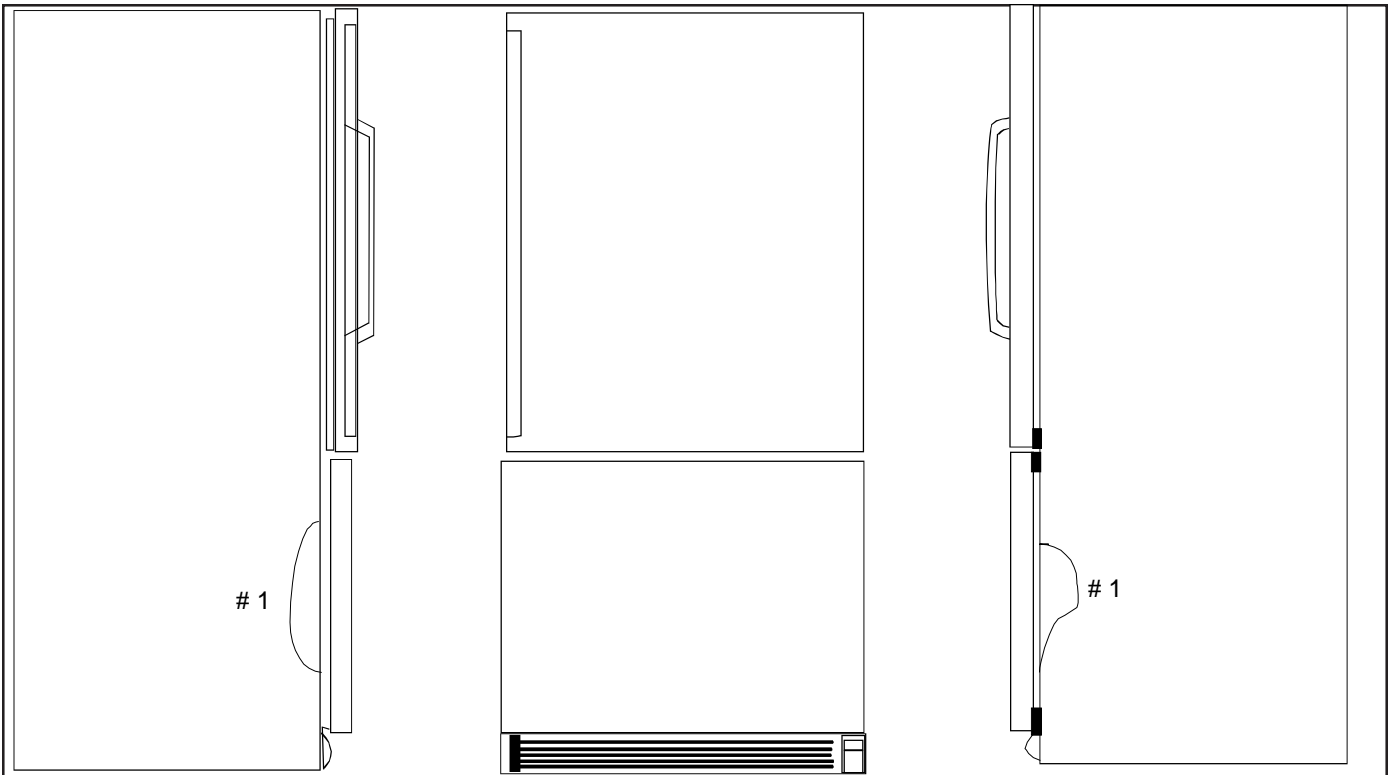

CLASSIFICATION OF CONDENSATION

- 1 = Haze or fog
- 2 = Beading
- 3 = Beads or small drops
- 4 = Drops running together

Conditions after 4 hour
Laboratory Sweat Test.
Ambient: 90 dF
Relative humidity 84%
Refrigerator Temp. 40 dF
Freezer Temp. 0 dF

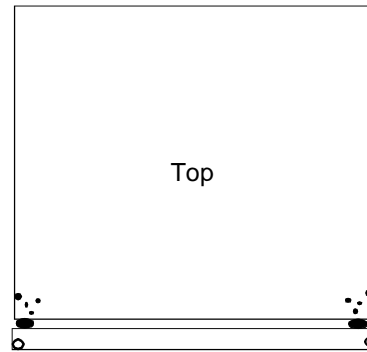
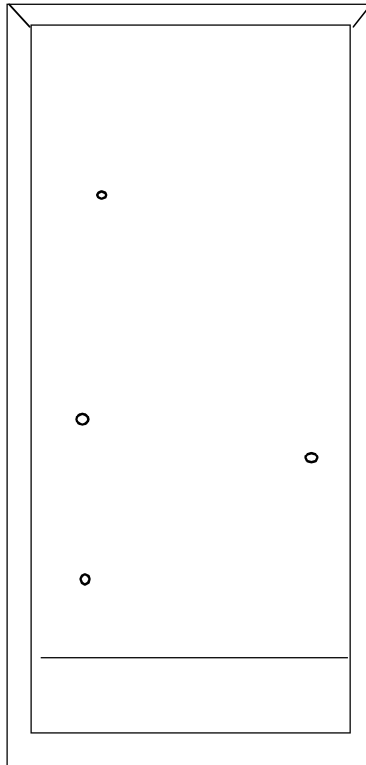

Refrigerator door bottom

No sweat on side when compressor is running

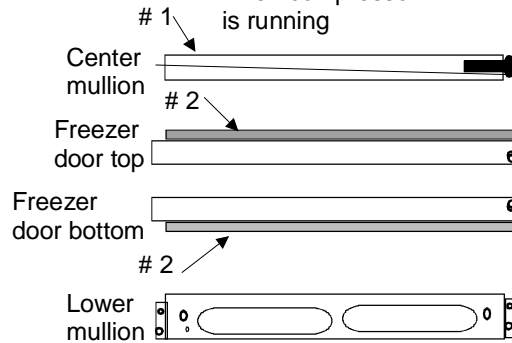

Troubleshooting Chart



WARNING

To avoid risk of electrical shock, personal injury, or death, disconnect electrical power source to unit, unless test procedures require power to be connected. Discharge capacitor through a resistor before attempting to service. Ensure all ground wires are connected before certifying unit as repaired and/or operational.

Troubleshooting chart on following pages contains symptoms that may be seen in malfunctioning units. Each symptom is accompanied by one or more possible causes and by a possible remedy or test to determine if components are working properly.

Symptom	Possible Causes	Corrective Action
Unit does not run	No power to unit	Check for power at outlet. Check fuse box/circuit breaker for blown fuse or tripped breaker. Replace or reset.
	Faulty power cord	Check with test light at unit; if no circuit and current is indicated at outlet, replace or repair.
	Low voltage	Check input voltage for proper voltage. Take appropriate action to correct voltage supply problem.
	Faulty motor or freezer temperature control	Check all connections are tight and secure. Jumper across terminals of control. If unit runs, replace control.
	Faulty timer	Check with test light. Replace if necessary.
	Faulty relay	Check relay. Replace if necessary.
	Faulty compressor	Check compressor motor windings for opens/shorts. Perform compressor direct wiring test. Replace if necessary.
	Faulty overload	Check overload for continuity. NOTE: Ensure compressor/overload are below trip temperature before testing. Replace if necessary.
Refrigerator section too warm	Excessive door opening	Consumer education
	Overloading of shelves	Consumer education
	Warm or hot foods placed in cabinet	Consumer education
	Cold control set too warm	Set control to colder setting.
	Poor door seal	Level cabinet. Adjust hinges. Replace gasket.
	Refrigerator airflow	Check damper is opening by removing grille. With door open, damper should open. Replace if faulty. Turn control knob to colder position.
	Interior light remains on	Check switch. Replace if necessary.
	Faulty condenser fan or evaporator fan	Check fan and wiring. Replace if necessary.
	Faulty compressor	Replace compressor.

Troubleshooting Chart



WARNING

To avoid risk of electrical shock, personal injury, or death, disconnect electrical power source to unit, unless test procedures require power to be connected. Discharge capacitor through a resistor before attempting to service. Ensure all ground wires are connected before certifying unit as repaired and/or operational.

Symptom	Possible Causes	Corrective Action
Refrigerator section too cold	Refrigerator temperature control set too cold	Adjust refrigerator temperature control.
	Refrigerator airflow not properly adjusted	Check air flow.
Freezer and refrigerator sections too warm	Temperature controls set too warm	Reset temperature controls.
	Poor door seal	Level cabinet. Adjust hinges. Replace gasket.
	Dirty condenser or obstructed grille	Check condenser and grille. Clean.
	Faulty control	Test control. Replace if failed.
	Refrigerant shortage or restriction	Check for leak or restriction. Repair, evacuate and recharge system.
Freezer section too cold	Freezer temp control set too cold	Adjust freezer temperature control.
	Faulty control	Test control. Replace if failed.
	Cold control capillary not properly clamped to evaporator	Reposition clamp and tighten.
Unit runs continuously	Temperature control set too cold	Adjust temperature control.
	Dirty condenser or obstructed grille	Check condenser and grille. Clean.
	Poor door seal	Level cabinet. Adjust hinges. Replace gasket.
	Interior light remains on	Check switch. Replace if necessary.
	Faulty condenser fan or evaporator fan	Check fan and wiring. Replace if necessary.
	Faulty control	Test control. Replace if failed.
	Refrigerant shortage or restriction	Check for leak or restriction. Repair, evacuate and recharge system.
	Refrigerant overcharge	Check for overcharge. Evacuate and recharge system.
	Air in system	Check for low side leak. Repair, evacuate and recharge system.
Unit runs continuously. Temperature normal.	Ice on evaporator	See "Ice on evaporator".
Unit runs continuously. Temperature too cold.	Faulty defrost thermostat	Check thermostat. Replace if necessary.
Noisy operation	Loose flooring or floor not firm	Repair floor or brace floor.
	Cabinet not level	Level cabinet.
	Tubing in contact with cabinet, other tubing, or other metal	Adjust tubing.
	Drip pan vibrating	Adjust drain pan.
	Fan hitting another part	Ensure fan properly aligned and all attaching hardware and brackets are tight and not worn. Tighten or replace.
	Worn fan motor bearings	Check motor for loss of lubricant or worn bearings. Replace if necessary.
	Compressor mounting grommets worn or missing. Mounting hardware loose or missing	Tighten hardware. Replace grommets if necessary.
	Free or loose parts causing or allowing noise during operation	Inspect unit for parts that may have worked free or loose or missing screws. Repair as required.

Troubleshooting Chart



WARNING

To avoid risk of electrical shock, personal injury, or death, disconnect electrical power source to unit, unless test procedures require power to be connected. Discharge capacitor through a resistor before attempting to service. Ensure all ground wires are connected before certifying unit as repaired and/or operational.

Symptom	Possible Causes	Corrective Action
Frost or ice on evaporator	Defrost thermostat faulty	Check defrost thermostat. Replace if failed.
	Evaporator fan faulty	Check fan motor. Replace if failed.
	Defrost heater remains open	Check defrost heater continuity. Replace if failed.
	Defrost control faulty	Check control and replace if failed.
	Open wire or connector	Check wiring and connections. Repair as necessary.
	Refrigerant shortage or restriction	Check for leak or restriction. Repair, evacuate and recharge system.
Unit starts and stops frequently (cycles on and off)	Loose wire or thermostat connections	Check wiring and connections. Repair as necessary.
	Supply voltage out of specification	Check input voltage. Correct any supply problems.
	Overload protector open	Check overload protector for continuity. If open, replace overload. NOTE: Ensure overload/compressor are below trip temperature before testing.
	Faulty compressor motor capacitor (some compressors do not require motor capacitor)	Check capacitor for open/short. Replace if necessary. NOTE: Discharge capacitor before testing.
	Faulty fan motor	Check fan motor. Replace if failed.
	Restricted air flow	Check condenser and grille for dirt. Clean.
	Refrigerant shortage or restriction	Check for leak or restriction. Repair, evacuate and recharge system.

System Diagnosis

CONDITION	SUCTION PRESSURE VARIATION FROM NORMAL	HEAD PRESSURE VARIATION FROM NORMAL	T1 INLET TEMPERATURE VARIATION FROM NORMAL	T2 OUTLET TEMPERATURE VARIATION FROM NORMAL	T3 SUCTION TEMPERATURE VARIATION FROM NORMAL	WATTAGE VARIATION FROM NORMAL
Refrigerant Overcharge	Increase	Increase	Warmer	Warmer	Colder	Increase
Shortage of Refrigerant	Decrease	Decrease or Increase See Text	Colder	Warmer	Warmer	Decrease
Partial Restriction	Decrease	Decrease or Increase See Text Note 2	Colder	Warmer	Warmer	Decrease
Air in System	Near Normal	Increase	Warmer	Warmer	Warmer	Increase
Low Ambient Installations (High Ambients the Reverse)	Decrease	Decrease	Colder	Warmer	Warmer	Decrease
Additional Heat Load	Increase	Increase	Warmer	Warmer	Warmer	Increase
Inefficient Compressor	Increase	Normal or Decrease	Warmer or Colder	Warmer	Warmer	Decrease

Symptoms of an Overcharge

- Above normal freezer temperatures.
- Longer than normal or continuous run.
- Freezing in refrigerator.
- Higher than normal suction and head pressure.
- Higher than normal wattage.
- Evaporator inlet and outlet temperatures warmer than normal.
- Suction tube temperature below ambient. Always check for separated heat exchanger when suction temperature is colder than ambient.

Various conditons could indicate an overcharge. For example, if the cooling coil is not defrosted at regular intervals, due to a failure of the defrost system, the refrigerant will "flood out" and cause the suction line to frost or sweat. The cause of this problem should be corrected rather than to purge refrigerant from the sytem. Running the freezer section colder than necessary (-2 to -1 F. is considered normal package temperatures) or continuous running of the compressor for a variety of reasons, or the freezer fan motor not running, may give the indication of an overcharge.

Symptoms of Refrigeration Shortage

- Rise in food product temperature in both compartments. (See Note 1 below.)
- Long or continuous run time.
- Look for obvious traces of oil that would occur due to a leak or cracked refrigerant line.
- Lower than normal wattage.
- Compressor will be hot to touch because of the heat generated by the motor windings from long continuous running. It will not be as hot as it would be with a full charge and long run times for some other reason such as a dirty condenser.
- Depending on the amount of the shortage, the condenser will not be hot, but closer to room temperature. The capillary tube will be warmer than normal from a slight shortage.
- If the leak is on the high side of the system, both gauges will show lower than normal readings and will show progressively lower readings as this charge becomes less. The suction pressure guage will probably indicate a vacuum.
- If the leak is on the low side of the system the suction pressure guage will be lower than normal - probably in a vacuum - and the head pressure gauge will be higher than normal. It will probably continue to become higher because air drawn in through the leak is compressed by the compressor and accumulates in

System Diagnosis

the high side (condenser) of the system.

- Only partial frosting of evaporator instead of even frosting of entire coil.

NOTE 1: Usually the first thing that is noticed by the user is a rise in temperature foods. Although temperatures will rise in both the freezer section and the food compartment, the frozen meats and vegetables will not thaw immediately. The customer doesn't associate the problem with the freezer section and will first notice that milk and other food beverages are not cold enough.

Under some circumstances, such as in the case of forced air meatkeeper model with a slight shortage of refrigerant, freezing in the food compartment may be experienced due to the additional running time. With a refrigerant leak, however, it always gets worse and as the refrigerant charge decreases the temperature will continue to rise.

With a shortage of refrigerant the capillary line will not have a full column of liquid. As a result, there is a noticeable hissing sound in the evaporator. This should not be mistaken for the regular refrigerant boiling sounds that would be considered normal.

Symptoms of a Restriction

Always remember refrigeration (cooling) occurs on the low pressure side of a partial restriction (obviously a total restriction will completely stop the circulation of refrigerant and no cooling will take place).

Physically feel the refrigeration lines when a restriction is suspected. The most common place for a restriction is at the drier-filter or at the capillary tube inlet or outlet. If the restriction is not total there will be a temperature difference at the point of restriction, the area on the evaporator side will be cooler. In many cases frost and/or condensation will be present. A longer time is required for the system to equalize.

Any kinked line will cause a restriction so the entire system should be visually checked.

A slight restriction will give the same indications as a refrigerant shortage with lower than normal back pressure, head pressure, and wattage, warmer product temperatures.

NOTE 2: If a total restriction is on the discharge side of the compressor, higher than normal head pressures and wattages would result. This is true only while the low side is being pumped out and if the restriction was between the compressor and the first half of the condenser.

To diagnose for a restriction versus a refrigerant shortage, discharge the system, replace the drier-filter, evacuate and recharge with the specified refrigerant charge. If the unit performs normally three possibilities exist: 1) refrigerant loss, 2) partially restricted drier-filter, and 3) moisture in system.

If the unit performs as it previously did you may have a restricted capillary line or condenser or kinked line. Find the point of restriction and correct it.

A restriction reduces the flow rate of the refrigerant and consequently reduces the rate of heat removal. Complete restriction may be caused by moisture, solid contaminants in the system, or a poorly soldered joint. Moisture freezes at the evaporator inlet end of the capillary tube or solid contaminants collect in the drier-filter. The wattage drops because the compressor is not circulating the usual amount of refrigerant.

As far as pressure readings are concerned, if the restriction, such as a kinked line or a joint soldered shut is anywhere on the low side, the suction pressure would probably be in a vacuum while the head pressure will be near normal. If the restriction is on the high side, the suction pressure, again, will probably be in a vacuum while the head pressure will be higher than normal during the pump out period described earlier. In either case, it will take longer than the normal ten minutes or so for the head pressure to equalize with the low side after the compressor stops.

Symptoms of Air in System

This can result from a low side leak or improper servicing. If a leak should occur on the low side, the temperature control would not be satisfied; thus, continuous running of the compressor would result. The compressor would eventually pump the low side into a vacuum drawing air and moisture into the system. Air and R134A do not mix so the air pressure would be added to the normal head pressure, resulting in higher than normal head pressures.

One way to determine if air is in the system is to read the head pressure gauge with the product off and evaporator and condenser at the same temperature and then take the temperature on the condenser outlet tube. This temperature should be within 3° or 4° F. of what the Pressure-Temperature Relation chart shows for the given idle head pressure. If the temperature of the condenser outlet is considerably lower than the idle head pressure of the gauge this would indicate there is air in the system.

Thorough leak checking is necessary. Correct the source of the leak. Do not attempt to purge off the air because this could result in the system being undercharged. It is best to discharge, replace drier, evacuate and recharge with the specified refrigerant charge.

System Diagnosis

Symptoms of Low or High Ambient Temperature Installation

Lower ambient air temperature reduces the condensing temperature and therefore reduces the temperature of the liquid entering the evaporator. The increase in refrigeration effect due to operation in a lower ambient results in a decrease in power consumption and run time. At lower ambients there is a reduction in cabinet heat leak which is partially responsible for lower power consumption and run time.

An increase in refrigeration effect cannot be expected below a certain minimum ambient temperature. This temperature varies with the type and design of the product.

Generally speaking, ambient temperatures cannot be lower than 60° F. without affecting operating efficiency. Conversely, the higher the ambient temperature the higher the head pressure must be to raise the high side refrigerant temperature above that of the condensing medium. Therefore, head pressure will be higher as the ambient temperature raises. Refrigerators installed in ambient temperatures lower than 60° F. will not perform as well because the pressures within the system are generally reduced and unbalanced. This means that the lower head pressure forces less liquid refrigerant through the capillary line. The result is the symptoms of a refrigerant shortage. The lower the ambient temperature the more pronounced this condition becomes.

When a point where the ambient temperature is below the cut-in of the Temperature Control is reached, the compressor won't run.

The drain traps will freeze in ambient temperatures of 32° F.

Heat Load

A greater heat load can result from the addition of more than normal supply of foods, such as after doing the weekly shopping. Other items contributing to an additional heat load would be excessive door openings, poor door sealing, interior light remaining on, etc.

An increase in heat being absorbed by the refrigerant in the evaporator will affect the temperature and pressure of the gas returning to the compressor. Compartment temperatures, power consumption, discharge, and suction pressures are all affected by heat load.

Pressures will be higher than normal under heavy heat load.

Disassembly Procedures



WARNING

To avoid risk of electrical shock, personal injury, or death, disconnect electrical power source to unit, unless test procedures require power to be connected. Discharge capacitor through a resistor before attempting to service. Ensure all ground wires are connected before certifying unit as repaired and/or operational.

Door Removal

Fresh Food Door

1. Open both compartment doors. Remove door buckets, all shelving and drawers from refrigerator and freezer compartments. Place components on a padded surface to avoid damage.
2. Close both doors and tape them shut so they won't fall off unexpectedly when hinges are removed.

NOTE: To minimize possibility of personal injury and/or property damage, make sure unit doors are taped shut before you undertake the next steps:

3. On top of unit, remove screw and retain plastic cap from door hinge.
4. Remove and retain screws from top door hinge.
5. Pull tape off of door and lift door off unit. Set door on a padded surface to prevent damage to finish.
6. Remove and retain center hinge pin and all plastic shims. Note number and location of shims as you do so.

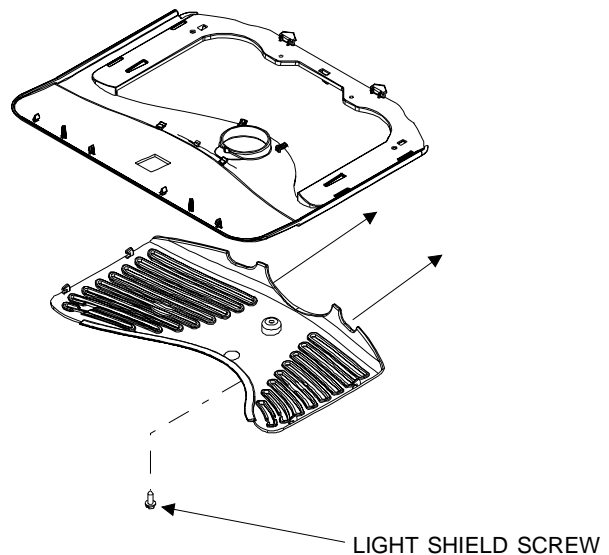

Freezer Door (some models)

1. Pull tape off freezer door and lift door off unit. Set door on a padded surface to prevent damage to finish.
2. If clearance requirements so dictate, remove center and lower door hinges:
 - a. Remove screws from center hinge bracket. Remove and retain bracket, screws, and all shims.
 - b. Remove toe grille by pulling it directly away from unit, and pop plastic cover off bottom door hinge. Grille and cover are fragile: keep both parts safe from harm.
 - c. Remove bottom hinge pin and all shims from bottom hinge bracket. Note number and location of shims. Retain all parts.
 - d. Loosen mounting screws from bottom hinge bracket. Remove and retain bracket and bolts.

Freezer Drawer (some models)

1. Open drawer to fully open position.
2. Remove upper and lower basket.
3. Remove screws one in each rail marked on side of rail.
4. Lift front of drawer up and out to remove drawer.
5. Set drawer on a padded surface to prevent damage to finish.

Refrigerator Compartment

Light Bulb

1. Loosen mounting screw from refrigerator light cover. Remove screw and slide cover to the rear to release it from holding tabs. Retain all parts.

Light Bulb Assembly

1. Loosen mounting screw from refrigerator light cover if equipped. Remove screw and slide cover to the rear to release it from holding tabs. Retain all parts.
2. Remove light bulbs.
3. Remove damper control cover and foam insert by pulling straight on sides of rear cover and tilt forward 1/2" to 1". This will release the cover from the tabs holding it in place.
4. Release tension on damper control belt by squeezing tabs on bottom of belt tensioner to release tensioner from its holding tabs.
5. Slip belt off of damper control cog.
6. Use a taped putty knife to carefully pry front edge of light assembly plastic housing. This releases tabs holding up front of housing.
7. When released disconnect connector plugged in to cabinet liner.

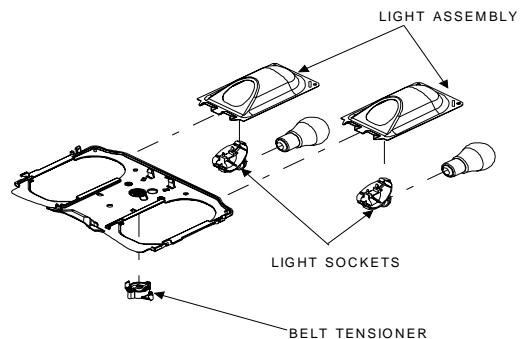

Disassembly Procedures



WARNING

To avoid risk of electrical shock, personal injury, or death, disconnect electrical power source to unit, unless test procedures require power to be connected. Discharge capacitor through a resistor before attempting to service. Ensure all ground wires are connected before certifying unit as repaired and/or operational.

Light Bulb Sockets

1. After following procedure on removing light bulb assembly.
2. Disconnect wires to sockets.
3. Squeeze tab on back side of socket to release it from assembly.
4. Reverse procedure to reassemble.

Defrost Timer (some models)

1. After following procedure on removing light bulb assembly.
2. Remove hex head screws holding timer to assembly.
3. Disconnect plug from timer.
4. Reverse procedure to reassemble.

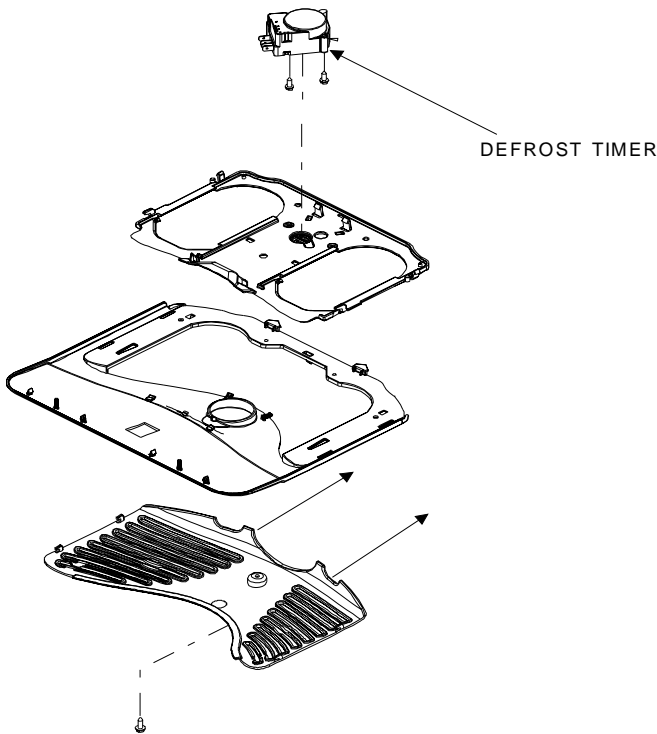

Mechanical Control Model

PC Control Board (some models)

1. Remove light shield by sliding shield to rear to release cover.
2. Depress with a screw driver through two slots in the front of the light housing release tabs to release Control Board housing.
3. Control Board housing will drop down exposing Control Board.
4. Unplug two wire harnesses plugged into the Control Board.

5. Release tabs holding Control Board to housing.

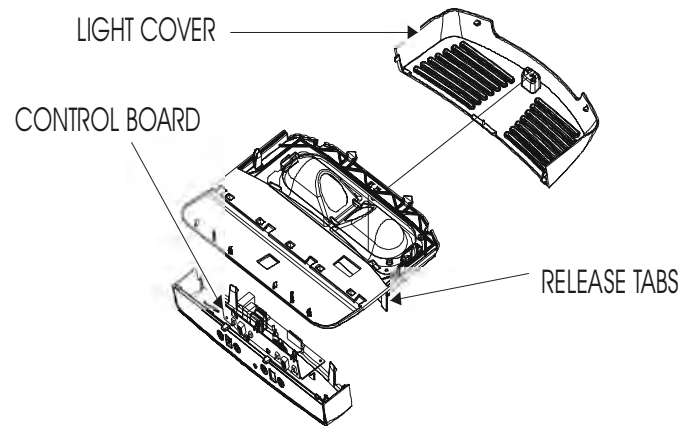

Mid Level Electronic Model

Light Switch

1. After following procedure on removing light bulb assembly.
2. Disconnect wires from light switch.
3. Squeeze tab to release light switch from light assembly.
4. Reverse procedure to reassemble.

Temp- Assure™ Damper Control (some models)

1. Remove light shield.
2. Remove damper control cover and foam insert by pulling straight on sides of rear cover and tilt forward 1/2" to 1". This will release the cover from the tabs holding it in place.
3. Release tension on damper control belt by squeezing tabs on bottom of belt tensioner to release tensioner from it's holding tabs.
4. Slip belt off of damper control cog.
5. Damper can be removed by pushing in tabs on left and right side of damper control to release damper from rear wall.
6. Reverse procedure to reassemble.

Disassembly Procedures



WARNING

To avoid risk of electrical shock, personal injury, or death, disconnect electrical power source to unit, unless test procedures require power to be connected. Discharge capacitor through a resistor before attempting to service. Ensure all ground wires are connected before certifying unit as repaired and/or operational.

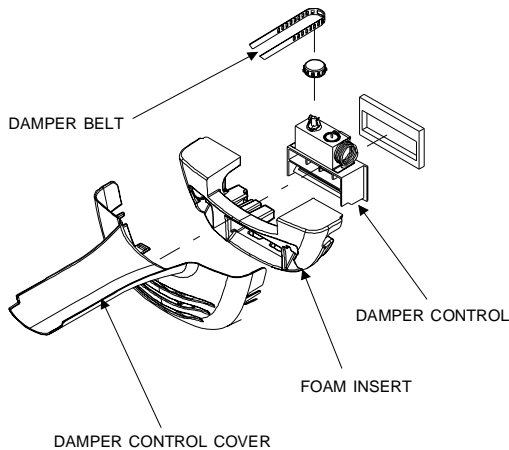

Electronic Temp-Assure™ Damper Control (some models)

1. Remove louvered cover off of Damper Control housing by squeezing down on louvers to release from housing.
2. Remove two screws holding housing to rear wall.
3. Remove Damper Control housing.
4. Remove Foam insert by pulling it out.
5. Unplug wire harness from Damper Control.
6. Unclip Damper Control from tabs and remove.

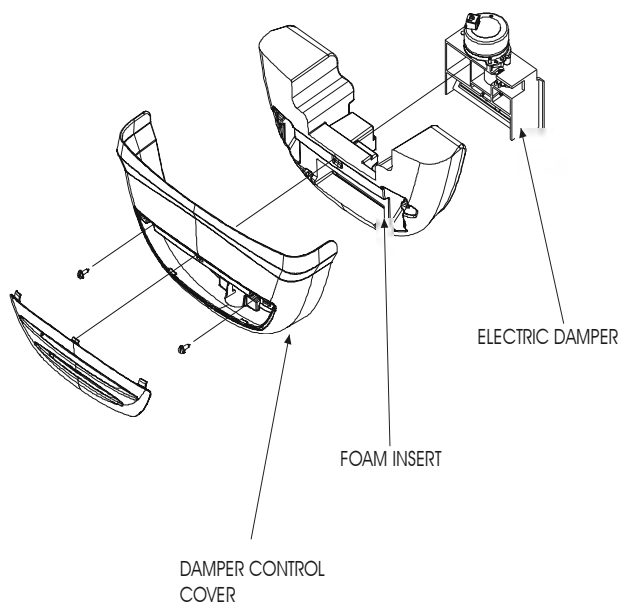

Fresh Food Thermistor (some models)

1. Remove light shield by sliding shield to rear to release cover.
2. Depress with a screw driver through two slots in the front of the light housing release tabs to release Control Board housing.
3. Control Board housing will drop down exposing Control Board and Thermistor.
4. Cut wires to Thermistor at Thermistor.
5. Remove Thermistor from clip.

Water Tank (some models)

1. Turn water off to unit.
2. Disconnect water line that supplies water tank from water valve.
3. Remove compression nut off of inlet to tank.
4. Remove crispers from fresh food compartment.
5. Disconnect compression nut from union on outlet of tank.
6. Remove two hex head screws holding tank to rear bulkhead.
7. Remove water tank and tubing.
8. Reverse procedure to reassemble.

Water Dispenser (some models)

1. Turn water off to unit.
2. Remove crispers from fresh food compartment.
3. Carefully pry top cover of dispenser out and remove.
4. Remove hex head screw to release dispenser from cabinet.
5. Disconnect compression nut from union at outlet of tank.
6. Remove compression nut from tubing.
7. Pull dispenser assembly and tube out of side wall.
8. Reverse procedure to reassemble.

Freezer Compartment

Freezer Temperature Control

1. Remove screw from rear edge of light shield.
2. Squeeze lens to release lens cover and remove.
3. With flat blade screwdriver release tabs in front of cold control knob.
4. Cold control assembly will drop down when released.
5. Remove Knob by pulling off shaft.
6. Disconnect wires from cold control.
7. Release cold control capillary from retainers.
8. Squeeze tab to release cold control from assembly.

Disassembly Procedures



WARNING

To avoid risk of electrical shock, personal injury, or death, disconnect electrical power source to unit, unless test procedures require power to be connected. Discharge capacitor through a resistor before attempting to service. Ensure all ground wires are connected before certifying unit as repaired and/or operational.

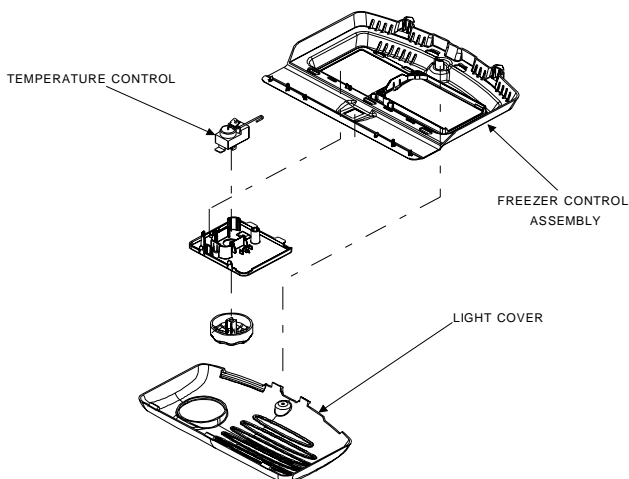

Freezer Thermistor (some models)

1. Remove Thermistor cover located on the Evaporator Cover by inserting a screw driver in slot and releasing tab holding Thermistor cover on.
2. Unclip Thermistor from cover and cut wires to Thermistor.
3. Remove Thermistor.

Light Socket

1. Remove screw from rear edge of light shield.
2. Squeeze lens to release lens cover and remove.
3. With flat blade screwdriver release tabs in front of cold control knob.
4. Cold control assembly will drop down when released.
5. Remove light bulb.
6. Squeeze tab holding light housing in place to release housing and remove.
7. Disconnect wires to socket.
8. Squeeze tab on back side of housing to release socket.

Light Switch

1. Carefully pry with taped putty knife pry the front of light bulb assembly to release tabs.
2. The whole light bulb assembly will drop down.
3. Disconnect wiring to light switch.
4. Squeeze tabs on back side of switch to release it from assembly.

Freezer Back Panel

NOTE: Freezer compartment should now be empty and walls should be clear of anything that will obstruct removal of back panel.

1. Loosen screws that mount icemaker to freezer compartment walls.
2. Pull icemaker gently away from wall of compartment. As you do so, work fill cup free of fill tube. Unplug icemaker electrical connector and remove icemaker from unit.
3. (Pull out Drawer only) Loosen and remove screws that hold 2 basket glides in place at left and right sides of compartment.
4. If unit has no icemaker pry with flatblade icemaker connection cover. Remove cover.
5. Remove hex head screws that hold back panel and remove panel.
6. Squeeze tabs on ice maker plug to release it from back panel

Evaporator Fan, Evaporator Motor

1. Follow instructions in removing freezer back panel.
2. Remove screws that anchor evaporator fan bracket to back wall of compartment. Pull fan and bracket out of place as a unit
3. Free fan bracket from wiring harness by disconnecting wires to motor and wire in clips that go to defrost terminator.
4. Pull evaporator fan blade off motor shaft.
5. Separate bracket and motor by squeezing lower retainer bracket to release motor from bracket.
6. When reinstalling motor reference position of terminals of new motor the same as old motor.

Defrost Terminator (Thermostat)

1. Terminator is fastened to evaporator tubing with a spring clip.
2. Snap terminator off tubing and cut wires to terminator.
3. Remove terminator from unit.

Defrost Heater

1. Follow instructions in removing freezer back panel.
2. Remove hex head screws retaining evaporator to back cabinet wall.
3. Disconnect plugs from both sides of heater.
4. Release connectors from air dams on each side of evaporator coil.
5. Grip evaporator tubing at left and right sides and tug evaporator sharply forward. Evaporator will pop out of plastic clips that hold it to back wall of unit. Then roll bottom of evaporator forward and up, exposing evaporator heater in its location amid fins at bottom of evaporator.

Disassembly Procedures



WARNING

To avoid risk of electrical shock, personal injury, or death, disconnect electrical power source to unit, unless test procedures require power to be connected. Discharge capacitor through a resistor before attempting to service. Ensure all ground wires are connected before certifying unit as repaired and/or operational.

6. Taking care to notice how and where they are placed, remove spring clips that hold heater into evaporator fins.
7. Pull evaporator heater out of evaporator fins, being careful that heater electrical leads do not snag on air dams, evaporator fins, tubing or other object.

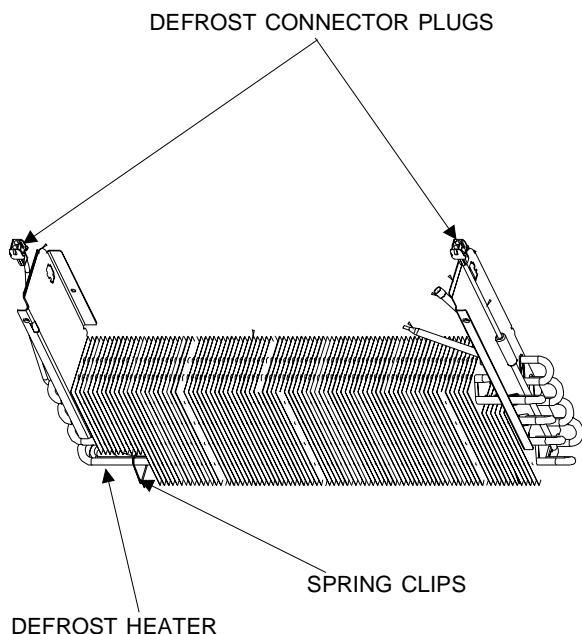

Evaporator Removal

NOTE: Reclaim refrigerant per instructions in "Service Procedures" before attempting evaporator removal. To avoid system contamination, do not leave system open for more than 10 minutes.

1. Follow instructions in removing freezer back panel.
2. Remove defrost thermostat. Refer to defrost thermostat removal.
3. Remove defrost heater. Refer to defrost heater removal.
4. Install protective cloth to prevent damage to cabinet liner
5. Unbraid suction copper fitting at evaporator.
6. Score and break copper capillary at evaporator.
7. Install new evaporator and reassemble taking care in not kinking tubing when reassembling.

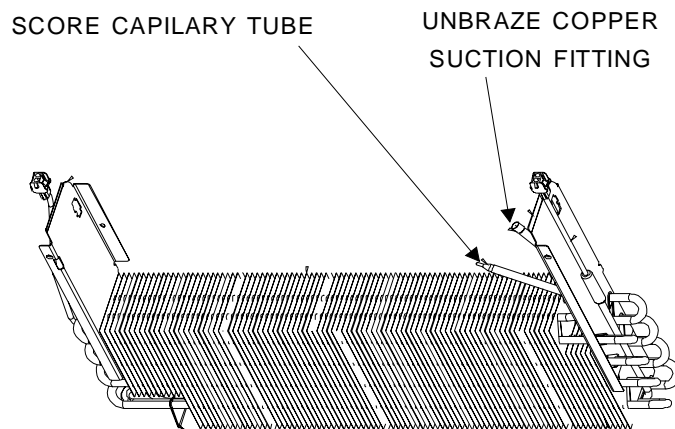

Drawer Assembly (some models)

1. Open drawer to fully open position.
2. Remove upper basket.
3. Remove screws one in each rail marked on side of rail.
4. Lift front of drawer up and out to remove drawer.

Drawer Rails

1. Remove screws inside plastic rail retainer.
2. Remove rails from retainer by depressing plastic tabs on back side of retainer.
3. Slide rails off of retainer.

Rack and Pinion Gear

1. Remove drawer assembly (see Drawer Assembly Removal).
2. Extend drawer rails to full open position, remove rails from retainer by depressing plastic tabs on back side of retainer.
3. Slide rails, rack and pinion gear off of retainer.
4. Reverse procedure to reassemble.

Note: When reinstalling rails, rack and pinion gear after latching rails in place, slide rails, rack and pinion to the fully closed position and then pull out to synchronize the rack and pinion gears.

Bottom of Cabinet

Front Roller Assembly

1. Remove toe grille by pulling it straight away from unit.
2. Raise front of refrigerator at least 4" off the deck and block it up.
3. Unscrew leveling bolt until wheel is free of leveling bolt.
4. Tip wheel assembly down until wheel assembly will slide out of mount from the rear of assembly.
5. Remove roller assembly from unit.

Disassembly Procedures



WARNING

To avoid risk of electrical shock, personal injury, or death, disconnect electrical power source to unit, unless test procedures require power to be connected. Discharge capacitor through a resistor before attempting to service. Ensure all ground wires are connected before certifying unit as repaired and/or operational.

Rear Roller Assembly

NOTE: Condensate drip pan may spill when steps 1 thru 4 are performed. Have a towel ready to mop up spillage.

1. Tape both doors shut to prevent doors from opening
2. Raise back of refrigerator at least 4" off the deck and block it up.
3. Remove machine-compartment cover.
4. Locate and slide roller pins out of rollers.
5. Install new rollers and reinstall pins.

Machine Compartment

Condenser Fan & Fan Motor

1. Remove machine compartment cover.
2. Unplug wiring harness connector from fan motor.
3. On backside of fan motor, screws secure the motor to its brackets. Remove those screws.
4. Note which side of fan blade is "front" and which side is "rear." Then use pliers to loosen nut that secures fan blade to motor shaft. Remove nut and fan blade.

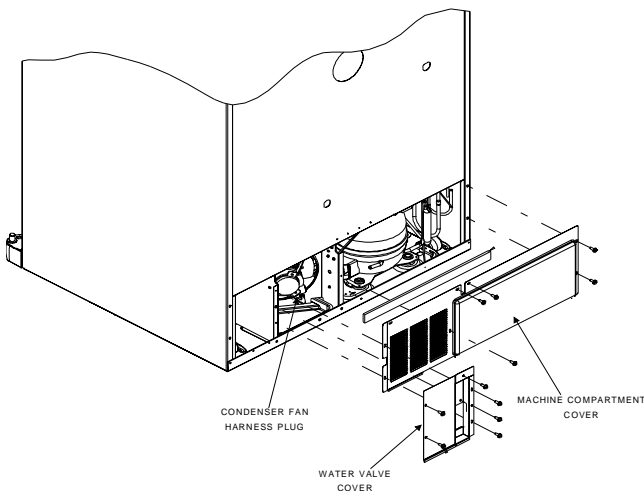

Compressor

NOTE: Install new drier and compressor per instructions in "Service Procedures." Evacuate and recharge sealed system per instructions in "Service Procedures."

1. Remove machine compartment cover.
2. Remove drier.
3. Disconnect all compressor wiring and overload/relay assembly.

4. Unbrazed low and high pressure lines at compressor.
5. Remove compressor mounting bolts.
6. Lift compressor out of unit.

Overload/Relay/Capacitor

1. Remove machine compartment cover.
2. Using fingers and standard screwdriver, press and pry bale strap off the overload/relay assembly
3. Disconnect wires from overload/relay assembly. Reference wire location.
4. Unplug overload/relay assembly from compressor.

Condensate Drain Pan

NOTE: Condensate drip pan may spill when steps 1 thru 4 are performed. Have a towel ready to mop up spillage.

1. Remove machine compartment cover.
2. Tape both doors shut to prevent doors from opening
3. Raise back of refrigerator at least 4" off the deck and block it up.
4. Remove Rear torx head screws holding base pan and loosen front torx head screws on bottom of cabinet.
5. Carefully lower basepan taking care not to kink tubing to compressor or condenser.
6. Remove hex screws holding condenser fan shroud to basepan.
7. Lift shroud up and out of the way to allow removal of condensate drain pan.
8. Remove drain pan.

Condensate Drain Tube

1. Remove machine compartment cover.
2. Drip tube is mounted to bottom of cabinet with clip. Reach into machine compartment and squeeze the clip to release drain tube.
3. Pull drip tube down, off drain nipple and back, out of unit.

Condenser Removal

NOTE: Install new drier per instructions in "Service Procedures." Evacuate and recharge sealed system per instructions in "Service Procedures."

1. Remove machine compartment covers.
2. Unbrazed tubing going to PC loop and heat exchanger.
3. Disconnect all machine compartment wiring at molex plug to cabinet.
4. Tape both doors shut to prevent doors from opening
5. Raise back of refrigerator at least 6" off the deck and block it up.
6. Remove torx head screws to drop base pan and condenser out of unit.
7. Remove basepan and condenser out of unit.
8. Unbrazed discharge and condenser out at condenser.
9. Unsnap condenser from basepan and replace.

Control Board (Mid Level)



WARNING

To avoid risk of electrical shock, personal injury, or death, disconnect electrical power source to unit, unless test procedures require power to be connected. Discharge capacitor through a 10,000 ohm resistor before attempting to service. Ensure all ground wires are connected before certifying unit as repaired and/or operational.

Programming Mode:

Note: The Program Code is located on the Serial Plate on this unit after the word Code.

1. Open the Fresh Food door and hold the Fresh Food door light switch closed while pushing the Freezer Temperature Down  Key pad 3 times consecutively.

Note: The 3 Keystrokes must be done consecutively and within 10 seconds.

2. Release the Fresh Food door light switch.
3. The control will display PE to confirm entry into the programming mode.

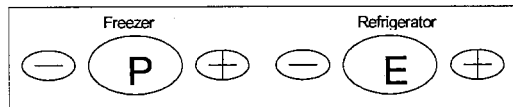

4. Entry is confirmed by pressing the Freezer Down key once more.

Note: All control functions will be turned off (Compressor, Defrost, Evaporator Fan, the damper will remain in its current position)

5. The control will display the current Program Code. This value should be validated with the Program Code printed on the unit serial plate.

Note: If the Program Code is correct, the Programming Mode is exited by closing the Refrigerator door(s).

6. To set the desired Program Code number press the Freezer and Refrigerator UP keys. The corresponding digit will be advanced with each key press.
7. Once the desired Program Code is displayed, press the Freezer DOWN Key until the Program Code begins flashing indicating it has been saved.

Note: If you attempt to enter an invalid Program Code the control will not save the new code, but will flash the old code and this will be displayed. (The unit will NOT run with a Program Code of 00).

8. Once the Program Code has been saved the Programming Mode is exited by closing the Refrigerator door(s). If the new code is incorrect this process should be repeated after closing the

Refrigerator door(s).

The Programming mode can be exited at any time by closing the Refrigerator Door(s).

Defrost Operation:

The Control Board adapts the compressor run time between defrosts to achieve optimum defrost intervals by monitoring the length of time the defrost heater is on.

After initial power up, defrost interval is 4 hours compressor run time. Defrost occurs immediately after the 4 hours.

Note: Once unit is ready to defrost there is a 4 minute wait time prior to the beginning of the defrost cycle.

Forced Defrost Mode:

The forced defrost function is performed using the refrigerator display and keypad. Enter the Forced Defrost Mode by performing the following sequence of events:

1. Hold the refrigerator door light switch closed.
2. Press the Refrigerator Temperature Down  keypad 3 times consecutively.

Note: The 3 keystrokes must be consecutive and within 10 seconds.

3. Release the refrigerator door light switch.
4. The control will display Fd to confirm entry into the Forced Defrost Mode.

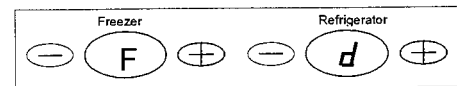

5. Entry is confirmed by pressing the Refrigerator Down  key once more. The unit is off and in the Defrost Mode.

Note: All control functions will be turned off (Compressor, Defrost, Evaporator Fan, the damper will remain in its current position).

Control Board (Mid Level)

⚠ WARNING

To avoid risk of electrical shock, personal injury, or death, disconnect electrical power source to unit, unless test procedures require power to be connected. Discharge capacitor through a 10,000 ohm resistor before attempting to service. Ensure all ground wires are connected before certifying unit as repaired and/or operational.

6. The control will default to the short run period test as shown here:

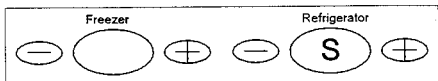

Note: You can toggle between the (S)hort and (L)ong test mode by pressing the Refrigerator UP Key. Long Test mode is used for factory test and should not be used in the field.

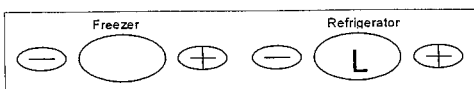

7. Once the desired mode is displayed, confirm the forced defrost by pressing the Refrigerator down Key once. The defrost will begin immediately and the display will return to a normal operating display with set point values.
8. Close the Refrigerator door(s). You are in the defrost mode.

Note: Forced Defrost mode can be exited at any time prior to step 7 by closing the Refrigerator Door(s).

Service Test Mode:

The service test functions are performed using the refrigerator display and keypad. Enter the Service Test Mode by performing the following sequence of events:

1. Hold the refrigerator door light switch closed.
2. Press the Refrigerator Temperature Up keypad 3 times consecutively.

Note: The 3 Keystrokes must be done consecutively and within 10 seconds.

3. Release the refrigerator door light switch.
4. The control will display SE to confirm entry into the service mode.

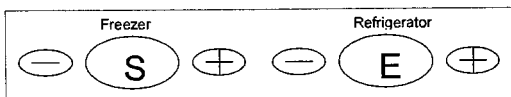

5. Entry to the Service Menu is confirmed by pressing the Refrigerator Up key once more.
6. The control will display its software version for 3 seconds.

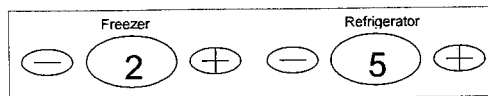

7. Following the software revision display the freezer display will read the first test number in the diagnostic tree. The refrigerator display will be blank.

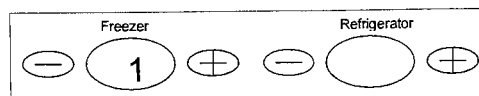

Note: All control functions will be turned off (Compressor, Defrost, Evaporator Fan, the damper will remain in its current position).

8. You are now in the SERVICES TEST operational mode and may use the diagnostic tests. **The Service Test Mode can be exited at any time by closing the Refrigerator Door(s).**

Service Test 1 – Defrost Thermostat & Defrost Circuit Test

When selected this test will display the state of the defrost thermostat. In order to perform this test the defrost heater will be energized. The test is activated and deactivated using the Refrigerator Up key. Once activated, this test must be de-activated to move to another test number. The Freezer Up / Down keys allow selection of the test to be performed. This test also allows observation and measurement of proper defrost function. You can observe defrost heat and voltages while the test is activated.

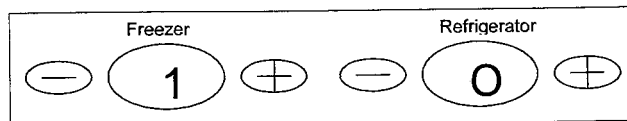

DEFROST THERMOSTAT OPEN

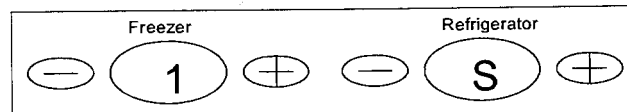

DEFROST THERMOSTAT SHORTED (CLOSED)

Control Board (Mid Level)



WARNING

To avoid risk of electrical shock, personal injury, or death, disconnect electrical power source to unit, unless test procedures require power to be connected. Discharge capacitor through a 10,000 ohm resistor before attempting to service. Ensure all ground wires are connected before certifying unit as repaired and/or operational.

Service Test 2 – Compressor/Condenser Fan Test

When selected and activated this test will operate the Compressor/Condenser Fan circuit. You should evaluate proper operation of the compressor and condenser fan. The Refrigerator Up  key will toggle between “O” / “F” (ON & OFF) the compressor drive circuit. The test must be “deactivated” or in the OFF position to move to another test selection.

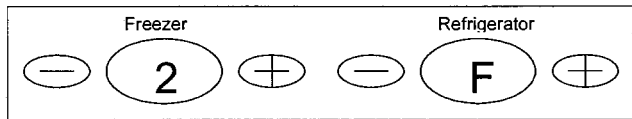
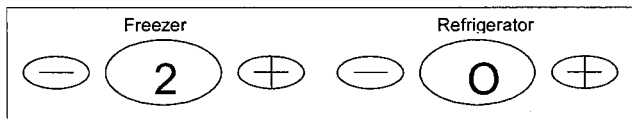

OBSERVE COMPRESSOR & CONDENSER FAN FUNCTION

Service Test 3 – Evaporator/Freezer Fan Test

When selected and activated this test will operate the freezer fan. The Refrigerator Up  key will toggle between “O” / “F” (ON & OFF) the fan drive circuit. You will have to inspect the fan for proper function. The test must be “deactivated” or in the OFF position to move to another test selection.

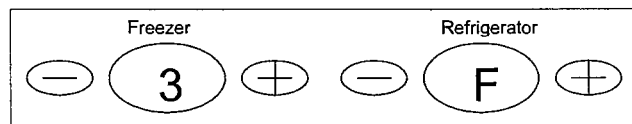
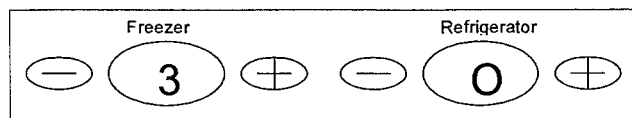

OBSERVE FAN OPERATION

Service Test 4 – Fresh Food Thermistor Test

When selected and activated this test will display Pass, Open, Short result for a test on the Fresh Food Thermistor circuit as show below. The test is

activated and de-activated via the Refrigerator Up  key, and must be de-activated to move to another test selection.

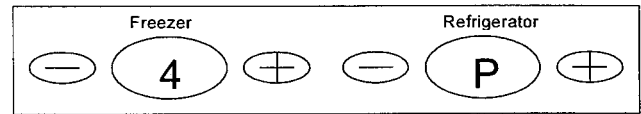

PASS RESULT

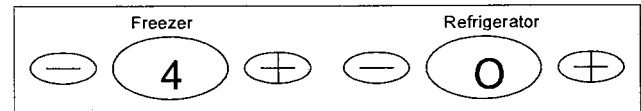

OPEN RESULT

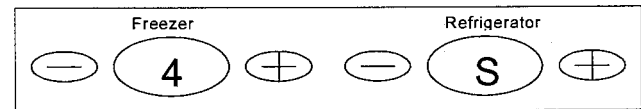

SHORT RESULT

Service Test 5 – Freezer Thermistor Test

When selected this test will display Pass, Open, Short result for a test on the Freezer Thermistor circuit as show below. The test is activated and de-activated via the Refrigerator Up  key, and must be de-activated to move to another test selection.

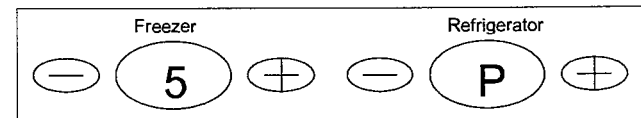

PASS RESULT

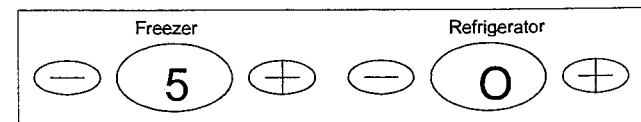

OPEN RESULT

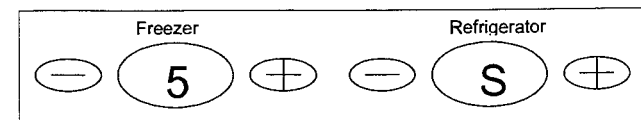

SHORT RESULT

Control Board (Mid Level)

⚠ WARNING

To avoid risk of electrical shock, personal injury, or death, disconnect electrical power source to unit, unless test procedures require power to be connected. Discharge capacitor through a 10,000 ohm resistor before attempting to service. Ensure all ground wires are connected before certifying unit as repaired and/or operational.

Service Test 6 – Open Damper Test

When selected this test will indicate the current position "O" / "C" (OPEN / CLOSED) of the refrigerator damper. The Refrigerator Up \oplus key will toggle the damper open and closed. You must allow 1 minute for each attempt to change the damper position. You should observe proper damper function.

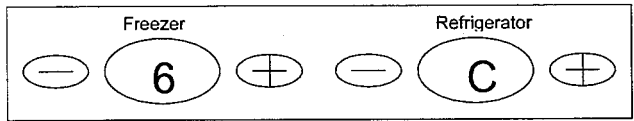
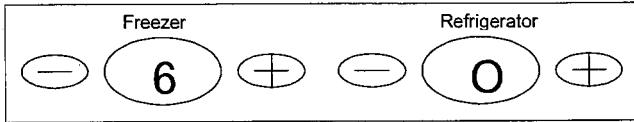

OBSERVE DAMPER FUNCTION

⚠ CAUTION

Adjustments of Service Test 7 or Service Test 8 will alter the performance of the unit.

Service Test 7 – FF Performance Adjustment

This test will allow adjustment of the control performance points. Each step will incrementally change the Refrigerator performance warmer 1° (towards 1) or colder 1° towards (9) as adjusted. The default value is 5. The refrigerator \oplus / \ominus Up/Down keys are used to adjust the Performance Offset value.

WARMER \leftarrow (1 2 3 4 (5) 6 7 8 9) \rightarrow COLDER.

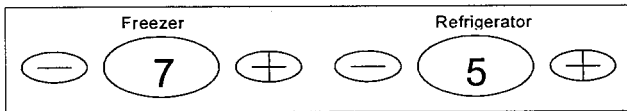

DEFAULT

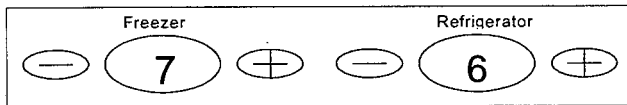

COLDER

The last FF Performance Offset value displayed before leaving test 7 will be saved when the refrigerator door(s) is closed.

Service Test 8 – FZ Performance Adjustment

This test will allow the adjustment of the control performance points. Each step will incrementally change the Freezer performance warmer 1° (towards 1) or colder 1° towards (9) as adjusted. The default value is 5. The refrigerator \oplus / \ominus Up/Down keys are used to adjust the Performance Offset value.

WARMER \leftarrow (1 2 3 4 (5) 6 7 8 9) \rightarrow COLDER

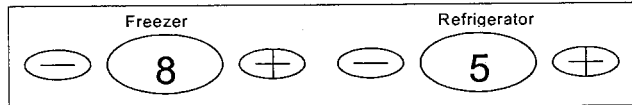

DEFAULT

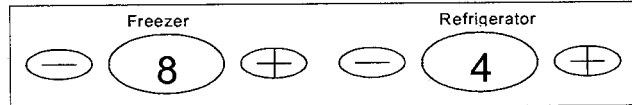

WARMER

The last FZ Performance Offset value displayed before leaving test 8 will be saved when the refrigerator door(s) is closed.

Control Board (Mid Level)

⚠ WARNING

To avoid risk of electrical shock, personal injury, or death, disconnect electrical power source to unit, unless test procedures require power to be connected. Discharge capacitor through a 10,000 ohm resistor before attempting to service. Ensure all ground wires are connected before certifying unit as repaired and/or operational.

Show-Room Mode

A manual method to put the electronic control in a "Show-Room" mode has been provided. In this mode the control display and keypad will operate normally, but all of the cooling and air moving devices will remain off. The unit will remain in Show-Room mode until power is removed.

Entering Show-Room Mode

The Show-Room mode is set using the refrigerator display and keypad. Enter the Show-room Mode by performing the following sequence of events:

1. Hold the refrigerator door light switch closed.
2. Press the Freezer Temperature UP \oplus keypad 3 times consecutively.
 - a. The 3 keystrokes must be consecutive and within 10 seconds.
3. Release the refrigerator door light switch.
4. The control will display SH allowing the technician to confirm entry into the Show-Room Mode. Entry is confirmed by pressing the Freezer UP key once more.

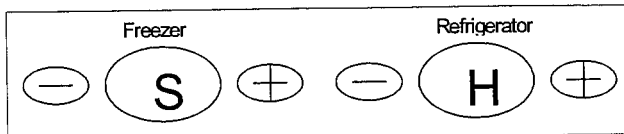

5. Once the Show-Room mode is confirmed, the display will return to a normal operating display with set point values.

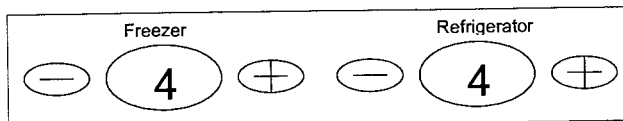

Thermistor Resistance Chart

°F TEMPERATURE	NOMINAL OHMS RESISTANCE
70	119430
60	157133
50	199016
40	266820
30	343535
20	445849
10	616353
0	815074
-5	968073
-10	1153669

Control Board (Fully Electronic)





WARNING

To avoid risk of electrical shock, personal injury, or death, disconnect electrical power source to unit, unless test procedures require power to be connected. Discharge capacitor through a 10,000 ohm resistor before attempting to service. Ensure all ground wires are connected before certifying unit as repaired and/or operational.

Programming Mode:

NOTE: The Program Code is located on the Serial Plate on this unit after the word Code.

1. Press and hold the Door Alarm Keypad .
2. Press and hold Freezer Temperature Down Keypad .
3. Release the Door Alarm Keypad and wait 3 seconds.
4. The control will display PE to indicate the programming mode.
5. Entry is confirmed by pressing the Freezer Temperature Down Keypad once more.
6. The control will display the current Program CODE. This value should be validated with the Program CODE printed on the unit serial plate.

NOTE: If the Program CODE is correct, the Programming Mode is exited by closing the Refrigerator door(s).

7. Press the Refrigerator Temperature UP Keypad or Refrigerator Down Keypad to change the digit value with each key press.
8. The decimal point indicates the selected digit. Press the Freezer Temperature UP Keypad to select the next digit.
9. Once the desired Program CODE is entered, press and hold the Freezer Temperature DOWN Keypad until the Program CODE begins flashing indicating it has been saved.

NOTE: If you attempt to enter an invalid Program CODE the control will not save the new code, but will beep. (The unit will NOT run with a Program CODE of 0000). Once the Program CODE has been saved the Programming Mode is exited by closing the Refrigerator door(s). If the new code is incorrect this process should be repeated after closing the Refrigerator door(s).



The Programming mode can be exited at any time by closing the Refrigerator Door(s) or will exit if unattended for four minutes.

Defrost Operation:

The Control Board adapts the compressor run time between defrosts to achieve optimum defrost intervals by monitoring the length of time the defrost heater is on. After initial power up, defrost interval is 4 hours compressor run time. Defrost occurs immediately after the 4 hours.



Forced Defrost Mode:

Enter the Forced Defrost Mode by performing the following sequence of events:

1. Press and hold the Door Alarm Keypad .
2. Press and hold Refrigerator Temperature Down Keypad .
3. Release the Door Alarm Keypad and wait 3 seconds. Fd appears in left display
4. Press the Refrigerator Down Keypad again. Sh appears in right display.
5. Press again to force defrost Fd and Sh will flash in display indicating unit is in defrost.

Service Test Mode:

The service test functions are performed using the refrigerator display and keypad. Enter the Service Test Mode by performing the following sequence of events.

1. Open the Fresh Food door and press and hold the Door Alarm Keypad .
2. Press and hold Refrigerator Temperature UP Keypad .
3. Release the Door Alarm Keypad and wait 3 seconds. SE appears in the left display
4. Press the Refrigerator UP Keypad again.
5. Display will show 001 in left display and numeric or dashes in right display. Test # 001 is for Factory Use Only.
6. Press Freezer Up Keypad and Freezer Down

Control Board (Fully Electronic)





WARNING

To avoid risk of electrical shock, personal injury, or death, disconnect electrical power source to unit, unless test procedures require power to be connected. Discharge capacitor through a 10,000 ohm resistor before attempting to service. Ensure all ground wires are connected before certifying unit as repaired and/or operational.

Programming Mode:

NOTE: The Program Code is located on the Serial Plate on this unit after the word Code.

1. Press and hold the Door Alarm Keypad .
2. Press and hold Freezer Temperature Down Keypad .
3. Release the Door Alarm Keypad and wait 3 seconds.
4. The control will display PE to indicate the programming mode.
5. Entry is confirmed by pressing the Freezer Temperature Down Keypad once more.
6. The control will display the current Program CODE. This value should be validated with the Program CODE printed on the unit serial plate.

NOTE: If the Program CODE is correct, the Programming Mode is exited by closing the Refrigerator door(s).

7. Press the Refrigerator Temperature UP Keypad or Refrigerator Down Keypad to change the digit value with each key press.
8. The decimal point indicates the selected digit. Press the Freezer Temperature UP Keypad to select the next digit.
9. Once the desired Program CODE is entered, press and hold the Freezer Temperature DOWN Keypad until the Program CODE begins flashing indicating it has been saved.

NOTE: If you attempt to enter an invalid Program CODE the control will not save the new code, but will beep. (The unit will NOT run with a Program CODE of 0000). Once the Program CODE has been saved the Programming Mode is exited by closing the Refrigerator door(s). If the new code is incorrect this process should be repeated after closing the Refrigerator door(s).



The Programming mode can be exited at any time by closing the Refrigerator Door(s) or will exit if unattended for four minutes.

Defrost Operation:

The Control Board adapts the compressor run time between defrosts to achieve optimum defrost intervals by monitoring the length of time the defrost heater is on. After initial power up, defrost interval is 4 hours compressor run time. Defrost occurs immediately after the 4 hours.



Forced Defrost Mode:

Enter the Forced Defrost Mode by performing the following sequence of events:

1. Press and hold the Door Alarm Keypad .
2. Press and hold Refrigerator Temperature Down Keypad .
3. Release the Door Alarm Keypad and wait 3 seconds. Fd appears in left display.
4. Press the Refrigerator Down Keypad again. Sh appears in right display.
5. Press again to force defrost Fd and Sh will flash in display indicating unit is in defrost.

Service Test Mode:

The service test functions are performed using the refrigerator display and keypad. Enter the Service Test Mode by performing the following sequence of events.

1. Open the Fresh Food door and press and hold the Door Alarm Keypad .
2. Press and hold Refrigerator Temperature UP Keypad .
3. Release the Door Alarm Keypad and wait 3 seconds. SE appears in the left display.
4. Press the Refrigerator UP Keypad again.
5. Display will show 001 in left display and numeric or dashes in right display. Test # 001 is for Factory Use Only.
6. Press Freezer Up Keypad and Freezer Down

Control Board (Fully Electronic)





WARNING

To avoid risk of electrical shock, personal injury, or death, disconnect electrical power source to unit, unless test procedures require power to be connected. Discharge capacitor through a 10,000 ohm resistor before attempting to service. Ensure all ground wires are connected before certifying unit as repaired and/or operational.



Keypad to toggle through Service Test numbers.

opening.



Service Test – 101 Defrost Heater & Defrost Circuit

- Press the Refrigerator Up keypad  and Refrigerator Down keypad  to energize or de-energize the Defrost circuit. The display will read OFF when de-energized OP when energized with open defrost thermostat and CL when energized with closed defrost thermostat.

Service Test – 102 Compressor / Condenser Fan



- Press the Refrigerator Up keypad  and Refrigerator Down keypad  to toggle Compressor/Condenser fan On and Off.

Service Test – 111 Fresh Food Fan (if equipped)

- Press the Refrigerator Up Keypad  and Refrigerator Down Keypad  to toggle Fresh Food Fan On and Off.

NOTE: Display will show state OFF or DC voltage.

Service Test – 112 Freezer Fan

- Press the Refrigerator Up keypad  and Refrigerator Down keypad  to toggle Freezer Fan On and Off.



NOTE: Display will show DC voltage.

Service Test – 121 Damper Operation

- Press the Refrigerator Up keypad and Down keypad to toggle Damper (OP) open and (CL) closed.

NOTE: If damper is opening or closing it will not allow you to toggle damper and beep. Display will show state -CL or -OP if Damper is in the process of closing or

Service Test – 131 Mullion Heater 3 Door Models

- Press the Refrigerator Up keypad  and Refrigerator Down keypad  to toggle Mullion Heater On and Off.

Service Test – 141 Fresh Food Thermistor

- Will Show Fresh Food Temperature or OP for open thermistor or SH for shorted thermistor.

Service Test – 142 Freezer Thermistor

- Will Show Freezer Temperature or OP for open thermistor or SH for shorted thermistor.

Service Test – 143 Machine Compartment Thermistor

- Will Show Machine Compartment Temperature or, OP open thermistor or SH shorted thermistor.

Service Test – 151 Fresh Food Door State

- Will show state of Fresh Food Door. OP (open) CL (closed).

NOTE: By pushing fresh food door switch you can toggle state from OP (open) to CL (closed).

Service Test – 152 Freezer Door State

- Will show state of Freezer Door. OP (open) CL (closed).

NOTE: By pushing freezer door switch you can toggle state from OP (open) to CL (closed).

Service Test – 174 Water Actuator BM Internal Dispenser

- Display shows the state of the Internal Dispenser (ON or OFF).



Control Board (Fully Electronic)



WARNING

To avoid risk of electrical shock, personal injury, or death, disconnect electrical power source to unit, unless test procedures require power to be connected. Discharge capacitor through a 10,000 ohm resistor before attempting to service. Ensure all ground wires are connected before certifying unit as repaired and/or operational.

NOTE: By pushing Actuator pad you can change state of Internal Dispenser

Press the Refrigerator Up keypad  and Refrigerator Down keypad  to adjust temperature setpoints + 6 to - 6

Service Test – 181 Keypad Operation

- Display shows a numeric or letter display indicating the last key pressed.

NOTE: Refrigerator Up/Down keypads have no effect when pressed and Freezer Up/Down keypads remain operational.



Service Test – 182 LED Indicator Operation

- Press the Refrigerator Up Keypad  to show operation of LED Indicators. All LED Indicators will flash. Press twice and LED will stop flashing.



Service Test – 191 Ice Maker Water Valve

- Display shows the state of the Ice Maker Water Valve (ON or OFF).



Service Test – 201 Mullion Heater 100% Operation (if equipped)

Press the Refrigerator Up keypad  and Refrigerator Down keypad  to toggle Mullion Heater On and Off.

Service Test – 202 Defrost Operation

Press the Refrigerator Up keypad  and Refrigerator Down keypad  to toggle Defrost Operation to minimum time between defrosts On and Off.

Service Test – 211 Fresh Food Temperature Adjustment

Press the Refrigerator Up keypad  and Refrigerator Down keypad  to adjust temperature setpoints + 6 to - 6

Service Test – 212 Freezer Temperature Adjustment

Service Test – 221 Default Settings Reset

Press the Refrigerator Up keypad  to activate.

Service Test – 231 Water Filter Volume % Consumed

Display shows Volume % consumed since installed.

Service Test – 232 Water Filter Time Life

Display shows days filter used since installed.

Service Test – 241 Software Revision Main Control

Display shows Software Revision Main Control.

Service Test – 242 Software Revision Main Display

Display shows Software Revision Main Display.

Service Test – 243 Software Revision Dispenser

Display shows Software Revision Dispenser.

Control Board (Fully Electronic)



WARNING

To avoid risk of electrical shock, personal injury, or death, disconnect electrical power source to unit, unless test procedures require power to be connected. Discharge capacitor through a 10,000 ohm resistor before attempting to service. Ensure all ground wires are connected before certifying unit as repaired and/or operational.





NOTE: Service Tests 300-499 require support from Technical Support center. Service Tests 500-599 are for Factory Use Only.

Show Room Mode:

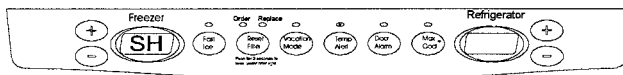
Enter the Show Room Mode by performing the following sequence of events:



1. Open the Fresh Food door and press and hold the Door Alarm Keypad .
2. Press and hold Freezer Temperature Up Keypad .
3. Release the Door Alarm Keypad and wait 3 seconds. SH appears in left display





4. Press the Freezer Temperature Up Keypad  again. On or Off appears in right display.
 5. Press the Refrigerator Up Keypad  and Refrigerator Down Keypad  toggle Showroom feature On or Off.
- NOTE:** Showroom will always off when the first powered.
6. Press the Freezer Temperature Up Keypad  to confirm setting. The display will flash the selected setting.

Sabbath Mode:





The Sabbath mode is performed using the Freezer display and Refrigerator keypad. Enter the Sabbath Mode by performing the following sequence of events:

1. Open the Fresh Food door and press and hold the Door Alarm Keypad  for 6 seconds .
2. Press Freezer Temperature Up Keypad  until SAb is in the Freezer display .

3. Press the Refrigerator Up Keypad  or Down Keypad  to toggle between On and OFF in the Refrigerator display.
4. Selection activates immediately.





Fahrenheit or Celsius Mode:

The Fahrenheit or Celsius mode is performed using the Freezer display and Refrigerator keypad. Enter the Fahrenheit or Celsius Mode by performing the following sequence of events:

1. Open the Fresh Food door and press and hold the Door Alarm Keypad  for 6 seconds .
2. Press Freezer Temperature Up Keypad  until F_C is in the Freezer display .
3. Press the Refrigerator Up Keypad  or Down Keypad  to toggle between °F and °C in the Refrigerator display.
4. Close door or toggle door switch to activate selection.

Alarm Enable Mode:

The Door Alarm Mode is performed using the Freezer display and Refrigerator keypad. Enter the Alarm Enable Mode by performing the following sequence of events:

1. Open the Fresh Food door and press and hold the Door Alarm Keypad  for 6 seconds .
2. Press Freezer Temperature Up Keypad  until AL is in the Freezer display .
3. Press the Refrigerator Up Keypad  or Down Keypad  to toggle between On and OFF in the Refrigerator display.
4. Close door or toggle door switch to activate.

Appendix A



Refrigerator

Use & Care Guide

Table of Contents

	Important Safety Instructions 1-2		Water Filter17-18
	Installation 3-9		Food Storage Tips 19-21
	Temperature Controls 10-12		Care and Cleaning 22-25
	Fresh Food Features 13-15		Operating Sounds 26
	Freezer Features 15		Troubleshooting 27-29
	Ice And Water16		Warranty & Service 31



Important Safety Instructions

Installer: Please leave this guide with this appliance.

Consumer: Please read and keep this Use & Care Guide for future reference, it provides the proper use and maintenance information.

Keep sales receipt and/or cancelled check as proof of purchase.

Call: 1-800-688-9900 U.S.A.
1-866-688-2002 Canada

Have complete model and serial number identification of your refrigerator. This is located on a data plate inside the refrigerator compartment, on the upper left side. Record these numbers below for easy access.

Model Number _____

Serial Number _____

Date of Purchase _____

In our continuing effort to improve the quality and performance of our appliances, it may be necessary to make changes to the appliance without revising this guide.

What You Need to Know About Safety Instructions

Warning and Important Safety Instructions appearing in this guide are not meant to cover all possible conditions and situations that may occur. Common sense, caution and care must be exercised when installing, maintaining or operating appliance.

Always contact your dealer, distributor, service agent or manufacturer about problems or conditions you do not understand.

Recognize Safety Symbols, Words, Labels

DANGER

DANGER – Immediate hazards which **WILL** result in severe personal injury or death.

WARNING

WARNING – Hazards or unsafe practices which **COULD** result in severe personal injury or death.

CAUTION

CAUTION – Hazards or unsafe practices which **COULD** result in minor personal injury or property damage.

DANGER

To reduce risk of injury or death, follow basic precautions, including the following:

IMPORTANT: Child entrapment and suffocation are not problems of the past. Junked or abandoned refrigerators are still dangerous – even if they sit out for “just a few days.” If you are getting rid of your old refrigerator, please follow the instructions below to help prevent accidents.

Before you throw away your old refrigerator or freezer:

- Take off the doors.
- Leave the shelves in place so children may not easily climb inside.

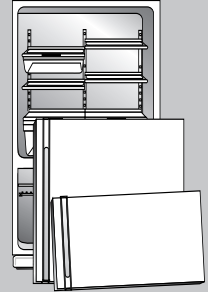

This appliance is equipped with a three-prong grounding plug for your protection against possible electrical shock hazards. It must be plugged into a grounding receptacle. Where a standard two-prong wall receptacle is encountered, it is the personal responsibility and obligation of the customer to have it replaced with a properly grounded three-prong wall receptacle. Do not under any circumstances, cut or remove the third (ground) prong from the power cord. Do not use an adapter plug.

Power supply cord with three-prong grounding plug

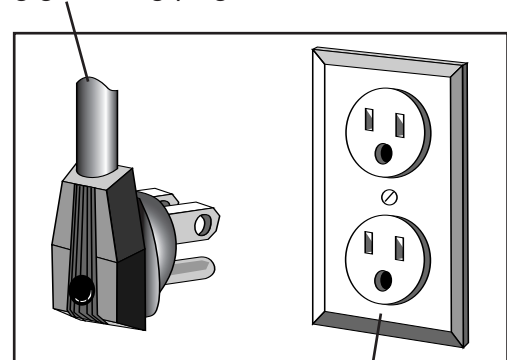

Grounding type wall receptacle



Important Safety Instructions

⚠ WARNING

To reduce risk of fire, electric shock, serious injury or death when using your refrigerator, follow these basic precautions, including the following:

1. Read all instructions before using the refrigerator.
2. Observe all local codes and ordinances.
3. Be sure to follow grounding instructions.
4. Check with a qualified electrician if you are not sure this appliance is properly grounded.
5. Do not ground to a gas line.
6. Do not ground to a cold-water pipe.
7. Refrigerator is designed to operate on a separate 115 volt, 15 amp., 60 cycle line.
8. Do not modify plug on power cord. If plug does not fit electrical outlet, have proper outlet installed by a qualified electrician.
9. Do not use a two-prong adapter, extension cord or power strip.
10. Do not remove warning tag from power cord.
11. Do not tamper with refrigerator controls.
12. Do not service or replace any part of refrigerator unless specifically recommended in Use & Care Guide or published user-repair instructions. Do not attempt service if instructions are not understood or if they are beyond personal skill level.
13. Always disconnect refrigerator from electrical supply before attempting any service. Disconnect power cord by grasping the plug, not the cord.
14. Install refrigerator according to Installation Instructions. All connections for water, electrical power and grounding must comply with local codes and be made by licensed personnel when required.
15. Keep your refrigerator in good condition. Bumping or dropping refrigerator can damage refrigerator or cause refrigerator to malfunction or leak. If damage occurs, have refrigerator checked by qualified service technician.
16. Replace worn power cords and/or loose plugs.
17. Always read and follow manufacturer's storage and ideal environment instructions for items being stored in refrigerator.
18. Your refrigerator should not be operated in the presence of explosive fumes.
19. Children should not climb, hang or stand on any part of the refrigerator.
20. Clean up spills or water leakage associated with water installation.

SAVE THESE INSTRUCTIONS



Installation

Your refrigerator was packed carefully for shipment. Remove and discard shelf packaging and tape. Do not remove the serial plate.

Location

- Do not install refrigerator near oven, radiator or other heat source. If not possible, shield refrigerator with cabinet material.
- Do not install where temperature falls below 55° F (13° C) or rises above 110° F (43° C). Malfunction may occur at this temperature.
- **Refrigerator is designed for indoor household application only.**

Measuring the Opening

When installing your refrigerator, measure carefully. Allow 1/2" space at top and 1/2" space behind the machine compartment cover (located in the rear) for proper air circulation.

Subflooring or floor coverings (i.e. carpet, tile, wood floors, rugs) may make your opening smaller than anticipated.

Some clearance may be gained by using the leveling procedure under *Leveling*.

Important: If refrigerator is to be installed into a recess where the top of the refrigerator is completely covered, use distance from floor to top of hinge cap to verify proper clearance.

Transporting Your Refrigerator

- **NEVER** transport refrigerator on its side. If an upright position is not possible, lay refrigerator on its back. Allow refrigerator to sit upright for approximately 30 minutes before plugging it in to assure oil returns to the compressor. Plugging the refrigerator in immediately may cause damage to internal parts.
- Use an appliance dolly when moving refrigerator. **ALWAYS** truck refrigerator from its side or back—**NEVER** from its front.
- Protect outside finish of refrigerator during transport by wrapping cabinet in blankets or inserting padding between the refrigerator and dolly.
- Secure refrigerator to dolly firmly with straps or bungee cords. Thread straps through handles when possible. Do not overtighten. Overtightening restraints may dent or damage outside finish.

Leveling

⚠ CAUTION

To protect property and refrigerator from damage, observe the following:

- Protect vinyl or other flooring with cardboard, rugs, or other protective material.
- Do not use power tools when performing leveling procedure.

To enhance the appearance and maintain performance, the refrigerator should be level.

Note

- Complete any required door reversal, panel installation and/or a water supply connection, before leveling.

Materials Needed:

- 3/8" hex head driver
- Carpenter's level

1. Remove toe grille.

- Grasp firmly and pull outward to unclip.

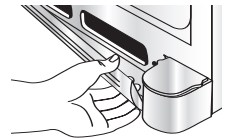

2. Remove bottom hinge cover(s).

- Place the eraser end of a pencil or similar blunt tool in the cover notch.

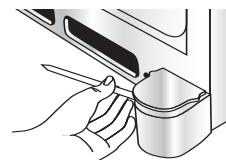

Notch Location →

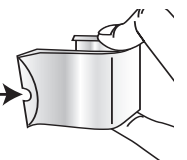

- Use slight pressure to pry the cover loose.

- Continue to maintain downward pressure to the notched side of the cover while swinging it off.

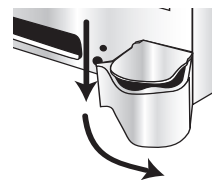

3. Using hex head driver, turn the front adjustment screws (A) on each side to raise or lower the front of the refrigerator.





Installation

Note

- Some models only have adjustment screws "A."

- Using the hex head driver, turn each of these adjustment screws (B) to raise or lower the rear of the refrigerator.
- Using the carpenter's level, make sure front of refrigerator is $\frac{1}{4}$ " (6 mm) or $\frac{1}{2}$ " bubble higher than back of refrigerator and that the refrigerator is level from side to side.
- Turn stabilizing legs (C) clockwise until firmly against floor.
- Turn adjustment screws (A) counterclockwise to allow the full weight of the refrigerator to rest on the stabilizing legs.
- Replace hinge cover(s).
 - Position cover into the outer edge of the hinge.
 - Swing the cover toward the cabinet and snap it into place.
- Replace the toe grille.

Note

- For proper reinstallation, ensure the "top" marking on the interior of the toe grille is oriented correctly.
 - Align the toe grille mounting clips with the lower cabinet slots.
 - Push the toe grille firmly until it snaps into place.

Door and Drawer Removal

Some installations require door/drawer removal to transport the refrigerator to its final location.

⚠ WARNING

To avoid electrical shock which can cause severe personal injury or death, observe the following:

- Disconnect power to refrigerator before removing doors or drawer. Connect power only after replacing doors or drawer.

⚠ CAUTION

To avoid damage to walls and flooring, protect vinyl or other flooring with cardboard, rugs or other protective material.

- Unplug power cord from power source.
- Remove toe grille and bottom hinge cover(s) (see page 3).
- Remove top hinge cover from refrigerator door by removing Phillips screw and retain screw and cover for later use.
- Unscrew $\frac{5}{16}$ " hex head screws from top hinge to remove hinge and retain all screws for later use.
- Lift right side refrigerator door from center hinge pin. Remove door closure from center hinge pin on the right side and retain for later use.
- Disconnect wire harness on top of left side refrigerator door top hinge.

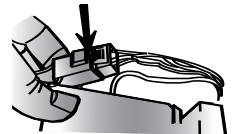
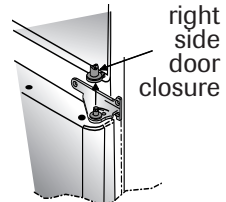
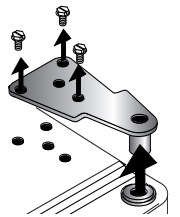
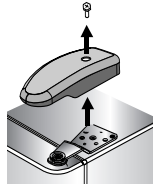

Release two-pin connector by pressing junction point with a flat blade screwdriver or fingernail.

Green ground wire remains attached to the hinge.

- Unscrew $\frac{5}{16}$ " hex head screws from top hinge to remove hinge and retain for later use.

Lift left side refrigerator door, along with top hinge, from center hinge pin.

Remove center hinge pin with a $\frac{5}{16}$ " hex head driver and retain hinge pin for later use.

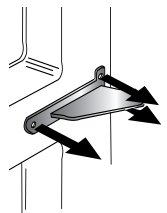

- Remove Phillips screws to remove right and left hinges and retain all screws for later use.

- Remove both stabilizing brackets with $\frac{3}{8}$ " hex head driver and retain screws for later use.

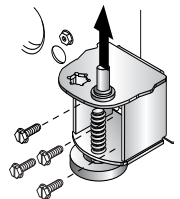



Installation

Pullout Freezer Drawer (select models)

⚠ DANGER

To prevent accidental child entrapment or suffocation risk, do not remove the divider in the top freezer basket.

⚠ WARNING

To avoid electrical shock which can cause severe personal injury or death, disconnect power to refrigerator before removing doors. After replacing doors, connect power.

⚠ CAUTION

To avoid possible injury, product, or property damage, you will need two people to perform the following instructions.

To Remove:

1. Pull drawer open to full extension.
2. Tilt the lower basket forward and lift to remove.
3. On each white drawer bracket is a basket cradle with two snap attachments. To release each cradle, unlatch the snaps by pushing them inward, away from the side bracket. Lift the cradles off of the rails.
4. Remove Phillips screw from each of the drawer slides (select models).
5. Lift top of drawer front to unhook the drawer from the slides. Lift door front out to remove.

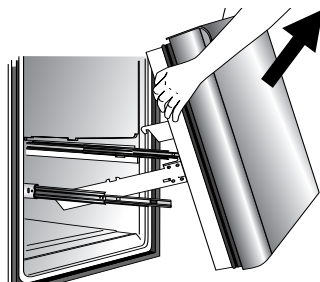
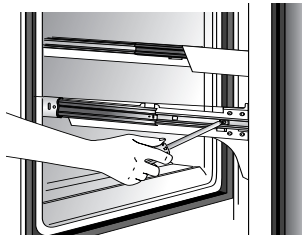
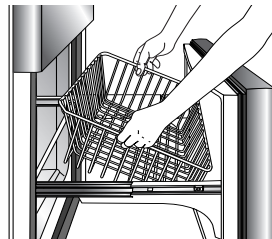

To Install:

1. Pull both rails out to full extension.
2. While supporting door front, hook supports into slots located on inside of each slide.

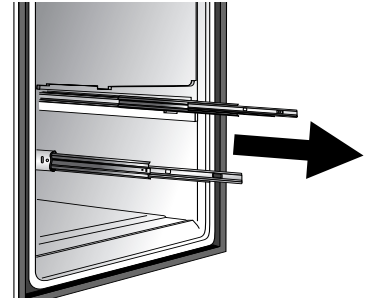

Note

- All four drawer bracket supports must be in the proper slots for the drawer to function properly.

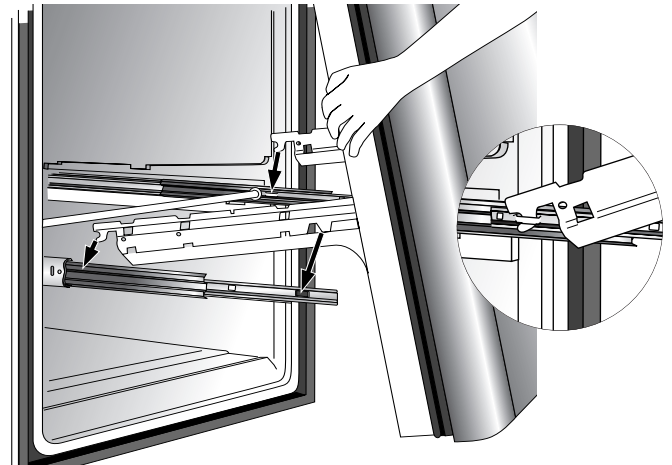

3. Lower door front into final position.
4. Replace and tighten Phillips screws that were removed from the drawer slides (select models).
5. Place the basket cradles back onto the drawer slides. Align basket cradle snaps with the slots on the drawer brackets and press each cradle towards the bracket until it clicks.

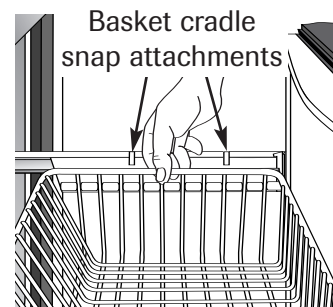

6. Tilt the lower basket front down and set it down into the basket cradles.



Installation

Door Reinstallation

1. Install hinge assemblies:
 - Install center hinge with Phillips screws.
2. Place hinge side of refrigerator door on center hinge pin.
 - Install top hinge with $\frac{5}{16}$ " hex head screws.
3. While holding refrigerator door upright, tighten down top hinge with $\frac{5}{16}$ " hex head driver.
4. Reconnect two-pin connector.
5. Replace top hinge covers.

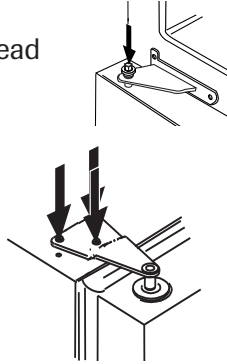

Handles

If not installed, the handle is located in the interior of the fresh food section or attached to the back of your refrigerator.

Remove and discard handle packaging and tape.

Front Mount Handle

Materials Needed:

- Gloves to protect hands
- Phillips screwdriver
- Plastic door removal card (or $\frac{1}{32}$ " thick plastic card), retain the card

Attach Extensions to Handle:

1. Align handle and extension as shown.
2. Place extension in handle opening.
3. Apply slight pressure to both sides of the extension piece.
4. Slide extension until it stops on inside edge of handle.

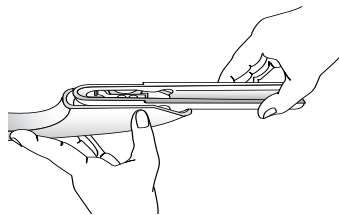

To Install:

1. The handles are to be oriented as shown.
2. Align front mount door handle clip with the door tabs.

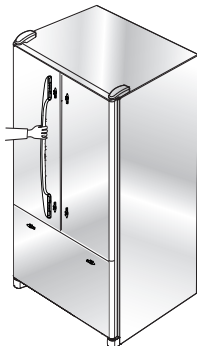

3. Ensure the handle clips are positioned slightly above the door tabs.

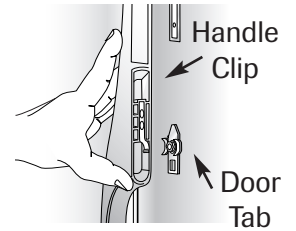

4. Rotate the handle so that the handle is flat against the door.

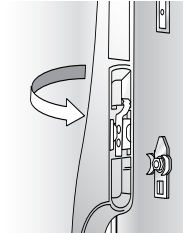

5. Push the handle down against the upper door tab just enough to allow it to hang unsupported.

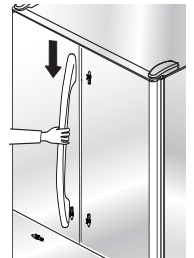

6. Align bottom of handle with lower door tab. Press upper handle end to door surface and firmly grasp lower end of handle. Gently slide handle upward until bottom of handle settles on door surface, then reverse direction, sliding downward to almost engaging tab with clip.

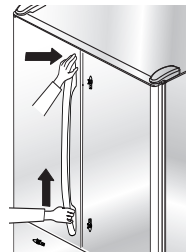

7. Grasp the handle firmly and slide down until it clicks. The audible click indicates fastening clips are securely interlocked.

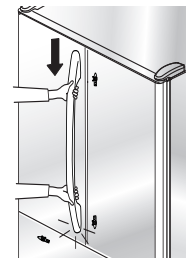

To Remove:

1. Flex the handle away from the door panel. Simultaneously place door handle removal card underneath the base of the lower handle. Insert the card to the line or until it stops.
2. Grasp the lower part of the handle firmly and lift to remove.

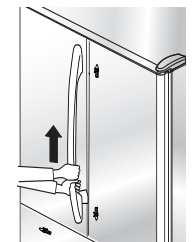
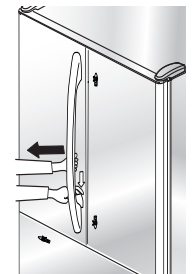



Installation

Freezer Handle

Materials Needed:

- Gloves to protect hands.
- Phillips screwdriver.
- Plastic handle removal card (or 1/32" thick plastic card). Retain the card.

Notes

- There is a slight curve to the freezer handle.
- For proper installation, be sure handle is oriented as shown.

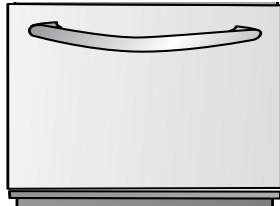

To Install:

1. Align door handle clips slightly to the left of the tabs attached to the freezer door.
2. Rotate the handle so the left base is flat against the door.

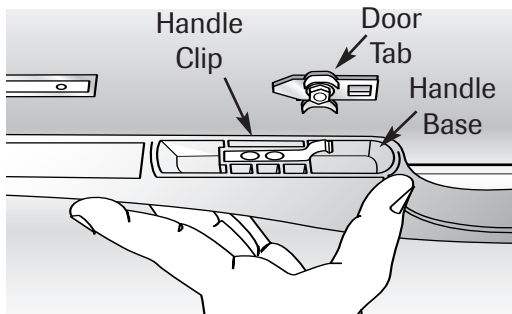

3. Push the left handle base against the left door tab and slightly to the right, just enough to allow it to hang unsupported.
4. While firmly supporting the left handle base against the door, align the right base of the handle with the right tabs that are attached to the door.
5. Now, while firmly holding the handle at the left and right bases, gently slide the handle towards the right until the right base settles in. The handle should now be flat against the face of the freezer door at both the left and right bases.
6. With hands still firmly keeping the handle flat against the freezer door, you may have to reverse directions momentarily to assure clip/tab

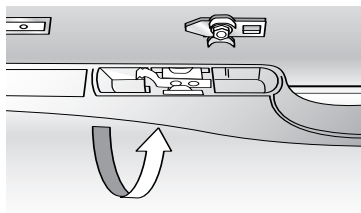

engagement. Then firmly slide the handle to the right until it clicks. The audible “click” indicates that the fastening clips are securely interlocked.

To Remove:

1. At the right end, flex the handle base away from the surface of the freezer drawer. Simultaneously slide the door handle removal card that came with your refrigerator under the right side base of the handle. Slide the card to the line indication or until it stops, which will be approximately 1 1/2”.
2. With both hands, firmly grasp the handle towards the right base.
3. Slide towards the left, lift and remove from the surface.

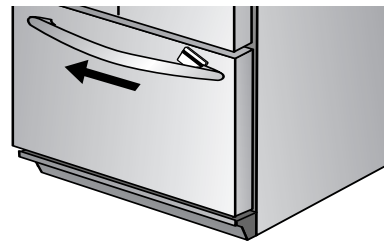

Installing Front-Mounted Handles for Stainless Steel Doors

1. Loosen lower door clip on door with a phillips screwdriver.
2. Locate predrilled hole at base of handle, and fit hollow end of handle over lower door clip.
3. Fit other end of handle over upper door clip and slide up as far as possible.

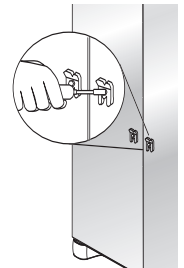

NOTE: If top of handle does not fit over top clip, loosen lower clip further until fit can be accomplished.

4. Insert phillips screwdriver into predrilled hole at base of handle to tighten screw. Insert plastic button plug into hole.
5. Repeat above steps to install other handle.

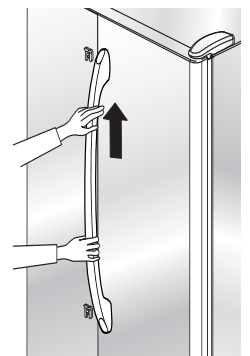
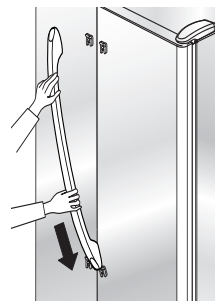



Installation

Removing Front-Mounted Handles for Stainless Steel Doors

1. Remove plastic button plug at base of handle with a very small flat-blade screwdriver.

- Insert phillips screwdriver into predrilled hole to remove screw.

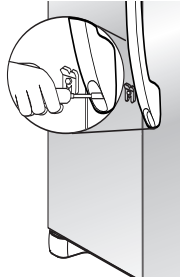

2. Slide handle down and remove from door clip.

3. Repeat above steps to remove other handle.

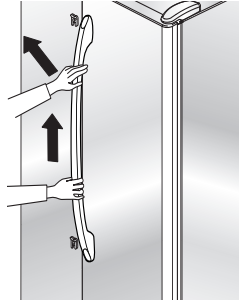

Installing Front-Mounted Handles for Stainless Steel Freezer Door

1. Loosen lower door clip on door with a phillips screwdriver

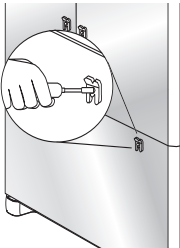

2. Locate predrilled hole at base of handle, and fit hollow end of handle over left door clip.



3. Fit other end of handle over left door clip and slide left as far as possible.

NOTE: If end of handle does not fit over left clip, loosen right clip further until fit can be accomplished.

4. Insert phillips screwdriver into predrilled hole at end of handle to tighten screw. Insert plastic button plug into hole.



Removing Front-Mounted Handles for Stainless Steel Freezer Door

1. Remove right side plastic button plugs at each end of handle with a very small flat-blade screwdriver.

- Insert phillips screwdriver into predrilled hole to remove screw.

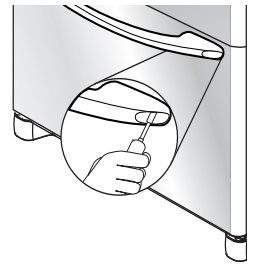

2. Slide handle right and remove from door clip.

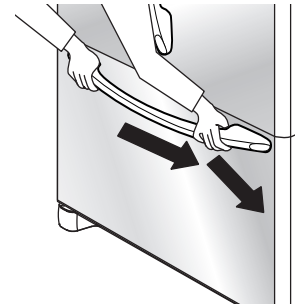

Connecting the Water Supply

⚠ WARNING

To reduce the risk of injury or death, follow basic precautions, including the following:

- Read all instructions before installing ice maker.
- Do not attempt installation if instructions are not understood or if they are beyond personal skill level.
- Observe all local codes and ordinances.
- Do not service ice maker unless specifically recommended in Use & Care Guide or published user-repair instructions.
- Disconnect power to refrigerator before installing ice maker.
- Water damage due to an improper water connection may cause mold/mildew growth. Clean up spills or leakage immediately!



Installation

⚠ CAUTION

To avoid property damage or possible injury, follow basic precautions, including the following:

- Consult a plumber to connect $\frac{1}{4}$ " O.D. copper tubing to household plumbing to assure compliance with local codes and ordinances.
- Confirm water pressure to water valve is between 35 and 100 pounds per square inch, 20 pounds per square inch without filter.
- Do not use a self-piercing, or $\frac{3}{16}$ " saddle valve. Both reduce water flow and can become clogged over time, and may cause leaks if repair is attempted.
- Tighten nuts by hand to prevent cross threading. Finish tightening nuts with pliers and wrenches. Do not overtighten.
- Wait two to three hours before placing refrigerator into final position to check and correct any water leaks. Recheck for leaks after 24 hours.
- Verify the copper tubing under the sleeve is smooth and free from defects. Do not reuse an old sleeve.

Materials Needed:

- $\frac{1}{4}$ " outer diameter flexible copper tubing
- Shut-off valve (requires a $\frac{1}{4}$ " hole to be drilled into water supply line before valve attachment)
- Adjustable wrench
- $\frac{1}{4}$ " hex nut driver

Notes

- Use copper tubing only for installation. Plastic is less durable and can cause damage.
- Add 8' to tubing length needed to reach water supply for creation of service loop.

1. Create service loop with copper tubing (minimum 2' diameter). Avoid kinks in the copper tubing when bending it into a service loop. Do not use plastic tubing.

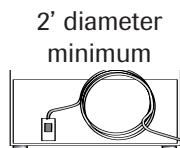

2. Remove plastic cap from water valve inlet port.



3. Place brass nut (A) and sleeve (B) on copper tube end as illustrated.

Reminder: Do not use an old sleeve. The nut and sleeve are provided in the use and care packet.

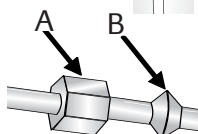

4. Place end of copper tubing into water valve inlet port. Shape tubing slightly. Do not kink – so that tubing feeds straight into inlet port.

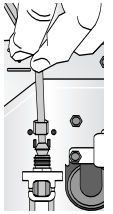

5. Slide brass nut over sleeve and screw nut into inlet port. Tighten nut with wrench.

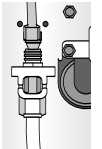

IMPORTANT: Do not overtighten. Cross threading may occur.

6. Pull on tubing to confirm connection is secure. Connect tubing to frame with water tubing clamp (C) and turn on water supply. Check for leaks and correct if necessary. Continue to observe the water supply connection for two to three hours prior to moving the refrigerator to its permanent location.

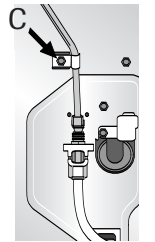

7. Monitor water connection for 24 hours. Correct leaks, if necessary.

Opening and Closing Your Fresh Food Doors

Your new refrigerator is uniquely designed with two fresh food doors. Either door can be opened or closed independently of one another.

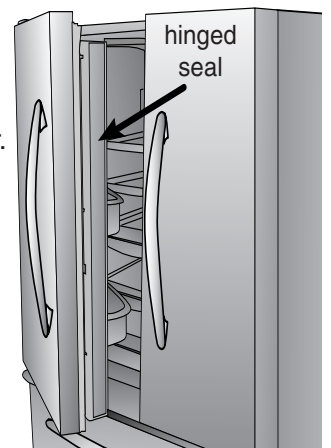

There is a vertically-hinged section on the left fresh food door. When the left door is closed, the hinged section automatically forms a seal between the two doors when both doors are closed.

When the left door is opened, the hinged seal automatically folds inward so that it is out of the way.

⚠ WARNING

To avoid electrical shock which can cause severe personal injury or death, **DO NOT** attempt to remove the hinged seal from the fresh food section.

⚠ CAUTION

To avoid possible product damage, **ALWAYS** verify that the hinged seal is folded against the edge of the door prior to closing.



Temperature Controls

Touch Temperature Controls

The controls are located at the top front of the refrigerator compartment.

Control



Initial Control Settings

After plugging the refrigerator in, set the controls.

- Pressing the or pads adjusts the controls to the desired setting.
- The temperature control range for both compartments is 1 through 7 (coldest).
- Initially set the refrigerator control on 4.
- Initially set the freezer control on 4.
- Let the refrigerator run at least 8 to 12 hours before adding food.

Warm Cabinet Surfaces

At times, the front of the refrigerator cabinet may be warm to the touch. This is a normal occurrence that helps prevent moisture from condensing on the cabinet. This condition will be more noticeable when you first start the refrigerator, during hot weather and after excessive or lengthy door openings.

Adjusting the Controls

- 24 hours after adding food, you may decide that one or both compartments should be colder or warmer. If so, adjust the control(s) as indicated in the *Temperature Control Guide* table below. See page 19 for instructions on checking compartment temperature.
- Except when starting the refrigerator, do not change either control more than one number at a time.
- Allow 24 hours for temperatures to stabilize.
- Changing either control will have some effect on the temperature of the other compartment.

Temperature Control Guide

Refrigerator too warm	Set the refrigerator control to next higher number by pressing the pad.
Refrigerator too cold	Set the refrigerator control to next lower number by pressing the pad.
Freezer too warm	Set the freezer control to next higher number by pressing the pad.
Freezer too cold	Set the freezer control to next lower number by pressing the pad.
Turn refrigerator OFF	Press the refrigerator or freezer pad until a dash (-) appears in the display.

Energy Saver Switch (select models)

- **Off** - The refrigerator uses more energy when this switch is off, because a heater located in the hinged seal section of the door is running. This heater helps prevent condensation formation on the exterior of the hinged seal. Turn the energy saver switch OFF when the environment is warm and more humid or if moisture is noticed on the door exterior.
- **On** - This setting saves energy by not using the heater. Turn the energy saver switch ON when the environment is less humid.



Temperature Controls

Triple Cool Climate Control (select models)

The control is located at the top front of the fresh food compartment.

Control

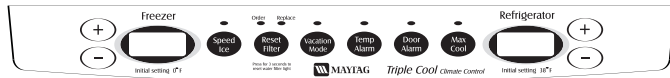

Initial Temperature Setting

Temperatures are preset at the factory at 38° F (3° C) in the fresh food compartment and 0° F (-18° C) in the freezer compartment.

Adjusting the Control

24 hours after adding food, you may decide that one or both compartments should be colder or warmer. If so, adjust the control as indicated in the Temperature Control Guide below.

- The first touch of the (+) or (-) pads shows the current temperature setting.
- The display will show the new setting for approximately three seconds, and then return to the actual temperature currently within that compartment.
- Do not change either control more than one degree at a time. Allow temperature to stabilize for 24 hours before making a new temperature adjustment.

Temperature Control Guide

Refrigerator too cold	Set the refrigerator control to next higher number by pressing the (+) pad.
Refrigerator too warm	Set the refrigerator control to next lower number by pressing the (-) pad.
Freezer too cold	Set the freezer control to next higher number by pressing the (+) pad.
Freezer too warm	Set the freezer control to next lower number by pressing the (-) pad.
Turn refrigerator OFF	Press the freezer (+) pad until OFF appears in the display. Press either the freezer or refrigerator (-) pad to turn back on.

Speed Ice



When activated, Speed Ice reduces the freezer temperature to the optimum setting for 24 hours in order to produce more ice. **Note:** When the Speed Ice feature is in operation, the (+) and (-) pads for the freezer control will not operate.

Reset Filter (select models)

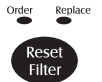

When a water filter has been installed in the refrigerator, the yellow **Order** light will illuminate when 90 percent of the volume of water for which the filter is rated has passed through the filter OR 11 months have elapsed since the filter has been installed.

The red **Replace** light will illuminate when the rated volume of water has passed through the filter OR 12 months have elapsed since the filter was installed. A new filter should be installed immediately when the **Replace** light is illuminated.

After replacing the filter, press and hold the **Reset Filter** pad for three seconds. The Order and Replace lights will go off.

Vacation Mode



The Vacation Mode feature causes the freezer to defrost less frequently, conserving energy. The Vacation Mode indicator light will illuminate when the feature is activated. To deactivate, press the Vacation Mode pad again OR open either door. The indicator light will go off.

Notes

- Door openings will not deactivate Vacation Mode for approximately one hour after activation.
- If vacationing for more than a few days, see the Preparing for Vacation section, page 25.

Temp Alarm



The Temp Alarm system will alert you if the freezer or fresh food temperatures exceed normal operating temperatures due to a power outage or other event. When activated, the Temp Alarm light will illuminate.



Temperature Controls

If the freezer or fresh food temperatures have exceeded these limits, the display will alternately show the current compartment temperatures and the highest compartment temperatures reached when the power was out. An audible alarm will sound repeatedly.

Press the Temp Alarm pad once to stop the audible alarm. The Temp Alarm light will continue to flash and the temperatures will alternate until the temperatures have stabilized.

To turn off Temp Alarm, press and hold the Temp Alarm pad for three seconds. The indicator light will go off.

Door Alarm



The Door Alarm will alert you when one of the doors has been left open for five continuous minutes. When this happens, an audible alarm will sound every few seconds until the door is closed OR the Door Alarm pad is pressed to deactivate the feature.

Max Cool



When activated, Max Cool causes the fresh food and freezer temperatures to drop to the minimum settings on the control. This cools down the refrigerator and freezer after extended door openings or when loading the refrigerator or freezer with warm food. **Note:** When the Max Cool feature is in operation, the (+) and (-) pads for the refrigerator and freezer controls will not operate.

To activate, press the Max Cool pad. Max Cool will deactivate automatically after 12 hours, OR press the Max Cool pad to deactivate the feature.

User Preferences

Access the User Preferences menu to:

- Activate or turn off Super Cool (select models)
- Change the temperature display from °F to °C
- Enable or disable audible alarms.
- Adjust the light level at which the Dispenser Auto Light will illuminate (when this feature is activated on the ice and water dispenser) (select models)
- Activate the Sabbath Mode

To access the User Preferences menu, press and hold the Door Alarm pad for three seconds. When in the User Preferences mode, a short title for the feature will appear in the Freezer temperature display and the feature status will appear in the Fresh Food display.

1. Use the Freezer up and down control to scroll through the features.
2. When the desired feature is displayed, use the Fresh Food up and down control to change the status.
3. When changes are complete, press the Door Alarm pad for three seconds OR close the Fresh Food door.

Super Cool (CC) (select models)

When Super Cool is ON, an air-mixing fan in the fresh food compartment is activated to improve air flow and temperature control. To save energy, this feature may be deactivated by choosing OFF.

Temperature Display (F_C)

Change the display to show temperatures in degrees Fahrenheit or degrees Celsius.

Alarm (AL)

When the Alarm mode is OFF, all audible alarms will be disabled until the feature is turned on.

Auto Light Level Selection (LL) (select models)

This setting adjusts the light level at which the dispenser light will illuminate when the sensor detects that the light levels in the room are low. Setting 1 is the darkest light level setting, setting 9 is the lightest light level setting. **Note:** The Auto Light (select models) must be activated on the ice and water dispenser control to take advantage of this option.

Sabbath Mode (SAB)

When the Sabbath Mode is ON, all control lights and the night light will be disabled until the feature is turned OFF. This feature does not disable the interior lights. Press any pad to restore the control lights.

Warm Cabinet Surfaces

At times, the front of the refrigerator cabinet may be warm to the touch. This is a normal occurrence that helps prevent moisture from condensing on the cabinet. This condition will be more noticeable when the refrigerator is first started, during hot weather and after excessive or lengthy door openings.



Fresh Food Features

Shelves

⚠ CAUTION

To avoid personal injury or property damage, observe the following:

- Never attempt to adjust a shelf that is loaded with food.
- Confirm shelf is secure before placing items on shelf.
- Handle tempered glass shelves carefully. Shelves may break suddenly if nicked, scratched, or exposed to sudden temperature change.

Your refrigerator has **Spill-Catcher™ Glass Shelves**. The shelves have a spill retainer edge which allows for easier clean up and some are equipped with a slide out feature. To slide out, grasp the front of the shelf and pull forward. Push in the shelf to return to the original position.

To Remove a Shelf:

- Slightly tilt up the front and lift up the rear of the shelf, then pull the shelf straight out.

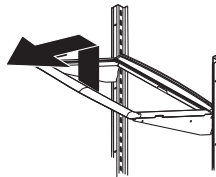

To Lock the Shelf Into Another Position:

- Tilt up the front edge of the shelf.
- Insert the hook into the desired frame openings and let the shelf settle into place.
- Be sure the shelf is securely locked at the rear.

Elevator™ Shelf (select models)

The **Elevator™ Shelf** is equipped with a spill-retaining edge and the EasyGlide™ slide-out feature. It can be adjusted up or down without unloading.

To Slide Out Elevator™ Shelf:

- Grasp the front of the shelf and pull forward.
- Push the shelf in to return to original position.

To Adjust the Elevator™ Shelf:

- Pull out the knob on the crank handle.
- Rotate the crank clockwise to raise the shelf, and counterclockwise to lower the height of the shelf.

To Remove Elevator™ Shelf:

- Completely unload the shelf and pull the shelf forward.
- Pull until the shelf stops.
- Press up on the tabs located underneath its outside edges and continue pulling forward until the shelf is clear of the frame.

To Replace Elevator™ Shelf:

- Align the shelf to the frame and push it all the way back. It is not necessary to press up on the tabs for reinstallation.

In ordinary use, the Elevator™ Shelf frame assembly does NOT require removal. Though unlikely, and not recommended, the correct removal procedure is as follows:

To Remove Frame Assembly:

- Unload the shelf completely.
- Slide the shelf forward about 2" and manually move the two rear latches toward the shelf center.
- While supporting the entire shelf and frame from underneath, lift slightly and rotate the assembly approximately 30° to allow the rear mechanism to clear the vertical rear side rails.
- The entire assembly can then be moved forward and clear of the refrigerator compartment.

To Reinstall Frame Assembly:

- Reverse the removal procedure. Be sure the shelf is in a level position. When the sliding shelf is pushed to the rear, it will reposition the rear latches to their correct operating position.

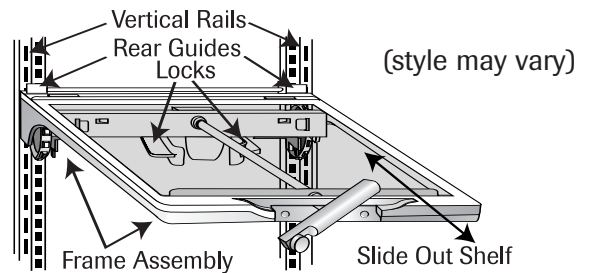



Fresh Food Features

The **Crisper Top** serves as the lower fresh food shelf.

To Remove the Crisper Top:

- Remove crisper drawers.
- Place hand under the frame to push up the glass. Lift glass out.
- Lift frame from refrigerator liner rails.

To Install:

- Replace frame in refrigerator liner rails.
- Carefully replace glass into frame.

Door Storage

Dairy Center

The **Dairy Center** provides convenient door storage for spreadable items such as butter and margarine. This compartment can be moved to different locations to accommodate storage needs. To use the dairy center, raise the cover.

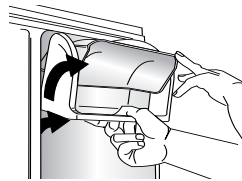

To Remove:

- Raise the cover, pull upward and tilt out.

To Install:

- Slide the Dairy Center in and down until firmly seated in the door liner.

Door Buckets

Door Buckets can be moved to meet storage needs.

To Remove:

- Slide bucket up and pull straight out.

To Install:

- Slide bucket in and down until firmly seated in the door liner.

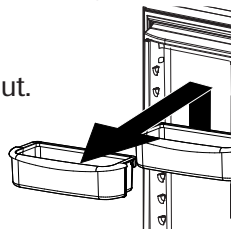

Crisper Drawers

The **Crisper Drawers** provide a higher humidity environment for fresh fruit and vegetable storage.

Controls

The **Crisper Controls** regulate the amount of humidity in the crisper drawer. Slide the control toward the **FRUIT** setting for produce with outer skins. Slide the control toward the **VEGETABLES** setting for leafy produce.

VEGETABLES

FRUIT

HUMIDITY CONTROLLED

To Remove:

- Pull drawer out to full extension. Tilt up front of drawer and pull straight out.

To Install:

- Insert drawer into frame rails and push back into place.



Note

- For best results, keep the crisper drawers tightly closed.

Temperature-Controlled Drawer

The **Wide-N-Fresh™** drawer is a full-width drawer with adjustable temperature control. This drawer can be used for large party trays, deli items, beverages or miscellaneous items and features a divider to organize the drawer into sections if desired.

There is a temperature control which adjusts the amount of cold air allowed into the drawer. The control is located on the right side of the drawer, under the lid.

Set the control to the **higher setting**  to provide a normal refrigerator temperature. Set the drawer on the **lower setting**  when a temperature colder than the main refrigerator compartment is desired. Use the coldest setting when storing meats.

Notes

- Cold air directed to the drawer can decrease refrigerator temperature. Refrigerator control may need to be adjusted.
- Do not place leafy vegetables in the drawer. Colder temperatures could damage leafy produce.

To Remove Drawer:

- Lift lid. Pull drawer out to full extension. Tilt up front of drawer and pull straight out.

To Install Drawer:

- Push metal glide rails to the back of the refrigerator. Place drawer onto rails and slide drawer back until it falls into place.



Fresh Food Features



Freezer Features

To Remove Divider:

- Pull drawer completely out and raise the front of the divider to unhook it from the rear wall of the drawer and lift it out.

To Install Divider:

- Hook back of divider over rear wall of drawer and lower into place

Accessories

Egg Tray

(style may vary/select models)

The **Egg Tray** holds a “dozen-plus” eggs. It can be removed to carry to a work area or to be washed.

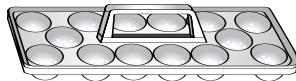

Wine Trivet/Can Rack (select models)

The **Wine Trivet/Can Rack** accessory fits in the Wide-N-Fresh™ drawer or on a shelf.

Bottles or cans can be laid crosswise, or a single bottle may be laid in the center depression.

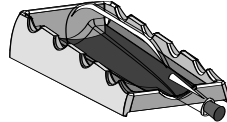

Upper Wire Basket

⚠ DANGER

To prevent accidental child entrapment or suffocation risk, do not remove the divider in the top freezer basket

To Remove:

- Pull upper basket out to full extension and lift out to remove.

To Install:

- Slide upper basket into freezer. Make sure that rear of basket hooks behind rail catch.

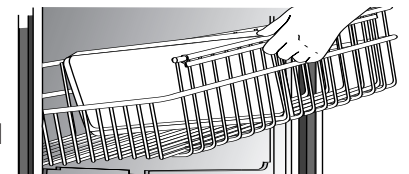

Note

- **Lower Freezer Drawer:** See page 5 for lower basket and complete pullout drawer instructions.

Accessories

Ice Bin

The **Ice Bin** provides storage for ice.

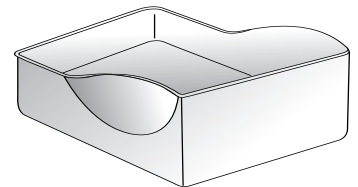



Ice and Water

Automatic Ice Maker

Connect the ice maker to the water supply as instructed on pages 8-10. **Proper water flow and a level refrigerator are essential for optimal ice maker performance.**

Operating Instructions

- Confirm ice bin is in place and ice maker arm is down.
- After freezer section reaches between 0° to 2° F (-18° to -17° C), ice maker fills with water and begins operating. You will have a complete harvest of ice approximately every three hours.
- Allow approximately 24 hours after installation to receive first harvest of ice.
- Discard ice created within first 12 hours of operation to assure system is flushed of impurities.
- Stop ice production by raising ice maker arm until click is heard.
- Ice maker will remain in the off position until arm is pushed down.
- The first one or two batches will probably contain undersized and irregular cubes because of air in the supply line.
- When the ice cubes are ejected it is normal for several cubes to be joined together at the ends. They can easily be broken apart. The ice maker will continue to make ice until the supply of ice cubes raises the ice maker arm, shutting the ice maker off.
- Certain sounds may accompany the various cycles of the ice maker. The motor may have a slight hum, the cubes will rattle as they fall into an empty storage pan and the water valve may click or “buzz” occasionally.
- If the ice is not used frequently, the ice cubes will become cloudy, shrink, stick together and taste stale. Empty the ice storage bin periodically and wash it in lukewarm water. Be sure to dry the bin thoroughly before replacing it.
- Beverages and foods should not be placed in the ice storage bin for quick chilling. These items can block the ice maker arm, causing the ice maker to malfunction.

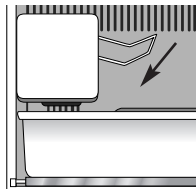

- Turn off (arm up) the ice maker when the water supply is to be shut off for several hours.

To Remove the Ice Bin:

- Pull it forward, away from the ice maker. To avoid the ice maker dumping ice while the bin is removed, turn the ice maker off by raising the ice maker arm.

To Install the Ice Bin:

- Reverse the above procedure. Turn the ice maker on by lowering the ice maker arm.

⚠ WARNING

To avoid personal injury or property damage, observe the following:

- Do not place fingers or hands on the automatic ice making mechanism while the refrigerator is plugged in. This will help protect you from possible injury. It will also prevent interference with moving parts of the ejector mechanism and the heating element that releases the cubes.
- Under certain rare circumstances, ice cubes may be discolored, usually appearing with a greenish hue. The cause of this unusual discoloration can be a combination of factors such as certain characteristics of local waters, household plumbing and the accumulation of copper salts in an inactive water supply line which feeds the ice maker. Continued consumption of such discolored ice cubes may be injurious to health. If such discoloration is observed, discard the ice cubes and contact your dealer to purchase and install a water line filter.
- Water damage due to improper water connection may cause mold/mildew growth.
- Clean up water and ice spills to avoid personal injury and to prevent mold/mildew growth.

Water Dispenser (select models)

The **Water Dispenser** is located on the left side wall of the fresh food section. This design is for cold water dispensing only.

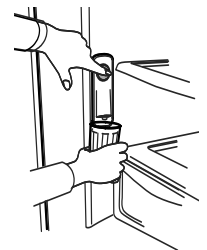

To Dispense Water:

- Hold container under spout and press dispenser pad.



Water Filter (select models)

Water Filter Removal and Installation

⚠ WARNING

To avoid serious illness or death, do not use refrigerator where water is unsafe or of unknown quality without adequate disinfection before or after use of filter.

⚠ CAUTION

After installing a new water filter, always dispense water for two minutes before removing the filter for any reason. Air trapped in system may cause water and cartridge to eject. Use caution when removing.

- The bypass cap does not filter water. Be sure to have replacement cartridge available when filter change is required.
- If water filtration system has been allowed to freeze, replace filter cartridge.
- If system has not been used for several months, or water has an unpleasant taste or odor, flush system by dispensing water for two to three minutes. If unpleasant taste or odor persists, change filter cartridge.

Initial Installation

The water filter is located in the upper right-hand corner of the fresh food compartment.

1. Remove blue bypass cap and retain for later use.
 2. Remove sealing label from end of filter and insert into filter head.
 3. Rotate gently clockwise until filter stops. Snap filter cover closed.
 4. Reduce water spurts by flushing air from system. Run water continuously for two minutes through dispenser until water runs steady. During initial use, allow about a one- to two-minute delay in water dispersal to allow internal water tank to fill.
- Additional flushing may be required in some households where water is of poor quality.

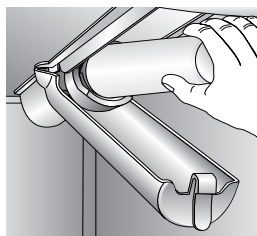
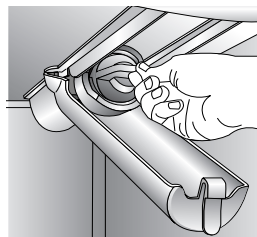

Replacing Water Filter

IMPORTANT: Air trapped in system may cause water and cartridge to eject. Always dispense water for at least 2 minutes before removing the filter for any reason. Use caution when removing.

1. Turn filter counterclockwise until it releases from filter head.
2. Drain water from filter into sink, and dispose in normal household trash.
3. Wipe up excess water in filter cover and continue with *Initial Installation*, steps 2 through 4.

The filter should be changed at least every 12 months.

IMPORTANT: Condition of water and amount used determines life span of water filter cartridge. If water use is high, or if water is of poor quality, replacement may need to take place more often.

To purchase a replacement water filter cartridge, contact your dealer or call 1-877-232-6771 U.S.A. or 1-800-688-8408 Canada.

The dispenser feature may be used without a water filter cartridge. If you choose this option, replace filter with blue bypass cap.

State of California
Department of Health Services

Water Treatment Device Certificate Number

03 - 1583

Date Issued: September 16, 2003
Date Revised: April 22, 2004

Trademark/Model Designation Replacement Elements

UKF8001AXX750	UKF8001AXX
469006-750	46 9006
67003523-750	67003523

Manufacturer: PentaPure Inc.

The water treatment device(s) listed on this certificate have met the testing requirements pursuant to Section 116830 of the Health and Safety Code for the following health related contaminants:

Microbiological Contaminants and Turbidity	Inorganic/Radiological Contaminants
Cysts	Asbestos
Turbidity	Lead
	Mercury

Organic Contaminants

Atrazine
Lindane
Benzene
Carbofuran
p-dichlorobenzene
Toxaphene

Rated Service Capacity: 750 gal.

Rated Service Flow: 0.78 gpm

Conditions of Certification:

Do not use where water is microbiologically unsafe or with water of unknown quality, except that systems certified for cyst reduction may be used on disinfected waters that may contain filterable cysts.



Water Filter (select models)

PuriClean® II System Specification and Performance Data Sheet Refrigerator Water Filter Cartridge Model UKF8001AXX

Specifications

Service Flow Rate (Maximum).....0.78 GPM (2.9 L/min)
 Rated Service Life UKF8001AXX-750 (Maximum).....750 gallons/2838 liters
 Maximum Operating Temperature100° F/38° C
 Minimum Pressure Requirement.....35 psi/241 kPA
 Minimum Operating Temperature.....33° F/1° C
 Maximum Operating Pressure.....120 psi/827 kPA



1000 Apollo Road
 Eagan, Minnesota 55121-2240
 651.450.4913
 EPA EST #35917-MN-1

100834/B

Performance Data

Standard No. 42: Aesthetic Effects								
Parameter	USEPA MCL	Influent Challenge Concentration	Influent Average	Effluent		% Reduction		Min. Required Reduction
				Average	Maximum	Average	Minimum	
Chlorine	–	2.0 mg/L ± 10%	1.88 mg/L	<0.05136364 mg/L	0.06 mg/L	>97.26%	96.84%	50%
T & O	–	–	–	–	–	–	–	–
Particulate**	–	at least 10,000 particles/ml	5,700,000 #/ml	30,583 #/ml	69,000 #/ml	99.52%	98.94%	85%

Standard No. 53: Health Effects								
Parameter	USEPA MCL	Influent Challenge Concentration	Influent Average	Effluent		% Reduction		Min. Required Reduction
				Average	Maximum	Average	Minimum	
Turbidity	1 NTU**	11 ± 1 NTU***	10.7 NTU	0.31 NTU	.049 NTU	97.09%	95.20%	0.5 NTU
Cysts	99.5% Reduction	Minimum 50,000/L	166,500 #/L	<1 #/L	<1 #/L	>99.99%	>99.99%	>99.95%
Asbestos	99% Reduction	10 ⁷ 10 ⁶ fibers/L; fibers >10 micrometers in length	155 MF/L	<1 MF/L	<1 MF/L	>99.99%	>99.99%	99%
Lead at pH 6.5	0.015 mg/L	0.15 mg/L + 10%	0.153 mg/L	<.001 mg/L	<.001 mg/L	>99.35%	>99.29%	0.10 mg/L
Lead at pH 8.5	0.015 mg/L	0.15 mg/L + 10%	0.150 mg/L	<.001 mg/L	<.001 mg/L	>99.33%	>99.29%	0.10 mg/L
Mercury at pH 6.5	0.002 mg/L	.006 mg/L ± 10%	0.006 mg/L	0.0003 mg/L	0.0005 mg/L	95.70%	90.91%	0.002 mg/L
Mercury at pH 8.5	0.002 mg/L	.006 mg/L ± 10%	0.006 mg/L	0.0008 mg/L	0.0015 mg/L	86.22%	75.93%	0.002 mg/L
Atrazine	0.003 mg/L	0.009 mg/L + 10%	0.009 mg/L	<0.002 mg/L	0.002 mg/L	76.99%	75.31%	0.003 mg/L
Benzene	0.005 mg/L	0.015 mg/L ± 10%	0.014 mg/L	0.0006 mg/L	0.0011 mg/L	95.71%	92.14%	0.005 mg/L
Carbofuran	0.04 mg/L	0.08 mg/L ± 10%	0.081 mg/L	<0.001 mg/L	<0.001 mg/L	98.74%	98.46%	0.04 mg/L
p-Dichlorobenzene	0.075 mg/L	.225 mg/L ± 10%	0.208 mg/L	<0.0005 mg/L	<0.0005 mg/L	99.76%	99.74%	0.075 mg/L
Lindane	0.0002 mg/L	0.002 mg/L + 10%	0.002 mg/L	0.000 mg/L	<0.0001 mg/L	98.72%	96.50%	0.0002 mg/L
Toxaphene	0.003 mg/L	0.015 ± 10%	0.015 mg/L	<0.001 mg/L	<0.001 mg/L	92.97%	91.67%	0.003 mg/L

* Tested using a flow rate of 0.78 gpm; pressure of 60 psig; pH of 7.5 + 0.5; temp. of 68° + 5° F (20° + 3° C)

** Measurement in Particles/ml. Particles used were 0.5 - 1 microns

*** NTU - Nephelometric Turbidity Units



Tested and certified by NSF International against ANSI/NSF Standards 42 & 53 in models UKF8001AXX-750 for the reduction of:

Standard No. 42: Aesthetic Effects

Taste and Odor Reduction
 Chlorine Taste & Odor
 Mechanical Filtration Unit
 Particulate Reduction Class 1

Standard No. 53: Health Effects

Chemical Reduction Unit
 Lead, Atrazine, Lindane, Benzene, Carbofuran, p-Dichlorobenzene, Mercury & Toxaphene Reduction
 Mechanical Filtration Unit
 Cyst, Turbidity and Asbestos Reduction

General Use Conditions

Read this Performance Data Sheet and compare the capabilities of this unit with your actual water treatment needs.

DO NOT use this product where water is microbiologically unsafe or of unknown quality without adequate disinfection before or after the system. System certified for cyst reduction may be used on disinfected water that may contain filterable cysts.

USE ONLY WITH COLD WATER SUPPLY. CHECK FOR COMPLIANCE WITH THE STATE AND LOCAL LAWS AND REGULATIONS.

The PuriClean® II retractable water filtration system uses a UKF8001AXX replacement cartridge. Timely replacement of filter cartridge is essential for performance satisfaction from this filtration system. Please refer to the applicable section of your Use & Care Guide for general operation, maintenance requirements and troubleshooting. Suggested retail price of replacement water filter is \$39.99.

This system has been tested according to ANSI/NSF 42 and 53 for reduction of the substance listed above. The concentration of the indicated substances in water entering the system was reduced to a concentration less than or equal to the permissible limit for water leaving the system, as specified in ANSI/NSF 42 and 53.



Food Storage Tips

Fresh Food Storage

- The fresh food compartment of a refrigerator should be kept between 34°-40° F (1°-4° C) with an optimum temperature of 37° F (3° C). To check the temperature, place an appliance thermometer in a glass of water and place in the center of the refrigerator. Check after 24 hours. If the temperature is above 40° F (4° C) adjust the controls as explained on pages 10-12.
- Avoid overcrowding the refrigerator shelves. This reduces the circulation of air around the food and results in uneven cooling.

Fruits and Vegetables

- Storage in the crisper drawers traps humidity to help preserve the fruit and vegetable quality for longer time periods (see page 14).
- Sort fruits and vegetables before storage and use bruised or soft items first. Discard those showing signs of decay.
- Always wrap odorous foods such as onions and cabbage so the odor does not transfer to other foods.
- While vegetables need a certain amount of humidity to remain fresh, too much humidity can shorten storage times (especially leafy vegetables). Drain vegetables well before storing.
- Wait to wash fresh produce until right before use.

Meat and Cheese

- Raw meat and poultry should be wrapped securely so leakage and contamination of other foods or surfaces does not occur.
- Occasionally mold will develop on the surface of hard cheeses (Swiss, Cheddar, Parmesan). Cut off at least an inch around and below the moldy area. Keep your knife or instrument out of the mold itself. Do not try to save individual cheese slices, soft cheese, cottage cheese, cream, sour cream or yogurt when mold appears.

Dairy Food

- Most dairy foods such as milk, yogurt, sour cream and cottage cheese have freshness dates on their cartons for appropriate length of storage. Store these foods in the original carton and refrigerate immediately after purchasing and after each use.

Frozen Food Storage

- The freezer compartment of a refrigerator should be kept at approximately 0° F (-18° C). To check the temperature, place an appliance thermometer between the frozen packages and check after 24 hours. If the temperature is above 0° F (-18° C), adjust the control as described on pages 10-12.
- A freezer operates more efficiently when it is at least two-thirds full.

Packaging Foods for Freezing

- To minimize dehydration and quality deterioration use aluminum foil, freezer wrap, freezer bags or airtight containers. Force as much air out of the packages as possible and be sure they are tightly sealed. Trapped air can cause the food to dry out, change color and develop an off-flavor (freezer burn).
- Overwrap fresh meats and poultry with suitable freezer wrap prior to freezing.
- Do not refreeze meat that has completely thawed.

Loading the Freezer

- Avoid adding too much warm food to the freezer at one time. This overloads the freezer, slows the rate of freezing and can raise the temperature of frozen foods.
- Leave space between the packages so cold air can circulate freely, allowing food to freeze as quickly as possible.
- Avoid storing hard-to-freeze foods such as ice cream and orange juice on the freezer door shelves. These foods are best stored in the freezer interior where the temperature varies less with door openings.

Refer to the *Food Storage Chart* on pages 20 and 21 for approximate storage times.



Food Storage Tips

Food Storage Chart

Storage times are approximate and may vary depending on type of packaging, storage temperature, and the quality of the food when purchased.

FOODS	REFRIGERATOR	FREEZER	STORAGE TIPS
DAIRY PRODUCTS			
Butter	1 month	6 to 9 months	Wrap tightly or cover.
Milk and cream	1 week	Not recommended	Check carton date. Close tightly. Don't return unused portions to original container. Don't freeze cream unless whipped.
Cream cheese, cheese spread and cheese food	1 to 2 weeks	Not recommended	Wrap tightly.
Cottage cheese	3 to 5 days	Not recommended	Store in original carton. Check carton date.
Sour cream	10 days	Not recommended	Store in original carton. Check carton date.
Hard cheese (Swiss, Cheddar and Parmesan)	1 to 2 months	4 to 6 months May become crumbly	Wrap tightly. Cut off any mold.
EGGS			
Eggs in the shell	3 weeks	Not recommended	Refrigerate small ends down.
Leftover yolks or whites	2 to 4 days	9 to 12 months	For each cup of yolks to be frozen, add 1 tsp. sugar for use in sweet, or 1 tsp. salt for non-sweet dishes.
FRUITS			
Apples	1 month	8 months (cooked)	May also store unripe or hard apples at 60° to 70° F (16° to 21° C).
Bananas	2 to 4 days	6 months (whole/peeled)	Ripen at room temperature before refrigerating. Bananas darken when refrigerated.
Pears, plums, avocados	3 to 4 days	Not recommended	Ripen at room temperature before refrigerating. Avocados darken when refrigerated.
Berries, cherries, apricots	2 to 3 days	6 months	Ripen at room temperature before refrigerating.
Grapes	3 to 5 days	1 month (whole)	Ripen at room temperature before refrigerating.
Citrus fruits	1 to 2 weeks	Not recommended	May also store at 60° to 70° F (16° to 21° C). If refrigerated, store uncovered.
Pineapples, cut	2 to 3 days	6 to 12 months	Will not ripen after purchase. Use quickly.



Food Storage Tips

FOODS	REFRIGERATOR	FREEZER	STORAGE TIPS
VEGETABLES			
Asparagus	1 to 2 days	8 to 10 months	Do not wash before refrigerating. Store in crisper.
Brussels sprouts, broccoli, cauliflower, green peas, lima beans, onions, peppers	3 to 5 days	8 to 10 months	Wrap odorous foods. Leave peas in pods.
Cabbage, celery	1 to 2 weeks	Not recommended	Wrap odorous foods and refrigerate in crisper.
Carrots, parsnips, beets and turnips	7 to 10 days	8 to 10 months	Remove tops. Wrap odorous foods and refrigerate in the crisper.
Lettuce	7 to 10 days	Not recommended	
POULTRY and FISH			
Chicken and Turkey, whole	1 to 2 days	12 months	Keep in original packaging for refrigeration. Place in the meat and cheese drawer. When freezing longer than two weeks, overwrap with freezer wrap.
Chicken and Turkey, pieces	1 to 2 days	9 months	
Fish	1 to 2 days	2 to 6 months	
MEATS			
Bacon	7 days	1 month	
Beef or lamb, ground	1 to 2 days	3 to 4 months	Fresh meats can be kept in original packaging for refrigeration.
Beef or lamb, roast and steak	3 to 5 days	6 to 9 months	Place in the meat and cheese drawer. When freezing longer than two weeks, overwrap with freezer wrap.
Ham, fully cooked, whole	7 days	1 to 2 months	
half	5 days	1 to 2 months	
slices	3 days	1 to 2 months	
Luncheon meat	3 to 5 days	1 to 2 months	Unopened, vacuum-packed luncheon meat may be kept up to two weeks in the meat and cheese drawer.
Pork, roast	3 to 5 days	4 to 6 months	
Pork, chops	3 to 5 days	4 months	
Sausage, ground	1 to 2 days	1 to 2 months	
Sausage, smoked	7 days	1 to 2 months	
Veal	3 to 5 days	4 to 6 months	
Frankfurters	7 days	1 month	Processed meats should be tightly wrapped and stored in the meat and cheese drawer.

Sources: United States Department of Agriculture; Food Marketing Institute; Cooperative Extension Service, Iowa State University



Care and Cleaning

⚠ WARNING

To avoid electrical shock which can cause severe personal injury or death, disconnect power to refrigerator before cleaning. After cleaning, connect power.

⚠ CAUTION

To avoid personal injury or property damage, observe the following:

- Read and follow manufacturer's directions for all cleaning products.
- Do not place buckets, shelves or accessories in dishwasher. Cracking or warping of accessories may result.

Refrigerator Cleaning Chart

PART	DO NOT USE	DO
Textured Doors and Exterior (select models)	Abrasive or harsh cleaners Ammonia Chlorine bleach	Use 4 tablespoons of baking soda dissolved in 1 quart (1 liter) warm soapy water. Rinse surfaces with clean warm water and dry immediately to avoid water spots.
Cabinet Interior	Concentrated detergents or solvents Metal or plastic-textured scouring pads	
Stainless Steel Doors and Exterior (select models) IMPORTANT: <i>Damage to stainless steel finish due to improper use of cleaning products or non-recommended products is not covered under this product's warranty.</i>	Abrasive or harsh cleaners Ammonia Chlorine bleach Concentrated detergents or solvents Metal or plastic-textured scouring pads Vinegar-based products Citrus-based cleaners	Use warm, soapy water and a soft, clean cloth or sponge. Rinse surfaces with clean warm water and dry immediately to avoid water spots. To polish and help prevent finger prints, follow with Stainless Steel Magic Spray (part no. 20000008*).
Door Gaskets	Abrasive or harsh cleaners Metal or plastic-textured scouring pads	Use warm, soapy water and a soft, clean cloth or sponge.
Condenser Coil <i>Remove base grille to access.</i>	Anything other than a vacuum cleaner	Use a vacuum cleaner hose nozzle.
Condenser Fan Outlet Grille <i>See back of refrigerator.</i>		Use a vacuum cleaner hose nozzle with brush attachment.
Accessories <i>Shelves, buckets, drawers, etc.</i>	A dishwasher	Follow removal and installation instructions from appropriate feature section. Allow items to adjust to room temperature. Dilute mild detergent and use a soft clean cloth or sponge for cleaning. Use a plastic bristle brush to get into crevices. Rinse surfaces with clean warm water. Dry glass and clear items immediately to avoid spots.

* To order, call 1-877-232-6771 U.S.A. or 1-800-688-8408 Canada.



Care and Cleaning

Removing Odors From Refrigerator

⚠ WARNING

To avoid electrical shock which can cause severe personal injury or death, disconnect power to refrigerator before cleaning. After cleaning, reconnect power.

1. Remove all food and turn the refrigerator OFF.
2. Disconnect power to the refrigerator.
3. Clean the walls, floor, ceiling of cabinet interior, drawers, shelves and gaskets according to the instructions on page 22.
4. Dilute mild detergent and brush solution into crevices using a plastic bristle brush. Let stand for 5 minutes. Rinse surfaces with warm water. Dry surfaces with a soft, clean cloth.
5. Wash and dry all bottles, containers and jars. Discard spoiled or expired items.
6. Wrap or store odor-causing foods in tightly sealed containers to prevent recurring odors.
7. Reconnect power to refrigerator and return food to refrigerator.
8. Allow the refrigerator to cool.
9. After 24 hours, check if odor has been eliminated.

If odor is still present:

1. Remove drawers and place on top shelf of refrigerator.
2. Pack refrigerator and freezer sections – including doors – with crumpled sheets of black and white newspaper.
3. Place charcoal briquettes randomly on crumpled newspaper in both freezer and refrigerator compartments.
4. Close doors and let stand 24 to 48 hours.

Energy Saving Tips

- Avoid overcrowding refrigerator shelves. Overcrowding reduces air circulation around food and causes refrigerator to run longer.
- Avoid adding too much warm food to refrigerator at one time. This overloads compartments and slows rate of cooling.
- Do not use aluminum foil, wax paper, or paper toweling as shelf liners. This decreases air flow and causes refrigerator to run less efficiently.
- A freezer that is two-thirds full runs most efficiently.
- Locate refrigerator in coolest part of room. Avoid areas of direct sunlight, or near heating ducts, registers or other heat producing appliances. If this is not possible, isolate exterior by using a section of cabinet or an added layer of insulation.
- Clean door gaskets every three months according to cleaning instructions. This will assure that door seals properly and refrigerator runs efficiently.
- Take time to organize items in refrigerator to reduce time that door is open.
- Be sure your doors are closing securely by leveling refrigerator as instructed in your installation instructions.
- Clean condenser coils as indicated in the cleaning instructions every three months. This will increase energy efficiency and cooling performance.

Care and Cleaning

Replacing Light Bulbs

WARNING

To avoid electrical shock which can cause severe personal injury or death, disconnect power to refrigerator before replacing light bulb. After replacing light bulb, reconnect power.

CAUTION

To avoid personal injury or property damage, observe the following:

- Allow light bulb to cool.
- Wear gloves when replacing light bulb.

Fresh Food Section (style of light shield varies)

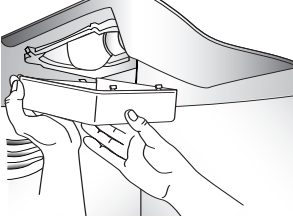
1. Slide clear light shield toward back of compartment to release from light assembly. 
2. Remove light bulbs.
3. Replace with appliance bulbs **no greater than 40 watts**.
4. Replace light bulb cover by inserting tabs on light shield into liner holes on each side of light assembly. Slide shield toward front of refrigerator until it locks into place. Do not force shield beyond locking point. Doing so may damage light shield.

Freezer (style of light shield varies)

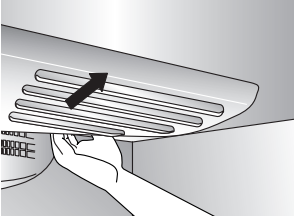
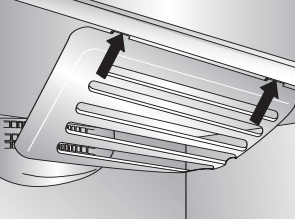
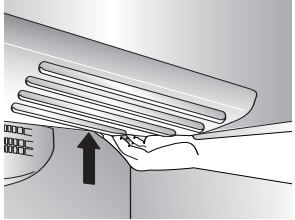
1. Reach behind the light cover. 
2. With firm pressure, press forward on the notches at the back of the cover and pull down. The cover will open from the back. 
3. Remove the cover.
4. Remove light bulb.
5. Replace bulb with appliance bulb **no greater than 40 watts**.
6. Insert front tabs of light cover into slots in freezer liner and snap rear portion over light assembly until rear tab engages. 



Care and Cleaning

Preparing for Vacation

⚠ CAUTION

If your refrigerator has a dispenser and if there is any possibility that the temperature can drop below freezing where the refrigerator is located, the water supply system (including the water tank and the water valve) must be drained by a qualified servicer.

For short vacations or absences (three months or less):

1. Remove all perishables.
2. If no one will be checking in on the refrigerator during your absence, remove all frozen items also.
3. If your refrigerator has an automatic ice maker:
 - Shut off the water supply to the ice maker at least one day ahead of time.
 - After the last load of ice drops, raise the wire shut off arm to the OFF position.
 - Empty the ice bin.
4. If the room temperature will drop below 55° F (13° C), follow the instructions for longer absences.

For long vacations, absences (more than three months) OR if the room temperature will drop below 55° F (13° C):

1. Remove food.
2. If your refrigerator has an automatic ice maker:
 - Shut off the water supply to the ice maker at least one day ahead of time.
 - After the last load of ice drops, raise the wire shut off arm to the OFF position.
 - Empty the ice bin.
3. If your refrigerator has a dispenser system with water filter, remove the water filter cartridge and install the filter bypass. Dispose of the used cartridge.
4. Turn the freezer control to OFF.
5. Unplug the refrigerator.
6. Thoroughly clean the interior of both compartments with a baking soda solution and a clean soft cloth (four tablespoons of baking soda in one quart of warm water).
7. Dry thoroughly.
8. Leave the doors open to prevent the formation of mold and mildew.

Upon your return

After a short vacation or absence:

For models with automatic ice makers or dispensers:

- Reconnect the water supply and turn on supply valve (see pages 8-9).
- Monitor water connection for 24 hours and correct leaks if necessary.
- Run 10-15 glasses of water from the dispenser to flush out the system.
- Restart the ice maker by lowering the ice maker arm.
- Discard at least the first three ice harvests.

After a long vacation or absence:

- Reconnect the water supply and turn on supply valve (see pages 8-9).
- Plug the refrigerator back in and reset controls (see pages 10-12).
- Monitor water connection for 24 hours and correct leaks, if necessary.

For dispenser models, run water through the dispenser for at least three minutes with the filter bypass in place, then install water filter (see page 17).

- After installing the water filter, run water through the dispenser continuously for at least two minutes, or until water runs steady. Initially you may notice a one to two minute delay in water dispersal as the internal tanks fills.
- Restart the ice maker by lowering the ice maker arm.
- Discard ice produced within the first 12 hours (at least the first three harvests).

Preparing to move

- Follow the above instructions for long vacations/absences, through step 7.
- Secure all loose items such as shelves and drawers by taping them securely in place to prevent damage.
- Tape the doors shut.
- Use an appliance dolly when moving the refrigerator. Always truck the refrigerator from its side or back - never from its front.
- Be sure the refrigerator stays in an upright position during moving.

Operating Sounds

Improvements in refrigeration design may produce sounds in your new refrigerator that are different or were not present in an older model. These improvements were made to create a refrigerator that is better at preserving food, is more energy efficient, and is quieter overall. Because new refrigerators run quieter, sounds may be detected that were present in older refrigerators, but were masked by higher sound levels. Many of these sounds are normal. Please note that the surfaces adjacent to a refrigerator, such as hard walls, floors and cabinetry may make these sounds seem even louder. The following are some of the normal sounds that may be noticed in a new refrigerator.

SOUND	POSSIBLE CAUSE	SOLUTION
Clicking	• Freezer control (A) clicks when starting or stopping compressor.	• Normal operation
	• Motorized device (B) sounds like an electric clock and snaps in and out.	• Normal operation
Air rushing or whirring	• Freezer fan (C) and condenser fan (D) make this noise while operating.	• Normal operation
Gurgling or boiling sound	• Evaporator (E) and heat exchanger (F) refrigerant makes this noise when flowing.	• Normal operation
Thumping	• Ice cubes from ice maker (select models) drop into ice bucket (G) .	• Normal operation
Vibrating noise	• Compressor (H) makes a pulsating sound while running.	• Normal operation
	• Refrigerator is not level.	• See page 3 for details on how to level your refrigerator.
Buzzing	• Ice maker water valve (I) hookup (select models) buzzes when ice maker fills with water.	• Normal operation
Humming	• Ice maker (J) is in the 'on' position without water connection.	• Stop sound by raising ice maker arm to OFF position (see page 16).
	• Compressor (H) can make a high-pitched hum while operating.	• Normal operation
Hissing or popping	• Defrost heater (K) hisses, sizzles or pops when operational.	• Normal operation

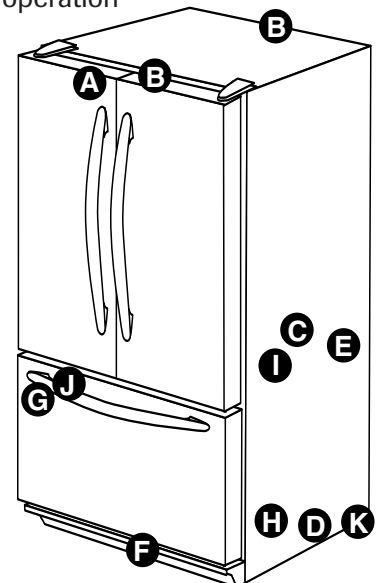

Troubleshooting

PROBLEM	POSSIBLE CAUSES	WHAT TO DO	
Freezer control and lights are on, but compressor is not operating	Refrigerator is in defrost mode.	Normal operation. Wait 40 minutes to see if refrigerator restarts.	
Crisper drawer temperature is too warm	Control settings are too low.	See pages 10-12 to adjust controls.	
Refrigerator does not operate	Refrigerator is not plugged in.	Plug in refrigerator.	
	Control is not on.	See pages 10-12 to adjust your controls.	
	Fuse is blown, or circuit breaker needs to be reset.	Replace any blown fuses. Check circuit breaker and reset, if necessary.	
	Power outage has occurred.	Call local power company listing to report outage.	
Refrigerator still won't operate	Refrigerator is malfunctioning.	Unplug refrigerator and transfer food to another refrigerator. If another refrigerator is not available, place dry ice in freezer section to preserve food. Warranty does not cover food loss. Contact service for assistance.	
Food temperature is too cold	Condenser coils are dirty.	Clean according to the chart on page 22.	
	Refrigerator or freezer controls are set too high.	See pages 10-12 to adjust your controls.	
Food temperature is too warm	Door is not closing properly.	Refrigerator is not level. See page 3 for details on how to level your refrigerator. Check gaskets for proper seal. Clean, if necessary, according to the chart on page 22. Check for internal obstructions that are keeping door from closing properly (i.e. improperly closed drawers, ice buckets, oversized or improperly stored containers, etc.)	
	Controls need to be adjusted.	See pages 10-12 to adjust your controls.	
	Condenser coils are dirty.	Clean according to the chart on page 22.	
	Rear air grille is blocked.	Check the positioning of food items in refrigerator to make sure grille is not blocked. Rear air grilles are located under crisper drawers.	
	Door has been opened frequently, or has been opened for long periods of time.	Reduce time door is open. Organize food items efficiently to assure door is open for as short a time as possible.	
	Food has recently been added.	Allow time for recently added food to reach refrigerator or freezer temperature.	
	Refrigerator has an odor	Compartment is dirty or has odor-causing food.	Clean according to instructions on page 22.
	Water droplets form on outside of refrigerator	Check gaskets for proper seal.	Clean according to the chart on page 22.
Humidity levels are high.		Normal during times of high humidity.	
Controls require adjustment.		See pages 10-12 to adjust your controls.	

Troubleshooting

PROBLEM	POSSIBLE CAUSES	WHAT TO DO
Water droplets form on inside of refrigerator	<ul style="list-style-type: none"> Humidity levels are high or door has been opened frequently. 	<ul style="list-style-type: none"> See pages 10-12 to adjust your controls. Reduce time door is open. Organize food items efficiently to assure door is open for as short a time as possible.
	<ul style="list-style-type: none"> Check gaskets for proper seal. 	<ul style="list-style-type: none"> Clean, if necessary, according to the chart on page 22.
Refrigerator or ice maker makes unfamiliar sounds or seems too loud	<ul style="list-style-type: none"> Normal operation. 	<ul style="list-style-type: none"> See page 16.
Crisper drawers do not close freely	<ul style="list-style-type: none"> Contents of drawer, or positioning of items in the surrounding compartment could be obstructing drawer. 	<ul style="list-style-type: none"> Reposition food items and containers to avoid interference with the drawers.
	<ul style="list-style-type: none"> Drawer is not in proper position. 	
	<ul style="list-style-type: none"> Refrigerator is not level. 	<ul style="list-style-type: none"> See page 3 for details on how to level your refrigerator.
	<ul style="list-style-type: none"> Drawer channels are dirty or need treatment. 	<ul style="list-style-type: none"> Clean drawer channels with warm, soapy water. Rinse and dry thoroughly. Apply a thin layer of petroleum jelly to drawer channels.
Refrigerator runs too frequently	<ul style="list-style-type: none"> Doors have been opened frequently or for long periods of time. 	<ul style="list-style-type: none"> Reduce time door is open. Organize food items efficiently to assure door is open for as short a time as possible. Allow interior environment to adjust for period the door has been opened.
	<ul style="list-style-type: none"> Humidity or heat in surrounding area is high. 	<ul style="list-style-type: none"> Normal operation.
	<ul style="list-style-type: none"> Food has recently been added. 	<ul style="list-style-type: none"> Allow time for recently added food to reach refrigerator or freezer temperature.
	<ul style="list-style-type: none"> Refrigerator is exposed to heat by environment or by appliances nearby. 	<ul style="list-style-type: none"> Evaluate your refrigerator's environment. Refrigerator may need to be moved to run more efficiently.
	<ul style="list-style-type: none"> Condenser coils are dirty. 	<ul style="list-style-type: none"> Clean, if necessary, according to the chart on page 22.
	<ul style="list-style-type: none"> Controls need to be adjusted. 	<ul style="list-style-type: none"> See pages 10-12 to adjust your controls.
	<ul style="list-style-type: none"> Door is not closing properly. 	<ul style="list-style-type: none"> Refrigerator is not level. See page 3 for details on how to level your refrigerator.
		<ul style="list-style-type: none"> Check gaskets for proper seal.
		<ul style="list-style-type: none"> Clean, if necessary, according to the chart on page 22. Check for internal obstructions that are keeping door from closing properly (i.e. improperly closed drawers, ice buckets, oversized or improperly stored containers, etc.)
	<ul style="list-style-type: none"> Normal Operation 	<ul style="list-style-type: none"> See <i>Operating Sounds</i> on page 26.

Troubleshooting

Ice and Water

PROBLEM	POSSIBLE CAUSES	WHAT TO DO
Refrigerator is leaking water	<ul style="list-style-type: none"> Plastic tubing was used to complete water connection. 	<ul style="list-style-type: none"> The manufacturer recommends using copper tubing for installation. Plastic is less durable and can cause leakage. The manufacturer is not responsible for property damage due to improper installation or water connection.
	<ul style="list-style-type: none"> Improper water valve was installed. 	<ul style="list-style-type: none"> Check water connection procedure (see pages 8-9). Self-piercing and 3/16" saddle valves cause low water pressure and may clog the line over time. The manufacturer is not responsible for property damage due to improper installation or water connection.
Ice forms in inlet tube to ice maker	<ul style="list-style-type: none"> Water pressure is low. 	<ul style="list-style-type: none"> Water pressure must be between 35 to 100 pounds per square inch to function properly. A minimum pressure of 35 pounds per square inch is recommended for refrigerators with water filters.
	<ul style="list-style-type: none"> Freezer temperature is too high. 	<ul style="list-style-type: none"> Adjust freezer control (see page 10). Freezer is recommended to be approximately 0° F (-18° C).
Water flow is slower than normal	<ul style="list-style-type: none"> Water pressure is low. 	<ul style="list-style-type: none"> Water pressure must be between 35 to 100 pounds per square inch to function properly. A minimum pressure of 35 pounds per square inch is recommended for refrigerators with water filters.
	<ul style="list-style-type: none"> Improper water valve was installed. 	<ul style="list-style-type: none"> Check water connection procedure in your Installation Instructions. Self-piercing and 3/16" saddle valves cause low water pressure and may clog the line over time. The manufacturer is not responsible for property damage due to improper installation or water connection. Open water valve completely and check for leaks.
	<ul style="list-style-type: none"> Copper tubing has kinks. 	<ul style="list-style-type: none"> Turn off water supply and remove kinks. If kinks cannot be removed, replace tubing.
	<ul style="list-style-type: none"> Water filter is clogged or needs to be changed. 	<ul style="list-style-type: none"> Change water filter (see page 17).