

Service

This manual is to be used by qualified appliance technicians only. Maytag does not assume any responsibility for property damage or personal injury for improper service procedures done by an unqualified person.

This Base Manual covers general information
Refer to individual Technical Sheet
for information on specific models

This manual includes, but is
not limited to the following:

JDR8895AAB/S/W
JDR8895ACS/W

Freestanding Double Oven Dual Fuel Range

Important Information

Pride and workmanship go into every product to provide our customers with quality products. It is possible, however, that during its lifetime a product may require service. Products should be serviced only by a qualified service technician who is familiar with the safety procedures required in the repair and who is equipped with the proper tools, parts, testing instruments and the appropriate service information. **IT IS THE TECHNICIANS RESPONSIBILITY TO REVIEW ALL APPROPRIATE SERVICE INFORMATION BEFORE BEGINNING REPAIRS.**

Important Notices for Servicers and Consumers



WARNING

To avoid risk of severe personal injury or death, disconnect power before working/servicing on appliance to avoid electrical shock.

To locate an authorized servicer, please consult your telephone book or the dealer from whom you purchased this product. For further assistance, please contact:

Customer Service Support Center

CAIR Center

<u>Web Site</u>	<u>Telephone Number</u>
WWW.JENNAIR.COM	1-800-688-1100
CAIR Center in Canada	1-800-688-2002

Recognize Safety Symbols, Words, and Labels



DANGER

DANGER—Immediate hazards which **WILL** result in severe personal injury or death.



WARNING

WARNING—Hazards or unsafe practices which **COULD** result in severe personal injury or death.



CAUTION

CAUTION—Hazards or unsafe practices which **COULD** result in minor personal injury, product or property damage.

Table of Contents

Important Information	2	Disassembly Procedures	
Safety Information		Moving and/or Replacing Range	21
Safety Practices for Servicer	4	Leveling Legs	21
Servicing	4	Anti-Tip Bracket	21
Connecting Range to Gas	5	Top Burner	21
Electrical Requirements	5	Side Panel	21
Extension Cord	5	Maintop Removal	21
Receiving Oven	5	Top Surface Valve and Spark Switch	21
Using the Oven	5	Top Burner Lower Assembly	21
Baking, Broiling, and Roasting	6	Manifold and Top Burner	21
Precautions	6	Bake Element	22
Product Safety Devices	6	Broil Element	22
General Information		Oven Sensor	22
Cooking Nomenclature	7	Electronic Clock	22
Specifications	8	Oven Light Replacement	22
Placement of the Oven	8	Oven Door(s)	
Location of Model Number	8	Door Removal	23
Model Identification	8	Door Replacement	23
Service	8	Gasket and Door Disassembly	23
Parts and Accessories	8	Lower Latch Assembly	24
Extended Service Plan	8	Upper Latch Assembly	25
Range Description	9	Oven Door Hinge	26
Troubleshooting Procedures		Regulator	26
Control Systems Troubleshooting	10	Spark Module	26
Component Troubleshooting	13	Rovker Switch	26
Testing Procedures		Indicator Lamps	26
Component Testing	16	Hi-Limit Thermostat	27
H2.5 Oven Control Testing	18	Door Plunger	27
Quick Test Mode	19	Infinite Switch	27
		Convection Assembly	27
		Oven Racks	27
		Rack Positions	27
		Multiple Rack Cooking	27
		Oven Cavity Components (Electric)	28
		Appendix A	
		Installation Instructions	A-2
		Appendix B	
		Use and Care	B-2
		Cleaning Procedures	B-15
		Appendix C	
		LP Conversion	C-2

Important Safety Information

Recognize this symbol as a safety precaution.



WARNING

If the information in this manual is not followed exactly, a fire or explosion may result causing property damage, personal injury or death.

There can be a risk of injury or electrical shock while performing services or repairs. Injury or electrical shock can be serious or even fatal. Consequently, extreme caution should be taken when performing voltage checks on individual components of a product. The electrical power supply should ALWAYS be disconnected when servicing a product.

Do not store or use gasoline or other flammable vapors or liquids in the vicinity of this or any other appliance.

WHAT TO DO IF YOU SMELL GAS

- Extinguish any open flame.
- Do not try to light any appliance.
- Do not touch any electrical switch; do not use any phone in your building.
- Immediately call your gas supplier from a neighbor's phone. Follow the gas supplier's instructions.
- If you cannot reach your gas supplier, call the fire department.

Installation and service must be performed by an authorized installer, service agency or gas supplier.

This appliance must be properly grounded. Never plug in or direct-wire an appliance unless it is properly grounded and in accordance with all local and national codes. See "Installation Instructions" that accompany the product for the appropriate grounding procedures.

WARNING

To avoid risk of electrical shock, property damage, personal injury or death; verify wiring is correct, if components were replaced. Verify proper and complete operation of unit after servicing.

This appliance contains or produces a chemical or chemicals which are known to the state of California to cause cancer, birth defects or other reproductive harm. To reduce the risk from substances in the fuel or from fuel combustion make sure this appliance is installed, operated, and maintained according to the instructions in this manual.

WARNING

Due to the nature of cooking, fires can occur as a result of overcooking or excessive grease. Although a fire is unlikely, if one occurs proceed as follows:

Oven Fires

1. Do not open the oven door.
2. Turn all controls to the OFF position.
3. As an added precaution turn off the electricity at the main circuit breaker or fuse box and the gas at the main supply valve.
4. Allow the food or grease to burn itself out in the oven.

If smoke or fire persist call the local fire department.

To avoid risk of property damage or personal injury do not obstruct the flow of combustion or ventilation air to the oven.

To avoid risk of electrical shock, serious personal injury or death: Verify the oven has been properly grounded and always disconnect the electrical supply before servicing this unit.

NOTE: The maximum gas supply pressure for these models must not exceed 14 inches W.C.P.

Safety Practices for Servicer

Safe and satisfactory operation of dual fuel ranges depends upon its design and proper installation.

Servicing

Listed below are some general precautions and safety practices which should be followed in order to protect the service technician and consumer during service and after service has been completed.

1. **Gas smell**—Extinguish any and all open flames and open windows.
2. **Turn gas off**—Service range with gas turned off unless testing requires it.
3. **Checking for gas leaks**—Never check for leaks with any kind of open flame. Soap and water solution should be used for this purpose. Apply solution to suspected area and watch for air bubbles which indicates a leak. Correct leaks by tightening fittings, screws, connections, applying approved compound, or installing new parts.
4. **Using lights**—Use a hand flashlight when servicing ranges or checking for gas leaks. Electric switches should not be operated where leaks are suspected. This will avoid creating arcing or sparks which could ignite the gas. If electric lights are already turned on, they should not be turned off.

Important Safety Information

5. **Do not smoke**—Never smoke while servicing gas ranges, especially when working on piping that contains or has contained gas.
 6. **Check range when service is completed**—After servicing, make visual checks on electrical connection, and check for gas leaks. Inform consumer of the condition of range before leaving.
 7. **Adhere to all local regulations and codes when performing service.**
- Ensure range is correctly adjusted by a qualified service technician or installer for the type of gas (Natural or LP). Some ranges can be converted for use with Natural or LP gas.
 - With prolonged use of a range, high floor temperatures could result. Many floor coverings will not be able to withstand this kind of use. Never install range over vinyl tile or linoleum that cannot withstand high temperatures. Never install range directly over carpeting.

Listed below are some general precautions and safety practices which should be followed in order to protect the service technician and consumer during service and after service has been completed.

1. **Check range when service is complete**—After servicing, make visual checks on electrical and gas connection. Inform consumer of the condition of range before leaving.
2. **Adhere to all local regulations and codes when performing service.**

Connecting Range to Gas

Install manual shut-off valve in gas line for easy accessibility outside range. Be aware of the location of the shut-off valve.

Electrical Requirements

120-volt, 60 Hertz, 15 amp, individual circuit which is properly grounded, polarized and protected by a circuit breaker or fuse.

Extension Cord

Due to possible pinching during installation, extension cords should not be used on products.

Extension cords will adversely affect the performance of spark system.

Receiving Oven

- Installer needs to show consumer location of the range gas shut-off valve and how to shut it off.
 - Authorized servicer must install the range, in accordance with the Installation Instructions. Adjustments and service should be performed only by authorized servicer.
 - Plug range into a 120-volt grounded outlet only. Do not remove round grounding prong from the plug. If in doubt about grounding of the home electrical system, it is consumers responsibility and obligation to have an ungrounded outlet replaced with a properly grounded three-prong outlet in accordance with the National Electrical Code. Do not use an extension cord with this appliance.
 - Insure all packing materials are removed from the range before operating it, to prevent fire or smoke damage should the packing material ignite.
- Do not leave children alone or unattended where a range is hot or in operation. They could be seriously burned.
 - Do not allow anyone to climb, stand or hang on the door. They could damage the range and cause severe personal injury.
 - Wear proper apparel. Loose fitting or hanging garments should never be worn when using oven. Flammable material could ignite if brought in contact with flame or hot oven surfaces which may cause severe burns.
 - Never use range for warming or heating a room. This may cause burns, injuries, or a fire.
 - Do not use water on grease fires.
 - Do not let grease or other flammable materials collect in or around range.
 - Do not repair or replace any part of range unless it is recommended in this manual.
 - Use only dry potholders. Moist or damp potholders used on hot surfaces may result in a burn from steam. Do not let a potholder touch the flame. Do not use a towel or a bulky cloth as a potholder.
 - Never leave range unattended while cooking. Boilovers can cause smoking and may ignite.
 - Only certain types of glass/ceramic, earthenware, or other glazed utensils are suitable for oven use. Unsuitable utensils may break due to sudden temperature change.
 - Use care when opening oven door. Let hot air or steam escape before removing or replacing food.
 - Do not heat unopened food containers in oven. Buildup of pressure may cause a container to burst and result in injury.
 - Keep range vent ducts unobstructed.
 - Place oven racks in desired location while oven is cool. If a rack must be moved while oven is hot, use a dry potholder.
 - Do not use aluminum foil to line oven bottom or racks. Aluminum foil can cause a fire and will seriously affect baking results, and damage to porcelain surfaces.
 - Do not touch interior surfaces of oven during or immediately after use. Do not let clothing or other flammable materials come in contact with bake or broil burners.

Using the Oven

Important Safety Information

- Other areas of the oven can become hot enough to cause burns, such as vent openings, window, oven door and oven racks.
- To avoid steam burns, do not use a wet sponge or cloth to wipe up spills on hot cooking area.
- Do not store combustible or flammable materials, such as gasoline or other flammable vapors and liquids near or in oven.
- Do not clean oven door gasket located on back of the door. Gasket is necessary to seal the oven and can be damaged as a result of rubbing or being moved.
- Do not drape towels or any materials on oven door handles. These items may ignite causing a fire.

Baking, Broiling, and Roasting

- Do not use oven area for storage.
- Stand back from range when opening a hot oven door. Hot air or steam can cause burns to hands, face, and eyes.
- Use only glass cookware appropriate for use in electric ovens.
- Always remove broiler pan from oven when finished broiling. Grease left in pan can catch fire if oven is used without removing grease from the broiler pan.
- Make sure broiler pan is placed correctly to reduce any possibility of grease fires.
- Should a grease fire occur in the broiler pan, turn off oven, and keep oven door closed until fire burns out.

Precautions

- Do not cook food directly on range top surface, always use cookware.
- Do not mix household cleaning products. Chemical mixtures may interact with hazardous results.
- Do not put plastic items on warm cooking areas.
- Do not slide rough objects across range top surface.
- Do not leave fat heating unless you remain nearby. Fat can ignite if overheated by spilling onto hot surfaces.
- Do not allow pots to boil dry as this can cause damage to cooking surface and pan.
- Do not use range top surface as a cutting board.

Product Safety Devices

Safety devices and features have been engineered into the product to protect consumer and servicer. Safety devices must never be removed, bypassed, or altered in such a manner as to defeat the purpose for which they were intended.

Listed below are various safety devices together with the reason each device is incorporated in the gas ranges.

Pressure Regulator

Maintains proper/steady gas pressure oven controls. Regulator must be set for the type of gas being used, either **Natural** or **LP**.

After servicing regulator, make certain it is set properly before completing service.

Universal orifices are used on most valves. They must be adjusted or set for the type of gas being used **Natural** or **LP**.

After servicing a valve or orifice verify it is adjusted properly before completing service.

Gas Burner Orifices

Grounded Oven Frame

Ground prong on power cord is connected to the frame, usually a green lead fastened by a screw. In addition, any part or component capable of conducting an electric current is grounded by its mounting.

If any ground wire, screw, strap, nut, etc. is removed for service, or any reason, it must be reconnected to its original position with original fastener before the appliance is put into operation again.

Failure to do so can create a possible shock hazard.

General Information

This manual provides basic instructions and suggestions for handling, installing and servicing dual fuel ranges.

The directions, information, and warnings in this manual are developed from experience with, and careful testing of the product. If the unit is installed according to this manual, it will operate properly and will require minimal servicing. A unit in proper operating order ensures the consumer all the benefits provided by clean, modern electric and gas cooking.

This manual contains information needed by authorized service technicians to install and service dual fuel ranges.

There may be, however, some parts which need further explanation. Refer to the Installation Instructions, Use and Care, Technical Sheets or the toll-free technical support line.

Cooking Nomenclature

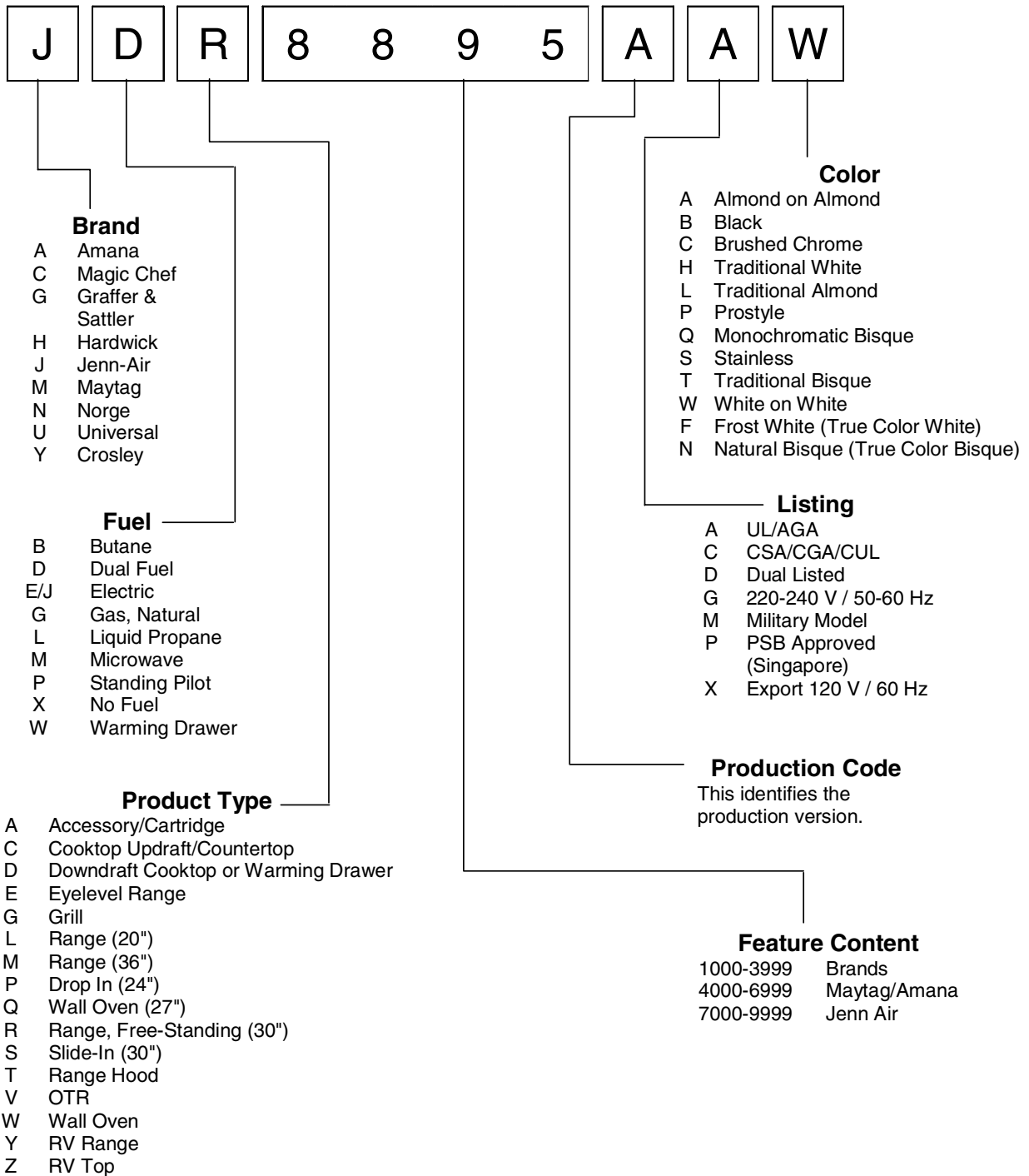

General Information

Specifications

Refer to individual Technical Sheet for specification information.

Placement of the Oven

This freestanding range must be placed in the kitchen or comparable room. All safety guidelines must be followed (see Chapter 2) and free air flow around the range is essential.

Do Not Block Air Vents

All air vents must be kept clear during cooking. If air vents are covered during operation, the oven may overheat. If this occurs, a sensitive, thermal safety device automatically removes power to the oven, rendering the oven inoperable. The oven will remain in this state until it has sufficiently cooled.

Location of Model Number

To request service information or replacement parts, the service center will require the complete model, serial, and manufacturing number of your freestanding range. The number can be found on a metal tag located on the back of the control panel. Reach behind the top left corner of the control panel and rotate the tags up to view the data.

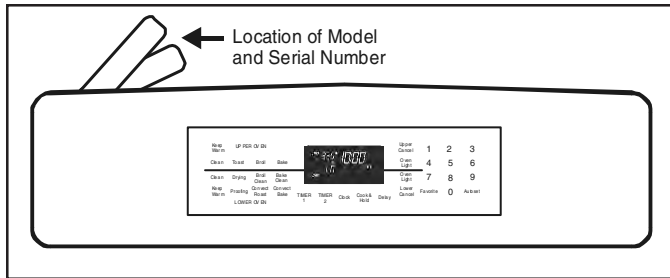

Model Identification

Complete enclosed registration card and promptly return.

If registration card is missing:

- For Jenn-Air product call 1-800-688-1100 or visit the Web Site at www.jennair.com
- For product in Canada call 1-866-587-2002 or visit the Web Site at www.jennair.com

When contacting provide product information located on rating plate. Record the following:

Model Number: _____
Manufacturing Number: _____
Serial or S/N Number: _____
Date of purchase: _____
Dealer's name and address: _____

Service

Keep a copy of sales receipt for future reference or in case warranty service is required. To locate an authorized servicer:

- For Jenn-Air product call 1-800-688-1100 or visit the Web Site at www.jennair.com
- For product in Canada call 1-866-587-2002 or visit the Web Site at www.jennair.com

Warranty service must be performed by an authorized servicer. We also recommend contacting an authorized servicer, if service is required after warranty expires.

Parts and Accessories

Purchase replacement parts and accessories over the phone. To order accessories for your product call:

- For Jenn-Air product call 1-800-688-1100 or visit the Web Site at www.jennair.com
- For product in Canada call 1-866-587-2002 or visit the Web Site at www.jennair.com

Extended Service Plan

We offer long-term service protection for this new oven.

- Dependability PlusSM Extended Service Plan is specially designed to supplement Jenn-Air's strong warranty. This plan covers parts, labor, and travel charges.

Call 1-800-925-2020 for information.

Range Description

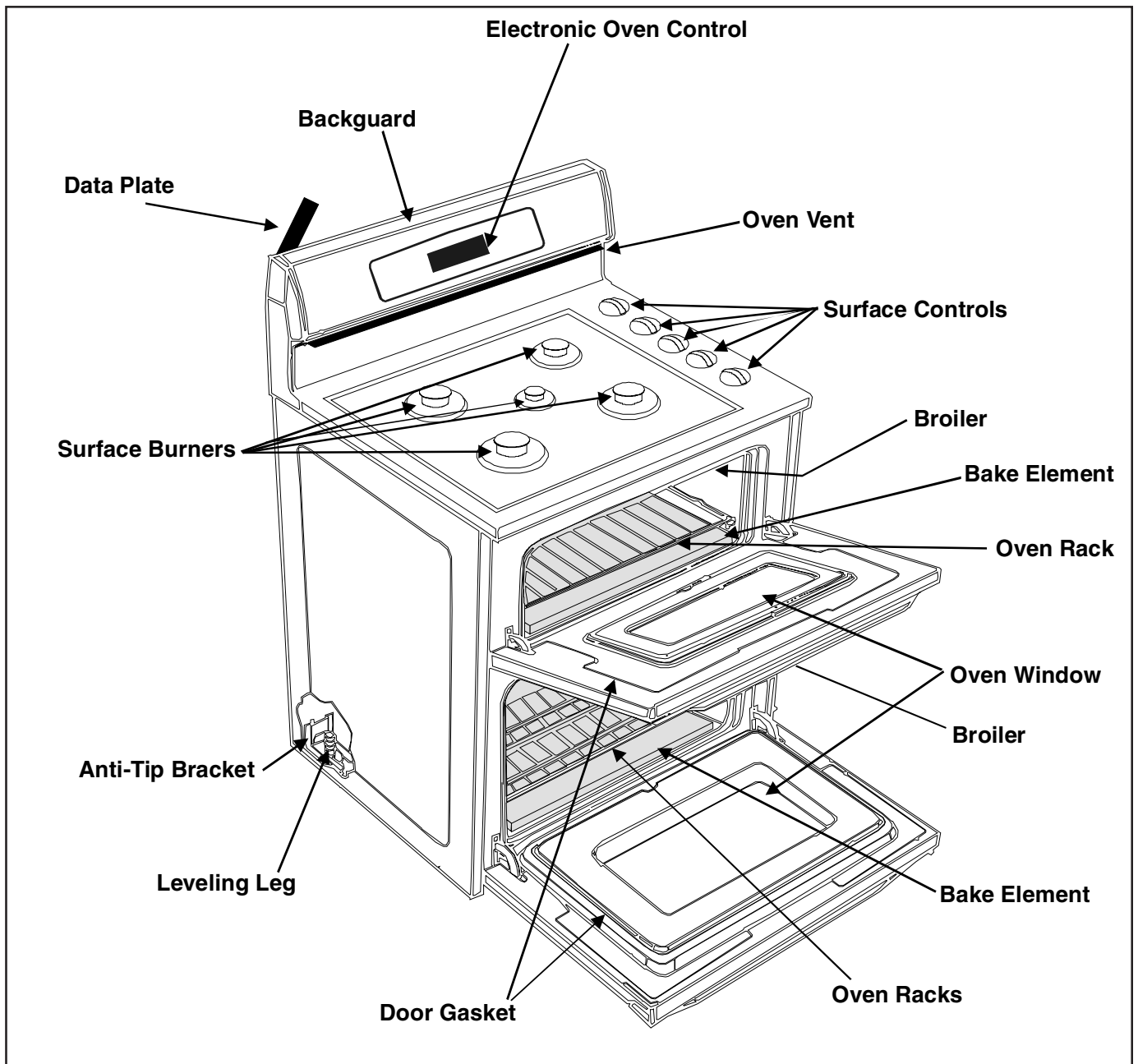

Troubleshooting Procedures



WARNING

To avoid risk of electrical shock, personal injury or death; disconnect power and gas to oven before servicing, unless testing requires power and/or gas.



CAUTION

- Verify proper grounding before checking for trouble.
- Be careful of the high voltage circuit.
- Discharge the high voltage capacitor.
- When checking the continuity of the switches or of the high voltage transformer, disconnect one lead wire from these parts and then check continuity with the AC plug removed. To do otherwise may result in a false reading or damage to your meter.
- Do not touch any part of the circuit on the printed circuit board, since static electric discharge may damage the control panel. Always touch yourself to ground while working on this panel to discharge any static charge built up on your body.

Control Systems Troubleshooting

Description of Error Codes

The Diagnostic Code Display Mode allows viewing of the error diagnostic codes.

Each error code consists of four digits. The following table describes the function of each digit.

Digit	Description
1 st	Primary System: 1 – Local to the control circuit board 3 – Sensor or meat probe 4 – Control input 9 – Door lock
2 nd	Measurable: d – Diagnostic: measurable parameter c – Control related, replace control
3 rd	Secondary System: Sequential numbering
4 th	Oven Cavity: 1 – Upper oven (or single cavity oven) 2 – Lower oven c – Control specific

Diagnostic Code Display Mode may be activated by **pressing and holding** the *AUTOSET* pad for 3 seconds at power-up. **Diagnostic Code Display Mode may be entered only when applying power to the control.**

Troubleshooting Procedures



WARNING

To avoid risk of electrical shock, personal injury or death; disconnect power and gas to oven before servicing, unless testing requires power and/or gas.

Diagnostic Code Checking

Code	Description	When Checked	Detection
1c1c	Shorted key	Always	1 minute
1c2c	Keyboard tail disconnected	Always	1 minute
1c31	Cancel key circuit problem	Always	20 seconds
1c32	Cancel key circuit problem	Always	20 seconds
1c6c	EEPROM error	When accessing EEPROM	3 tries
1c7c	Control not calibrated	Always	3 tries
1c8c	Cooking program error	Cook or clean programmed	3 tries
1d11	Runaway temp (650°F), door unlocked	Latch unlocked	1 minute
1d12	Runaway temp (650°F), door unlocked	Latch unlocked	1 minute
1d21	Runaway temp (950°F), door locked	Latch locked	1 minute
1d22	Runaway temp (950°F), door locked	Latch locked	1 minute
3d11	Sensor open	Cook or clean active	20 seconds
3d12	Sensor open	Cook or clean active	20 seconds
3d21	Sensor shorted	Cook or clean active	20 seconds
3d22	Sensor shorted	Cook or clean active	20 seconds
4d11	Door switch position failure	Clean or keyboard Lockout active	1 minute
4d12	Door switch position failure	Clean or keyboard Lockout active	1 minute
4d21	No reverse airflow fan rotation (no/low RPM)	Clean or Cook programmed	1 minute
4d31	Reverse airflow fan state (on when should be off)	Suppose to be OFF	1 minute
4d51	Door switch circuit failure	Convect, Clean or Keyboard Lockout programmed	1 minute
4d52	Door switch circuit failure	Convect, Clean or Keyboard Lockout programmed	1 minute
9d11	Latch will not lock	Latch should be locked	See Note ⁶
9d12	Latch will not lock	Latch should be locked	See Note ⁶
9d21	Latch will not unlock	Latch should be unlocked	See Note ⁶
9d22	Latch will not unlock	Latch should be unlocked	See Note ⁶
9d31	Latch state unknown, both locked and unlocked	Latch should be locked or when lock attempted	See Note ⁶
9d32	Latch state unknown, both locked and unlocked	Latch should be locked or when lock attempted	See Note ⁶

Diagnostic Code Handling

Code	Measurable	What is Displayed	Action Taken By Control
1c1c	Keypress	Nothing	Disables audible for affected key depression Disables all outputs ^{1, 2} Disables lights and timers
1c2c	Keyboard loop improper value	Nothing	Disables audible for key depression Disables all outputs ¹ Disables lights and timers
1c31	Cancel key improper value	BAKE flashes ³	Disables all outputs for cavity ¹
1c32	Cancel key improper value	BAKE flashes ³	Disables all outputs for cavity ¹
1c6c	No response from EEPROM	Nothing	Disables all outputs ¹
1c7c	Calibration value out of range	"CAL" in the time digits	Completely disables oven ⁴
1c8c	CRC invalid	Nothing	Cancels active cook function
1d11	Sensor resistance > 2237 Ω	BAKE flashes ³	Disables all cook function for cavity
1d12	Sensor resistance > 2237 Ω	BAKE flashes ³	Disables all cook function for cavity
1d21	Sensor resistance > 2787 Ω	BAKE flashes ³	Disables all cook function for cavity
1d22	Sensor resistance > 2787 Ω	BAKE flashes ³	Disables all cook function for cavity
3d11	Sensor resistance > Infinite Ω	BAKE flashes ³	Disables all cook function for cavity
3d12	Sensor resistance > Infinite Ω	BAKE flashes ³	Disables all cook function for cavity
3d21	Sensor resistance > 0 Ω	BAKE flashes ³	Disables all cook function for cavity
3d22	Sensor resistance > 0 Ω	BAKE flashes ³	Disables all cook function for cavity
4d11	Door switch not closed when door is locked	Nothing	Disables Clean and Lockout functions ⁵
4d12	Door switch not closed when door is locked	Nothing	Disables Clean and Lockout functions ⁵
4d21	No reverse airflow fan rotation (no/low RPM)	Nothing	Disables all cook function for cavity
4d31	Reverse airflow fan state (on when should be off)	Nothing	No action
4d51	Door switch not open or closed	Nothing	Disables Convect, Clean, and Lockout functions ^{4, 5} Turn off light and disable light from door switch
4d52	Door switch not open or closed	Nothing	Disables Convect, Clean, and Lockout functions ^{4, 5} Turn off light and disable light from door switch
9d11	Lock switch not closed	LOCK flashes ³	Disables Clean and Lockout functions ⁴
9d12	Lock switch not closed	LOCK flashes ³	Disables Clean and Lockout functions ⁴
9d21	Unlock switch not closed	LOCK flashes ³	Disables Clean and Lockout functions ⁴
9d22	Unlock switch not closed	LOCK flashes ³	Disables Clean and Lockout functions ⁴
9d31	Latch both locked and unlocked	LOCK flashes ³	Disables Clean and Lockout functions ⁴
9d32	Latch both locked and unlocked	LOCK flashes ³	Disables Clean and Lockout functions ⁴

Troubleshooting Procedures



WARNING

To avoid risk of electrical shock, personal injury or death; disconnect power and gas to oven before servicing, unless testing requires power and/or gas.

NOTES:

- 1 "Action Taken" applies as long as the condition exists. If the condition goes away, the control recovers.
- 2 If there is a cook function or timer active, the function continues. The user cannot edit the function, and [Cancel] will cancel the cook mode.
- 3 Flash rate: 0.2 seconds on, 0.1 second off. Pressing any key will clear the display until the fault clears and is re-triggered.
- 4 "Action Taken" applies until there is a POR (Power On Reset ["hard reset"]).
- 5 If the control believes the door is locked, it will attempt to unlock it when the function cancels and the cavity temperature cools.
- 6 Special conditions for latch faults (9dxx):
 - A known good **unlock** position is defined as when the unlock switch reads closed and lock switch reads open.
 - A known good **lock** position is defined as when the unlock switch reads open and lock switch reads closed.
 - A **faulted switch** means the switch input is reading an invalid state, neither open nor closed.
 - Once a latch fault occurs, latch movement is disabled until there is a POR. An error tone will sound if a function requiring a faulted latch is attempted.
 - If at POR, the latch is not at a known good unlock position:
 - If the latch is at a good lock position, it will attempt to unlock when the RTD (Resistance Temperature Device) temperature is below 400°F.
 - If the latch is not at a good lock position, the control will fault.
 - If a latch fault occurs while the RTD is above the lock temperature, the latch will not try to move, but the fault is still logged to EEPROM after the first stage of detection.
 - The Display column for latch faults applies 1) If the latch was moving when the fault occurred; 2) If the latch is already in a known locked state when the fault occurs.
 - LOCK flashes after a fault is detected and until the unlocked position is achieved. The unlock position may be identified by a successful unlock switch closure, or as the result of timing when the unlock switch is not functioning properly.
 - If the last known good position was unlock (e.g. baking, or idle) and a latch fault occurs, the motor is never moved. The fault is logged to EEPROM and is not seen by the user.
 - Latch fault detection is in two stages. The first stage is to allow the control to recover without moving the latch. After this:
 - If the latch was previously at a known good unlock position, the latch will not move and the control will fault.
 - If the control was previously in a known good lock position:
 - If the RTD is below 400°F, the latch will attempt to recover to its proper position (up to three revolutions). If it cannot, the control will fault and the latch will move to a calculated unlock position.
 - If the RTD is at or above 400°F, the control will fault. When the RTD cools to below 400°F, the control will attempt to recover to a good unlock position (up to three revolution). If it cannot, the control will fault and the latch will move to a calculated unlock position.
 - **Note:** If the unlock position cannot be found, this may result in a second fault, the first fault occurring when the latch request was locked, and the second when the latch request is unlocked.
 - If the latch is moving when the fault occurs, the control will bypass the first stage of detection and immediately try to find its proper position. If it cannot, the control will fault and the latch will move to a calculated unlock position.
 - Affected DLBs (Double Line Breaks) and loads are disabled during detection.
 - If the control is in a known good unlock position and the lock switch becomes faulted:
 - The control will not fault.
 - If a function requiring latch movement is attempted while the lock switch is faulted, the control will sound an error tone and the function will be disabled.
 - If the control is in a known good lock position and the unlock switch becomes faulted:
 - The control will not fault.
 - After the function is canceled and unlock is attempted, the control will attempt to unlock the latch according to the procedures in these notes.

Troubleshooting Procedures



WARNING

To avoid risk of electrical shock, personal injury or death; disconnect power and gas to oven before servicing, unless testing requires power and/or gas.

Component Troubleshooting

Problem	Possible Cause	Correction
Part or all of the appliance does not work	Power Outage..... Improperly set oven controls Oven door locked Delayed cooking/cleaning.....	<ul style="list-style-type: none"> • Check power supply/circuit breaker • Verify oven controls are properly set • Verify oven door is unlocked after a self-clean cycle • Verify oven is not set for delayed cooking or cleaning program
Burners will not ignite; no spark at top burner.	Poor ground on burner cap..... Weak or failed spark module..... Low gas pressure	<ul style="list-style-type: none"> • Clean burner cap. • Replace spark module. • Verify pressure 4" WCP for natural, 10" WCP for LP.
Burner will not ignite. No spark to burner ignitors when burner knob is rotated to "LITE" position.	No 120 VAC to range Micro switch contacts not closing Faulty wiring. Bad connection at burner electrode and electrode socket..... Inoperative spark module	<ul style="list-style-type: none"> • Verify voltage at wall outlet. • Check wiring against appropriate wiring diagram, Verify all terminals and connections are correct and tight. Check micro switch contacts. • Check wiring against appropriate wiring diagram. Verify all terminals and connections are correct and tight. • Check module according to testing procedures information. • Clean electrode or burner cap. • Replace electrode.
No spark or only random spark at one ignitor.	Check for cracked ignitor or pinched ignitor wire Poor continuity to burner cap..... Bad ground connection or lack of continuity to ground or ignitor	<ul style="list-style-type: none"> • Replace ignitor lead or electrode. • Clean burner cap and lead. • Tighten ground connection and correct any breaks in ground path from ignitor path to unit ground path. • Replace ignitor lead.
Unit continues to spark after knob is turned to OFF position.	Shorted valve switch/harness..... Switch has slipped off the valve	<ul style="list-style-type: none"> • Replace switch/harness. If shorting is caused by excessive spillovers, customer education is advised. • Carefully reposition switch on valve and rotate from OFF to high, several times to verify switch is not broken.

Troubleshooting Procedures



WARNING

To avoid risk of electrical shock, personal injury or death; disconnect power and gas to oven before servicing, unless testing requires power and/or gas.

Problem	Possible Cause	Correction
Oven elements fail to operate or heat food.	No Power Improperly set oven controls	<ul style="list-style-type: none"> • Check to be sure plug is securely inserted into receptacle. Check or re-set circuit breaker. Check or replace fuse. Check power supply. • Ensure oven controls have been properly set. Ensure oven is not set for a delayed oven operation. Upper oven in a toasting operation. Lower oven will operate when the toasting operation finishes.
No oven operation in bake or broil.	No voltage to control..... No voltage from control Loose wire connection or broken wire	<ul style="list-style-type: none"> • Check for 120 VAC at control. If no voltage check power source. • Check 120 VAC to ignitor, if no voltage, replace control. • Verify all connections are clean and tight, replace broken wire.
Broil element shuts off shortly after the start of self-clean operation. Bake and broil functions operate normally.	Power outage..... Control Error	<ul style="list-style-type: none"> • Verify power is present at unit. Verify that the circuit breaker is not tripped. • Replace household fuse, but do not fuse capacity. • See "Control Systems Troubleshooting."
No gas flows to burner. Ignitor glows red.	Failed ignitor. Gas pressure too high Failed gas valve Loose wire connection or broken wire	<ul style="list-style-type: none"> • Check ignitor current draw, 3.2 – 3.6 Amps. Replace ignitor, if it fails test. • Check for correct gas pressure. Natural gas pressure should be 4" WCP and LP gas pressure should be 10" WCP. • Check gas valve for continuity. • Verify all connections are clean and tight, replace broken wire.
Fan motor does not operate.	No power to fan motor Failed fan motor or winding/frozen shaft	<ul style="list-style-type: none"> • Check for 120 VAC supplied at fan motor. If no voltage is present, check for broken or loose wiring between fan motor and relay board. If voltage is present at fan motor, go to the next step. • Check motor winding for continuity. Check for a frozen motor shaft. Check for broken wiring between motor and neutral terminal block.

Troubleshooting Procedures



WARNING

To avoid risk of electrical shock, personal injury or death; disconnect power and gas to oven before servicing, unless testing requires power and/or gas.

Problem	Possible Cause	Correction
Oven light does not operate.	Failed oven lamp Failed wiring..... Failed light socket..... Failed light plunger/switch	<ul style="list-style-type: none"> • Check lamp and replace is necessary. • Check for broken, loose or dirty connections. • Check light socket for continuity. • Check plunger/switch for continuity. Check wiring diagram for application.
Self-clean cycle not working	Programming error	<ul style="list-style-type: none"> • Shut off power to oven for five minutes by switching off circuit breaker. Reset circuit breaker and try oven again.
Oven door will not unlock	Oven is self-cleaning Oven is still hot	<ul style="list-style-type: none"> • Allow cycle to complete. • Door will not unlock until unit has cooled to safe temperature. Do not force door open, this will void warranty. Blow cool air on door latch area to quicken process.
Oven smokes/odor first few times of usage	Normal	<ul style="list-style-type: none"> • Minor smoking and/or odor is normal the first few times of oven usage. • Ventilate area well and perform self-clean cycle.
Failure Codes	Electronically Controlled	<ul style="list-style-type: none"> • See Testing Procedures for diagnostic checks.







Testing Procedures

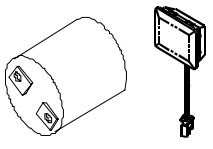
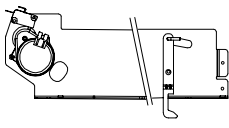
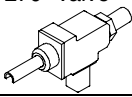

WARNING

To avoid risk of electrical shock, personal injury or death; disconnect power and gas to oven before servicing, unless testing requires power and/or gas.

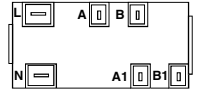
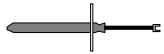
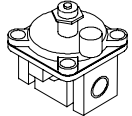
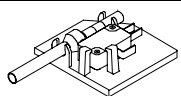
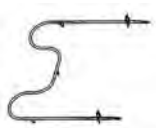
Component Testing

Illustration	Component	Test Procedure	Results
	Oven light socket	Remove one wire from receptacle and test resistance of terminals..... Measure voltage at oven light.....	Indicates continuity with bulb screwed in. 120 VAC, see wiring diagram for terminal identification. If no voltage is present at oven light, check wiring or light switches.
	Autolatch assembly with switch	Disconnect wires and test for continuity per wiring diagram. Refer to Parts Manual for correct autolatch switch associated with the correct manufacturing number.	See wiring diagram for schematic layout. Access assembly by removing left side panel.
5 K btu 9.2 K btu (2) 16 K btu 12 K btu	270° valve 	Verify gas is supplied. Adjust set screw for simmer control.	
	Spark 270° switch	Test for voltage at terminals	120 VAC
		Disconnect wiring and check for continuity in LITE position.....	Continuity in LITE position.
	Spark ignition electrode	Test for resistance of spark lead	Continuity
		Test ignitor to chassis.....	No continuity from ignitor to chassis.
5 K btu 9.2 K btu (2) 16 K btu 12 K btu	Top surface burner 	Verify gas is supplied	Check for obstructions in burner ports.
		Verify burner cap is positioned correctly.	
	Spark module 4 + 0	Test for voltage at terminals L and N Check polarity and ground.....	120 VAC See wiring diagram
	Temperature sensor	Measure resistances	Approximately 1100 Ω at room temperature 75°F.
	Pressure regulator	Verify gas pressure (W.C.P.). If on LP service verify proper gas supply conversion.	5" Natural 10" LP/propane
	Door plunger switch	Remove switch from unit and measure the following points: C NO.....	Plunger in infinite, Plunger out continuity.
	Bake element, Upper	Disconnect wire leads to element and measure resistance of terminals Measure voltage at bake element.....	Approximately 31.0 Ω , if not replace. 240 VAC, see wiring diagram for terminal identification. If no voltage is present at bake element check wiring.
	Bake element, Lower	Disconnect wire leads to element and measure resistance of terminals Measure voltage at bake element.....	Approximately 21.3 Ω , if not replace. 240 VAC, see wiring diagram for terminal identification. If no voltage is present at bake element check wiring.
	Broil element, Upper	Disconnect wire leads to element and measure resistance of terminals Measure voltage at broil element.....	Approximately 25.4 Ω , if not replace. 240 VAC, see wiring diagram for terminal identification. If no voltage is present at broil element check wiring.

Testing Procedures



WARNING

To avoid risk of electrical shock, personal injury or death; disconnect power and gas to oven before servicing, unless testing requires power and/or gas.

H2.5 Control Testing

H2.5 Controlled	Oven temperature adjustment (Upper Oven)	Press Upper Bake pad. Enter 550 on the digit-pad. Immediately press and hold Upper Bake pad for 3 seconds. Adjust oven from -35° to +35° (-37.2° to + 1.6° C) in 5° F (2.7° C) increments by pressing Autoset pad. To avoid over adjusting the oven, move temperature 5° F (2.7° C) each time. Wait 4 seconds for the data entry timer to expire to accept the change. Temperature adjustment is retained even through a power failure.	While increasing or decreasing oven temperature, this does not affect self-cleaning temperature.
H2.5 Controlled	Oven temperature adjustment (Lower Oven)	Press Lower Bake pad. Enter 550 on the digit-pad. Immediately press and hold Lower Bake pad for 3 seconds. Adjust oven from -35° to +35° (-37.2° to + 1.6° C) in 5° F (2.7° C) increments by pressing Autoset pad. To avoid over adjusting the oven, move temperature 5° F (2.7° C) each time. Wait 4 seconds for the data entry timer to expire to accept the change. Temperature adjustment is retained even through a power failure.	While increasing or decreasing oven temperature, this does not affect self-cleaning temperature.
H2.5 Controlled	Temperature display	Press and hold Upper Cancel and Upper Bake pads for 3 seconds.	This mode enables the user to indicate °F or °C on the display.
H2.5 Controlled	Clock Display	Press and hold Upper Cancel and Clock pads for 3 seconds.	Allows clock to be toggled On or OFF.
H2.5 Controlled	24 Hour Clock	Press and hold Upper Cancel and Favorite pads for 3 seconds.	Allows the time on the clock to be toggled from 12 hour or 24 hour display.
H2.5 Controlled	Factory Default	Press and hold Upper Cancel and Upper Keep Warm pads for 3 seconds.	Allows the clock to be reset to factory settings.
H2.5 Controlled	Twelve hour off	Control automatically cancels/removes any cooking operations/relay drives 12 hours after the last pad touch.	See Sabbath mode to disable.
H2.5 Controlled	Sabbath Mode	Hold Clock pad for 3 to 5 seconds to activate Sabbath mode. Hold Clock pad for 3 to 5 seconds to disable Sabbath mode.	“SAbbAth” will display for 5 seconds, then change to “SAb” (displayed in Temp area). All pad inputs are disabled except for CANCEL and CLOCK pads. This mode disables the normal 12 hour shutoff to allow operation of the bake mode for a maximum of 72 hours.
H2.5 Controlled	Beeper Volume	Hold Upper Cancel and Delay pads for 3 seconds to adjust beeper loudness level.	Volume settings are Low, Medium and High.
H2.5 Controlled	Child lock out	Press and hold Upper Cancel and Cook & Hold pads for 3 seconds. “OFF” will display where the temperature normally appears. “LOCK” will display flashing while door is locking. To reactivate the control, press and hold Cancel and Cook & Hold pads for 3 seconds.	This is a safety feature that can be used to prevent children from accidentally programming the oven. It disables the electronic oven control. Child lockout features must be reset after a power failure.
H2.5 Controlled	Diagnostic Code Display	Press and hold Upper Cancel and Autoset pads for 3 seconds. See “Quick Test Mode.” Cycle through the codes using the number pads 1 through 5.	The last 5 diagnostic codes will be stored in the non-volatile memory. See “ Description of Error Codes ” for explanation.

Testing Procedures



WARNING

To avoid risk of electrical shock, personal injury or death; disconnect power and gas to oven before servicing, unless testing requires power and/or gas.

“Quick Test” Mode for Electronic Range Control

Follow the procedure below to perform the Electronic Range Control (ERC) quick test. Instructions must be entered within 32 seconds of each other (via the touch pad) or the ERC will exit the quick test.

1. **Press and hold** the *UPPER CANCEL* and *BROIL* pads for 3 seconds.
2. Once the control has entered the “Quick Test” mode, release both pads.
3. Press each of the following pads indicated in the table below.

NOTE: Press the applicable pad once to activate the associated response.
Press the applicable pad a second time to deactivate the associated response.

Display indicates the following:

Pad	Response
BAKE	Bake DLB and Bake relay activated
BROIL.....	Broil DLB and Broil relay activated
KEEP WARM	Bake DLB and Broil DLB activated
CONVECT BAKE	Convection Fan on low speed
CONVECT ROAST	Convection Fan on high speed
CLEAN.....	MDL relay activated
COOK & HOLD	Displays last diagnostic code
FAVORITE	Displays EEPROM version number
TIMER	Displays main code version number
CLOCK.....	All display segments illuminated
OVEN LIGHT.....	Oven light activated
CANCEL.....	Exit Quick Test mode
1.....	Even segments on
2.....	Odd segments on
3.....	Convection Ring activated; Convection Ring DLB activated
4.....	N/A
5.....	N/A
6.....	N/A
7.....	N/A
8.....	N/A
9.....	N/A
AUTOSET	Steps through last 5 diagnostic codes

Setup Options (0) pad is pressed “Press Desired Pad for Selection” will scroll in the display. When a feature is displayed the **AUTO SET** pad is used to toggle the options. Use the chart below to identify the available options.

Control Function	Pad Selection	Default Option	Additional Options
12 hour shut-off	1	12 HR Energy Saver ON	12 HR Energy Saver OFF
Timer beeps	2	Timer Reminder Beeps for 5 Min.	Timer Reminder Beeps for 30 Min. No Timer Reminder Beeps
Cook time beeps	3	Cook Time Reminder Beeps for 30 Min.	Cook Time Reminder Beeps for 5 Min. No Cook Time Reminder Beeps
Control lock	4	Control Unlocked	Control Locked
Scroll speed	5	Medium Speed	Fast Speed Slow Speed
Volume level	6	6 bars	1 to 8 bars
Temp C/F	7	Degrees F	Degrees C
Language	8	English	French, Spanish
Default	9	Press AUTO SET for Factory Settings	N/A
Display On/Off	Clock	Clock Display is ON	Clock Display is OFF

Testing Procedures



WARNING

To avoid risk of electrical shock, personal injury or death; disconnect power and gas to oven before servicing, unless testing requires power and/or gas.

Component	Test Procedure	Results
Electronic range control	<p>F1-1 –Upper Oven >650°F with door unlocked.....</p> <p>F1-2 –Lower Oven >650°F with door unlocked.....</p> <p>F1-3 –Upper Oven >950°F with door locked.....</p> <p>F1-4 –Lower Oven >950°F with door locked.....</p> <p>F1-7 –Membrane switch is not responding.....</p> <p>F3-1 –Upper sensor is shorted at (< 100 Ω) or open at (>5 K Ω).....</p> <p>F3-2 –Lower sensor is shorted at (< 100 Ω) or open at (>5 K Ω).....</p>	<p>Check actual upper oven temperature, if > 650°F check sensor.</p> <p>Check actual lower oven temperature, if > 650°F check sensor.</p> <p>Check actual upper oven temperature, if > 950°F check sensor.</p> <p>Check actual lower oven temperature, if > 950°F check sensor.</p> <p>Check membrane switch for connection or damage.</p> <p>Check upper sensor, harness, and connections</p> <p>Check upper sensor, harness, and connections</p>
Engineering Test Mode	<p>Press BAKE pad.</p> <p>Enter 100°F using the number pads.</p> <p>Immediately push and hold BAKE pad for appropriate oven approximately 3 seconds.</p> <p>This mode can also be entered by pressing the hidden pad for 3 second located to the left of the lower oven light pad.</p>	<p>Used to view the actual oven temperature for both ovens at all times, even when an oven function is active.</p> <p>This mode will also display the current fault code for 5 seconds in the time digits.</p>
Fault codes accessed through Engineering Test Mode	<p>F0-0 –No fault.....</p> <p>F1-5 –Upper hardware failure within control.....</p> <p>F1-6 –Lower hardware failure within control.....</p> <p>F1-8 –Shorted key in membrane switch.....</p> <p>F1-9 –Internal communication errors within control.....</p> <p>F1-A –Upper latch switches.....</p> <p>F1-B –Lower latch switches.....</p> <p>F1-C –Upper door switch.....</p> <p>F1-D –Lower door switch.....</p> <p>F1-E –Sensor input not calibrated.....</p> <p>F1-H –EEPROM error.....</p> <p>F1-L –Temp in ovens are the same for long period.....</p> <p>F1-N –Internal voltage on control not working.....</p> <p>F9-1 –Upper lock switch is not correct.....</p> <p>F9-2 –Upper unlock switch is not correct.....</p> <p>F9-3 –Control does not see upper door lock.....</p> <p>F9-4 –Lower lock switch is not correct.....</p> <p>F9-5 –Lower unlock switch is not correct.....</p> <p>F9-6 –Control does not see lower door lock.....</p> <p>EE –Control cannot read E-PROM. Unit will shut down.</p>	<p>Default from factory</p> <p>Replace control</p> <p>Replace control</p> <p>Check membrane connection</p> <p>Replace control</p> <p>Check latch wire harness</p> <p>Check latch wire harness</p> <p>Check lock wire harness</p> <p>Check lock wire harness</p> <p>Verify sensor is operating properly</p> <p>Replace control</p> <p>Verify sensor is operating properly</p> <p>Replace control</p> <p>Check lock wire harness, and lock switch</p> <p>Check lock wire harness, and lock switch</p> <p>Check lock wire harness, and lock switch</p> <p>Check lock wire harness, and lock switch</p> <p>Check lock wire harness, and lock switch</p> <p>Check lock wire harness, and lock switch</p> <p>Disconnect power for 60 seconds. If EE reappears, replace ERC</p>
Test Mode	<p>This mode must be activated within the first 5 minutes of power up.</p> <p>Press BROIL and CANCEL pad for approximately 3 seconds.</p> <p>If oven temperature is greater than 400°F, the Test Mode cannot be activated or will abort if active.</p> <p>Press and hold individual pads for 4 seconds to activate.</p> <p>Display will have dashes in all segments to indicate the mode is active.</p>	<p>Upper Bake: Energizes upper bake element</p> <p>Lower Bake: Energizes lower bake element</p> <p>Upper Broil: Energizes upper broil element</p> <p>Convection Bake: Energizes convection fan</p> <p>Upper Oven Light: Energizes upper oven light</p> <p>Lower Oven Light: Energizes lower oven light</p> <p>Upper Clean: Energizes upper motorized door lock</p> <p>Lower Clean: Energizes lower motorized door lock</p> <p>Stop Time: Energizes Beeper</p> <p>Cook Time: Displays error codes</p> <p>Timer 1: Energizes ROM version</p> <p>Timer 2: Energizes EEPROM version</p> <p>Keep Warm: Cooling Fan</p> <p>Clock: All display segments light</p> <p>If functions do not perform as specified, replace ERC</p>
Oven temperature adjustment	<p>Push BAKE pad.</p> <p>Enter 550°F using the number pads.</p> <p>Immediately push and hold BAKE pad for appropriate oven approximately 3 seconds.</p> <p>To decrease or increase oven temperature. Push AUTO SET pad until negative or positive numbers appear. Oven can be adjusted from -35° to +35° (-37.2° to + 1.6° C) in 5° F (2.7° C). To avoid over adjusting oven move temperature -5° each time. Push OVEN CANCEL button.</p>	<p>While increasing or decreasing oven temperature, this does not affect self-cleaning temperature.</p> <p>Holds offset through power outage.</p>

Disassembly Procedures



WARNING

To avoid risk of electrical shock, personal injury, or death: disconnect electrical and gas supply before servicing.

Moving and/or Replacing Range

1. Turn off electrical power and gas supply to the range.
2. Slide range forward from installation position.
3. Unplug power cord and disconnect gas line from unit.
4. Replace range using Installation Instructions.

NOTE: When placing range into installation position verify anti-tip bracket(s) are engaged.

Leveling Legs

- Some floors are not level.
- For proper baking, your range must be level.
 - Leveling legs are located on each corner of the base of the range.
 - Place a level horizontally on an oven rack and check front-to-back and side-to-side. Level by turning the legs.

Anti-Tip Bracket

When ever range is moved or replaced for safety reasons this bracket must be engaged.

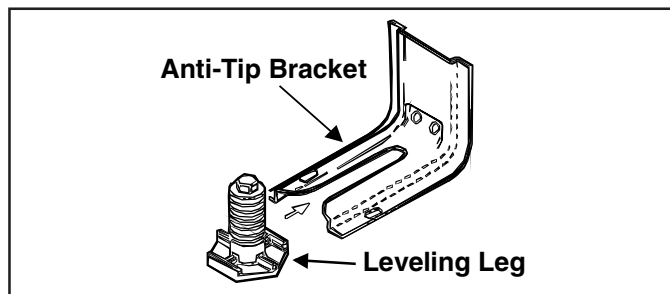

Top Burner

1. Disconnect power before servicing.
2. Remove screws securing burner to burner lower assembly.
3. Reverse procedures to reassemble.

Side Panel

NOTE: Removal of range from installation position is required.

1. Disconnect power before servicing.
2. Remove range from installation position, see "Move and/or Replacing Range" procedure.
3. Remove maintop, see "Maintop Removal" procedure. (Perform steps 1 – 6.)
4. Remove screws securing right side panel at the top and back of panel.
5. Pull side panel outward away from rear of range, then lift upward on the side panel to release from slotted clips located in front and set aside.
6. Reverse procedures to reassemble.

Maintop Removal

1. Disconnect power before servicing.
2. Remove surface burner control knobs by grasping knob and raising knob straight upward.
3. Remove screws securing infinite switch bracket to maintop.
4. Remove screws securing burner assemblies to maintop.
5. Remove screws securing maintop to chassis. Screws are located in the front left and right corners with the upper oven door open.
6. Remove screws securing ground strap to chassis.
7. Raise and remove maintop from unit.
8. Reverse procedures to reassemble.

Top Surface Valve and Spark Switch

1. Remove maintop, see "Maintop Removal" procedure. (Perform steps 1 – 6.)
2. Remove spark switch(es) by pulling upward off valve.
3. Remove wires from spark switch by depressing release arm.
4. Remove bolt(s) securing surface valve(s) to manifold. Located on the bottom of manifold.
5. Reverse procedures to reassemble.

NOTE: Perform gas leak test.

Top Burner Lower Assembly

1. Remove maintop, see "Maintop Removal" procedure. (Perform steps 1 – 6.)
2. Disconnect tubing from lower assembly.
3. Reverse procedures to reassemble.

NOTE: Perform gas leak test.

Manifold and Top Burner

1. Remove maintop, see "Maintop Removal" procedure. (Perform steps 1 – 6.)

NOTE: If replacing manifold only, skip step 2.

2. Loosen and disconnect fittings securing surface burner tubing to burner assembly and manifold.
3. Remove bolt(s) securing surface valve(s) to manifold.
4. Remove bolt securing shut-off valve from manifold.
5. Disconnect tubing from manifold to the regulator.
6. Reverse procedures to reassemble.

NOTE: Perform gas leak test.

Disassembly Procedures



WARNING

To avoid risk of electrical shock, personal injury, or death: disconnect electrical and gas supply before servicing.

Bake Element

1. Disconnect power before servicing.
2. Remove oven door for easier accessibility, see "Oven Door(s)-Door Removal" procedure.
3. Remove screws securing bake element to back of oven cavity.
4. Gently pull element through cavity wall until terminals can be accessed.
5. Label and disconnect wiring and remove element.
6. Reverse procedures to reassemble.

Broil Element

1. Disconnect power before servicing.
2. Remove oven door for easier accessibility, see "Oven Door(s)-Door Removal" procedure.
3. Remove broil element support brackets.
4. Remove screws securing broil element to back of oven cavity.
5. Gently pull element through cavity wall until terminals can be accessed.
6. Label and disconnect wiring and remove element.
7. Reverse procedures to reassemble.

Oven Sensor

The oven sensor is located inside oven cavity, attached to the upper left rear wall of the cavity.

1. Disconnect power before servicing.
2. Open oven door and remove screws securing sensor to oven cavity.

NOTE: Gently pull wiring through cavity wall.

3. Disconnect sensor at connector block and remove.
4. Reverse procedures to reassemble.

NOTE: Verify connect is pushed through the insulation.

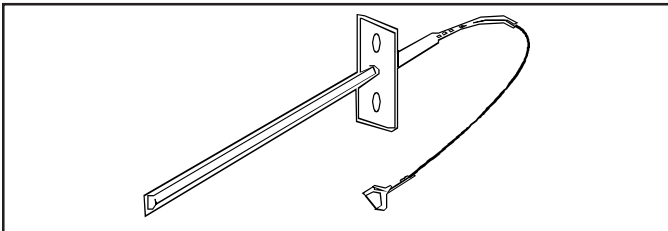

Electronic Clock

1. Disconnect power before servicing.
2. Remove vent deflector by removing screws located on the underside of the control panel.
3. Remove screws securing backguard panel to backguard housing. (Screws are located on the bottom and back side of control panel.)
4. Lift control panel up, tilt forward, and lay panel on a protected surface of the maintop for servicing.
5. Remove screw securing mounting plate to backguard.
6. Disconnect wiring and remove control.
7. Reverse procedures to reassemble.

Oven Light Replacement

The oven light used is a 120 volt, 20 watt Halogen bulb. The light automatically illuminates when the door is opened, or may be manually activated when the door is closed via the light pad. The light will not operate during a clean cycle. The oven light automatically illuminates one minute before the end of a clock-controlled cooking operation.

1. Disconnect power before servicing.
2. Open oven door and locate oven light.
3. Grasp lens cover and pull outward on one side to gain access to bulb.
4. Carefully remove old bulb, by lifting bulb straight out of ceramic base.

NOTE: To avoid damaging the new bulb and decreasing life of the bulb, do not touch new bulb with bare hands or fingers.

Hold with a cloth or paper towel.

5. Reverse procedures to reassemble.

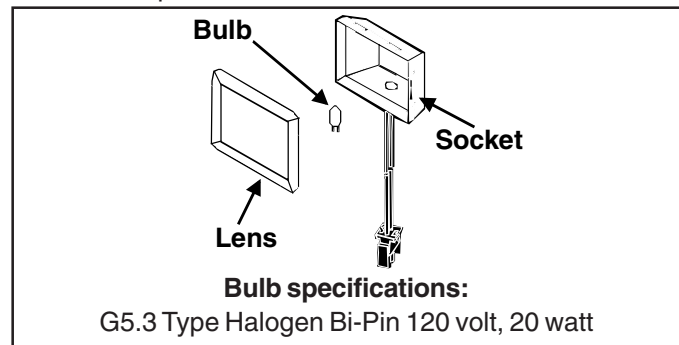

Oven Door(s)

Do not place excessive weight on an open oven door or stand on an opened door as, in some cases, it could cause the range to tip over, breakage of the door, or serious injury.

Both the upper and lower oven doors are removable.

NOTE: DO NOT LIFT OVEN DOOR USING HANDLE. Damage to the oven door and personal injury may occur.

Disassembly Procedures



WARNING

To avoid risk of electrical shock, personal injury, or death: disconnect electrical and gas supply before servicing.

Door Removal

- Open door to stop position (approximately 4"), then grasp both sides of the door and lift up off hinges.
- Lay door on a protected surface, liner side up.
- Close door hinges completely to avoid personal injury.

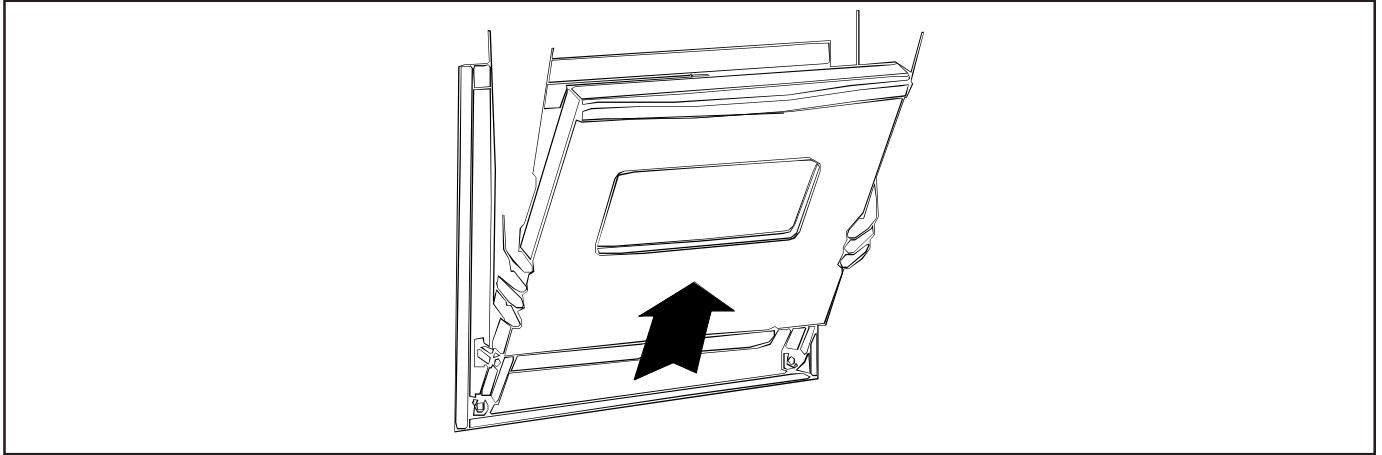

Door Replacement

1. Open door hinges to first stop position and align slots on the door with the hinge arms on the range.
2. Slide door downward onto hinge arms until the door is completely seated on the hinges. Push down on the top corners of the door to completely seat door on hinges. Door should not appear crooked.

NOTE: The oven door on a new range may feel "spongy" when closed. This is normal and will decrease with use.

Gasket and Door Disassembly

NOTE: Door gasket can be replaced by removing door insert clips and sliding gasket out of bottom door insert.

1. Remove oven door, see "Oven Door(s)-Door Removal" procedure.
2. Remove screws securing doorframe to liner located at the bottom.
3. Remove side screws securing doorframe to door liner.
4. Remove screws securing door trim at the top.
5. Slide doorframe and glass off liner from the bottom.
6. Remove screws securing door handle to door liner. (Two on the sides and two in front.)
7. Remove screws securing door baffle to liner.
8. Remove screws securing door baffle to window pack.
9. Remove door baffle and insulation wrap.
10. Remove screws securing window pack to liner. (Window pack comes out as an assembly.)

Disassembly Procedures



WARNING

To avoid risk of electrical shock, personal injury, or death: disconnect electrical and gas supply before servicing.

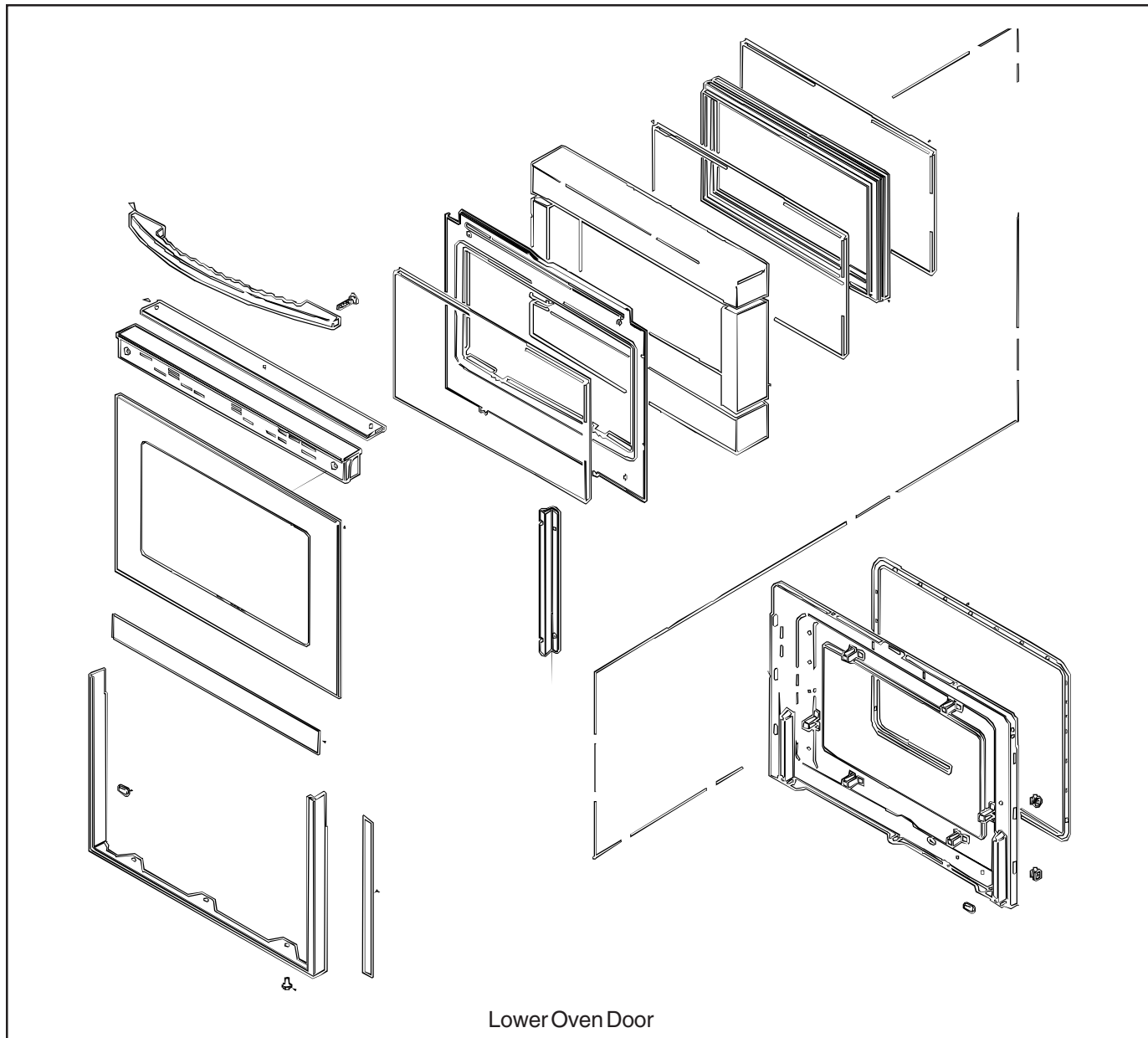

Lower Latch Assembly

NOTE: Removal of range from installation position is required.

1. Disconnect power before servicing.
2. Remove oven door, see "Oven Door(s)-Door Removal" procedure.
3. Remove range from installation position, see "Move and/or Replacing Range" procedure.
4. Remove maintop, see "Maintop Removal" procedure. (Perform steps 1 – 6.)
5. Remove left side panel, see "Side Panel" procedure.
6. Disconnect and label wiring from door lock switch and motor.
7. Remove screws securing latch assembly and slide assembly from range.
8. Reverse procedure to reassemble.

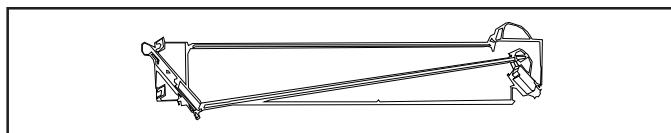

Disassembly Procedures



WARNING

To avoid risk of electrical shock, personal injury, or death: disconnect electrical and gas supply before servicing.

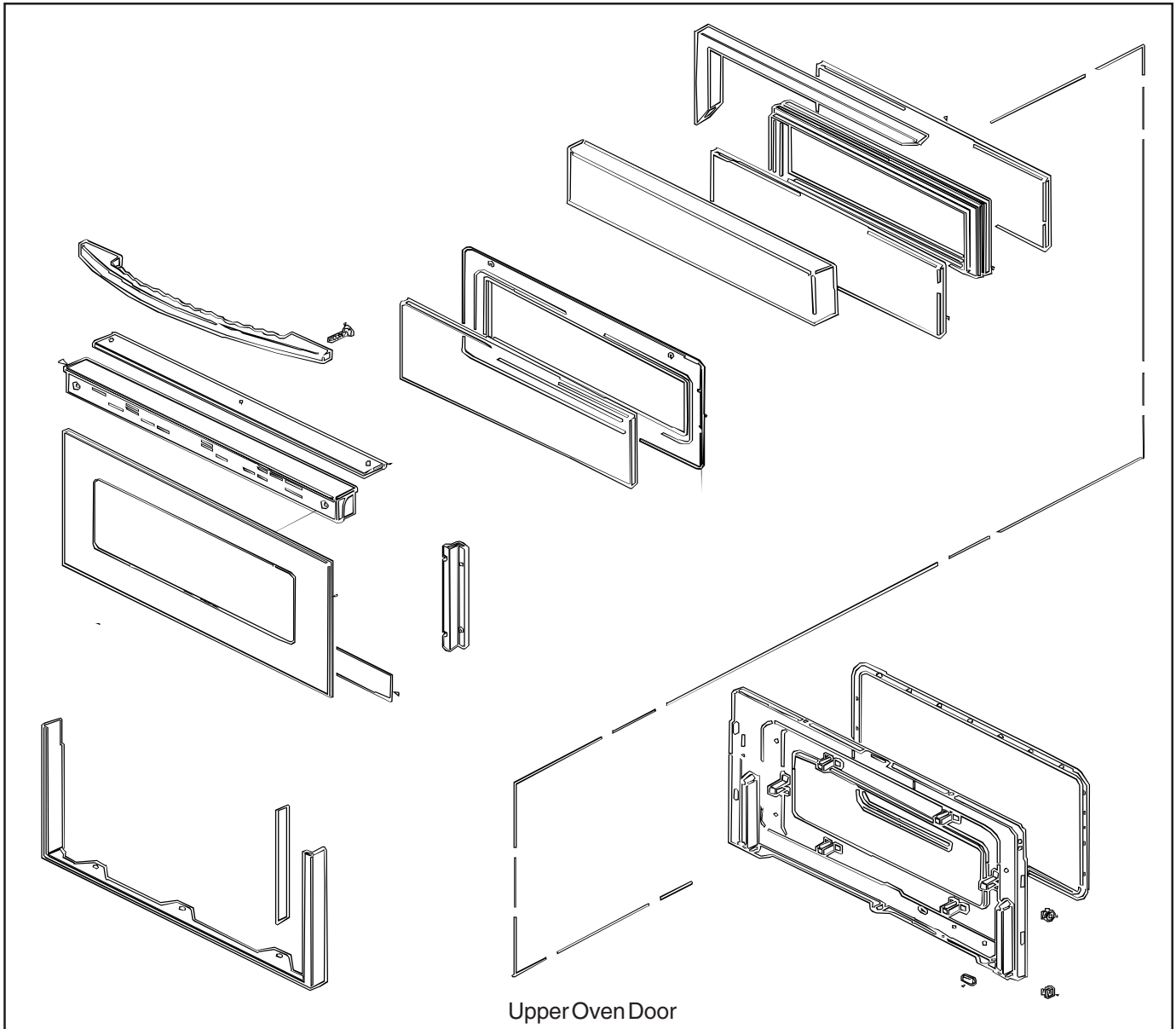

Upper Latch Assembly

1. Disconnect power before servicing.
2. Remove oven door, see "Oven Door(s)-Door Removal" procedure.
3. Remove maintop, see "Maintop Removal" procedure. (Perform steps 1 – 6.)
4. Disconnect and label wiring from door lock switch and motor.
5. Remove screws securing latch assembly and slide assembly from range.
6. Reverse procedure to reassemble.

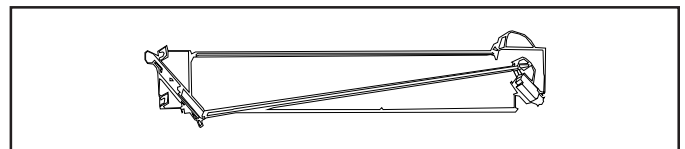

Disassembly Procedures



WARNING

To avoid risk of electrical shock, personal injury, or death: disconnect electrical and gas supply before servicing.

Oven Door Hinge

NOTE: Removal of range from installation position is required.

1. Disconnect power before servicing.
2. Remove oven door, see "Oven Door(s)-Door Removal" procedure.
3. Remove maintop, see "Maintop Removal" procedure. (Perform steps 1 – 6.)
4. Remove appropriate side panel (left or right), see "Side Panel" procedure.
5. Remove screws securing hinge to front frame flange.
6. Complete hinge assembly may be removed.
7. Reverse procedure to reassemble.

NOTE: The door hinges are colored coded for ease of installation. The upper spring hook is gold and the lower spring hook is white.



Regulator

NOTE: Removal of range from installation position is required.

1. Disconnect power before servicing.
2. Slide range forward out of installation position to gain access to components.
3. Disconnect tubing from regulator.
4. Remove screws securing bracket to back of unit.
5. Remove screws securing regulator to support bracket.
6. Reverse procedures to reassemble.

NOTE: When reconnecting supply line to regulator use pipe dope compound to seal the connection.

NOTE: Perform gas leak test.

Spark Module

NOTE: Removal of range from installation position is required.

1. Disconnect power before servicing.
2. Remove range from installation position, see "Move and/or Replacing Range" procedure.
3. Remove screws securing bottom rear access panel to chassis.

4. Remove screws securing top rear access panel to chassis.
5. Disconnect and label wire terminals from spark module.
6. Remove spark module from secured position.
7. Reverse procedures to reassemble. Gas Valve

NOTE: Removal of range from installation position is required.

1. Disconnect power before servicing.
2. Remove range from installation position, see "Move and/or Replacing Range" procedure.
3. Remove screws securing bottom rear access panel to chassis.
4. Remove screws securing top rear access panel to chassis.
5. Disconnect tubing from gas valve.
6. Disconnect and label wire terminals from gas valve.
7. Remove screws securing gas valve to chassis.
8. Reverse procedures to reassemble.

NOTE: Perform gas leak test.

Rocker Switch

1. Disconnect power before servicing.
2. Remove infinite switch control knobs located on the backguard.
3. Remove backguard, see "Oven Control/Electronic Clock" procedures. (Perform steps 1 – 4.)
4. Remove housing securing rocker switch to the backguard.
5. Label and disconnect wiring and remove switch.
6. Reverse procedures to reassemble.

Indicator Lamps

Indicator lamps include "Hot Surface" and "Element On."

1. Disconnect power before servicing.
2. Remove infinite switch control knobs located on the backguard.
3. Remove backguard, see "Oven Control/Electronic Clock" procedures. (Perform steps 1 – 4.)
4. Remove housing securing indicator lamps to the backguard.
5. Label and disconnect wiring and remove lamps.
6. Reverse procedures to reassemble.

Disassembly Procedures



WARNING

To avoid risk of electrical shock, personal injury, or death: disconnect electrical and gas supply before servicing.

Hi-Limit Thermostat

NOTE: Removal of range from installation position is required.

1. Disconnect power before servicing.
2. Remove range from installation position, see "Move and/or Replacing Range" procedure.
3. Remove screws securing main back shield and remove shield.
4. Remove screws securing thermostat to range main back.
5. Label and disconnect wiring and remove thermostat.
6. Reverse procedures to reassemble.

Door Plunger

NOTE: Removal of range from installation position is required.

1. Disconnect power before servicing.
2. Remove range from installation position, see "Move and/or Replacing Range" procedure.
3. Remove maintop, see "Maintop Removal" procedure. (Perform steps 1 – 6.)
4. Remove right side panel, see "Side Panel" procedure.
5. Disconnect and label wire terminals from door plunger switch.
6. Open oven door and remove screws securing door plunger to the front of the oven cavity.
7. Reverse procedures to reassemble.

Infinite Switch

The infinite switch is a rotary switch, which controls the power dissipated by a heating element. They are located on the control panel.

1. Disconnect power before servicing.
2. Remove infinite switch control knobs located on the backguard.
3. Remove backguard, see "Oven Control/Electronic Clock" procedures. (Perform steps 1 – 4.)
4. Remove screws securing infinite switch to backguard.
5. Label and disconnect wiring and remove infinite switch.

NOTE: When replacing an infinite switch, ensure the switch is matched to the element.

Convection Assembly

1. Disconnect power before servicing.
2. Remove oven door, see "Oven Door(s)-Door Removal" procedure.
3. Remove oven racks from oven cavity.
4. From inside the oven cavity (center-rear), remove screws securing assembly shroud or ring-cover.
5. Remove screws securing assembly to cavity.

6. Remove by gently rotating assembly until enough clearance is established between assembly, cavity wall and wire terminals/connectors.
7. Disconnect and label wire terminals from heat element and assembly (connector block).
8. Remove assembly from cavity.
9. Reverse procedures to reassemble.

Oven Racks

- All racks are designed with a lock-stop edge.

Upper Oven

- Equipped with one rack and rack position.
- When pulling the upper oven rack out to remove or check food, grasp the front edge of the rack.

Lower Oven

- Equipped with two RollerGlide™ racks.

To remove oven racks:

- Pull rack straight out until it stops at the lock-stop position; lift up on the front of the rack and pull out.
- For lower oven racks, pull both the rack glide and rack base out together.

To replace oven racks:

- Place rack on the rack support in the oven; tilt the front end up slightly; slide rack back until it clears the lock stop position; lower front and slide back into the oven.

Rack Positions

Rack 4: Use for some two-rack baking.

Rack 3: Use for most baked goods on a cookie sheet or jelly roll pan, layer cakes or frozen pies.

Rack 2: Use for roasting small cuts of meat, casseroles, baking loaves of bread, bundt cakes or custard pies and cakes and cookies.

Rack 1: Use for roasting large cuts of meat and poultry, dessert souffles or angel food cake, and two-rack baking of biscuits.

Multiple Rack Cooking:

Two Rack: Use rack position 1 and 4, 1 and 5 or 2 and 5.

Half Rack Accessory

A half rack, to increase oven capacity, is available as an accessory. It fits in the left, upper portion of the oven and provides space for a vegetable dish when a large roaster is on the lower rack.

Contact your Maytag dealer for the "HALFRACK" Accessory Kit or call 1-800-688-8408.

Disassembly Procedures



WARNING

To avoid risk of electrical shock, personal injury, or death: disconnect electrical and gas supply before servicing.

Oven Cavity Components (Electric)

Open or remove the oven door. The following components are accessible:

Upper Oven

- Racks
- Oven Sensor
- Broiler
- Bake Element

Lower Oven

- Racks
- Oven Sensor
- Bake Element
- Broiler
- Convect Element
- Convect Fan

Appendix A

Jenn-Air Double Oven Freestanding Range



Cuisinière autonome à deux fours Jenn-Air/
Estufa independiente con horno doble Jenn-Air

Installation Instructions/Instructions d'installation/Instrucciones de Instalación



MODEL SERIES: JDR8895
SÉRIE DE MODÈLE : JDR8895
SERIES DEL MODELO: JDR8895

INSTALLER: Leave these instructions with the appliance./INSTALLATEUR : Laissez ces instructions avec l'appareil./
INSTALADOR: Deje estas instrucciones con el electrodoméstico.

Installation Instructions



Double Oven Freestanding Range

INSTALLATION INSTRUCTIONS

PLEASE KEEP THIS MANUAL FOR FUTURE REFERENCE

This manual is intended to assist in the initial installation and adjustments of the range.

- Only qualified personnel should install or service this range.
- Read "Safety Instructions" in Use & Care book before using range.
- Improper installation, adjustment, alteration, service, maintenance or use of range can result in serious injury or property damage.

CAUTIONS

Do not lift or move range by grasping door handles, main top, or backguard.



This range has been designed in accordance with the requirements of various safety agencies and complies with the maximum allowable wood cabinet temperatures of 194°F. If this range is installed with cabinets that have a lower working temperature than 194°F, discoloration, delamination or melting may occur.

Place range in a well lit area. Do not set range over holes in the floor or other locations where it may be subject to strong drafts. Any opening in the wall behind the range and in the floor under the range should be sealed. Make sure the flow of cooling/ventilation air is not obstructed below the range. Note: A range should NOT be installed over kitchen carpeting.

High Altitude Notice: The specified gas burner ratings typically apply to elevations up to 2000 feet. For higher altitudes, the rates may need to be reduced to achieve satisfactory operation. A local certified gas servicer will be able to advise if a reduction is necessary.

CONNECTING THE RANGE

The range must be installed in accordance with Local and National Electric Code (NEC) ANSI/NFPA No. 70-latest edition, or Canadian Electric Code CSA STD.C22.1 latest edition. See rating plate for total connected KW rating.

Your local utility company will tell you whether the present electric service to your home is adequate. It may be necessary to increase the size of the wiring to the house and service switch to take care of the electrical load demanded by the range. The kilowatt rating for the range is specified on the rating plate located on flip-up plate at the rear center of backguard.

Most local Building Regulations and Codes require that all electrical wiring be done by licensed electricians. All wiring should conform to Local and National Electrical



WARNING

- All RANGES CAN TIP AND CAUSE INJURIES TO PERSONS.
- INSTALL ANTI-TIP DEVICES PACKED WITH RANGE.
- FOLLOW ALL INSTALLATION INSTRUCTIONS.

A risk of range tip-over exists if the appliance is not installed in accordance with the provided installation instructions. The proper use of the ANTI-TIP device minimizes the risk of TIP-OVER. In using this device the consumer must still observe the safety precautions as stated in the USE and CARE MANUAL and avoid using the oven doors as a step stool. Installation instructions are provided for wood and cement in either floor or wall. Any other type of construction may require special installation techniques as deemed necessary to provide adequate fastening of the ANTI-TIP bracket to the floor or wall. The bracket may be installed to engage the LEFT or RIGHT rear leveling foot. NOTE: The bracket provided is designed for use with flush mount and non-flush mount outlet receptacles. Install the bracket with the orientation hole in the longer leg against the wall or floor as shown in steps 14-19.

MOBILE HOMES

The installation of a range designed for mobile home installation must conform with the Manufactured Home Construction and Safety Standard, Title 24 CFR, Part 3280 (formerly the Federal Standard for Mobile Home Construction and Safety, Title 24 HUD, Part 280) or, when such standard is not applicable, the Standard for Manufactured Home Installations ANSI A225.1/NFPA 501A, or with local codes. In Canada the range must be installed in accordance with the current CSA Standard C22.1 - Canadian Electrical Code Part 1 and Section Z240.4.1 - Installation Requirements for Gas Burning Appliances in Mobil Homes (CSA Standard CAN/CSA - Z240MH).

RECREATIONAL PARK TRAILERS

The installation of a range designed for recreational park trailers must conform with state or other codes or, in the absence of such codes, with the Standard for Recreational Park Trailers, ANSI A119.5-latest edition. In Canada the range must be installed in accordance with CAN/CSA - Z240.6.2 - Electrical Requirements for R.V.'s (CSA Standard CAN/CSA - Z240 RV Series) and Section Z240.4.2 - Installation Requirements for Propane Appliances and Equipment in R.V.'s (CSA Standard CAN/CSA - Z240 RV Series).

Codes. This range requires a single phase three wire 120/240 or a 120/208 volt, 60 Hz, AC circuit. Wiring codes require a separate circuit be run from the main entrance panel to the range and that it be equipped with separate disconnect switch and fuses, either in the main entrance panel or in a separate switch and fuse box.

Some models are shipped direct from the factory with service cord attached. There are no range connections necessary on these models. Just plug into the wall outlet. On models not provided with a service cord, connection to the power supply is necessary in accordance with local codes. Provisions for using either conduit or a flexible power cord are provided. When using a power supply cord, use only a supply cord with closed loop terminals rated either 240 volts, 40 amps or 240 volts, 50 amps that is marked for use with nominal 1-3/8" (34.94 mm) diameter connection opening and marked for ranges. A 4-conductor cord is to be used on

Installation Instructions

CONNECTING THE RANGE (cont.)

new branch-circuit installations (1996 NEC), mobile homes, recreational vehicles and where local codes prohibit grounding through the neutral conductor. A 3-wire service may be used when permitted by local codes. When a power supply cord is used, a cord no longer than 4 feet should be used.

Canada

This model is shipped direct from the factory with the service cord attached. There are no range connections necessary.

GAS SUPPLY CONNECTION

Gas Supply

Installation of this range must conform with local codes or, in the absence of local codes, with the National Fuel Gas Code, ANSI Z223.1-latest edition. In Canada the range must be installed in accordance with the current CGA Standard CAN/CGA-B149 - Installation Codes for Gas Burning Appliances and Equipment and/or local codes.

A QUALIFIED SERVICEMAN OR GAS APPLIANCE INSTALLER MUST MAKE THE GAS SUPPLY CONNECTION. Leak testing of the appliance shall be conducted by the installer according to the instructions given in step 13.

Apply a non-corrosive leak detection fluid to all joints and fittings in the gas connection between the supply line shut-off valve and the range. Include gas fittings and joints in the range if connections were disturbed during installation. Check for leaks! Bubbles appearing around fittings and connections will indicate a leak. If a leak appears, turn off supply line gas shut-off valve, tighten connections, turn on the supply line gas shut off valve, and retest for leaks.

CAUTION: NEVER CHECK FOR LEAKS WITH A FLAME. WHEN LEAK CHECK IS COMPLETE, WIPE OFF ALL RESIDUE.

NATURAL GAS SUPPLY LINE MUST HAVE A NATURAL GAS SERVICE REGULATOR. INLET PRESSURE TO THIS APPLIANCE SHOULD BE REDUCED TO A MAXIMUM OF 14 INCHES WATER COLUMN (0.5 POUNDS PER SQUARE INCH (P.S.I.) LIQUEFIED PETROLEUM (L.P.)/PROPANE GAS SUPPLY LINE MUST HAVE A L.P. GAS PRESSURE REGULATOR. INLET PRESSURE TO THIS APPLIANCE SHOULD BE REDUCED TO A MAXIMUM OF 14 INCHES WATER COLUMN (0.5 P.S.I.). INLET PRESSURES IN EXCESS OF 0.5 P.S.I. CAN DAMAGE THE APPLIANCE PRESSURE REGULATOR AND OTHER GAS COMPONENTS IN THIS APPLIANCE AND CAN RESULT IN A GAS LEAK.

Gas supply pressure for testing regulator must be at least 1" water column pressure above manifold pressure shown on serial plate.

NOTE: It is recommended to use a CSA certified flexible connector no longer than 36" (91.4 cm) with a minimum BTU/HR rating of 88,200.

HOW TO REMOVE RANGE FOR SERVICING

Follow these procedures to remove appliance for servicing:

1. Slide range forward to disengage range from the anti-tip bracket.
2. Shut off gas supply to appliance.
3. Disconnect electrical supply to appliance, if equipped.
4. Disconnect gas supply tubing to appliance.
5. Reverse procedure to reinstall. If gas line has been disconnected, check for gas leaks after reconnection.
6. To prevent range from accidentally tipping, range must be secured to the floor by sliding rear leveling leg into the anti-tip bracket.

NOTE: A qualified servicer should disconnect and reconnect the gas supply. The servicer MUST follow installation instructions provided with the gas appliance connector and the warning label attached to the connector.

SERVICE-PARTS INFORMATION

When your range requires service or replacement parts, contact your dealer or authorized service agency. Please give the complete model and serial number of the range which is located on flip-up plate at the rear of upper left-hand corner or center of backguard.

Your range may not be equipped with some of the features referred to in this manual.

In The Commonwealth Of Massachusetts

This product must be installed by a licensed plumber or gas fitter when installed within the Commonwealth of Massachusetts. A "T" handle type manual gas valve must be installed in the gas supply line to this appliance. A flexible gas connector, when used, must not exceed a length of three (3) feet / 36 inches.

WARNING

Gas leaks may occur in your system and result in a dangerous situation. Gas leaks may not be detected by smell alone. Gas suppliers recommend you purchase and install an UL approved gas detector. Install and use in accordance with manufacturer's instructions.

Check Pressure of House Piping System

1. The appliance and its individual shutoff valve must be disconnected from the gas supply piping system during any pressure testing of that system at test pressures in excess of 1/2 lbs./sq. in. (3.5 kPa) (13.8 in. water column).
2. The appliance must be isolated from the gas supply piping system by closing its individual manual shutoff valve during any pressure testing of the gas supply piping system at test pressures equal to or less than 1/2 lbs./sq. in. (3.5 kPa) (13.8 in. water column).

A GAS SHUT-OFF VALVE SHOULD BE PUT IN AN ACCESSIBLE LOCATION IN THE SUPPLY LINE AHEAD OF THE RANGE, FOR TURNING ON AND TURNING OFF GAS SUPPLY. Range is to be connected to house piping with flexible metal connectors for gas appliances. CONNECTOR NUTS MUST NOT BE CONNECTED DIRECTLY TO PIPE THREADS. THE CONNECTORS MUST BE INSTALLED WITH ADAPTORS PROVIDED WITH THE CONNECTOR.

The house piping and/or range connector used to connect the range to the main gas supply must be clean, free of metal shavings, rust, dirt and liquids (oil or water). Dirt, etc. in the supply lines can work its way into the range manifold and in turn cause failure of the gas valves or controls and clog burners and/or pilot orifices.

Always use a new flexible connector. Do not use existing flexible connector.

WARNING

DISCONNECT ELECTRICAL SUPPLY BEFORE SERVICING THE APPLIANCE.

Installation Instructions

Dimensions/Dimensions/Dimensiones

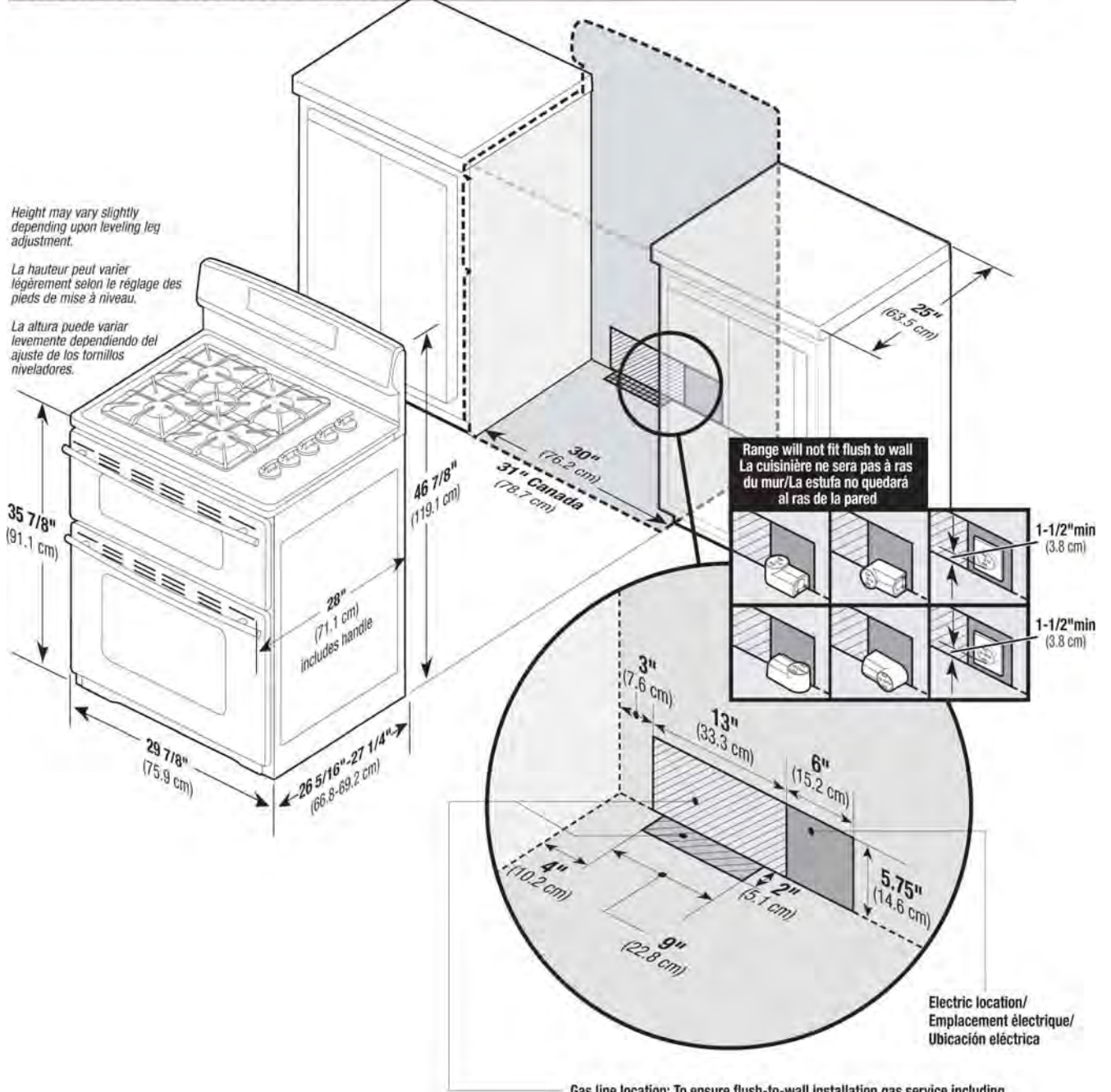

Gas line location: To ensure flush-to-wall installation gas service including shut-off valve should not protrude more than 2" (5.1 cm) from rear wall nor extend beyond the shaded areas./

Emplacement de la conduite de gaz : Pour obtenir une installation à ras du mur, le service du gaz incluant le robinet d'arrêt ne peut dépasser du mur arrière de plus de 5,1 cm (2 po) ou au-delà des zones ombrées. /

Ubicación de la tubería de gas: Para asegurar una instalación al ras de la pared, el suministro de gas, incluyendo la válvula de cierre, no se debe extender a más de 2" (5,1 cm) de la pared trasera o quedar por fuera de las áreas sombreadas.

Important: Because of continuing product improvements, Maytag reserves the right to change specifications without notice. Dimensional specifications are provided for planning purposes only. For complete details see installation instructions that accompany each product before selecting cabinetry, making cutouts or beginning installation.

Important : En raison de l'amélioration continue de ses produits, Maytag se réserve le droit de changer les spécifications sans préavis. Les spécifications dimensionnelles sont fournies à des fins de planification seulement. Pour obtenir des détails complets, consultez les instructions d'installation qui accompagnent chaque produit avant de choisir les armoires, de faire des découpes ou de commencer l'installation.

Importante: Debido a las mejoras continuas del producto, Maytag se reserva el derecho de cambiar las especificaciones sin aviso previo. Las especificaciones dimensionales se proporcionan para propósitos de planificación únicamente. Para obtener los detalles completos, vea las instrucciones de instalación que acompañan a cada producto antes de seleccionar los armarios, hacer los cortes o comenzar la instalación.

Installation Instructions

Conduit Option/Option pour conduit/Opción del conducto

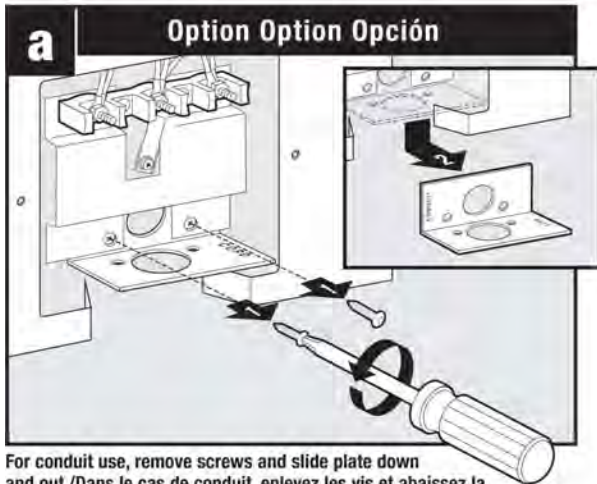

For conduit use, remove screws and slide plate down and out./Dans le cas de conduit, enlevez les vis et abaissez la plaque pour la sortir./Para usar el conducto, retire los tornillos y deslice la placa hacia abajo y hacia afuera.

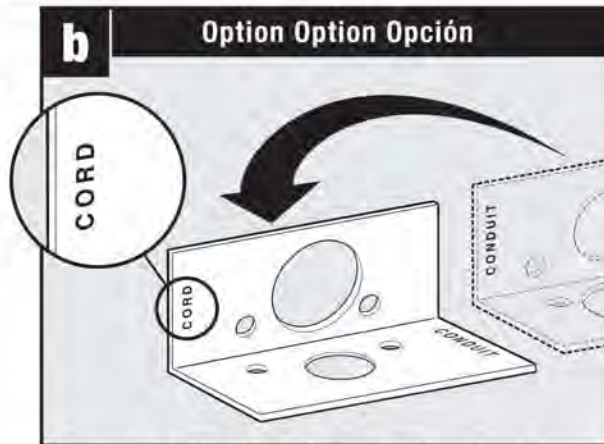

Position conduit plate as shown./Positionnez la plaque à conduit comme il est illustré./Coloque la placa del conducto como se muestra.

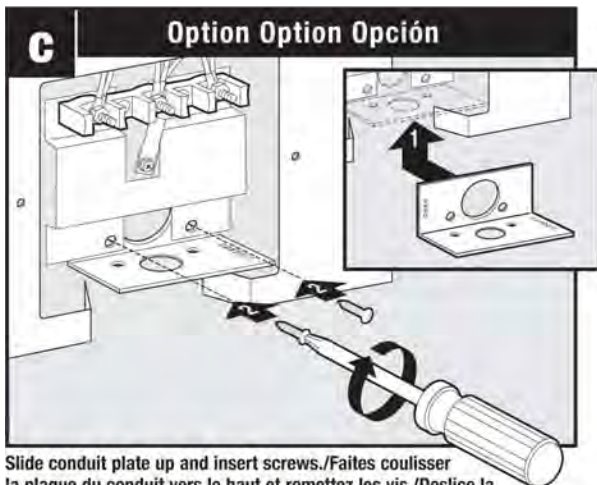

Slide conduit plate up and insert screws./Faites coulisser la plaque du conduit vers le haut et remettez les vis./Deslice la placa del conducto hacia arriba y coloque los tornillos.

Installation Instructions

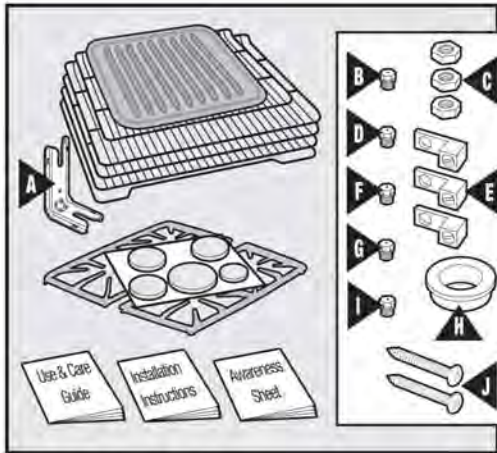

Included./Compris./Se incluye.

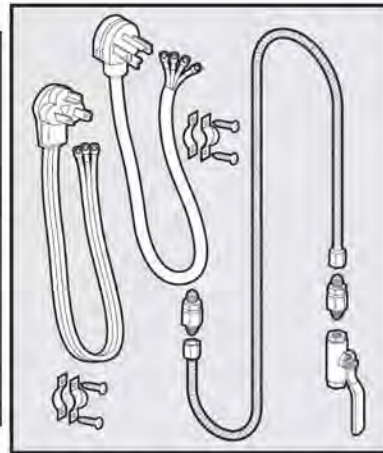

Not Included./Non inclus./No se incluye.

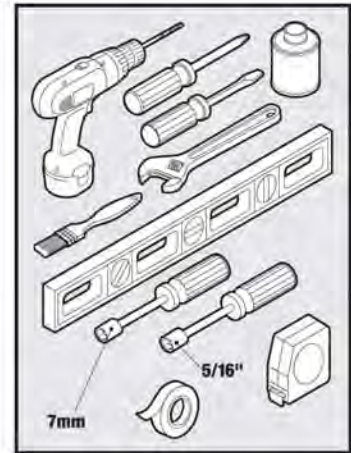

Tools Needed./Outils nécessaires./Herramientas Necesarias.

Identify Electrical Connection/Identifiez le raccordement électrique/Identifique la conexión eléctrica

Note: Some models are shipped directly from the factory with a service cord connected. No additional connections are needed./Remarque : Certains modèles sont livrés directement de l'usine avec un cordon d'alimentation. Aucun raccordement supplémentaire n'est nécessaire./Nota: Algunos modelos vienen equipados de la fábrica con un cordón eléctrico de servicio instalado. No es necesario realizar conexiones adicionales.

A Existing Outlet/
Prise existante/
Tomacorriente existente

Plug Needed
Fiche nécessaire/
Se necesita enchufe

240v 3-Wire/240 V, 3 fils/
Cable Trifilar para 240 V

B Existing Outlet/
Prise existante/
Tomacorriente existente

Plug Needed
Fiche nécessaire/
Se necesita enchufe

240v 4-Wire/240 V, 4 fils/
Cable Tetrafililar para 240 V

C Existing Connection/
Raccordement existant/
Conexión existente

240v 3-Wire/240 V, 4 fils/
Cable Tetrafililar para 240 V

D Existing Connection/
Raccordement existant/
Conexión existente

240v 4-Wire/240 V, 4 fils/
Cable Tetrafililar para 240 V

Before Installation/Avant l'installation/Antes de la instalación

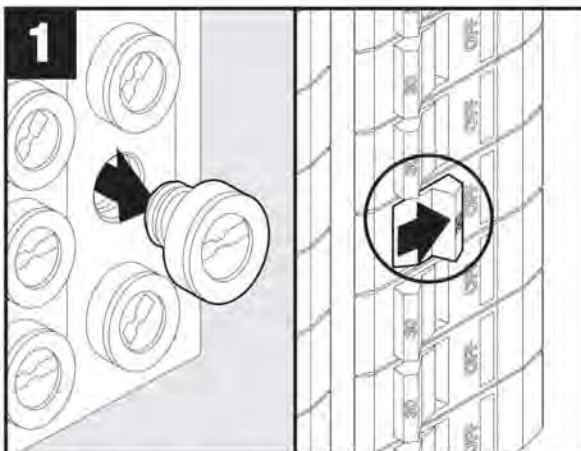

1 Turn off power source./Coupez l'alimentation./Apague el suministro eléctrico.

If you have LP (propane) find instructions and parts in kit on rear of range below regulator./

Dans le cas de GPL (propane), les instructions et les pièces se trouvent dans un nécessaire à l'arrière de la cuisinière sous le détendeur./

Si cuenta con un suministro de gas LP (propano), puede encontrar instrucciones y un kit de piezas en la parte trasera de la estufa debajo del regulador.

Installation Instructions

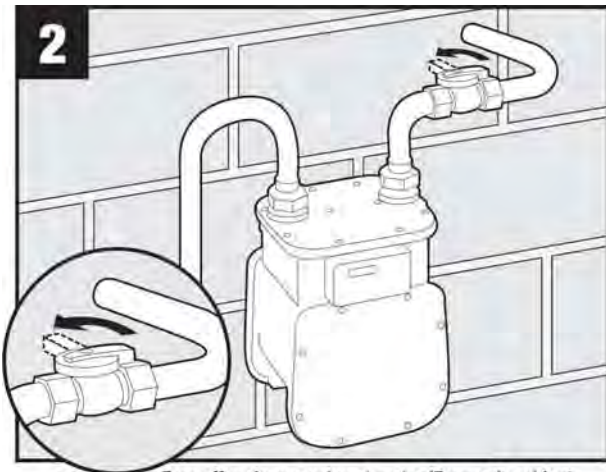

2 Turn off main gas valve at meter./Fermez le robinet principal au niveau du compteur./Cierre la válvula de gas en el medidor.

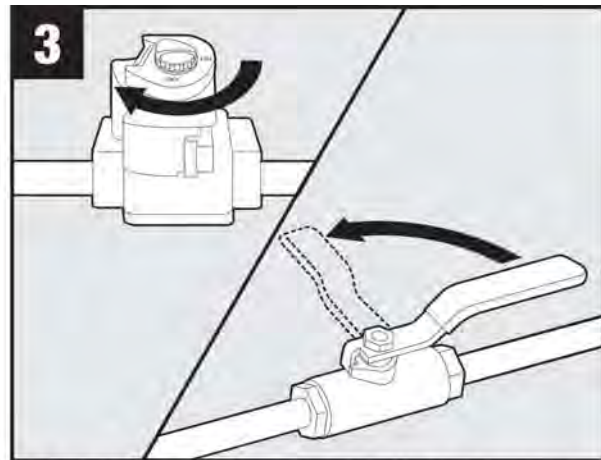

3 Turn off gas supply shut-off valve./Fermez le robinet de l'alimentation en gaz./Cierre la válvula de cierre del gas.

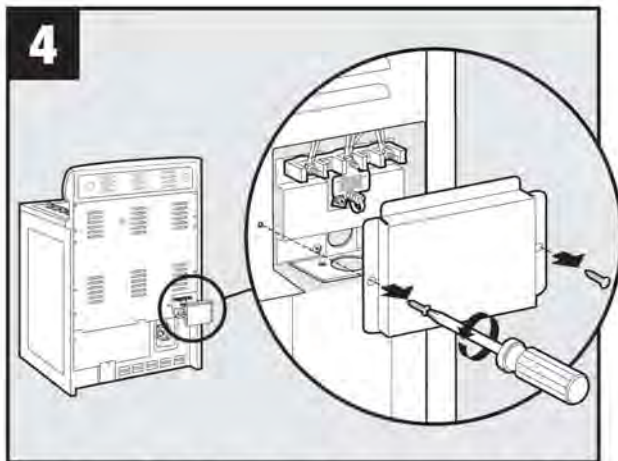

4 Remove terminal block access cover./Enlevez le couvercle d'accès de la plaque à bornes./Retire la tapa de acceso del tablero de terminales.

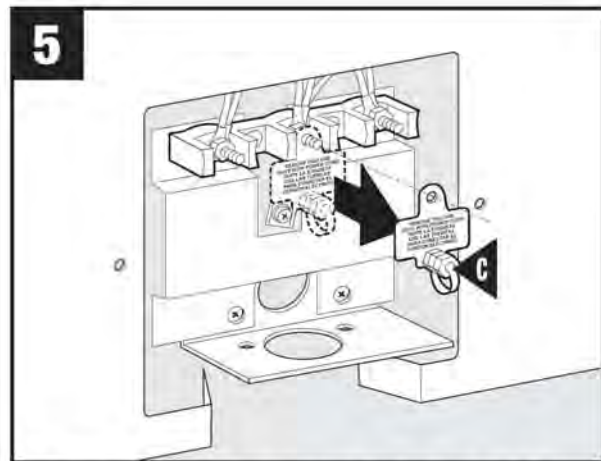

5 Remove hex nut holder./Enlevez la retenue de l'écrou hex./Retire el soporte de la tuerca hexagonal.

If you have electrical connection:
Si vous avez un raccordement électrique :
Si ya tiene una conexión eléctrica:

- | | | |
|----------|---------------------------|-----------|
| A | Go to / Passez à / Vaya a | A1 |
| B | Go to / Passez à / Vaya a | B1 |
| C | Go to / Passez à / Vaya a | C1 |
| D | Go to / Passez à / Vaya a | D1 |

Note: Conduit users should refer to special option steps on the last page./
Remarque : Les utilisateurs de conduits devraient se reporter aux étapes pour les options spéciales de la dernière page./
Nota: Si va a utilizar un conducto, consulte los pasos opcionales especiales en la última página.

Installation Instructions

3-Wire Connection/Raccordement - 3 fils/Conexión trifilar

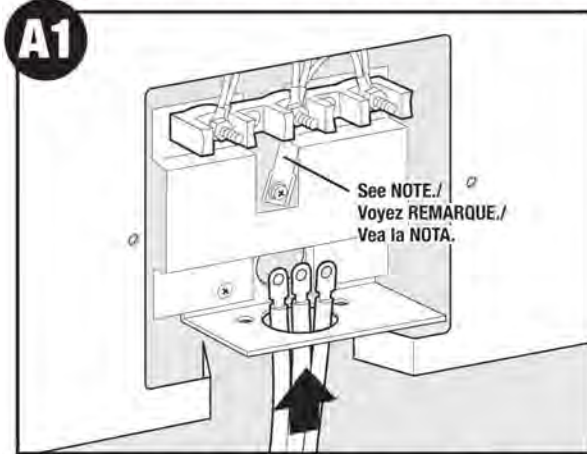

Pull service cord through./Passez le cordon électrique ici./Tire del cordón eléctrico.

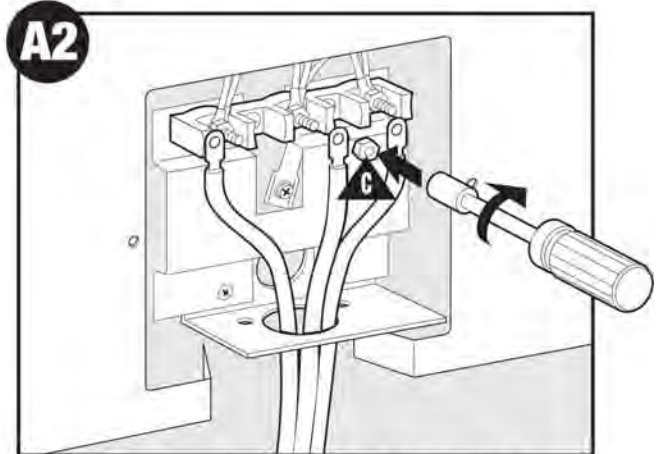

Middle wire **MUST** connect to middle post./Le fil du milieu **DOIT** être raccordé à la borne centrale./El alambre central **DEBE** conectarse al conector central.

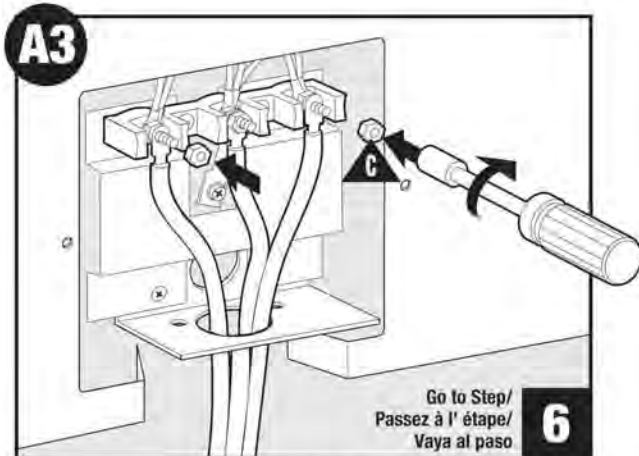

Connect remaining wires./Raccordez les autres fils./Conecte los alambres restantes.

NOTE: The copper ground strap **MUST** stay connected between middle post and range./
REMARQUE : La bande en cuivre de mise à la terre **DOIT** rester branchée entre la borne centrale et la cuisinière./
NOTA: La cinta de cobre de puesta a tierra **DEBE** permanecer conectada entre el conector central y la estufa.

4-Wire Connection/Raccordement - 4 fils/Conexión tetrafilar

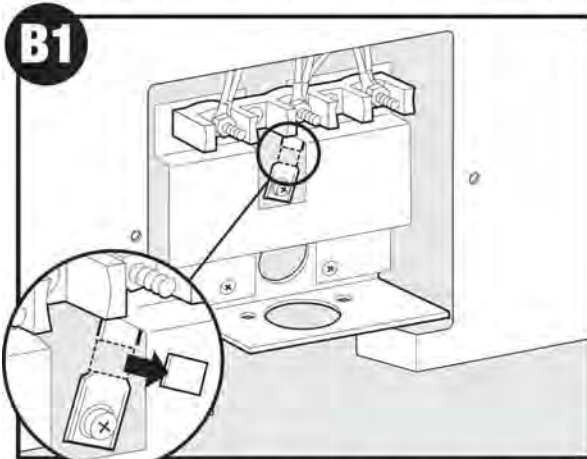

Part of copper ground strap **MUST** be cut out and removed./Une section de la bande en cuivre de mise à la terre **DOIT** être coupée et enlevée./Una parte o la totalidad de la cinta de conexión a tierra **DEBE** ser cortada y descartada.

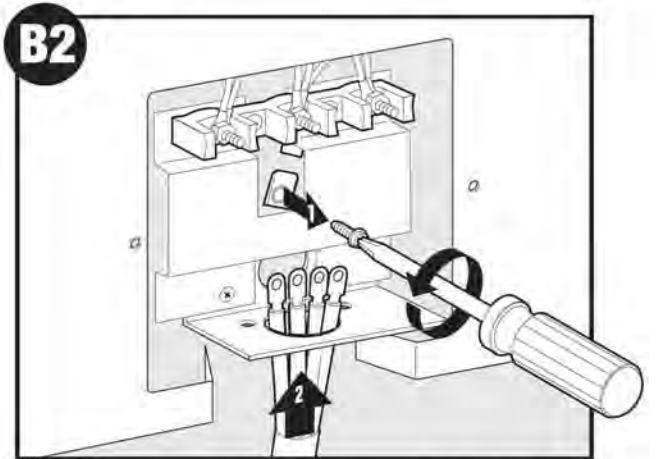

Remove grounding screw, pull service cord through./Retirez la vis de mise à la terre, et passez le cordon d'alimentation./Retire el tornillo de puesta a tierra y tire del cordón eléctrico de servicio a través del agujero.

Installation Instructions

4-Wire Connection (cont)/Raccordement - 4 fils (suite)/Conexión tetrafilar (cont.)

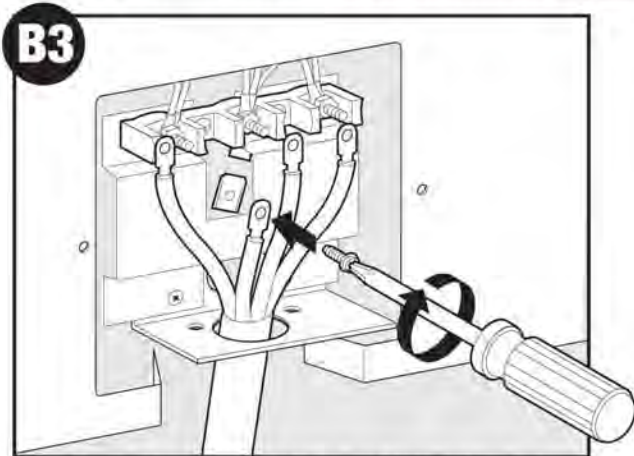

Connect ground wire./Raccordez le fil de mise à terre./Conecte el alambre de tierra.

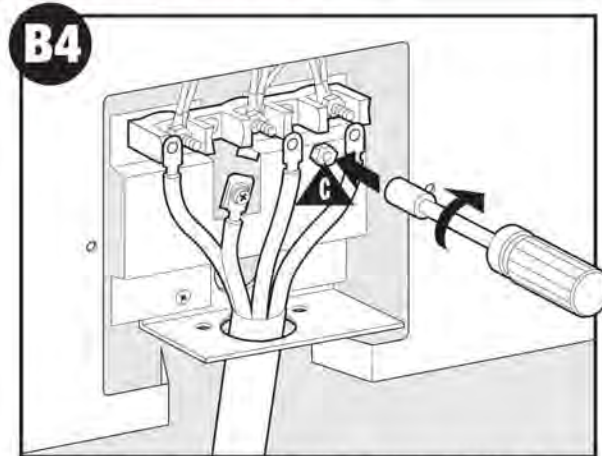

Connect white neutral wire to middle post./Raccordez le fil blanc du neutre à la borne centrale./Conecte el alambre blanco del neutro al conector central.

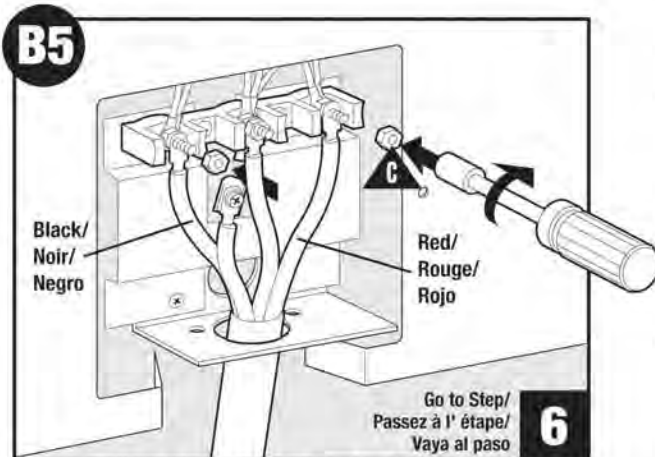

Connect remaining wires./Raccordez les autres fils./Conecte los alambres restantes.

NOTE: cord replacement - Only a power cord rated at 240 volts minimum, 40 amperes or 50 amperes power supply cord that is marked for use with nominal 1 2/8" (34.93mm) diameter connection opening, with closed loop terminals and marked for use with ranges shall be used.

REMARQUE : Remplacement du cordon - N'utilisez qu'un cordon d'alimentation pour 240 volts minimum, 40 ou 50 ampères, prévu pour être utilisé avec des cosses fermées - ouverture de 34,93 mm (1-3/8 po) de diamètre et pouvant être utilisé avec des cuisinières.

NOTA: reemplazo del cordón - Use sólo un cordón eléctrico clasificado para por lo menos 240 voltios. Sólo utilice cordones eléctricos de 40 o 50 amperios marcados para su uso en estufas con una abertura de conexión nominal de 1-3/8" (34,93 mm) de diámetro y para terminales de bucle cerrados.

Bare 3-Wire Connection/Raccordement - 3 fils dénudés/Conexión trifilar descubierta

Note: Conduit users should refer to special option steps on the last page./**Remarque :** Les utilisateurs de conduits devraient se reporter aux étapes pour les options spéciales de la dernière page./**Nota:** Si va a utilizar un conducto, consulte los pasos opcionales especiales en la última página.

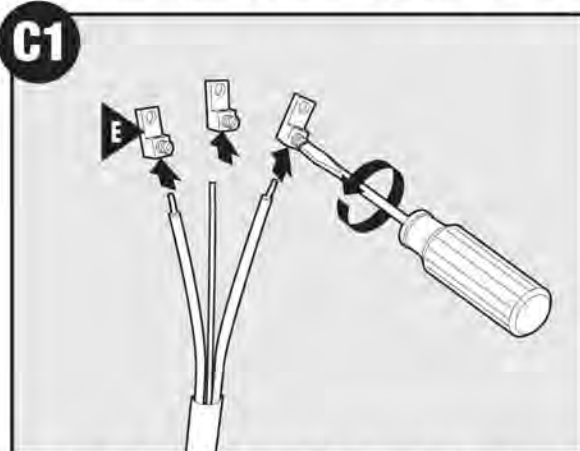

Attach lugs. See Torque specifications at right./Fixez les tenons. Consultez les spécifications de couple de serrage qui se trouvent à droite./Coloque las tuercas. Vea las especificaciones de torque a la derecha.

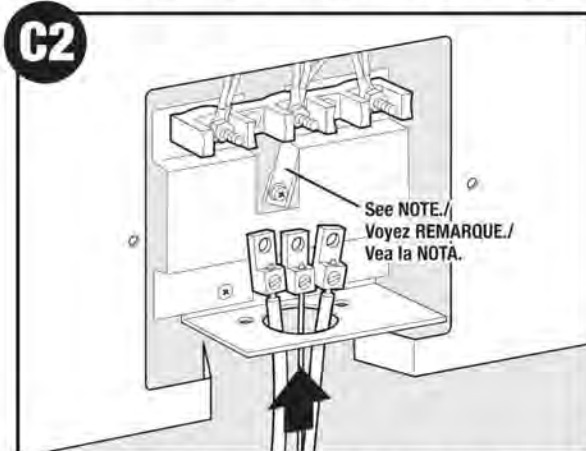

Pull conduit through./Passez le conduit./Tire del conducto a través del agujero.

Installation Instructions

Bare 3-Wire Connection (cont.) / Raccordement - 3 fils dénudés (suite) / Conexión trifilar (cont.) descubierta

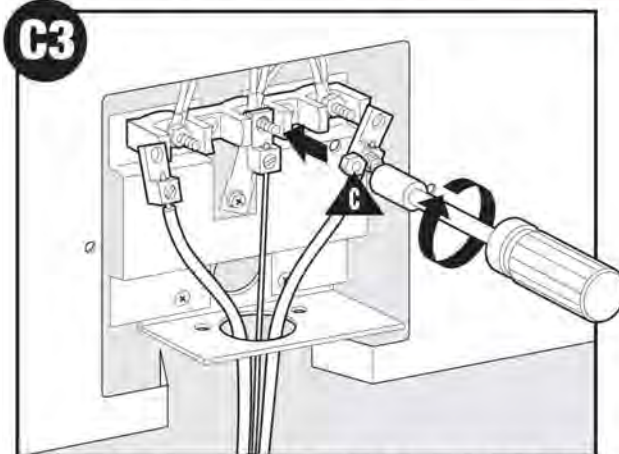

C3
Ground wire **MUST** connect to middle post./Le fil de mise à la terre **DOIT** être connecté à la borne centrale./El alambre de tierra **DEBE** conectarse al conector central.

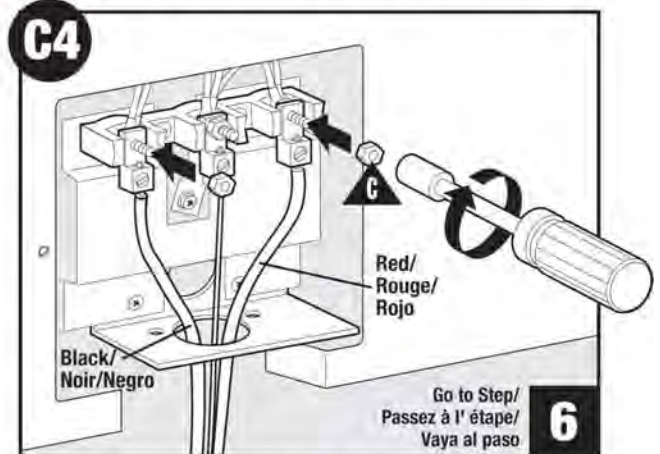

C4
Connect remaining wires./Raccordez les autres fils./Conecte los alambres restantes./

Bare Wire Torque Specifications Lug attached to Terminal Block - 20 in-lb	
Fils dénudés - caractéristiques de couple Cosse fixée à la plaque à bornes - 20 lb-po	
Especificaciones del torque para los alambres desforrados Tuerca fijada al tablero de terminales - 20 pulg-lb	
Wire AWG/Fil AWG/Clasificación AWG del alambre	Torque/Couple/Torque
10 - 14	20 in-lb/20 lb-po/20 pulg-lb
8	25 in-lb/25 lb-po/25 pulg-lb
4 - 6	35 in-lb/35 lb-po/35 pulg-lb

NOTE: The copper ground strap **MUST** stay connected between middle post and range.

REMARQUE : La bande en cuivre de mise à la terre **DOIT** rester connectée entre la borne centrale et la cuisinière.

NOTA: La cinta de cobre de puesta a tierra **DEBE** permanecer conectada entre el conector central y la estufa.

Bare 4-Wire Connection/Raccordement - 4 fils dénudés/Conexión tetrafilar descubierta

Note: Conduit users should refer to special option steps on the last page./**Remarque :** Les utilisateurs de conduits devraient se reporter aux étapes pour les options spéciales de la dernière page./**Nota:** Si va a utilizar un conducto, consulte los pasos opcionales especiales en la última página.

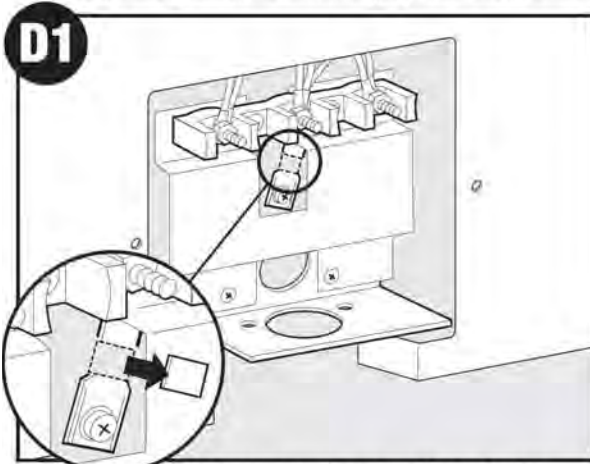

D1
Part of copper ground strap **MUST** be cut out and removed./Une partie de la bande en cuivre de mise à la terre **DOIT** être coupée et enlevée./Una parte o la totalidad de la cinta de conexión a tierra **DEBE** ser cortada y descartada.

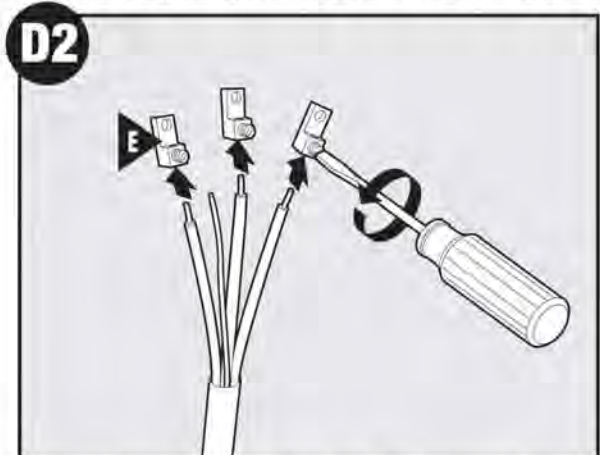

D2
Attach lugs. See Torque specifications above./Fixez les cosSES à vis. Caractéristiques de couple au-dessus./Fije las tuercas. Consulte las especificaciones del torque arriba.

Installation Instructions

Bare 4-Wire Connection (cont)/Raccordement - 4 fils dénudés (suite) /Conexión tetrafilar descubiertan (cont)

D3

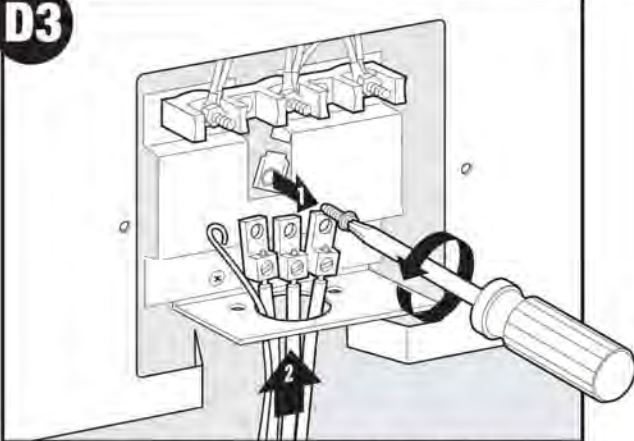

Remove grounding screw, pull conduit through. Retirez la vis de mise à la terre, passez le conduit. Retire el tornillo de puesta a tierra y tire del conducto a través del agujero.

D4

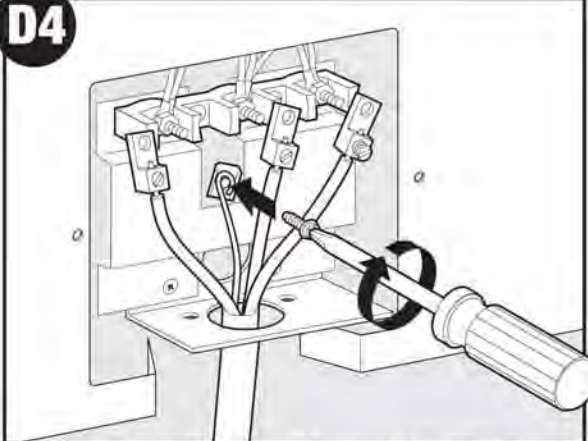

Connect ground wire. /Raccordez le fil de mise à la terre. /Conecte el alambre de tierra.

D5

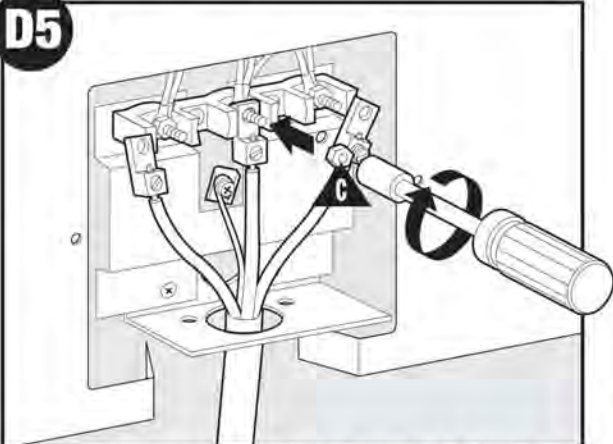

Connect white neutral wire to middle post. /Raccordez le fil blanc du neutre à la borne centrale. /Conecte el alambre blanco del neutro al conector central.

D6

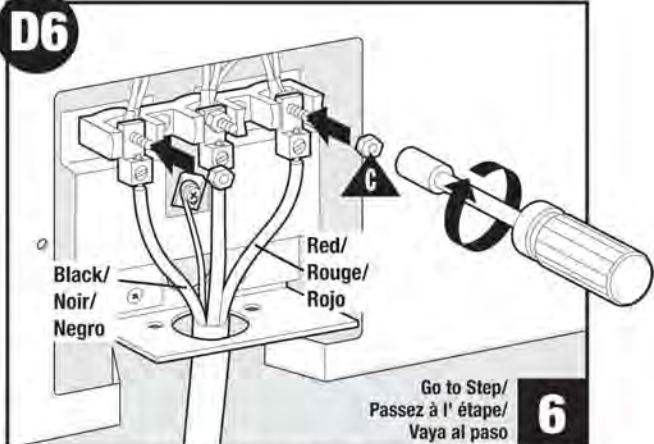

Connect remaining wires. /Raccordez les fils restants. /Conecte los alambres restantes.

Go to Step/
Passez à l'étape/
Vaya al paso **6**

Install Strain Relief for 3 or 4-Wire Connection/Installez le dispositif anti-étrirage pour le raccordement de 3 ou 4 fils Instale el liberador de tensión para la conexión trifilar o tetrafilar.

Note: Strain relief for service cord or conduit **MUST** be attached to the conduit plate. /Remarque : Le dispositif anti-étrirage pour le cordon d'alimentation ou le conduit **DOIT** être fixé à la plaque du conduit. /Nota: El liberador de tensión para el cordón de servicio o para el conducto **DEBE** estar fijado a la placa del conducto.

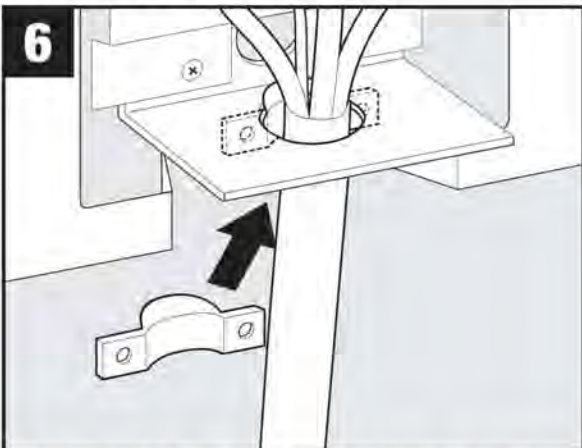

Position rear strain relief. /Placez la bride arrière du dispositif anti-étrirage. /Coloque el liberador de tensión trasero en su lugar.

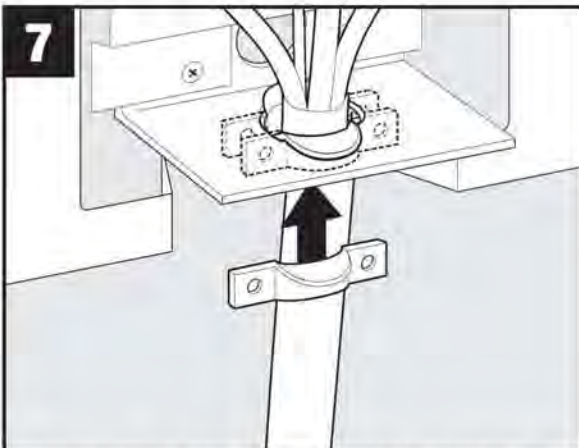

Position front strain relief. /Placez la bride avant du dispositif anti-étrirage. /Coloque el liberador de tensión delantero en su lugar.

Installation Instructions

Install Strain Relief for 3 or 4-Wire Connection (cont.)/Installez le dispositif anti-étrirage pour le raccordement de 3 ou 4 fils (suite)/Instale el liberador de tensión para la conexión trifilar o tetrafilar. (cont.)

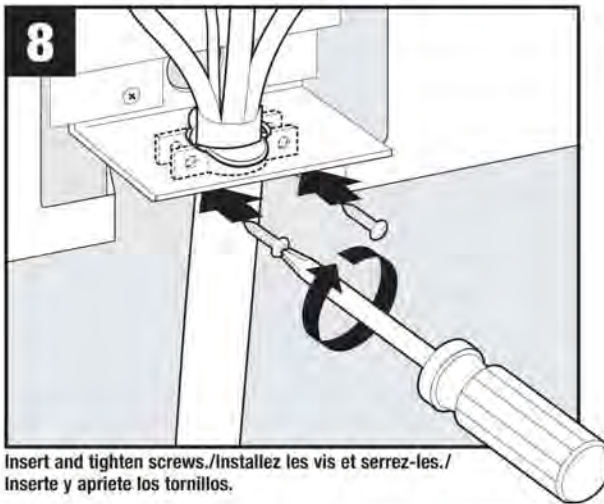

Insert and tighten screws./Installez les vis et serrez-les./
Inserte y apriete los tornillos.

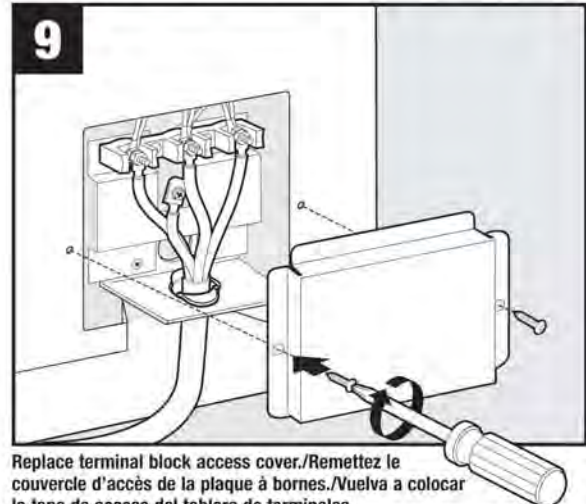

Replace terminal block access cover./Remettez le couvercle d'accès de la plaque à bornes./Vuelva a colocar la tapa de acceso del tablero de terminales.

Gas Line Installation/Installation de la conduite de gaz/Instalación de la tubería de gas

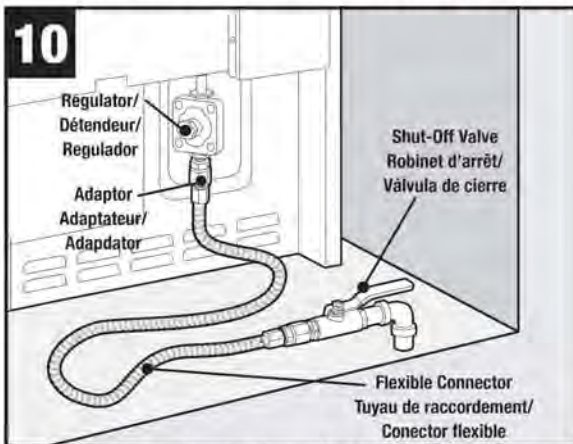

Only qualified personnel should install range. Must be installed in accordance with local codes. See instructions in front of this manual./Seul du personnel qualifié doit installer la cuisinière. Elle doit être installée selon les codes locaux. Voyez les instructions au début de ce manuel./La estufa sólo debe ser instalada por personal calificado. La estufa debe instalarse de acuerdo con los códigos locales. Vea las instrucciones en la parte delantera de este manual.

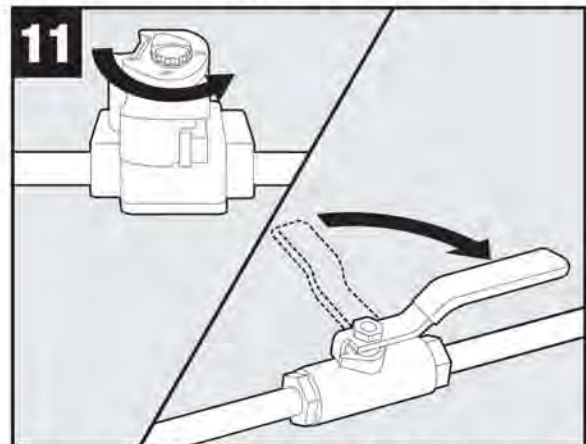

Turn on gas supply shut-off valve./Ouvrez le robinet de l'alimentation en gaz./Abra la válvula de cierre del gas.

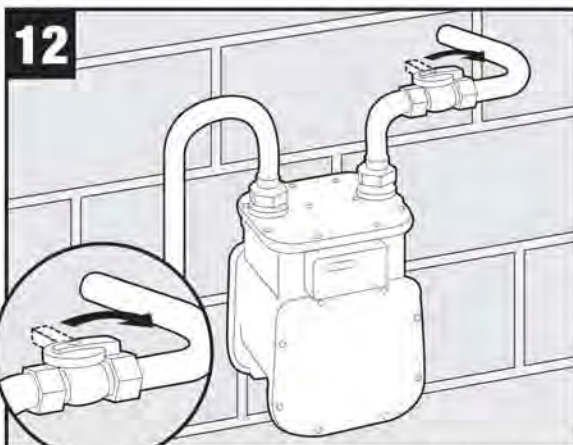

Turn on main gas valve at meter./Ouvrez le robinet principal au niveau du compteur./Abra la válvula de gas en el medidor.

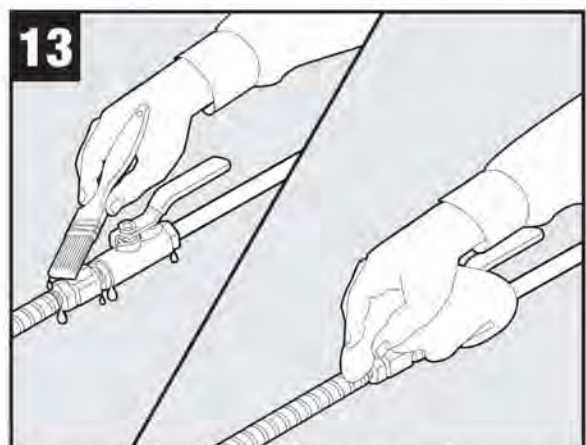

Check all gas connection joints and fittings for leaks with a non-corrosive leak detection fluid, then wipe off./Vérifiez l'absence de fuite à tous les raccordements de gaz avec un liquide de détection des fuites non corrosif, puis essuyez-le./ Verifique todas las conexiones y juntas del suministro de gas a la estufa usando un líquido de detección de escapes no corrosivo para asegurarse de que no hayan escapes. Limpie el líquido cuando haya terminado.

Installation Instructions

Anti-tip installation/Installation de la bride antibasculement/Instalación antivuelco

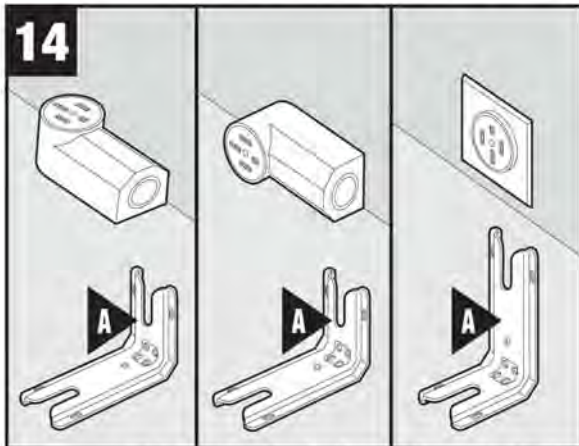

Locate power outlet and position bracket. Go to 14a for wood or 14b for concrete./Repérez la prise d'alimentation et positionnez la bride. Passez à 14a pour le bois ou à 14b pour le béton./Ubique el tomacorriente y coloque el soporte en posición. Vaya al paso 14a para instalación en madera y al paso 14b para instalación en concreto.

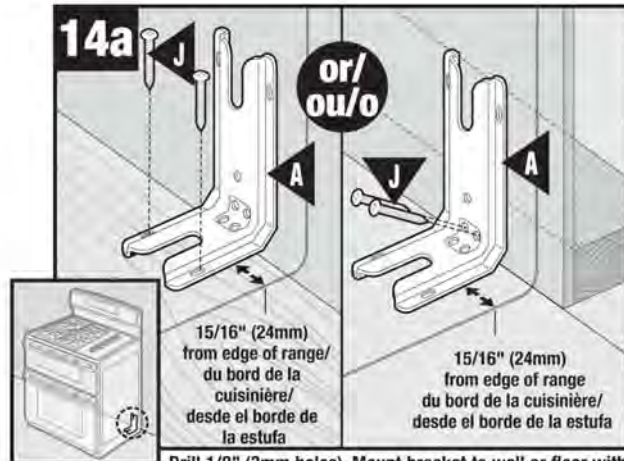

Drill 1/8" (3mm holes). Mount bracket to wall or floor with 2 screws./Percez des trous de 1/8 po (3 mm). Installez le support ANTIREVERSEMENT au mur ou au sol avec deux vis./Taladre agujeros de 1/8" (3 mm). Instale el soporte ANTIVUELCO en la pared o en el piso usando 2 tornillos.

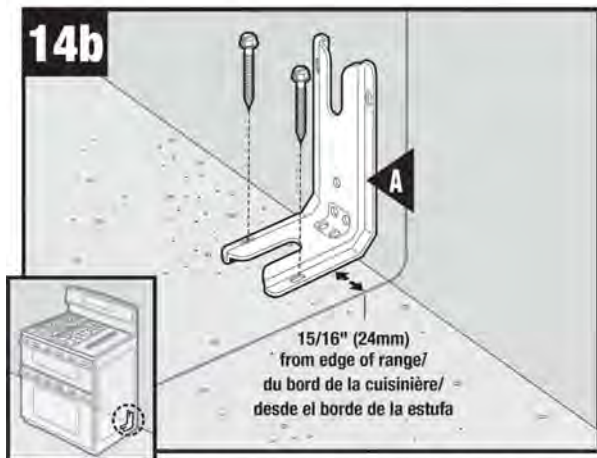

Drill holes as required. Mount bracket to floor with 2 concrete screws (not provided)./Percez des trous selon le besoin. Installez le support ANTIREVERSEMENT au sol avec deux vis à béton (non fournies)./ Taladre los agujeros que necesite. Instale el soporte ANTIVUELCO en el piso usando 2 tornillos para concreto (no proporcionados).

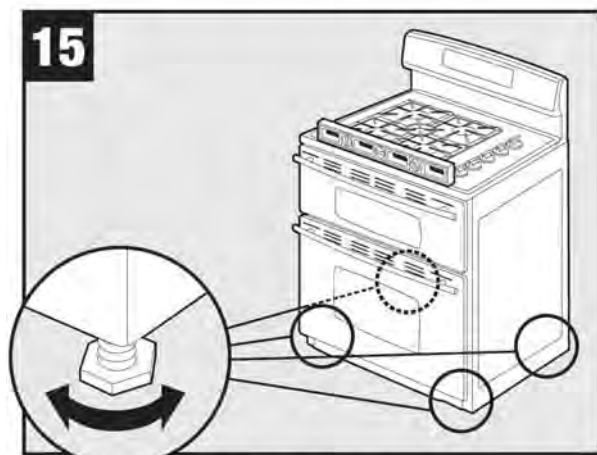

Adjust legs./Ajustez les pieds./Ajuste los tornillos niveladores.

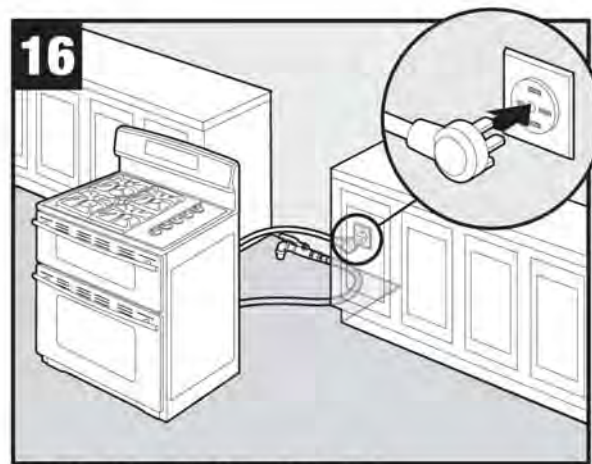

Insert plug./Insérez la fiche/Conecte el enchufe.

Installation Instructions

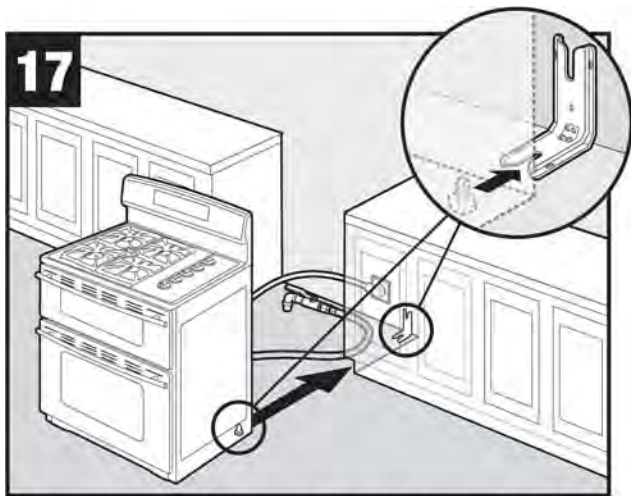

17 Slide range into position./Repoussez la cuisinière en place/Deslice la estufa a su lugar definitivo.

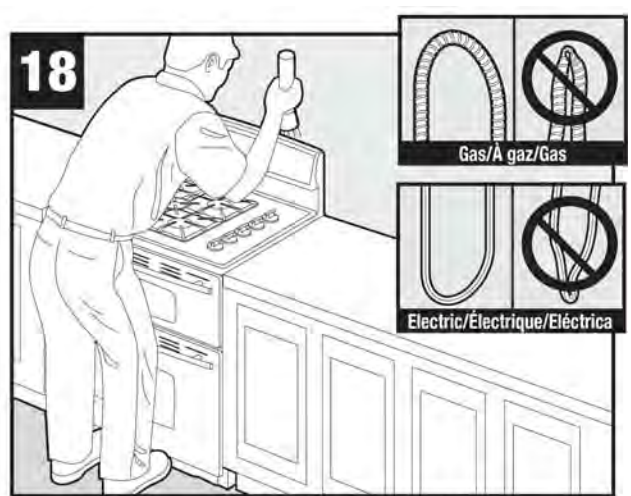

18 Make sure flexible connector and electrical cord are not bent./Assurez-vous que le tuyau de raccordement flexible et le cordon électrique ne sont pas pliés./Asegúrese de que el conector flexible y el cordón eléctrico no estén doblados.



19 Check leg position in bracket./Vérifiez que le pied est bien sous la bride./ Verifique la posición del tornillo en el soporte.

Final installation/Installation finale/Instalación definitiva

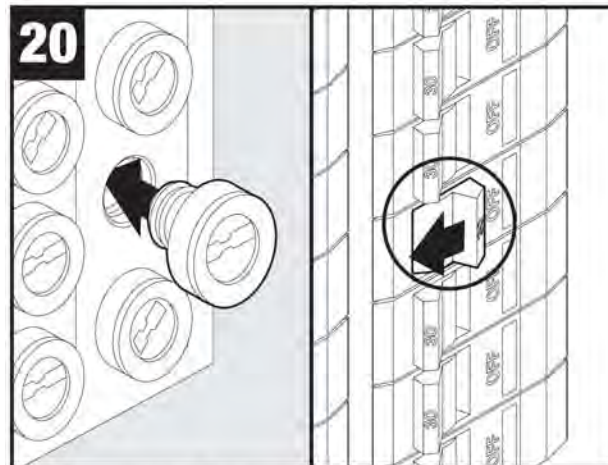

20 Turn on power source./Ouvrez le courant./Encienda el suministro eléctrico.

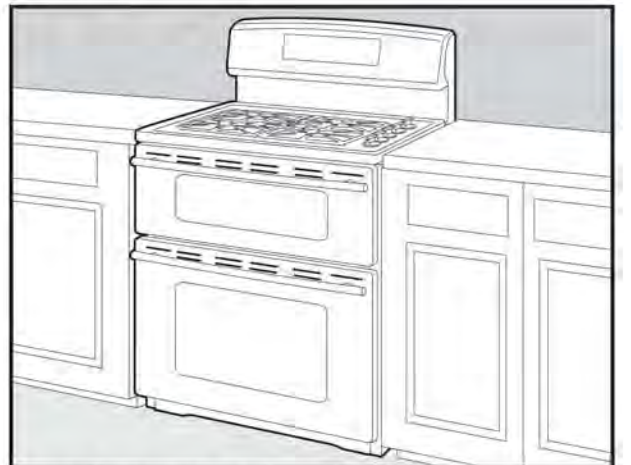

Complete./Terminez./Completo.

Installation Instructions

IMPORTANT: Keep for Local Inspector/IMPORTANT : À conserver pour l'inspecteur local/ IMPORTANTE: Guarde esta información para el inspector local.

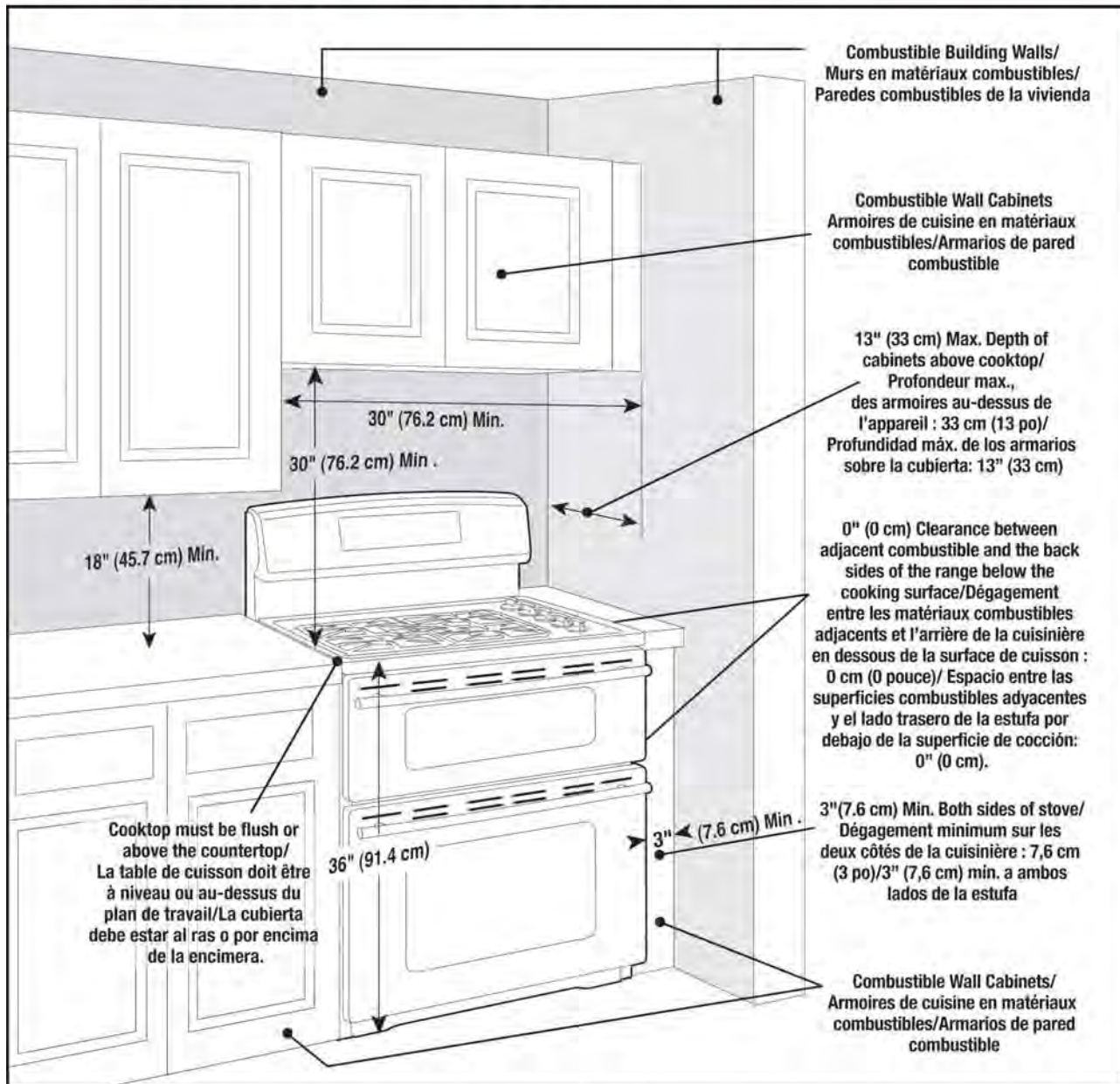

NOTE: Figure may not be representative of actual unit./REMARQUE : L'illustration peut ne pas présenter l'appareil actuel./NOTA: La figura puede no ser exacta a la unidad.

CLEARANCE DIMENSIONS

Range may be installed with zero inches clearance adjacent to (against) combustible construction at the rear and on the sides below the cooktop. For complete information in regard to the installation of wall cabinets above the range and clearances to combustible wall above the cooking top see the installation drawings. For SAFETY CONSIDERATIONS do not install a range in any combustible cabinetry which is not in accord with the installation drawings.

* **NOTE:** 30 inch (76.2 cm) dimension between cooking top and wall cabinet shown on illustration does not apply to ranges with an elevated oven or microwave. The installation instructions of the elevated oven will specify the minimum acceptable dimension between the cooktop and elevated oven. The 30 inch (76.2 cm) dimension may be reduced to not less than 24 inches (61 cm) when the wall cabinets in a domestic home are protected with fireproof materials in accordance with American National Standards - National Fuel Gas Code or in mobile homes when they are protected with fireproof materials in accordance with the Federal Standard for Mobile Home Construction and Safety.

To eliminate the risk of burns or fire by reaching over heated surface units, cabinet storage space located above the surface units should be avoided. If cabinet storage is to be provided, the risk can be reduced by installing a range hood that projects horizontally a minimum of 5 inches (13 cm) beyond the bottom of the cabinets

Installation Instructions

IMPORTANT: Keep for Local Inspector (cont) / IMPORTANT : À conserver pour l'inspecteur local (suite) / IMPORTANTE: Guarde esta información para el inspector local. (cont.)

DÉGAGEMENTS

La cuisinière peut être installée avec un dégagement nul contre des matériaux combustibles à l'arrière et sur les côtés en dessous de la table de cuisson. Pour des renseignements complets concernant l'installation des armoires au-dessus de la cuisinière et les dégagements aux parois combustibles au-dessus de la surface de cuisson, consultez les schémas sur l'installation. Pour des RAISONS DE SÉCURITÉ, n'installez pas une cuisinière dans des armoires en matériaux combustibles non conformes aux schémas de l'installation.

***REMARQUE :** La dimension de 76,2 cm (30 po) entre la surface de cuisson et les armoires murales présentées sur l'illustration ne concerne pas les cuisinières avec un four surélevé ou un micro-ondes. Les instructions d'installation du four surélevé précisent la dimension minimale acceptable entre la surface de cuisson et le four surélevé. La dimension de 76,2 cm (30 po) peut être réduite à pas moins de 61 cm (24 po) lorsque les armoires murales d'une résidence sont protégées par des matériaux ignifuges conformément aux normes de l'American National Standards – National Fuel Gas Code (Code national des combustibles gazeux), ou lorsque les armoires murales d'une maison mobile sont protégées par des matériaux ignifuges selon la norme fédérale : Mobile Home construction and Safety (norme de sécurité et de construction des maisons mobiles).

Pour éliminer le risque de brûlure ou d'incendie, en passant la main au-dessus des éléments de surface chauffés, l'espace de rangement dans les armoires situées au-dessus des éléments de surface doit être évité. Si une armoire de rangement existe, le risque peut être réduit en installant une hotte d'extraction qui dépasse horizontalement d'un minimum de 13 cm (5 po) de la partie inférieure des armoires.

DIMENSIONES DE LOS ESPACIOS DE DESPEJE

Esta estufa se puede instalar sin espacios de despeje contra superficies combustibles en la parte trasera y a los costados de la misma por debajo de la cubierta. Para obtener información completa sobre la instalación de los armarios sobre la cubierta y los espacios de despeje para las paredes combustibles sobre la cubierta vea las figuras de instalación. Por RAZONES DE SEGURIDAD, no instale una estufa en ninguna ubicación con armarios combustibles que no concuerden con las figuras de instalación.

***NOTA:** El despeje de 30 pulgadas (76,2 cm) entre la cubierta de cocción y el armario que se muestra en la figura no se aplica a las estufas con hornos elevados o a los microondas. Las instrucciones de instalación del horno elevado especificarán el espacio mínimo entre la cubierta y el horno elevado. El despeje de 30 pulgadas (76,2 cm) puede ser reducido a no menos de 24 pulgadas (61 cm) cuando los armarios del hogar están protegidos con materiales a prueba de fuego de acuerdo con las Normas Nacionales de Estados Unidos (ANS) y el Código Nacional de Gas o en las casas rodantes cuando las mismas están protegidas con materiales a prueba de fuego de acuerdo con la Norma Federal de Construcción y Seguridad de Viviendas Móviles.

Para eliminar el riesgo de quemaduras o de incendios cuando se intenta alcanzar algún objeto sobre los elementos superiores, evite almacenar artículos en los armarios que están sobre la estufa. Si se instala un armario sobre la cubierta, se puede reducir el riesgo instalando una campana de ventilación que se proyecte horizontalmente en un mínimo de 5 pulgadas (13 cm) más allá de la base de los armarios.

A W A R N I N G

THIS PRODUCT SHOULD NOT BE INSTALLED BELOW VENTILATION TYPE HOOD SYSTEM THAT DIRECTS AIR IN A DOWNWARD DIRECTION. THESE SYSTEMS MAY CAUSE IGNITION AND COMBUSTION PROBLEMS WITH THE GAS BURNERS RESULTING IN PERSONAL INJURY AND MAY EFFECT THE COOKING PERFORMANCE OF THE UNIT.

NOTE: THE FIGURE MAY NOT ACCURATELY REPRESENT YOUR RANGE COOKTOP; HOWEVER, THIS WARNING APPLIES TO ALL GAS COOKING PRODUCTS.

AVERTISSEMENT : CE PRODUIT NE DOIT PAS ÊTRE INSTALLÉ SOUS UNE HOTTE D'EXTRACTION QUI RENVOIE L'AIR VERS LE BAS.

CES SYSTÈMES PEUVENT ENTRAÎNER DES PROBLÈMES D'INFLAMMATION ET DE COMBUSTION AVEC LES BRÔLEURS À GAZ, ENTRAÎNANT DES BLESSURES ET RISQUANT D'AFPECTER LA PERFORMANCE DE CUISSON DE L'APPAREIL.

REMARQUE : L'ILLUSTRATION PEUT NE PAS REPRÉSENTER PRÉCISÉMENT LA TABLE DE CUISSON DE VOTRE CUISINIÈRE; CEPENDANT, CET AVERTISSEMENT CONCERNE TOUS LES APPAREILS DE CUISSON À GAZ.

ADVERTENCIA: ESTE PRODUCTO NO SE DEBE INSTALAR DEBAJO DE SISTEMAS DE CAMPANAS DE VENTILACIÓN QUE DIRIJAN EL FLUJO DE AIRE HACIA ABAJO.

ESTOS SISTEMAS PUEDEN CAUSAR PROBLEMAS DE ENCENDIDO Y DE COMBUSTIÓN DE LOS QUEMADORES, LO QUE PUEDE RESULTAR EN LESIONES PERSONALES Y AFECTAR EL RENDIMIENTO DE LA COCCIÓN DE LA UNIDAD.

NOTA: LA FIGURA PUEDE NO REPRESENTAR CON EXACTITUD SU CUBIERTA. SIN EMBARGO, ESTA ADVERTENCIA SE APLICA A TODOS LOS PRODUCTOS DE COCCIÓN A GAS.



Appendix B

SURFACE COOKING

Suggested Heat Settings

Low: Use to simmer foods, keep foods warm and melt chocolate or butter. Some cooking may take place on the **Low** setting if the pan is covered. Be sure flame is stable.

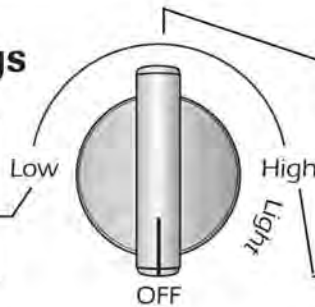

An intermediate flame size is used to continue cooking. Food will not cook any faster when a higher flame setting is used than needed to maintain a gentle boil. Water boils at the same temperature whether boiling gently or vigorously.

High: Use to bring liquid to a boil, or reach pressure in a pressure cooker. Always reduce setting to a lower heat when liquids begin to boil or foods begin to cook.

Surface Controls

⚠ CAUTION

- If flame should go out during a cooking operation, turn the burner off. If a strong gas odor is detected, open a window and wait five minutes before relighting the burner.
- Be sure all surface controls are set in the **OFF** position prior to supplying gas to the range.
- **NEVER** touch cooktop until it has cooled. Expect some parts of the cooktop, especially around the burners, to become warm or hot during cooking. Use potholders to protect hands.

Pilotless Ignition

Pilotless ignition eliminates the need for a constant standing pilot light. Each surface burner has a spark ignitor. Use care when cleaning around the surface burner.

If the surface burner does not light, check if ignitor is broken, soiled or wet.

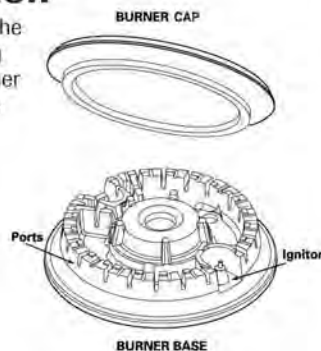

Surface Control Knobs

Use to turn on the surface burners. An infinite choice of heat settings is available from **Low** to **High**. The knobs can be set on or between any of the settings.

Graphics next to the knob identify which burner the knob controls. For example, the graphic at left shows the right front burner location.



Setting the controls:

The size and type of cookware will affect the heat setting. For information on cookware and other factors affecting heat settings, refer to "Cooking Made Simple" booklet.

1. Place a pan on the burner grate.
 - The burner flame may lift off or appear separated from the port if a pan is not placed on the grate.
2. Push in and turn the knob counterclockwise to the **Light** setting.
 - A clicking (spark) sound will be heard and the burner will light. (All five ignitors will spark when any surface burner knob is turned to the **Light** position.)
3. After the burner lights, turn knob to desired flame size.
 - The ignitor will continue to spark until the knob is turned past the **Light** position.
4. After cooking, turn knob to **OFF**. Remove pan.

Operating During a Power Failure

⚠ CAUTION

When lighting the surface burners, be sure all of the controls are in the **OFF** position. Strike the match first and hold it in position before turning the knob to **Light**.

1. Hold a lighted match to the desired surface burner head.
2. Push in and turn the control knob slowly to **Light**.
3. When the burner lights, adjust the flame to the desired level.

SURFACE COOKING

Cooktop

To prevent the cooktop from discoloring or staining:

- Clean cooktop after each use.
- Wipe acidic or sugary spills as soon as the cooktop has cooled as these spills may discolor the porcelain.



Unlike a range with standard gas burners, this cooktop does not lift-up nor is it removable. **Do not attempt to lift the cooktop for any reason.**

Sealed Burners

The sealed burner bases of your range are secured to the cooktop and are not designed to be removed. Since the burners are sealed into the cooktop, boilovers or spills will not seep underneath the cooktop.

However, the burner base should be cleaned after each use. The head portion of the burner has a cap that is easily removed for cleaning. (See page 21 for cleaning directions.)

Burner caps must be correctly placed on the burner base for proper operation of the burner.

High Performance Burner

There is one 16,000 BTU* high speed burner on your range, located in the left front position. There is a 12,000 BTU* burner located in the right front position. These burners offer higher speed cooking that can be used to quickly bring water to a boil and for large-quantity cooking.

Simmer Burner

This burner is located in the center position. The simmer burner offers a lower BTU flame for delicate sauces or melting chocolate.

* BTU ratings will vary when using LP gas.



Burner Grates

The grates must be properly positioned before cooking. Lower the grates onto the range so that the bars match up and the rubber feet located at the four corners of the grates sit in the indentations on the cooktop.

Improper installation or removal of the grates may result in chipping or scratching of the cooktop. It may also cause pans to be unsteady on the grates.

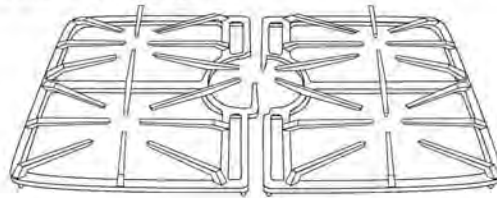

Do not operate the burners without a pan on the grate. The grate's porcelain finish may chip without a pan to absorb the heat from the burner flame.

Use care when stirring food in a pot/pan sitting on the burner grate. The grates have a smooth finish for ease of cleaning. The pot/pan will slide if the handle is not held. This may result in spilling of hot food items and may be a burn hazard.

Although the burner grates are durable, they will gradually lose their shine and/or discolor, due to the high temperatures of the gas flame.

Notes:

- A properly adjusted burner with clean ports will light within a few seconds. If using natural gas, the flame will be blue with a deeper blue inner cone. If the burner flame is yellow or is noisy, the air/gas mixture may be incorrect. Contact a service technician to adjust. (Adjustments are not covered by the warranty.)
With LP gas, slight yellow tips on the flames are acceptable. This is normal and adjustment is not necessary.
- With some types of gas, you may hear a "popping" sound when the surface burner is turned off. This is a normal operating sound of the burner.
- If the control knob is turned very quickly from **High** to **Low**, the flame may go out, particularly if the burner is cold. If this occurs, turn the knob to the **OFF** position, wait several seconds and relight the burner.
- The flame should be adjusted so it does not extend beyond the edge of the pan.



OVEN COOKING

Control Panel

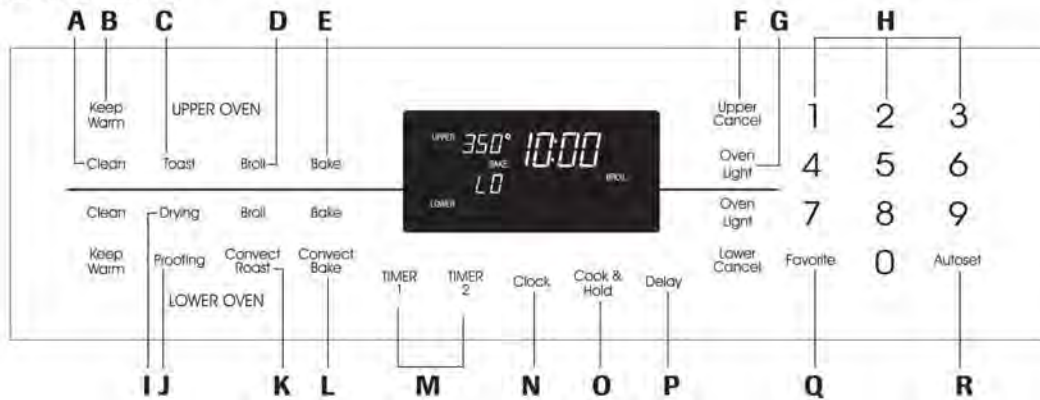

The control panel is designed for ease in programming. The display window on the control shows time of day, timer and oven functions. Control panel shown includes Convection and other model specific features. (Styling may vary depending on model.)

A	Clean	Use to set self-clean cycle.
B	Keep Warm	Use to keep cooked food warm in oven.
C	Toast	Use for toasting bread and products toasted in toaster or toaster oven.
D	Broil	Use for broiling and top browning.
E	Bake	Use for baking and roasting.
F	Cancel	Cancels all operations except Timer and Clock.
G	Oven Light	Use to turn the upper or lower oven light on or off.
H	Number Pads	Use to set time and temperature.
I	Drying	For drying fruits, vegetables and herbs.
J	Proofing	For proofing or allowing yeast bread products to rise prior to baking.
K	Convection Roast	Use for convection roasting.
L	Convection Bake	Use for convection baking.
M	Timer 1 or 2	Sets the timer.
N	Clock	Sets the clock.
O	Cook & Hold	Bakes for a preset time, then keeps food warm for 1 hour.
P	Delay	Programs the oven to start baking or cleaning at a later time.
Q	Favorite	Use to set and save a specific Cook & Hold procedure.
R	Autoset	Use to quickly set temperatures.

Note: Four seconds after entering the time or temperature it will automatically be entered. If more than 30 seconds elapse between touching a function pad and the number pads, the function will be canceled and the display will return to the previous display.

Clock

The clock can be set to display time in a 12-hour or 24-hour format. The clock is set at the factory for the 12-hour format.

To change the clock to 24-hour format:

1. Press and hold the Upper Cancel pad and Favorite pad for three seconds.
 - 12 Hr flashes in the display.
2. Press the Autoset pad to select 24 Hr; press again to select 12 Hr.
3. Set the time of day following the directions in the To Set the Clock section.

Upper Cancel

Favorite

Autoset

To set the Clock:

1. Press the Clock pad.
 - The time of day flashes in the display.
 - Colon flashes in the display.
2. Press the appropriate number pads to set the time of day.
3. Press the Clock pad again or wait four seconds.
 - The colon will remain on.

Clock

When electrical power is supplied or after a power interruption, the last clock time before power was interrupted will flash.

To recall the time of day when another time function is showing, press the Clock pad

Using the Touchpads

- Press the desired pad.
- Press the number pads to enter time or temperature.
- Or, press the Autoset pad to enter temperature.
- A beep will sound when any pad is touched.
- A double beep will sound if a programming error occurs.

OVEN COOKING

To cancel the Clock display:

If you do not want the time of day to display:

Press and hold the Upper Cancel and Clock pads for three seconds. The time of day will disappear from the display.

When the clock display is canceled, press the Clock pad to briefly display the time of day.

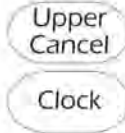

To restore the Clock display:

Press and hold the Upper Cancel and Clock pads for three seconds. The time of day will reappear in the display.

Timer

Each timer can be set from one minute (00:01) up to 99 hours and 59 minutes (99:59).

The timers can be used independently of any other oven activity. They can also be set while another oven function is operating.

The Timers do not control the oven.

To set the Timer 1 or 2:

1. Press the Timer 1 or 2 pad.
 - 00:00 and TIMER 1 or 2 flash in the display.
2. Press the appropriate number pads until the correct time appears in the display.
 - TIMER 1 or TIMER 2 will be displayed. If both timers are active, TIMER 1 and TIMER 2 will be displayed.
 - The colon and TIMER 1 and/or 2 will continue to flash.
3. Press Timer pad again or wait four seconds.
 - The colon stops flashing and the time begins counting down.
 - The last minute of the timer countdown will be displayed in seconds.
4. At the end of the set time, one long beep will sound and "End" will be displayed.
5. Press the Timer pad to clear the display.

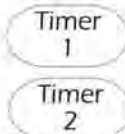

To cancel the Timer:

1. Press and hold the corresponding Timer pad for three seconds.
OR
2. Press the Timer pad and press '0' using the number pads.

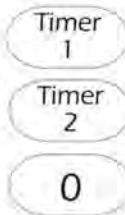

Locking the Control and Oven Doors

The touchpad and oven doors can be locked for safety, cleaning, or to prevent unwanted use. The touchpads will not function when locked.

If the oven is currently in use, the touchpads and doors cannot be locked.

The current time of day will remain in the display when the touchpads and doors are locked.

To lock both doors:

1. Press and release Cancel pad.
2. Press and hold the Upper Cancel and Cook & Hold pads for three seconds.
 - OFF appears in the display
 - LOCK flashes while the doors are locking. Both oven doors lock. LOCK remains in the display.



To unlock both doors:

Press and hold the Upper Cancel and Cook & Hold pads for three seconds. OFF disappears from the display and LOCK flashes while the doors are unlocking.

Note: The touchpads and oven doors cannot be locked if the oven temperature is 400° F or above.

Fault Codes

BAKE or LOCK may flash rapidly in the display to alert you if there is an error or a problem. If BAKE or LOCK flash in the display, press the Cancel pad. If BAKE or LOCK continue to flash, disconnect power to the appliance. Wait a few minutes, and then reconnect power. If the flashing still continues, disconnect power to the appliance and call an authorized servicer.

Adjusting Sound Level

The factory default setting for sound is medium (MEd), but it can be changed to low (Lo) or high (HI). To change the setting:

1. Press and hold Delay and Upper Cancel pads for three seconds. A beep will sound. "bEEP" and the current sound level ("LO", "MEd" or "HI") will appear in the display.
2. Press the Autoset pad to increase or decrease the sound level.
3. Wait four seconds and the new setting will be accepted.
4. If the Autoset pad is not pressed within 30 seconds, the control will return to the existing setting.

Changing Temp °F/°C

The factory default setting for temperature is Fahrenheit. To change the setting:

1. Press and hold the upper oven Bake and Upper Cancel pads for 3 seconds. A beep will sound and the current setting °F or °C will appear in the display.
2. Press the Autoset pad to change the setting between °F and °C.

OVEN COOKING

3. Wait 4 seconds and the new setting will be accepted.
4. If the Autoset pad is not pressed within 30 seconds, the control will return to the existing setting.

Return To Factory Default Settings

The control can be reset to the factory default settings. To return to the default settings:

1. Press and hold upper oven Keep Warm and Upper Cancel pads for 3 seconds. A single beep will sound and 12:00 will appear in the display.
2. Reset the clock to the current time of day.

Setting Oven Functions

Auto Set Pad

Use with function pads to automatically set:

- 350° F bake temperature
- HI or LO broil
- three hours of cleaning time
- four minutes of toasting time
- 170° F keep warm temperature
- 140° drying temperature
- Standard proofing

Baking

To set Bake:

1. Press the Bake pad for desired oven.
• BAKE and 000 will flash in the display.
2. Select the oven temperature. Press the Autoset pad for 350° F or the appropriate number pads.
• Each additional press of the Autoset pad will increase the temperature by 25°.
• The oven temperature can be set from 170° to 550°.
3. Press Bake pad again or wait four seconds.
• BAKE will stop flashing and light in the display.
• PREHEAT will light in the display and the oven turns on.
• 100° or the actual oven temperature if over 100° F will display. It will rise in 5° increments until the preset temperature is reached.



4. Allow 4-10 minutes for the upper oven to preheat and 7-12 minutes for the lower oven to preheat.
 - When the set oven temperature is reached, one long beep will sound.
 - The set temperature will display.
 - PREHEAT will turn off.
 - To recall set temperature during preheat, press Bake pad.
5. Place food in the oven.
6. Check cooking progress at the minimum cooking time. Cook longer if needed.
7. When cooking is finished, press appropriate Cancel pad.
8. Remove food from the oven.

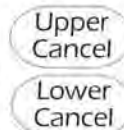

Baking Differences Between Your Old and New Oven

It is normal to notice some baking time differences between a new oven and an old one. See "Adjusting the Oven Temperature" on page 17.

Baking Notes:

- If the lower oven is NOT in use, the upper oven will preheat more quickly.
- **Allow at least 1/2-inch between the baking pan or casserole and the top element in the upper oven.** Loaf, angel food or bundt pans are not recommended in the upper oven.
- Do not use temperatures below 140° F to keep food warm or below 200° F for cooking. For food safety reasons, lower temperatures are not recommended.
- The back part of the lower oven bake element will not glow red during baking. This is normal.
- When baking frozen, self-rise pizza in the upper oven, place the pizza on a cookie sheet to avoid overbrowning.
- When preheating with a baking/pizza stone inside the upper oven, do not set oven above 400° F. To use baking/pizza stones at temperatures above 400° in the upper oven, put stone in after the preheat beep.
- To change the oven temperature during cooking, press the Bake pad, then press the Autoset or appropriate number pads until the desired temperature is displayed.
- **To change the oven temperature during preheat, press the Bake pad twice, then press the Autoset pad or appropriate number pads until the desired temperature is displayed.**
- If you forget to turn off the oven, it will automatically turn off at the end of 12 hours. If you wish to deactivate the Automatic Shut Off/Sabbath Mode feature, see page 16.
- For additional baking and roasting tips, see "Cooking Made Simple" booklet.

OVEN COOKING

Baking with Convection

(lower oven only)

When convection baking, enter your normal baking temperature. The control will automatically reduce the set oven temperature by 25° (even though normal baking temperature is displayed).

To set Convect Bake:

1. Press the Convect Bake pad.
 - LOWER BAKE and the FAN icon will flash.
 - 000 will flash in the display.
2. Select the oven temperature. Press the AutoseT pad for 350° F or the appropriate number pads.
 - Each additional press of the AutoseT pad will increase the temperature by 25 degrees. The oven temperature can be set from 170° to 550°.
3. Press Convect Bake pad again or wait four seconds.
 - LOWER BAKE will stop flashing.
 - PREHEAT and LOWER will light in the display.
 - 100° or the actual oven temperature if over 100° F will display. It will rise in 5° increments until the preset temperature is reached.
 - The FAN icon will start to rotate.
4. Allow the oven to preheat for 7-12 minutes.
 - When the set oven temperature is reached, one long beep will sound and PREHEAT will turn off.
 - The set temperature will display.
 - To recall the set temperature during preheat, press the Convect Bake pad.

Convect
Bake

AutoseT



5. Place food in the oven.
6. Check cooking progress at the minimum cooking time. Cook longer if needed.
7. When cooking is finished, press Lower Cancel pad.
8. Remove food from the oven.

Lower
Cancel

Roasting With Convection

(lower oven only)

When convection roasting, enter your normal roasting time and temperature. The control will automatically prompt you to check the food for doneness at 75% of the set time.

Convect Roast Notes:

- When convection roasting, the cooking time must be set before setting the temperature.
- If your recipe requires a preheated oven, add 15 minutes to the cooking time programmed.
- Roasting times can vary with different cuts of meat.
- It is not necessary to preheat when convect roasting large cuts of meat.
- Refer to "Cooking Made Simple" booklet for suggested roasting temperatures and times.

To set Convect Roast:

1. Press the Convect Roast pad.
 - LOWER ROAST, the FAN icon and 00:00 will flash in the display.
 - 000 lights in the display.
2. Enter the roasting time using the number pads.
 - Time can be set from 10 minutes (00:10) to 11 hours, 59 minutes (11:59).
 - Press Convect Roast again or wait 4 seconds.
 - LOWER ROAST and the fan icon flash in the display.
 - 000 will flash in the display.
3. Select the oven temperature. Press the AutoseT pad for 325° F or the appropriate number pads. (Refer to Cooking Made Simple for roasting times.)
 - Each additional press of the AutoseT pad will increase the temperature by 25°.
 - The oven temperature can be set from 170° to 550°.
4. Press Convect Roast pad again or wait four seconds.
 - ROAST will stop flashing and light in the display.
 - 100° or the actual oven temperature will display. It will rise in 5° increments until the preset temperature is reached.
 - The FAN icon will start to rotate.

Convect
Roast

AutoseT



5. Place food in the oven.
 - Time will begin counting down once the oven starts heating up.
 - To recall the set temperature during preheat, press the Convect Roast pad.

cont.

OVEN COOKING

- When 75% of the set cooking time has elapsed, the oven will signal you to check the cooking progress. Check the cooking progress at this time. Cook longer if needed.
 - The oven light will remain on until the Oven Light pad is pressed.
 - Press any pad to recall the cook time remaining.
- When cooking is finished, press Lower Cancel pad.
- Remove food from the oven.

Lower
Cancel

Cook & Hold

When using the **Cook & Hold** feature, the oven begins to heat immediately after the control has been set. Then, the oven cooks for a specified length of time. When that time has elapsed, the oven will keep the food warm for up to one hour then automatically turn off.

To set Cook & Hold:

- Press the Cook & Hold pad **once** for upper oven or **twice** for lower oven.
 - HOLD will flash to indicate that you are in Cook & Hold programming.
 - 00:00 and either UPPER or LOWER will flash in the display.
- Select the amount of time you want to cook by using the number pads.
 - HOLD continues to flash.
 - The time will light in the display.
 - Time can be set from 00:10 to 11:59.
- Press Bake, Convect Bake or Convect Roast (lower oven only) and select the oven temperature. Press the Autoset pad for 350° F or the appropriate number pads.
 - The desired function, 000 and either UPPER or LOWER will flash.
 - The oven temperature can be set from 170° F to 550° F.
- Press the desired function pad again OR wait four seconds.
 - The desired function will remain lit.
 - The cooking time will show in the display.
 - PREHEAT will show in the display.
 - The actual oven temperature will be displayed during preheat.
 - The set temperature will display when the oven is preheated.

Cook &
Hold

Bake

Autoset

When the cooking time has elapsed:

- Four beeps will sound.
- WARM and HOLD will light.
- 170 appears in the display.



After one hour in WARM HOLD:

- The oven turns off automatically.
- Press Cancel pad and remove food from the oven.

To cancel Cook & Hold at any time:

Press the appropriate Cancel pad. Remove food from oven.

Upper
Cancel

Lower
Cancel

Delay Cook & Hold

CAUTION

Do not use delayed baking for highly perishable foods such as dairy products, pork, poultry, or seafood.

When using **Delay**, the oven begins to cook later in the day. Set the amount of time that you want to delay before the oven turns on and how long you want to cook. The oven begins to heat at the selected time and cooks for the specified length of time, then keeps food warm for one hour.

Delay time can be set from 10 minutes (00:10) to 11 hours, 59 minutes (11:59).

To set a Delayed Cook & Hold cycle:

- Press the Delay pad **once** to program the upper oven or **twice** to program the lower oven.
 - DELAY flashes in the display.
 - 00:00 and either UPPER or LOWER flashes in the display.
- Using the appropriate number pads, enter the amount of time you want to delay the start of the Cook & Hold cycle.
- Press the Cook & Hold pad.
 - HOLD flashes.
 - DELAY flashes in the display.
 - 00:00 and either UPPER or LOWER flash.
- Enter the amount of time you want to cook using the number pads.
- Press Bake (upper or lower oven), Convect Bake or Convect Roast (lower oven only).
- Set the oven temperature desired by pressing the Autoset pad or the appropriate number pads.
 - 350° will light when Autoset is pressed.
 - After four seconds, the entered delay time will appear in the display.
 - BAKE and DELAY remain lit to remind you that a delayed Cook & Hold operation has been programmed.

Delay

Cook &
Hold

Autoset

Notes:

- Do not use Delayed Cook & Hold for items that require a preheated oven, such as cakes, cookies, and breads.
- Do not use Delayed Cook & Hold if oven is already hot.

OVEN COOKING

Broiling

To set Broil:

- Press the Broil pad for desired oven.
 - BROIL, UPPER or LOWER and SET will flash in the display.
- Press the Autoset pad **once** to set HI broil or **twice** to set LO broil.
 - HI or LO will be displayed.
- After four seconds, the oven will start.
 - BROIL and HI or LO will remain lit.

Broil

Autoset



- For optimum browning, preheat broil element for 3-4 minutes before adding food.
- Place food in the oven. Leave oven door open about four inches (the first stop).
- Turn meat once while cooking.
- When food is cooked, press the appropriate Cancel pad. Remove food and broiler pan from the oven.

Upper Cancel

Broil Notes:

- For best results when broiling, use a two-piece broiler pan.
- HI** broil is used for most broiling. Use **LO** broil when broiling longer cooking foods to allow them to cook to well done stage without excessive browning.
- Broil times may be longer when the lower broiling temperature is selected.
- Never cover broiler pan insert with aluminum foil. This prevents fat from draining to the pan below.
- Expect broil times to increase and browning to be slightly lighter if appliance is installed on a 208-volt circuit.
- If more than 30 seconds elapse between pressing the Broil pad and the Autoset pad, the oven will not be set and the display will return to the previous display.
- HI is used for most broiling. Use LO broil when broiling longer cooking foods. The lower temperature allows food to cook to the well done stage without excessive browning.
- Most foods should be turned halfway through broiling time.
- For additional broiling tips and temperatures, refer to the "Cooking Made Simple" booklet.

Broiling Chart - Broil times are based on a 4 minute preheat.

FOODS	UPPER OVEN RACK POSITION*	LOWER OVEN RACK POSITION*	SETTING	UPPER OVEN COOK TIME (MINUTES)**	LOWER OVEN COOK TIME (MINUTES)**
Beef					
Steak, 1" thick,	on rack	4	HI	8 - 11 (medium)	15 - 19 (medium)
4 oz. Hamburgers, 3/4" thick (up to 12)	on rack	4	HI	15 - 20 (well)	15 - 19 (well)
4 oz. Hamburgers, 3/4" thick (up to 6)	on rack	4	HI	12 - 16 (well)	15 - 19 (well)
Chicken					
Bone-in, skin-on breast Pieces	on rack	3 or 4	LO	25 - 36 (well)	28 - 39 (well)
Fish					
Filets	on rack	4	LO	8 - 12 (flaky)	8 - 13 (flaky)
Steaks, 1" thick	on rack	4	LO	10 - 14 (flaky)	10 - 16 (flaky)
Pork					
Chops, 1" thick	on rack	4	HI	18 - 24 (well)	22 - 27 (well)

* When broiling fish, spray broil pan insert with cooking oil. Do not turn fish filets.

** Broiling times are approximate and may vary depending on the thickness of the food.

OVEN COOKING

Keep Warm

For safely keeping hot foods warm or for warming breads and plates.

To set Keep Warm:

- Press the appropriate Keep Warm pad.
 - WARM flashes.
 - 000 and either UPPER or LOWER flashes in the display.
- Select the Keep Warm temperature. Press the Autosest pad or the appropriate number pads.
 - 170° will light when the Autosest pad is pressed.
 - Each press of the Autosest pad will increase the temperature by 5°.

The Keep Warm temperature can be set from 145° to 190°, WARM and the temperature will be displayed while the function is active.



To cancel Keep Warm:

- Press the appropriate Cancel pad.
- Remove food from the oven.

Keep Warm Notes:

- For optimal food quality, oven cooked foods should be kept warm for no longer than 1 to 2 hours.
- To keep foods from drying, cover loosely with foil or a lid.
- To warm dinner rolls:**
 - cover rolls loosely with foil and place in oven.
 - press Keep Warm and Autosest pads.
 - warm for 12-15 minutes.
- To warm plates:**
 - place 2 stacks of up to four plates each in the oven.
 - press Keep Warm and Autosest pads.
 - warm for 5 minutes, turn off the oven and leave plates in the oven for 15 minutes more.
 - use only oven-safe plates, check with the manufacturer.
 - do not set warm dishes on a cold surface as rapid temperature changes could cause crazing or breakage.

Toasting (upper oven only)

For toasting bread and products that are toasted in a toaster or toaster oven.

- Press the Toast pad.
- Press the Autosest pad to set 4 minutes of toasting time. Each additional press will increase the toasting time by 1 minute. TOAST and UPPER will be displayed and the toasting time will begin to count down.

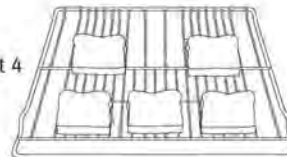

Or, press the appropriate number pads to set the toasting time in minutes and seconds between 10 seconds and 6 minutes.

- Example:** To set toasting time for two minutes, press 2, 0, 0.
- Browning time may vary, watch toasting carefully to avoid over-browning. Close oven door during toasting.
- At the end of the set toasting time, the oven will beep four times.

Toasting Notes:

- Lower oven may not be operated while upper oven is toasting. If the lower oven is operating when the Toast pad is pressed, a beep will sound.**
- Toasting is based on time not temperature.
- For more even browning results, preheat the oven 3-4 minutes.
- Toasting times will be shorter when the oven is hot or when repeated toasting functions are done.
- For optimal results when toasting 4-5 pieces of bread or other similar items, follow illustration above.

Toasting Chart

FOOD	TOAST TIME*/COLD START
Sliced White Bread	3½ - 4½ min.
Waffles (frozen)	4 - 4½ min.
Toaster Pastry (unfrozen)	3½ - 4 min.
Toaster Pastry (frozen)	4½ - 4¾ min.
Tortillas (flour)	2½ - 3 min.
Toaster Breaks** or Hot Pockets**	4 - 5 min.
Bagels	4½ - 5 min.
English Muffins	3½ - 4 min.
Cheese Sandwich	3½ - 4½ min.

- * Toasting times are approximate and should be used as a guide only.
- ** Brand names are registered trademarks of the respective manufacturers.

OVEN COOKING

Proofing (lower oven only)

For proofing or allowing yeast bread products to rise prior to baking. There are two proofing methods available: STANDARD and QUICK.

Standard Proofing temperature is slightly higher than room temperature, protecting dough from temperature changes and drafts that can affect proofing results.

Quick Proofing provides faster results than countertop or standard proofing, without harming the yeast.

1. Press the Proofing pad.

- SET flashes in the display.

Proofing

2. Press the AutoseT pad for Standard Proof (Std appears), press again for Quick Proof (rPd appears).

3. When proofing is complete, press the Lower Cancel pad.

Lower Cancel

Proofing Notes:

- For any dough that requires one rise, either Standard or Quick Proofing can be used.
- For dough requiring two rises, Standard Proofing must be used for the first rising period. Either Standard or Quick Proofing can be used for the second rise.

Drying (lower oven only)

For best results, use a drying rack. A drying rack allows air to circulate evenly around the food.

The convection fan will operate during the drying procedure.

To set Drying:

1. Place food in the oven.
2. Press the Drying pad.
 - DRY and 000 flash in the display.
3. Press the AutoseT pad for 140° F or press the appropriate number pads for the desired drying temperature.
 - Pressing the AutoseT pad will increase the temperature in 10° increments.
 - The temperature may be set between 100° - 200° F.
4. After four seconds, LOWER, DRY and the set temperature will appear in the display.
5. The oven door needs to be opened slightly to allow moisture to escape from the oven during the drying process.

- Open the oven door slightly.
- Place the magnetic door spacer (Part No. 8010P146-60) over the plunger switch at the upper right side of the oven frame. The spacer provides a gap between the oven frame and the oven door to allow moisture to escape.

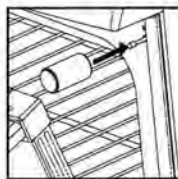

Drying

- Gently close the door until the spacer magnet makes contact with the oven door. The magnet will hold the spacer in the proper position during the drying process and allows the door to be opened at any time during drying without losing proper positioning.

Note: If the spacer is not placed correctly, the convection fan will not operate.

6. When drying is complete, turn the oven off by pressing the Lower Cancel pad. Using a potholder, remove the magnetic spacer.

Lower Cancel

Note: Please keep the magnetic spacer in a safe and convenient place for easy access. To replace, call 1-800-JENNAIR to order Part No. 8010P146-60.

Follow the Drying Guide on page 15 for drying times. Check foods at minimum times given. Cool foods to room temperature before testing for doneness.

Drying Notes:

- To purchase a drying rack, contact your Jenn-Air dealer for the "DRYINGRACK" Accessory Kit or call 1-800-JENNAIR.
- Most fruits and vegetables dry well and retain their color when dried at 140° F. Meat and jerky should be dried at 145° - 150° F. For optimal flavor, dry herbs at 100° F, however, at this lower temperature expect extended drying times of up to 8 hours.
- The length of drying times vary due to the following: Water and sugar content of food, size of food pieces, amount of food being dried, humidity in the air.
- Check foods at the minimum drying time. Dry longer if necessary.
- Fruits that turn brown when exposed to air should be treated with an antioxidant. Try one of the following methods:
 1. Dip fruit in a mixture of two parts bottled lemon juice to one part cool water.
 2. Soak fruit in a solution of 1 tsp. ascorbic acid or commercial antioxidant to 1 quart of cold water.
- Foods may drip during the drying process. After drying high acid or sugary foods, clean the oven bottom with soap and water. The porcelain oven finish may discolor if acidic or sugary food soils are not wiped up prior to high heat or a self-cleaning cycle.
- More than one rack of food may be dried at the same time. However, additional drying time is needed.
- Refer to other resources at your local library or call your local County Extension service for additional information.

OVEN COOKING

Automatic Shut-Off/Sabbath Mode

The ovens will automatically turn off after 12 hours if you accidentally leave them on.

To cancel the 12-hour shut-off and run the ovens continuously for 72 hours:

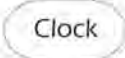
1. Press and hold the Clock pad for three seconds. 
 - "SAb" will be displayed and flash for five seconds.
 - "SAb" will then be displayed continuously until turned off or until the 72-hour time limit is reached.
 - BAKE will also be displayed if a bake cycle is in use while the oven is in Sabbath Mode.
 - All pads are inactive except Cancel and Clock. All other functions EXCEPT BAKE (Timer, Keep Warm, Clean, etc.) are locked out during the Sabbath Mode.

To cancel the Sabbath Mode:

1. Press the Clock pad for three seconds.
 - "SAb" will flash for five seconds.
 - The time of day will return to the display.
- OR
2. After 72 hours, the Sabbath Mode will end. 
 - "SAb" will flash for five seconds.
 - The time of day will return to the display.

Favorite

The Favorite pad allows you to save the time and temperature from a Cook & Hold Bake, Cook & Hold Convection Bake or Cook & Hold Convection Roast (lower oven only) cycle.

To set a Favorite cycle, a Cook & Hold function must be either active or just programmed.

To set a new Favorite cycle or to save a currently running Cook & Hold as a Favorite:

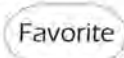
1. Program a Cook & Hold cycle as described in the Cook & Hold section on page 11.
2. Press and hold the Favorite pad for three seconds. 
 - The newly set or currently running Cook & Hold cycle will be saved.
 - A double then single beep will sound to indicate that the control has accepted the Favorite setting.

To start a cycle programmed into Favorite:

1. Press the Favorite pad.
 - Time and temperature for the set Cook & Hold feature will be displayed. (If no Cook & Hold cycle has been programmed, "nonE" is displayed.)
2. Press the Bake, Convection Bake or Convection Roast (lower oven only) pad.
 - The Favorite function will begin immediately.
 - The selected function and cooking time will light in the display.

When the cooking time has elapsed:

- The selected function will turn off.
- WARM HOLD will light and 170° will display.

To cancel a Favorite cycle in progress:

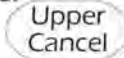
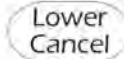
1. Press the appropriate Cancel pad. 
2. Remove food from the oven. 
 - The stored Favorite cycle will not be affected.

Sabbath Mode Notes:

- Sabbath Mode can be turned on at any time with or without the ovens on.
- Sabbath Mode cannot be turned on if the keypads are locked out or when the doors are locked.
- Most prompts and messages and all beeps are deactivated when Sabbath Mode is active.
- If an oven is baking when Sabbath Mode is set, BAKE will go out at the end of the baking cycle or when the Cancel pad is pressed. There will be no audible beeps.
- If the oven lights are desired while in Sabbath Mode, they must be turned on before the Sabbath Mode is started.
- When the Sabbath Mode is started, the temperature display will immediately show the set temperature, rather than the actual oven cavity temperature. No preheat beep will sound.
- The self-clean cycle and automatic door lock do not operate during the Sabbath Mode.
- Pressing a Cancel pad will cancel a Bake cycle, however the control will stay in the Sabbath Mode.
- If power fails, the ovens will power up in Sabbath Mode with 72 hours remaining and no cycle active.

OVEN COOKING

Adjusting the Oven Temperature

Oven temperatures are carefully tested for accuracy at the factory. It is normal to notice some baking or browning differences between a new oven and an old one. As ovens get older, the oven temperature can shift.

You may adjust the oven temperature if you think the oven is not baking or browning correctly. To decide how much to change the temperature, set the temperature 25 degrees higher or lower than your recipe recommends, then bake. The results of the first bake should give you an idea of how much to adjust the temperature.

To adjust the oven temperature:

1. Press the Bake pad for the appropriate oven. **Bake**
2. Enter 550° by pressing the appropriate number pads.
3. Press and hold the Bake pad for several seconds or until 00° appears in the display.

If the oven temperature was previously adjusted, the change will be displayed. For example, if the oven temperature was reduced by 15° the display will show "-15°".

4. Press the Autoset pad to adjust the temperature.

Each time the Autoset pad is pressed, the temperature changes by 5°. The oven temperature can be increased or decreased by 5° to 35°.

5. The time of day will automatically reappear in the display.

You do not need to readjust the oven temperature if there is a power failure or interruption. Temperature adjustment applies to Bake, Convection Bake and Convection Roast (lower oven only) only.

Oven Fan

A convection fan is used to circulate hot air in the oven when the convection feature is selected. It automatically turns on after the Convection Bake or Convection Roast pads are pressed and will turn off when convection is canceled.

Note: The convection fans will automatically stop when the oven door is opened.

Oven Vent

When the oven is in use the area near the vent may become hot enough to cause burns. Never block the vent opening.

The oven vent is located below the backguard vent shield on your range.

When high moisture foods are cooked in the upper oven, steam may be visible coming from the oven vent. This is normal.

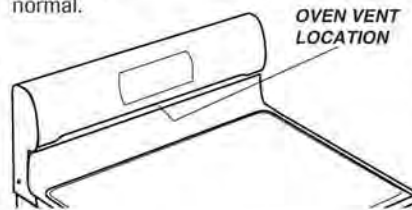

Do not place plastics near the vent opening as heat from the vent could distort or melt the plastic.

Oven Lights

The oven lights automatically come on when an oven door is opened. When the door is closed, press the appropriate Oven Light pad to turn the oven light on and off. A beep will sound every time the Oven Light pad is pressed.

Oven Light

Oven Bottom

Protect oven bottom against spillovers, especially acidic or sugary spills, as they may discolor the porcelain enamel. Use the correct pan size to avoid spillovers and boilovers. **Do not place utensils or aluminum foil directly on the oven bottom.**

Oven Racks

⚠ CAUTION

- Do not attempt to change the rack position when the oven is hot.
- Do not use the oven for storing food or cookware.

All racks are designed with a lock-stop edge.

Upper oven

- Is equipped with one rack.
- When pulling the upper oven rack out to remove or check food, grasp the **top edge** of the rack.



Lower oven

- Is equipped with one RollerGlide™ rack, one half-rack and one regular flat rack.

OVEN COOKING

To remove oven racks:

- Pull rack straight out until it stops at the lock-stop position; lift up on the front of the rack and pull out.
- For RollerGlide™ rack, pull both the rack glide and rack base out together.

To replace oven racks:

- Place rack on the rack support in the oven; tilt the front end up slightly; slide rack back until it clears the lock-stop position; lower front and slide back into the oven.



Baking and Roasting with the RollerGlide™ Rack (lower oven only)

Baking

- For optimal baking results when baking on one rack, use the RollerGlide™ rack.
- When baking on two racks, use the RollerGlide™ rack in the bottom rack position, and the flat rack in the upper rack position.

Roasting

- When roasting large cuts of meat and poultry, use the telescoping rack for ease of movement.

Rack Positions (lower oven)

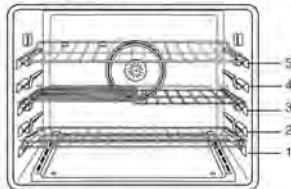

RACK 5: Use for toasting bread or broiling very thin foods or two-rack baking.

RACK 4: Use for two-rack baking and for broiling.

RACK 3: Use for most baked goods on a cookie sheet or jelly roll pan, layer cakes, fruit pies, or frozen convenience foods and for broiling.

RACK 2: Use for roasting small cuts of meat, casseroles, baking loaves of bread, bundt cakes or custard pies and two-rack baking.

RACK 1: Use for roasting large cuts of meat and poultry, frozen pies, dessert souffles or angel food cake and two-rack baking.

MULTIPLE RACK COOKING:

Two rack: Use rack positions 2 and 4, 1 and 4, or 2 and 5.

Three rack: Use rack positions 1, 3 and 5.

Baking Layer Cakes on Two Racks

For best results when baking cakes on two racks, use racks 2 and 4.

Place the cakes on the rack as shown.

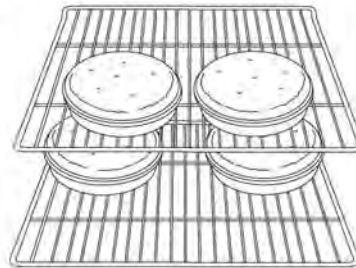

Create-A-Space™ Half Rack

(lower oven only)

The range is equipped with a convertible half rack. The left side of the rack can be removed to accommodate a large roaster on the lower rack. The right side of the rack is still available to hold a casserole dish.



Notes:

- The removable section of the rack can be used as a roasting rack in the broiling pan. Do not use the broiler insert when using the rack in the broiling pan.
- The removable section of the rack can be used as a cooling rack or trivet.
- Make sure oven is cool before removing or reinstalling the half rack.
- Do not use cookware that extends beyond edge of rack.
- For best results, allow two inches between the pan placed on the rack and the oven side wall.
- Use caution when removing items from the half rack to avoid burns.
- Carefully remove items from the lower rack to avoid disturbing the half rack.

CARE & CLEANING

Self-Clean Oven

CAUTION

- It is normal for parts of the oven to become hot during a self-clean cycle.
- To prevent damage to oven doors, do not attempt to open the doors when LOCK is displayed.
- Avoid touching door, window or oven vent area during a clean cycle.
- Do not use commercial oven cleaners on the oven finish or around any part of the oven. They will damage the finish or parts.
- **DO NOT leave baking/pizza stone in oven during self clean.**

The self-clean cycle uses above-normal cooking temperatures to automatically clean the oven interior.

It is normal for flare-ups, smoking, or flaming to occur during cleaning if the oven is heavily soiled. It is better to clean the oven regularly rather than to wait until there is a heavy build-up of soil in the oven.

During the cleaning process, the kitchen should be well ventilated to get rid of normal odors associated with cleaning.

Before Self-Cleaning



1. Turn off the oven light before cleaning as the light may burn out during the clean cycle.
2. Remove broiler pan, all pans, and oven racks from the oven. The oven racks will discolor and may not slide easily after a self-clean cycle if they are not removed.
3. Clean oven frame, door frame (area outside of gasket, and around the opening in the door gasket) with a nonabrasive cleaner such as Bon Ami* or detergent and water. The self-cleaning process does not clean these areas. They should be cleaned to prevent soil from baking on during the clean cycle. (The gasket is the seal around the oven door and window.) 
4. To prevent damage, do not clean or rub the gasket around the oven door. The gasket is designed to seal in heat during the clean cycle.
5. Wipe up excess grease or spillovers from the oven bottom. This prevents excessive smoking, flare-ups or flaming during the clean cycle.
6. Wipe up sugary and acidic spillovers such as sweet potatoes, tomato, or milk-based sauces. Porcelain enamel is acid-

resistant, not acid-proof. The porcelain finish may discolor if acidic or sugary spills are not wiped up before a self-clean cycle.

Notes:

- Oven temperature must be below 400° F to program a clean cycle.
- **Only one oven can be cleaned at a time.**
- Both oven doors lock when either oven is being cleaned.

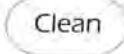

To set Self-Clean:

1. Close the oven door. 
2. Press the appropriate Clean pad.
 - CLEAN flashes.
 - SET and UPPER or LOWER flash in the display. 
3. Press the Autoset pad.
 - "MEd" (Medium Soil, 3 hours) is displayed.
4. Press the Autoset pad to scroll through the self-cleaning settings.
 - "HVy" (Heavy Soil, 4 hours)
 - "MEd" (Medium soil, 3 hours)
 - "LITE" (Light Soil, 2 hours)

Choosing the soil level of the oven automatically programs the self-cleaning time.

5. After four seconds, the oven will start cleaning.
 - If the door is not closed, beeps will sound and 'door' will display. If the door is not closed within 30 seconds, the self-cleaning operation will be canceled and the display will return to the time of day.
 - CLEAN will appear in the display.
 - LOCK will flash in the display. Once the door locks, LOCK will remain steady.
 - The cleaning time will start counting down in the display.

To Delay a Self-Clean Cycle:

1. Press the Delay pad **once** for upper oven or **twice** for lower oven. 
 - DELAY flashes.
 - 00:00 and UPPER or LOWER will flash in the display.
2. Enter the amount of time you want to delay the cycle using the appropriate number pads.
3. Press the appropriate Clean pad. 
 - SET flashes in the display.

* Brand names for cleaning products are registered trademarks of the respective manufacturers.

CARE & CLEANING

4. Press the Autoseal pad.

- "LITE" (Light soil level) is displayed.

Autoseal

5. Press the Autoseal pad to scroll through the self-cleaning settings.

"HVy" (Heavy Soil, 4 hours)

"MEd" (Medium Soil, 3 hours)

"LITE" (Light Soil, 2 hours)

Choosing the soil level of the oven automatically programs the self-cleaning time.

6. After four seconds, CLEAN, DELAY and UPPER or LOWER will light and LOCK will flash in the display. When the oven door latches, LOCK will stop flashing and light continuously to show that the oven is set for a delayed clean operation. The delay time will display.

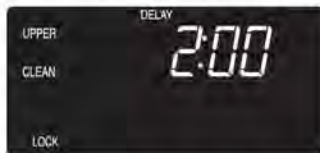

During the Self-Clean Cycle

When LOCK shows in the display, both oven doors lock. To prevent damage to the doors, do not force the doors open when LOCK is displayed.

Smoke and Smells

You may see some smoke and smell an odor the first few times the oven is cleaned. This is normal and will lessen in time.

Smoke may also occur if the oven is heavily soiled or if a broiler pan was left in the oven.

Sounds

As the oven heats, you may hear sounds of metal parts expanding and contracting. This is normal and will not damage the oven.

After Self-Cleaning

About one hour after the end of the self-clean cycle, LOCK will turn off. The doors can then be opened.

Some soil may leave a light gray, powdery ash. Remove it with a damp cloth. If soil remains after wiping, that means the clean cycle was not long enough. The soil will be removed during the next clean cycle.

If oven racks were left in the oven and do not slide smoothly after a clean cycle, wipe racks and rack supports with a small amount of vegetable oil to make them easier to move.

Fine lines may appear in the porcelain because it went through heating and cooling. This is normal and will not affect performance.

A white discoloration may appear after cleaning if acidic or sugary foods were not wiped up before the self-clean cycle. This discoloration is normal and will not affect performance.

Self-Clean Notes:

- If an oven door is left open, "door" will appear in the display and a signal will beep until the door is closed and the Clean pad is pressed again.
- If more than 30 seconds elapse between pressing the Clean pad and the Autoseal pad, the program will automatically return to the previous display.
- The oven doors will be damaged if the oven doors are forced to open when LOCK is still displayed.

Cleaning Procedures

CARE & CLEANING

Cleaning Procedures

CAUTION

- Be sure appliance is off and all parts are cool before handling or cleaning. This is to avoid damage and possible burns.
- To prevent staining or discoloration, clean appliance after each use.
- If a part is removed, be sure it is correctly replaced.

* Brand names are registered trademarks of the respective manufacturers.

** To order call 1-800-JENNAIR (1-800-536-6247).

PART	PROCEDURE
Broiler Pan and Insert	<p><i>Never cover insert with aluminum foil as this prevents the fat from draining to the pan below.</i></p> <ul style="list-style-type: none"> • Place soapy cloth over insert and pan; let soak to loosen soil. • Wash in warm soapy water. Use scouring pad to remove stubborn soil. • Broiler pan and insert can be cleaned in dishwasher.
Burner Caps and Sealed Gas Burners	<p>Removable Burner Heads</p> <ul style="list-style-type: none"> • Allow burner to cool. Remove burner cap and wash in soapy water with a plastic scouring pad. For stubborn soils, clean with a soap-filled, nonabrasive pad or Cooktop Cleaning Creme* (Part #20000001)** and a sponge. • Do not clean in the dishwasher or self-cleaning oven. <p>Sealed Gas Burners</p> <ul style="list-style-type: none"> • Clean frequently. Allow burner to cool. Clean with soap and plastic scouring pad. For stubborn soils, clean with a soap-filled, nonabrasive pad. Do not enlarge or distort holes. • Be careful not to get water into burner ports. • Use care when cleaning the ignitor. If the ignitor is wet or damaged the surface burner will not light.
Burner Grates - Porcelain on Cast Iron	<ul style="list-style-type: none"> • Wash with warm, soapy water and a nonabrasive, plastic, scrubbing pad. For stubborn soils, clean with a soap-filled, nonabrasive, plastic pad or Cooktop Cleaning Creme* (Part #20000001)** and a sponge. If soil remains, reapply Cooktop Cleaning Creme, cover with a damp paper towel and soak for 30 minutes. Scrub again, rinse and dry. • Do not clean in the dishwasher or self-cleaning oven.
Clock and Control Pad Area	<ul style="list-style-type: none"> • To activate "Control Lock" for cleaning, see page 8. • Wash, rinse and dry. Do not use abrasive cleaning agents as they may scratch the finish. • Glass cleaners may be used if sprayed on a cloth first. DO NOT spray directly on control pad and display area.
Control Knobs	<ul style="list-style-type: none"> • Remove knobs in the OFF position by pulling up. • Wash, rinse and dry. Do not use abrasive cleaning agents as they may scratch the finish. • Turn on each burner to be sure the knobs have been correctly replaced.
Backguard, Cooktop and Control Panel - Porcelain Enamel	<p>Porcelain enamel is glass fused on metal and may crack or chip with misuse. It is acid resistant, not acid proof. All spillovers, especially acidic or sugary spillovers, should be wiped up immediately with a dry cloth.</p> <ul style="list-style-type: none"> • When cool, wash with soapy water, rinse and dry. • Never wipe off a warm or hot surface with a damp cloth. This may cause cracking or chipping. • Never use oven cleaners, abrasive or caustic cleaning agents on exterior finish of range.
Side Panels, Painted Enamel	<ul style="list-style-type: none"> • When cool, wash with warm soapy water, rinse and dry. Never wipe a warm or hot surface with a damp cloth as this may damage the surface and may cause a steam burn. • For stubborn soil, use mildly abrasive cleaning agents such as baking soda paste or Bon Ami*. Do not use abrasive cleaners such as steel wool pads or oven cleaners. These products will scratch or permanently damage the surface. <p>Note: Use a dry towel or cloth to wipe up spills, especially acidic or sugary spills. Surface may discolor or dull if soil is not immediately removed. This is especially important for white surfaces.</p>

Cleaning Procedures

CARE & CLEANING

PART	PROCEDURE
Oven Windows and Doors - Glass	<ul style="list-style-type: none"> • Avoid using excessive amounts of water which may seep under or behind glass causing staining. • Wash with soap and water. Rinse with clear water and dry. Glass cleaner can be used if sprayed on a cloth first. • Do not use abrasive materials such as scouring pads, steel wool or powdered cleaners as they will scratch glass.
Oven Interior	<ul style="list-style-type: none"> • Follow instructions on page 19-20 to set a self-clean cycle.
Oven Racks	<ul style="list-style-type: none"> • Clean with soapy water. • Remove stubborn soil with cleansing powder or soap-filled scouring pad. Rinse and dry. • Racks will permanently discolor and may not slide out smoothly if left in the oven during a self-clean operation. If this occurs, wipe the rack and embossed rack supports with a small amount of vegetable oil to restore ease of movement, then wipe off excess oil.
Stainless Steel (select models)	<ul style="list-style-type: none"> • DO NOT USE ANY CLEANING PRODUCT CONTAINING CHLORINE BLEACH. • DO NOT USE ABRASIVE OR ORANGE CLEANERS. • ALWAYS WIPE WITH THE GRAIN WHEN CLEANING. • Daily Cleaning/Light Soil -- Wipe with one of the following - soapy water, white vinegar/water solution, Formula 409 Glass and Surface Cleaner* or a similar glass cleaner - using a sponge or soft cloth. Rinse and dry. To polish and help prevent fingerprints, follow with Stainless Steel Magic Spray* (Part No. 20000008)**. • Moderate/Heavy Soil -- Wipe with one of the following - Bon Ami*, Smart Cleanser*, or Soft Scrub* - using a damp sponge or soft cloth. Rinse and dry. Stubborn soils may be removed with a damp Scotch-Brite* pad; rub evenly with the grain. Rinse and dry. To restore luster and remove streaks, follow with Stainless Steel Magic Spray*. • Discoloration -- Using a damp sponge or soft cloth, wipe with Cameo Stainless Steel Cleaner*. Rinse immediately and dry. To remove streaks and restore luster, follow with Stainless Steel Magic Spray*.

* Brand names for cleaning products are registered trademarks of the respective manufacturers.

** To order direct, call 1-800-JENNAIR (1-800-536-6247).

Appendix C

LP Conversion Instructions

Part No. 8101P619-60

This range is equipped with fixed orifices on all burners and a convertible appliance pressure regulator. The unit serial plate states which gas it was adjusted for at the factory. To convert the unit to either Natural gas or LP gas will require replacement of the oven orifice hoods, the air shutters on the oven burners, and the top burner orifices, and adjustment of the appliance pressure regulator converter cap./Cette cuisinière est équipée de gicleurs fixes sur tous les brûleurs et d'un détendeur convertible. La plaque signalétique de l'appareil indique avec quel gaz l'appareil a été mis au point à l'usine. Pour convertir l'appareil à un fonctionnement au gaz naturel ou au GPL, il faut remplacer les têtes de gicler des fours, les obturateurs d'air sur les brûleurs de four et les gicleurs des brûleurs de surface. Il faut aussi ajuster le chapeau du convertisseur du détendeur de l'appareil./Esta estufa viene equipada con orificios fijos en todos los quemadores y con un regulador de presión convertible para electrodomésticos. La placa de serie de la unidad indica cuál es el ajuste de fábrica de gas. Para convertir la unidad a gas natural o a gas LP es necesario reemplazar las tapas de los orificios del horno, los obturadores de los quemadores del horno y los orificios de los quemadores superiores, además de ajustar la tapa del convertidor del regulador de presión del electrodoméstico.

Inlet pressure to the appliance pressure regulator should be as follows for both operation and checking of appliance pressure regulator setting:/La pression d'arrivée au détendeur de l'appareil doit être la suivante pour le fonctionnement et la vérification du réglage du détendeur :/La presión de entrada al regulador de presión debe ser la siguiente tanto para el funcionamiento normal como para verificar el ajuste del regulador de presión:

Inlet Pressure in inches of water column Pression d'arrivée en pouces à la colonne d'eau Presión de entrada en pulgadas c.d.a.	Natural Gas Gaz naturel Gas natural	LP Gas GPL Gas LP
Max./Max./Máx.	14 (36 cm)	14 (36 cm)
Min./Min./Min.	6 (16 cm)	11 (28 cm)



LP Propane Conversion Instructions

Instructions de conversion au GPL/
Instrucciones de conversión a gas LP propano

Regulator Conversion to LP/Conversion du détendeur au GPL/Conversión del regulador a gas LP

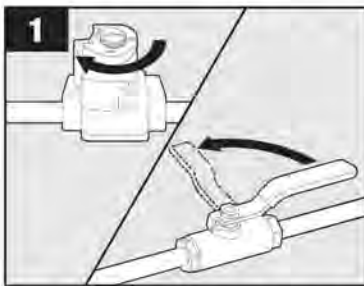

Turn off gas supply shut-off valve./Fermez le robinet d'arrêt d'alimentation en gaz./Cierre la válvula de cierre del gas.

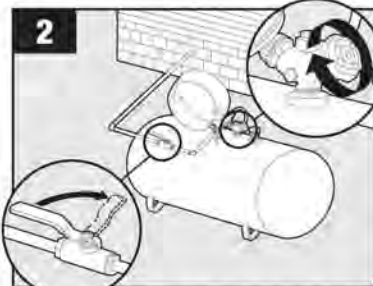

Turn off gas supply at tank./Coupez l'arrivée de gaz au réservoir./Cierre el suministro de gas en el tanque.

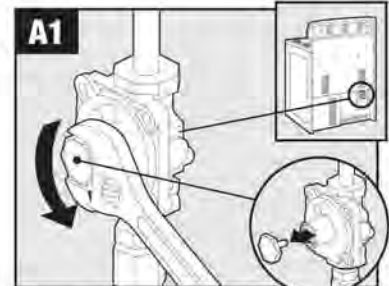

Unscrew the hex shaped cap from the neck of the regulator./Dévissez le chapeau hex. du col du détendeur./Desenrosque la tapa hexagonal del cuello del regulador.

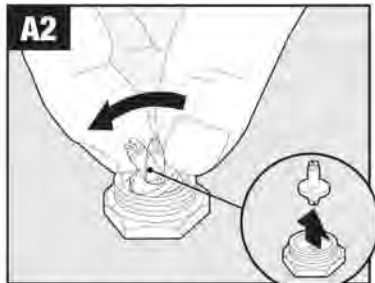

Remove pin./Enlevez la cheville./Retire el pasador.



Rotate pin and snap pin firmly into place./Tournez la cheville et enclenchez fermement la cheville en place./Gire el pasador y encájelo en su lugar.

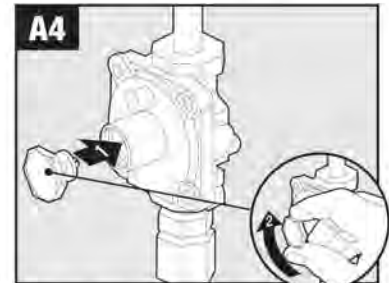

Screw the cap securely back into place. DO NOT OVER TIGHTEN./Revissez bien le chapeau. NE LE SERREZ PAS TROP FORT./Enrosque la tapa firmemente en su lugar. NO APRIETE DEMASIADO.

Conversion of lower oven to LP/Conversion du four inférieur au GPL/Conversión del horno inferior a gas LP

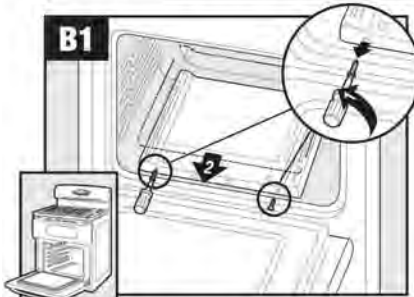

Remove oven doors/racks./Retirez les portes/grilles de four./Retire las parrillas y puertas del horno.

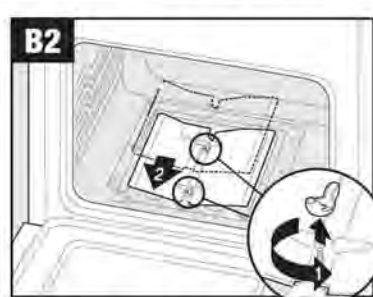

Remove oven baffle./Enlevez le déflecteur de four./Retire el deflector del horno.

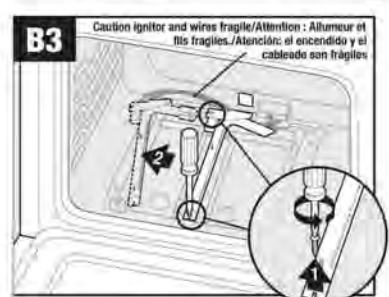

Remove burner./Enlevez le brûleur./Retire el quemador.

LP Conversion Instructions

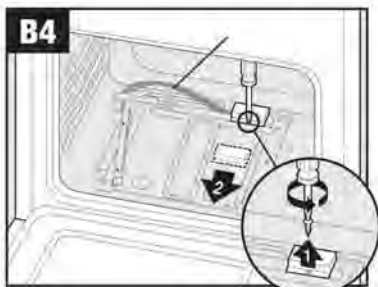

B4
Remove the cover over the orifice./Retirez le couvre-gicleur./Retire la cubierta que está sobre el orificio.

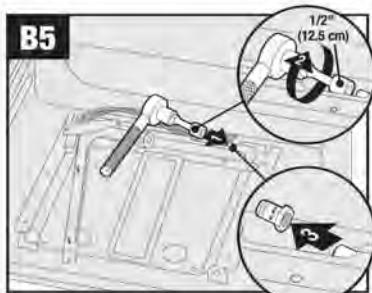

B5
Remove brass orifice hood./Retirez la tête de gicleur en laiton./Retire la tapa de bronce del orificio.

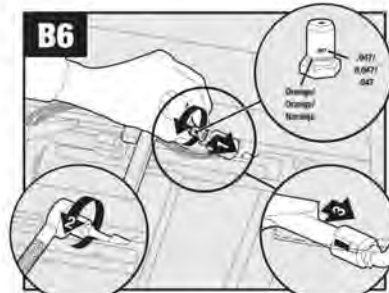

B6
Replace orifice hood. DO NOT OVER TIGHTEN./ Remettez la tête de gicleur SANS TROP LA SERRER./ Reemplace la tapa del orificio. NO APRIETE DEMASIADO.

CAUTION: Ignitor and wires are fragile./**ATTENTION :** Allumeur et fils fragiles./**ATENCIÓN:** El encendedor y el cableado son frágiles. You MUST start all hoods by hand to avoid cross threading./**Vous DEVEZ** commencer le vissage de toutes les têtes de gicleur à la main pour éviter de fausser le filetage./**Usted DEBE** iniciar el enroscado de las tapas a mano para evitar dañar las roscas.

Reverse steps B4 through B1 to reassemble lower oven./
Inversez les étapes B4 à B1 pour remonter le four inférieur./
Invierta los pasos B4 al B1 para volver a ensamblar el horno inferior.

Follow steps B1 through B6 for conversion of upper oven. (Upper oven uses a .038 Orifice)
Reverse steps B4 through B1./Suivez les étapes B1 à B6 pour convertir le four supérieur. (Le four supérieur utilise un gicleur de 0,038.)
Inversez les étapes B4 à B1./Siga los pasos B1 al B6 para realizar la conversión del horno superior. (El horno superior usa un orificio de 0,038).
Invierta los pasos B4 al B1.

Conversion of broil burner to LP/Conversion du brûleur de grill au GPL/Conversión del quemador de asar a gas LP

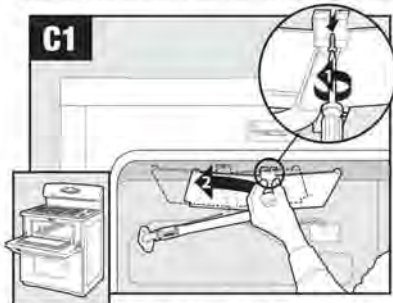

C1
Remove screw and slide the broil burner forward until the pin clears rear wall./Enlevez la vis et faites glisser en avant le brûleur de grill jusqu'à ce que le tenon se trouve dégagé de la paroi arrière./Retire el tornillo y deslice el quemador de asar hacia adelante hasta que el pasador quede libre de la pared trasera.

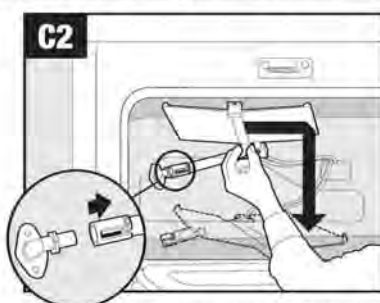

C2
Slip the burner off the brass orifice./Sortez le brûleur du gicleur en laiton./Deslice el quemador para sacarlo del orificio de bronce.

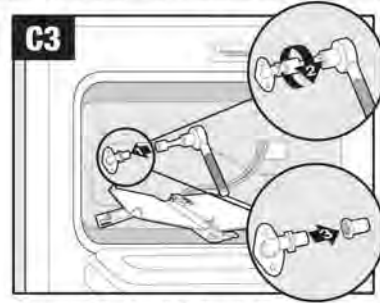

C3
Remove orifice hood./Retirez la tête de gicleur./ Retire la tapa del orificio.

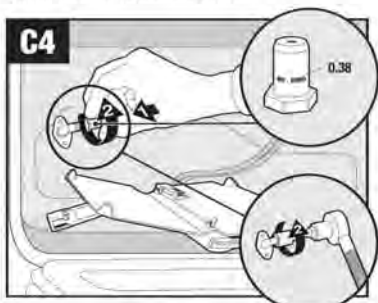

C4
Replace orifice hood. DO NOT OVER TIGHTEN./ Remettez la tête de gicleur SANS TROP LA SERRER./Reemplace la tapa del orificio. NO APRIETE DEMASIADO.

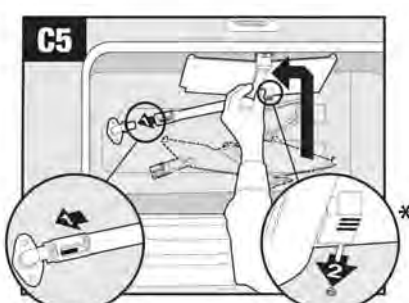

C5
Put the broil burner on the orifice hood./Mettez le brûleur de grill sur la tête de gicleur./Coloque el quemador de asar en la tapa del orificio.

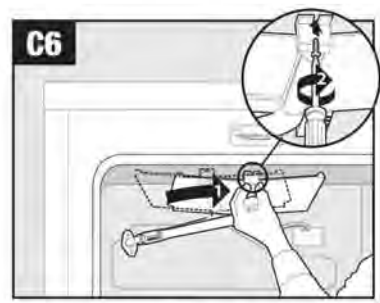

C6
Re-position the broil burner and tighten screw./ Remettez en place le brûleur de grill et serrez la vis./Vuelva a colocar el quemador de asar en su lugar y apriete el tornillo.

CAUTION:** Pin MUST be inserted into back of hole on oven to secure burners (C5)./ATTENTION :** Le tenon DOIT être introduit à l'arrière du trou du four pour bien loger les brûleurs (C5)./***ATENCIÓN:** El pasador DEBE ser introducido en la parte trasera del agujero en el horno para asegurar los quemadores (C5).

LP Conversion Instructions

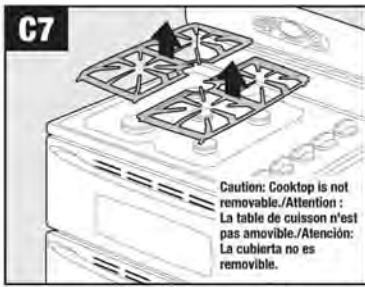

Remove the top grates./Retirez les grilles supérieures./Retire las rejillas superiores.

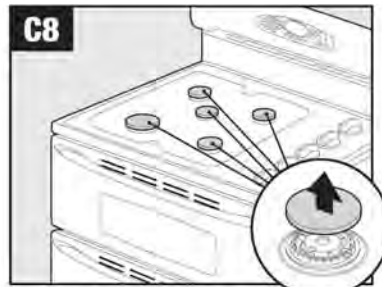

Remove the burner tops./Retirez les chapeaux de brûleur./Retire las tapas de los quemadores.

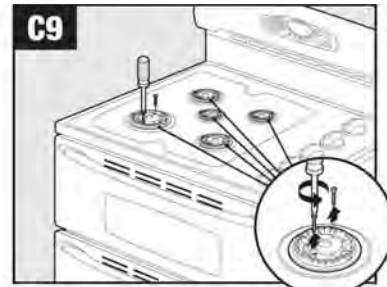

Convert one burner at a time. Remove screws from burner head./Convertissez un brûleur à la fois. Retirez les vis de la tête de brûleur./Convierta un quemador a la vez. Retire los tornillos de la cabeza del quemador.

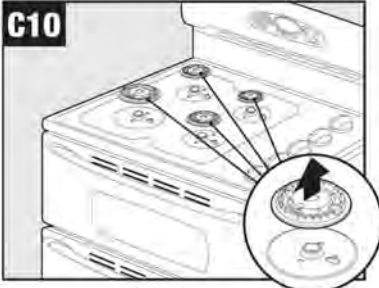

Remove burner head./Retirez la tête de brûleur./Retire la cabeza del quemador.

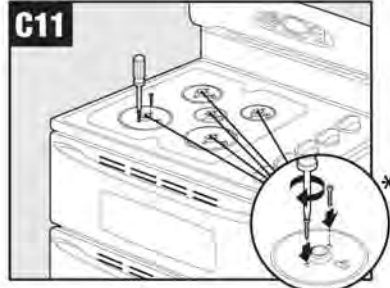

Replace screws./Remettez les vis./Reemplace los tornillos.

***IMPORTANT: Damage to gas tubing and ignitor can result from not replacing screws in C11./*IMPORTANT: Des dommages à la conduite de gaz et à l'allumeur peuvent survenir si les vis ne sont pas remises dans C11./*IMPORTANTE: Si no se colocan los tornillos en C11 se puede dañar la tubería de gas y el encendedor.**

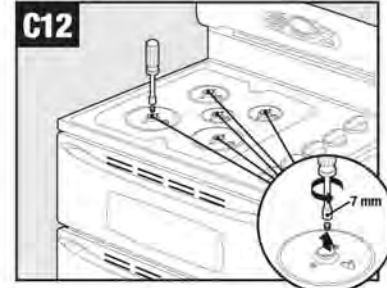

Remove orifices. Insert tape into nut driver to hold orifice. **IMPORTANT: KEEP orifices for later conversion./Enlevez les gicleurs. Mettez un bout de ruban adhésif dans le tourne-écrou pour retenir le gicleur. IMPORTANT: CONSERVEZ les gicleurs pour une conversion ultérieure./Retire los orificios. Coloque cinta adhesiva en la llave para tuercas para sostener el orificio. IMPORTANTE: GUARDE los orificios para posteriores conversiones.**

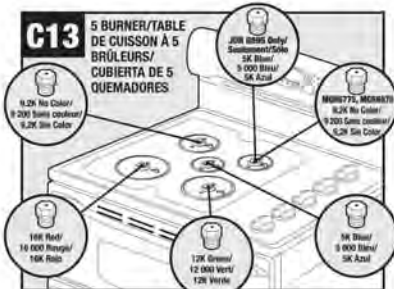

Replace with correct LP(propane) gas orifice. **DO NOT OVERTIGHTEN./Remplacez avec le bon gicleur pour GPL SANS TROP SERRER./Reemplace con los orificios de gas LP (propano) correctos. NO APRIETE DEMASIADO.**



Replace with correct LP(propane) gas orifice. **DO NOT OVERTIGHTEN./Remplacez avec le bon gicleur pour GPL SANS TROP SERRER./Reemplace con los orificios de gas LP (propano) correctos. NO APRIETE DEMASIADO.**

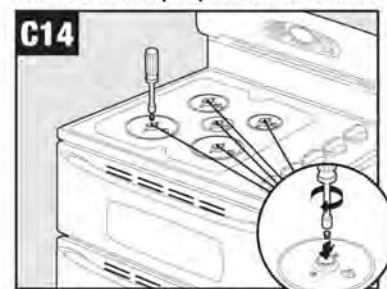

NOTE: Put tape in nut driver to secure orifice in nut driver before replacing orifice./REMARQUE: Mettez du ruban adhésif dans le tourne-écrou pour retenir le gicleur avant de le remettre en place./NOTA: Coloque cinta adhesiva en la llave para tuercas para fijarla al orificio antes de reemplazarlo.

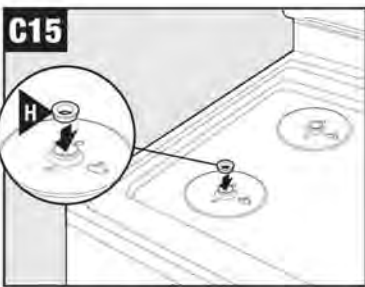

Add choke to left front orifice holder only./Ajoutez un étrangleur au support de gicleur avant gauche seulement./Agregue un obturador en el soporte del orificio delantero izquierdo únicamente.

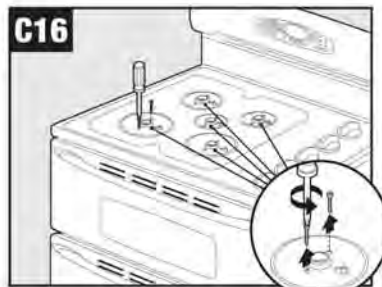

Remove screws./Enlevez les vis./Retire los tornillos.

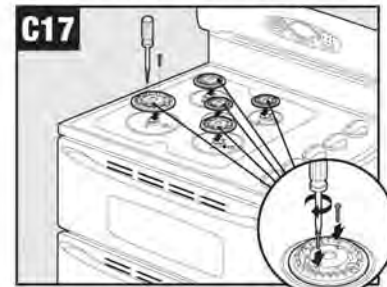

Remount burner heads./Remontez les têtes de brûleur./Vuelva a instalar las cabezas de los quemadores.

LP Conversion Instructions

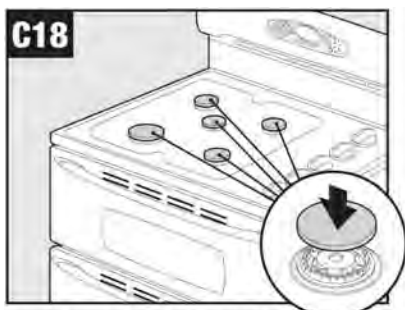

C18
 Replace burner caps./Remettez les chapeaux de brûleur./Vuelva a instalar las tapas de los quemadores.



C19
 Replace grates./Remettez les grilles./Vuelva a instalar las rejillas.

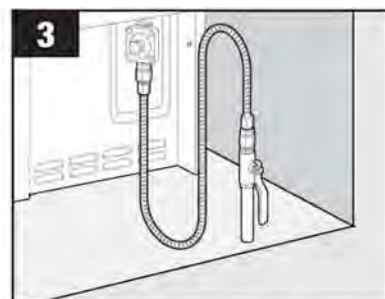

3
 Only qualified personnel should install range./
 Seul du personnel qualifié doit installer la cuisinière./La estufa sólo debe ser instalada por personal calificado.

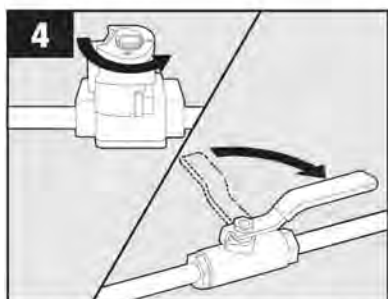

4
 Turn on gas supply shut-off valve./Ouvrez le robinet d'alimentation en gaz./Abra la válvula de cierre del gas.

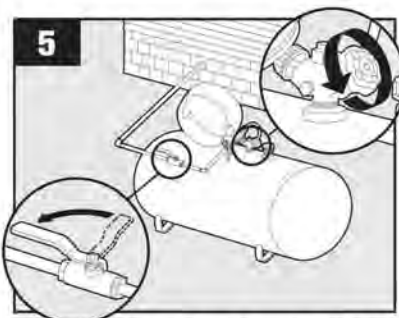

5
 Turn on gas supply at tank./Ouvrez l'arrivée de gaz au réservoir./Abra el suministro de gas en el tanque.

Low Flow Adjustment / Réglage bas débit/Ajuste del flujo mínimo

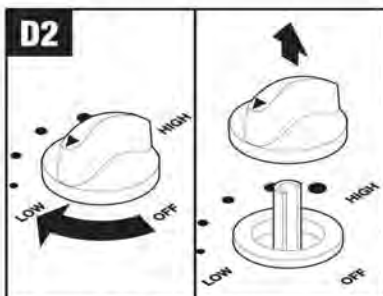
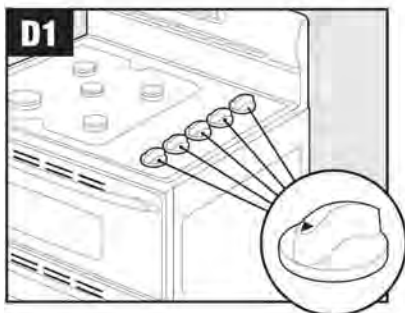

D2
 Turn burner to LOW. Remove knob./Tournez le brûleur sur LOW (BAS). Retirez le bouton./Gire la perilla al ajuste 'LOW' (Bajo). Retire la perilla.

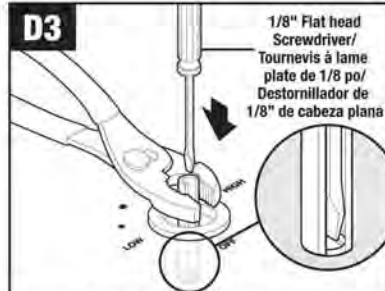

D3
 Hold knob stem in LOW position. Insert screwdriver to engage screw./Tenez la tige du bouton en position LOW. Introduisez le tournevis pour tourner la vis./Mantenga la varilla de la perilla en el ajuste 'LOW' (Bajo). Inserte el destornillador en el tornillo.

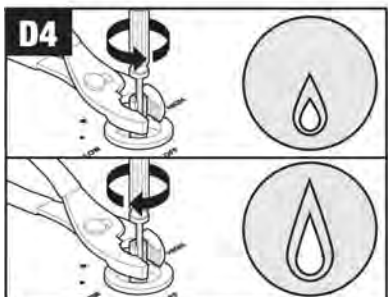

D4
 Adjust flame height with screwdriver./Ajustez la hauteur de la flamme avec le tournevis./Ajuste la altura de la llama con el destornillador.

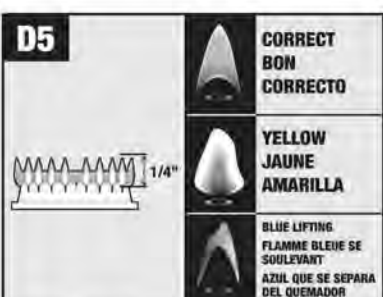

D5
 Correct flame height and appearance./Flamme de hauteur et d'aspect appropriés./Altura y apariencia correctas de la llama.

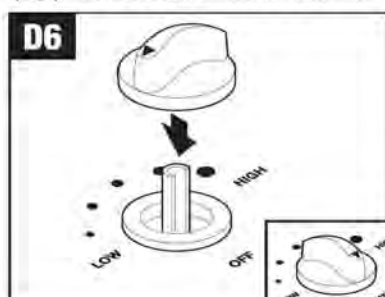

D6
 Replace knobs. Turn OFF burners./Remettez les boutons. Mettez les brûleurs sur OFF (ARRÊT)/Vuelva a instalar las perillas. APAGUE los quemadores.

NOTE: Repeat steps D1-D6 for all burners./REMARQUE : Répétez les étapes D1 à D6 pour tous les brûleurs./NOTA: Repita los pasos D1 al D6 para todos los quemadores.